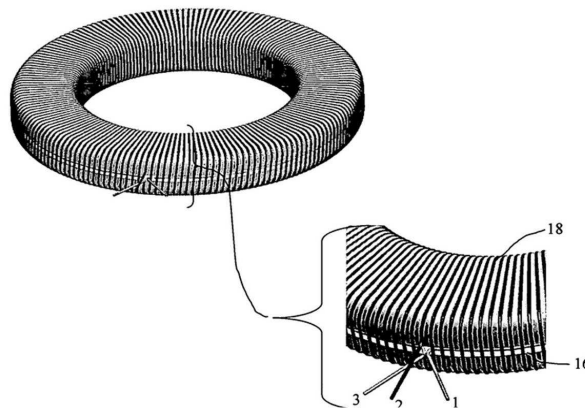
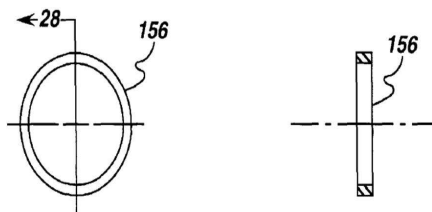

**Figure 1 (Prior-Art)**



**Figure 2 (Prior-Art)**



**Figure 3 (Prior-Art)**

*Abhishek Sen*

Abhishek Sen  
Of S. MAJUMDAR & CO.  
(Applicant's Agent)

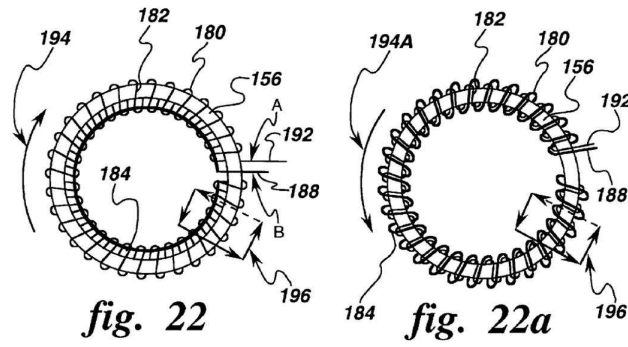

Figure 4 (Prior-Art)

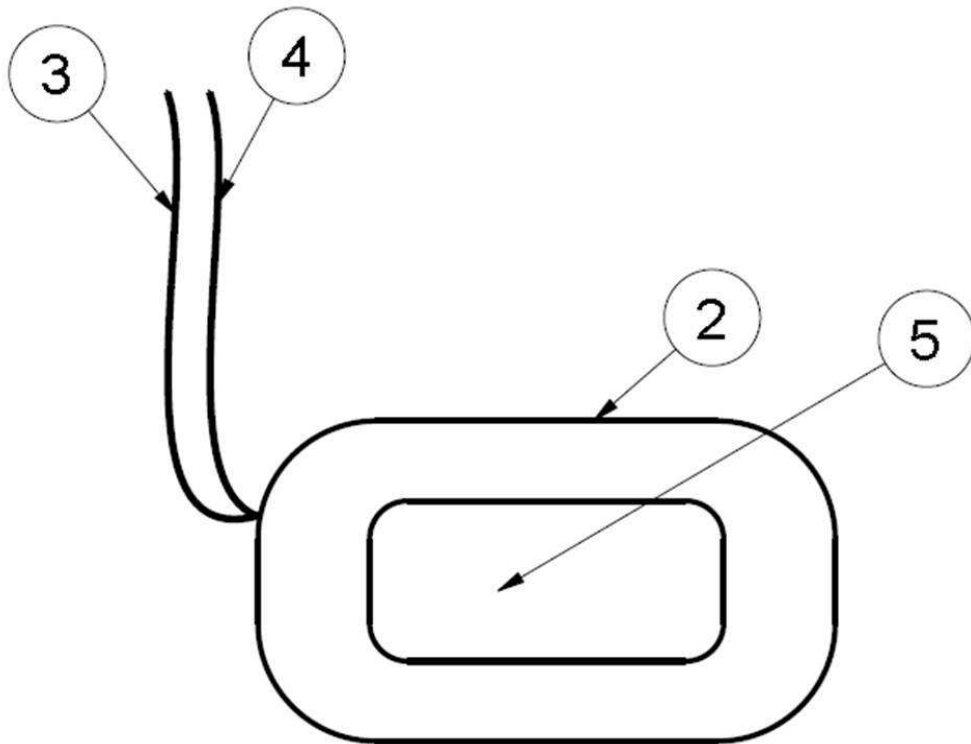
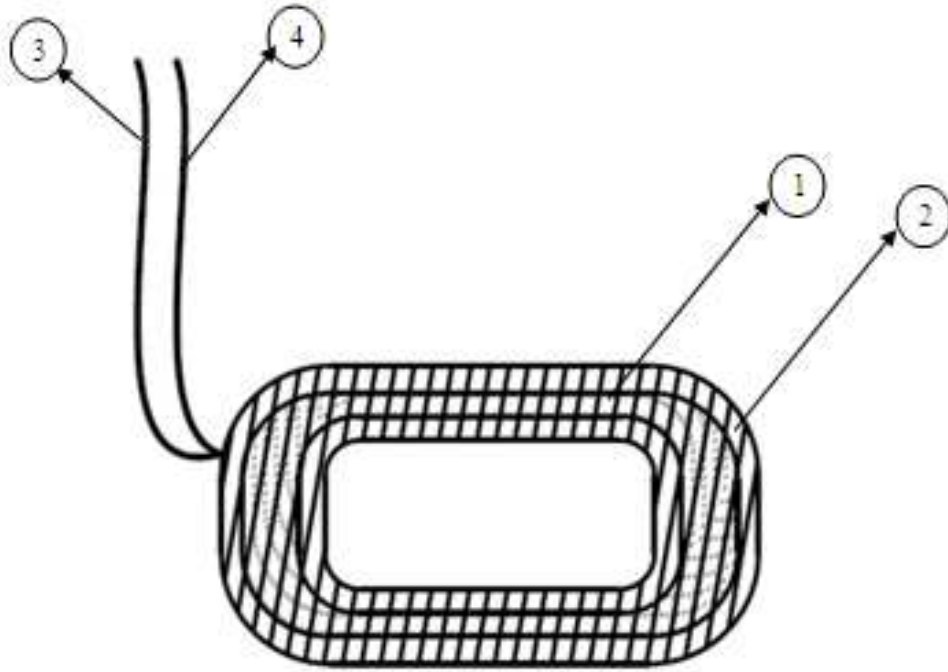

Figure 5

*Abhishek Sen*

Abhishek Sen  
Of S. MAJUMDAR & CO.  
(Applicant's Agent)



**Figure 6**

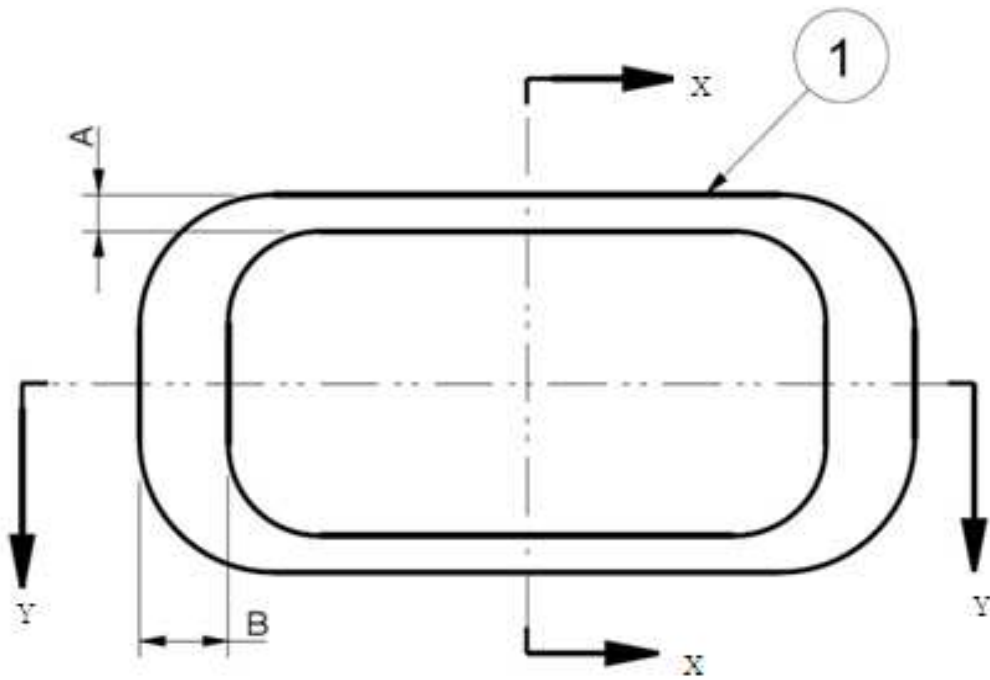

**Figure 7**

*Abhishek Sen*

Abhishek Sen  
Of S. MAJUMDAR & CO.  
(Applicant's Agent)

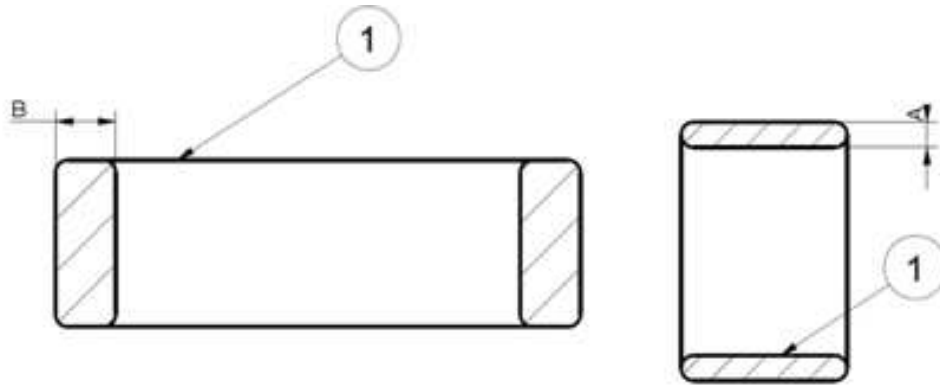

**Figure 8**

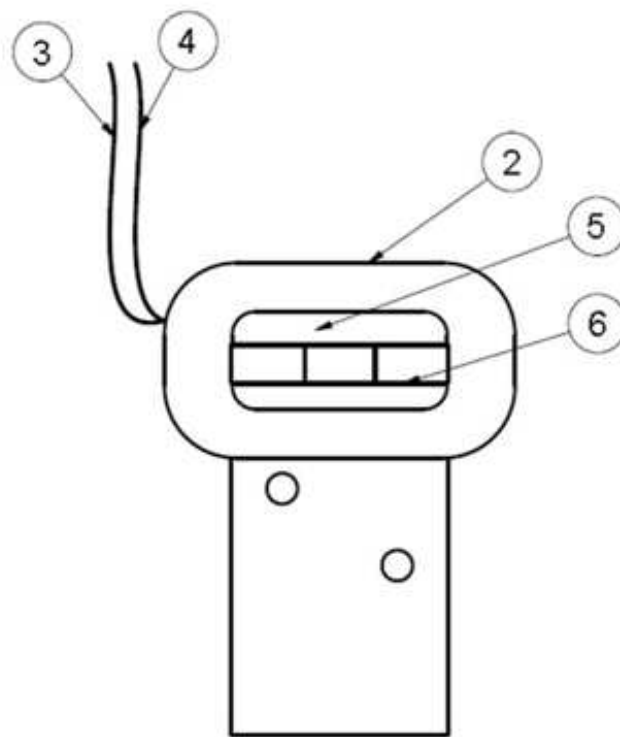

**Figure 9**

*Abhishek Sen*

Abhishek Sen  
OF S. MAJUMDAR & CO.  
(Applicant's Agent)