



US00D499397S

(12) **United States Design Patent**  
**Hlas et al.**

(10) **Patent No.:** **US D499,397 S**

(45) **Date of Patent:** **\*\* Dec. 7, 2004**

(54) **HEADSET**

(75) Inventors: **Kevin Hlas**, Portland, OR (US);  
**Michael Roberts**, Vancouver, WA (US);  
**Omer Kotzer**, Portland, OR (US);  
**Bernhard Wildner**, Portland, OR (US)

(73) Assignee: **Logitech Europe S.A.**,  
Romanel-sur-Morges (CH)

(\*\*) Term: **14 Years**

(21) Appl. No.: **29/197,047**

(22) Filed: **Jan. 7, 2004**

(51) **LOC (7) Cl.** ..... **14-01**

(52) **U.S. Cl.** ..... **D14/223**

(58) **Field of Search** ..... D14/205, 206,  
D14/223, 192; D24/174; 379/430, 446;  
381/381, 378, 379, 377, 376, 374, 330;  
181/129, 130

(56) **References Cited**

**U.S. PATENT DOCUMENTS**

4,972,492 A \* 11/1990 Tanaka et al. .... 381/380  
4,981,194 A \* 1/1991 Kamon et al. .... 181/129  
D318,473 S \* 7/1991 Miyashita et al. .... D14/223  
D331,061 S \* 11/1992 Hyohgo ..... D14/223  
D337,118 S \* 7/1993 Seikita ..... D14/223

D337,589 S \* 7/1993 Wada ..... D14/223  
D353,379 S \* 12/1994 Nakamura et al. .... D14/223  
D369,349 S \* 4/1996 Hayashi ..... D14/223  
D463,789 S \* 10/2002 DeKalb et al. .... D14/223  
D480,711 S \* 10/2003 Kuan ..... D14/223  
D485,549 S \* 1/2004 Ma et al. .... D14/223

\* cited by examiner

*Primary Examiner*—Paula A. Greene

(74) *Attorney, Agent, or Firm*—Ipsolon LLP

(57) **CLAIM**

The ornamental design for a headset, as shown and described.

**DESCRIPTION**

FIG. 1 is a bottom, perspective view of the headset;  
FIG. 2 is a top, perspective view thereof;  
FIG. 3 is a back, elevation view thereof;  
FIG. 4 is a front, elevation view thereof;  
FIG. 5 is a right side, elevation view thereof;  
FIG. 6 is a top, elevation view thereof;  
FIG. 7 is a bottom, elevation view thereof; and,  
FIG. 8 is a left side, elevation view thereof.

The broken lines showing an exemplar ear clip, wind screen, and possible installation on an ear are for illustrative purpose only and form no part of the claimed design.

**1 Claim, 1 Drawing Sheet**

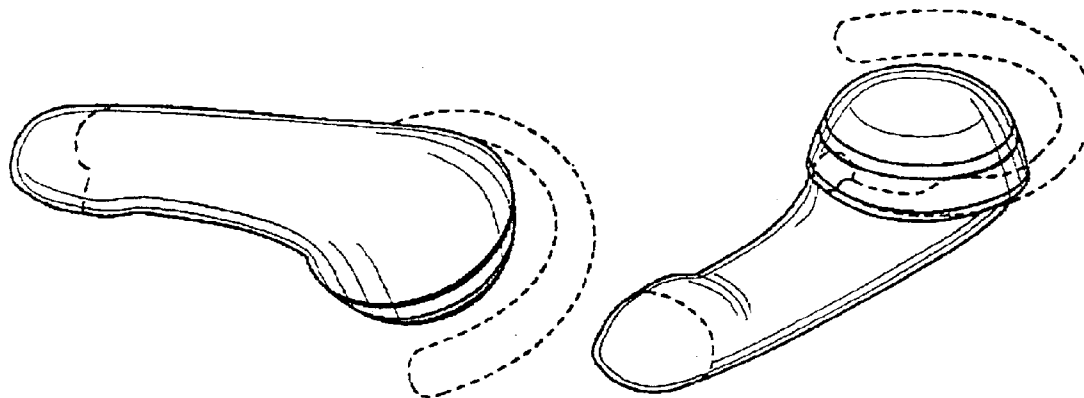

FIG. 1

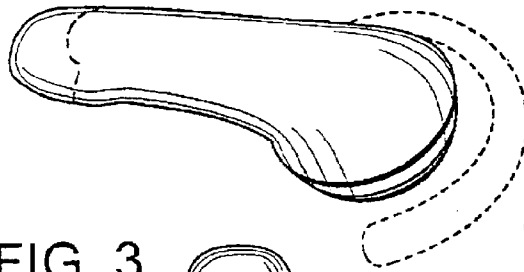

FIG. 2

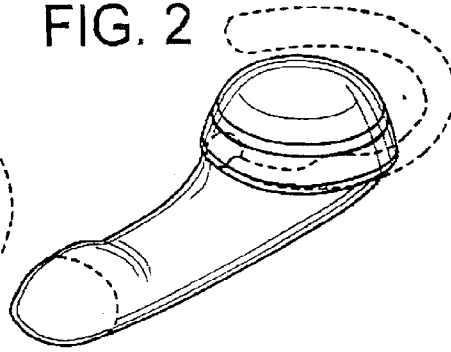

FIG. 3

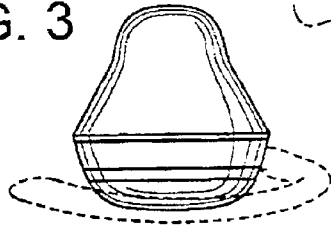

FIG. 5

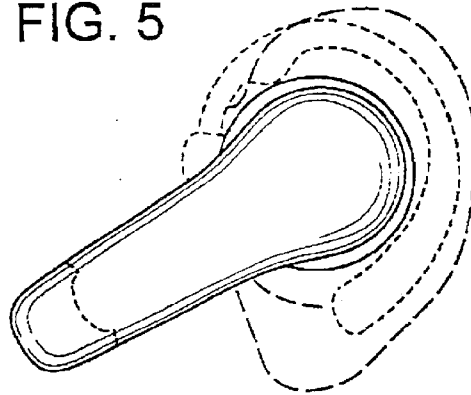

FIG. 4

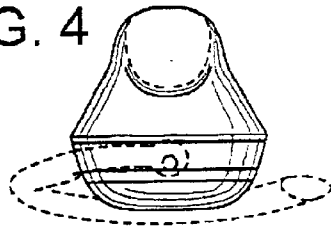

FIG. 6

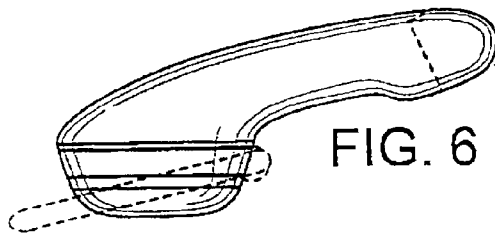

FIG. 8

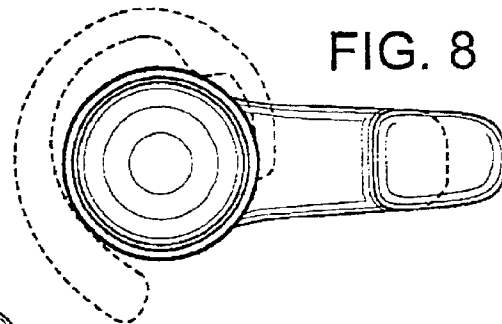

FIG. 7

