



US00D729575S

(12) **United States Design Patent**  
**Hu**

(10) **Patent No.:** **US D729,575 S**

(45) **Date of Patent:** **\*\* May 19, 2015**

(54) **IGNITER**

(71) Applicant: **Keren Hu**, Ningbo (CN)

(72) Inventor: **Keren Hu**, Ningbo (CN)

(\*\*) Term: **14 Years**

(21) Appl. No.: **29/458,235**

(22) Filed: **Jun. 17, 2013**

(51) **LOC (10) Cl.** ..... **07-99**

(52) **U.S. Cl.**

USPC ..... **D7/416**

(58) **Field of Classification Search**

CPC ..... F23Q 2/02; F23Q 2/167; F23Q 2/16;  
F23Q 1/06

USPC ..... D7/416, 417, 213; D9/423, 452, 454,  
D9/504, 563; D27/139, 141, 144, 147,  
D27/148, 152-157, 160, 183, 184; D8/30,  
D8/29.1; 206/236; 44/507; 361/260, 262;  
431/13, 144, 153, 255, 256, 266;  
126/409, 25 B, 401; 417/411

See application file for complete search history.

(56) **References Cited**

**U.S. PATENT DOCUMENTS**

D377,736	S	*	2/1997	Iwagaki et al.	.....	D7/416
5,738,507	A	*	4/1998	Mifune et al.	.....	431/344
D424,372	S	*	5/2000	Chevalier	.....	D7/416
D437,732	S	*	2/2001	Chevalier	.....	D7/416
D450,534	S	*	11/2001	Wang	.....	D7/416
D466,370	S	*	12/2002	Kim	.....	D7/416

D468,586	S	*	1/2003	Saito et al.	.....	D7/416
D482,932	S	*	12/2003	Sher	.....	D7/416
6,663,383	B2	*	12/2003	Jon	.....	431/153
D495,205	S	*	8/2004	Zhou	.....	D7/416
D510,841	S	*	10/2005	Hsu	.....	D7/416
D558,049	S	*	12/2007	Eaton et al.	.....	D9/522
D566,466	S	*	4/2008	Aronson et al.	.....	D7/416
7,556,494	B2	*	7/2009	Huang	.....	431/153
2006/0286496	A1	*	12/2006	Tu	.....	431/153

\* cited by examiner

*Primary Examiner* — Marianne Pandozzi

*Assistant Examiner* — Jae Liang

(74) *Attorney, Agent, or Firm* — Tianhua Gu; Global IP Services

(57) **CLAIM**

The ornamental design for an igniter, as shown and described.

**DESCRIPTION**

FIG. 1 is a front elevation of an igniter showing my new design;

FIG. 2 is a rear elevation view thereof;

FIG. 3 is a left side elevation view thereof;

FIG. 4 is an enlarged detail from the circled portion of FIG. 3;

FIG. 5 is a right side elevation view thereof;

FIG. 6 is a top plan view thereof;

FIG. 7 is a bottom plan view thereof;

FIG. 8 is a front perspective view thereof;

FIG. 9 is an enlarged detail from the circled portion of FIG. 8; and,

FIG. 10 is a rear perspective view thereof.

**1 Claim, 5 Drawing Sheets**

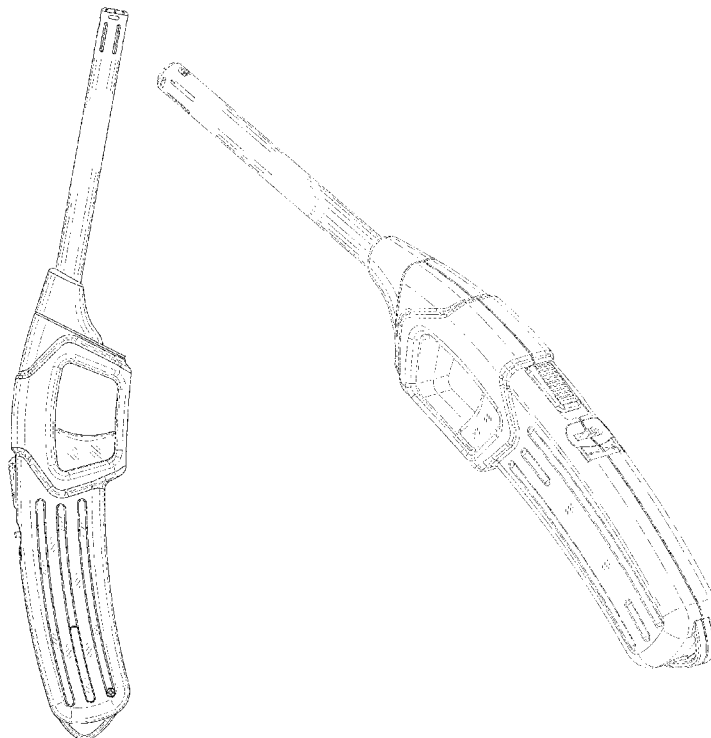

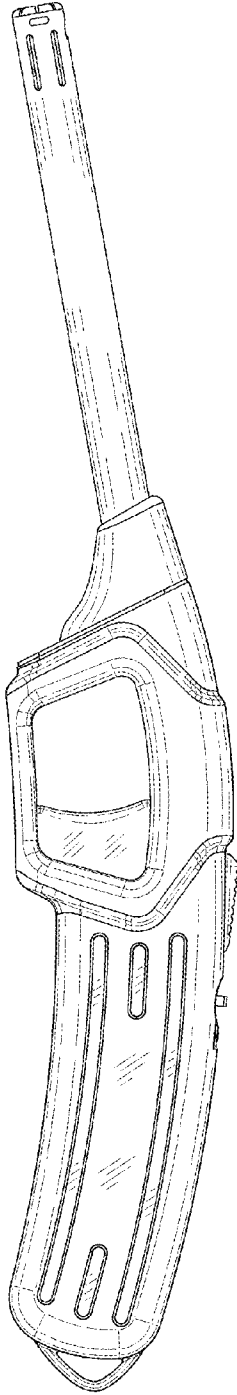

Fig. 1

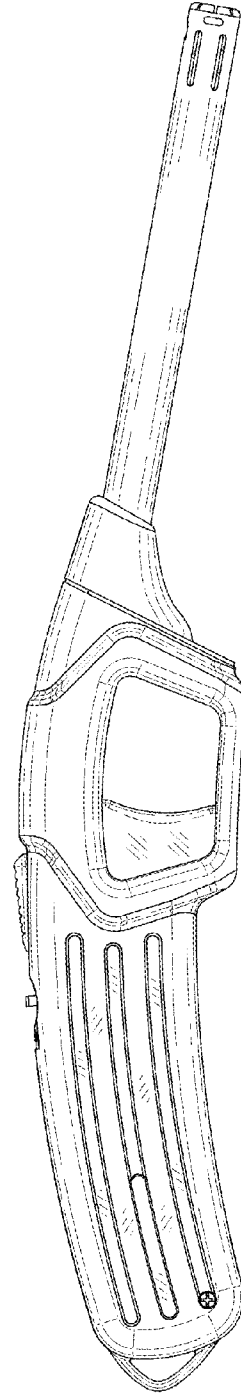

Fig. 2

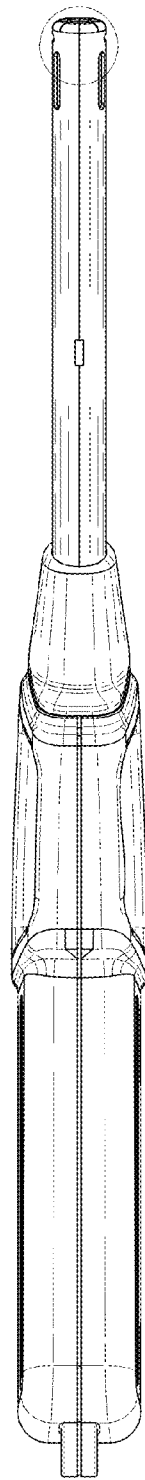

Fig. 3

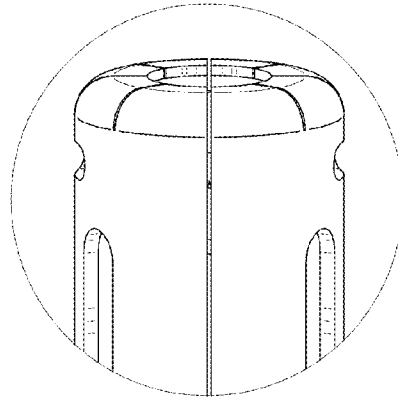

Fig. 4

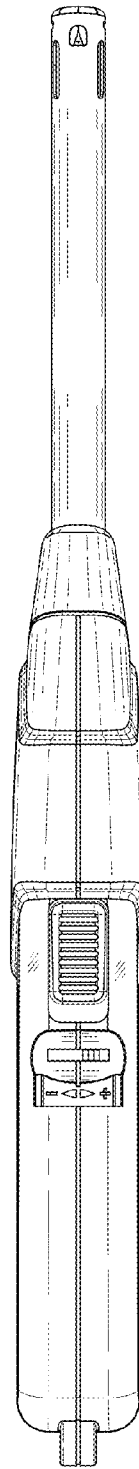

Fig. 5

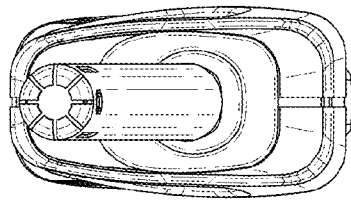

Fig. 6

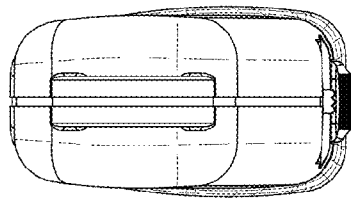

Fig. 7

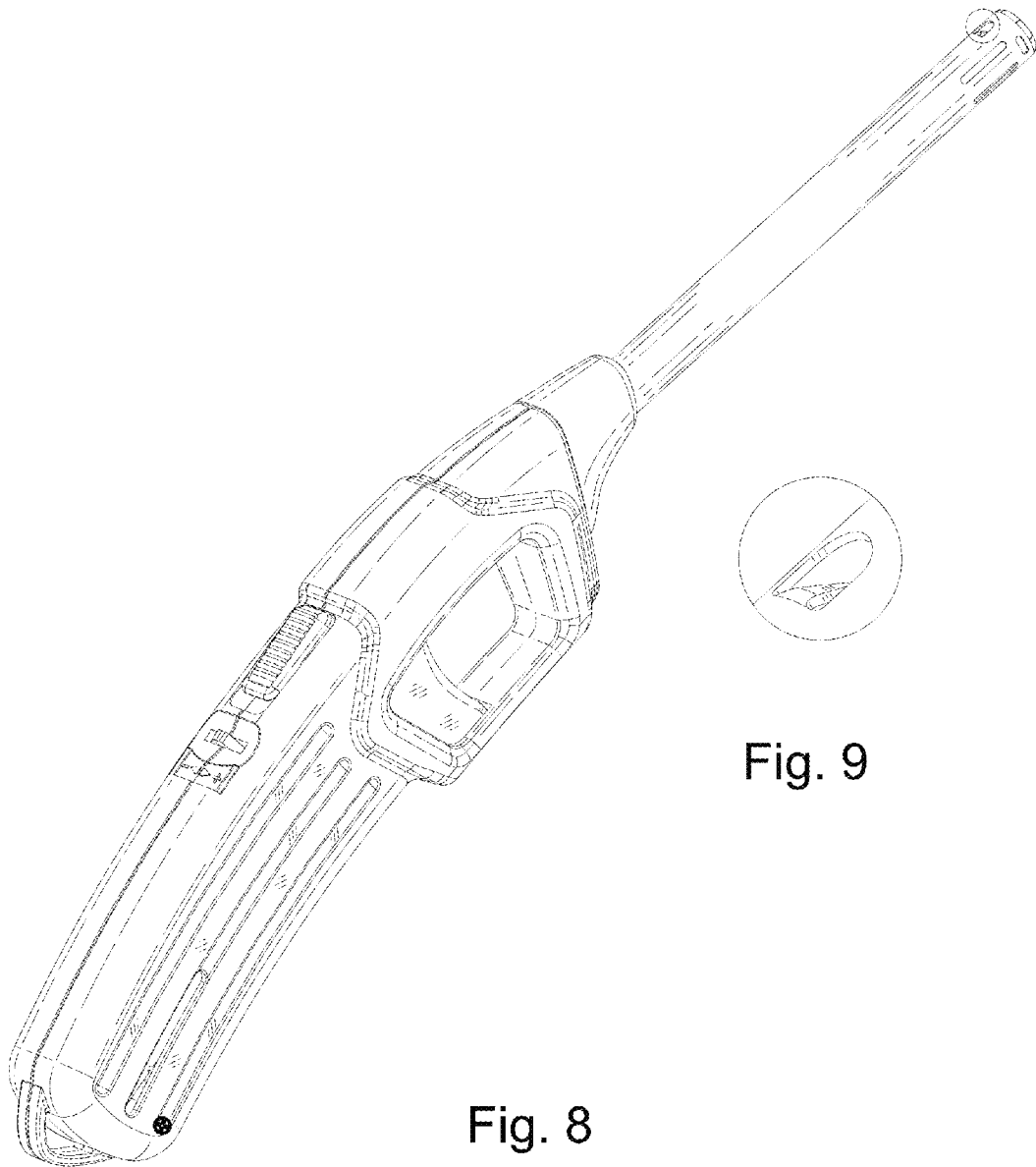

Fig. 8

Fig. 9

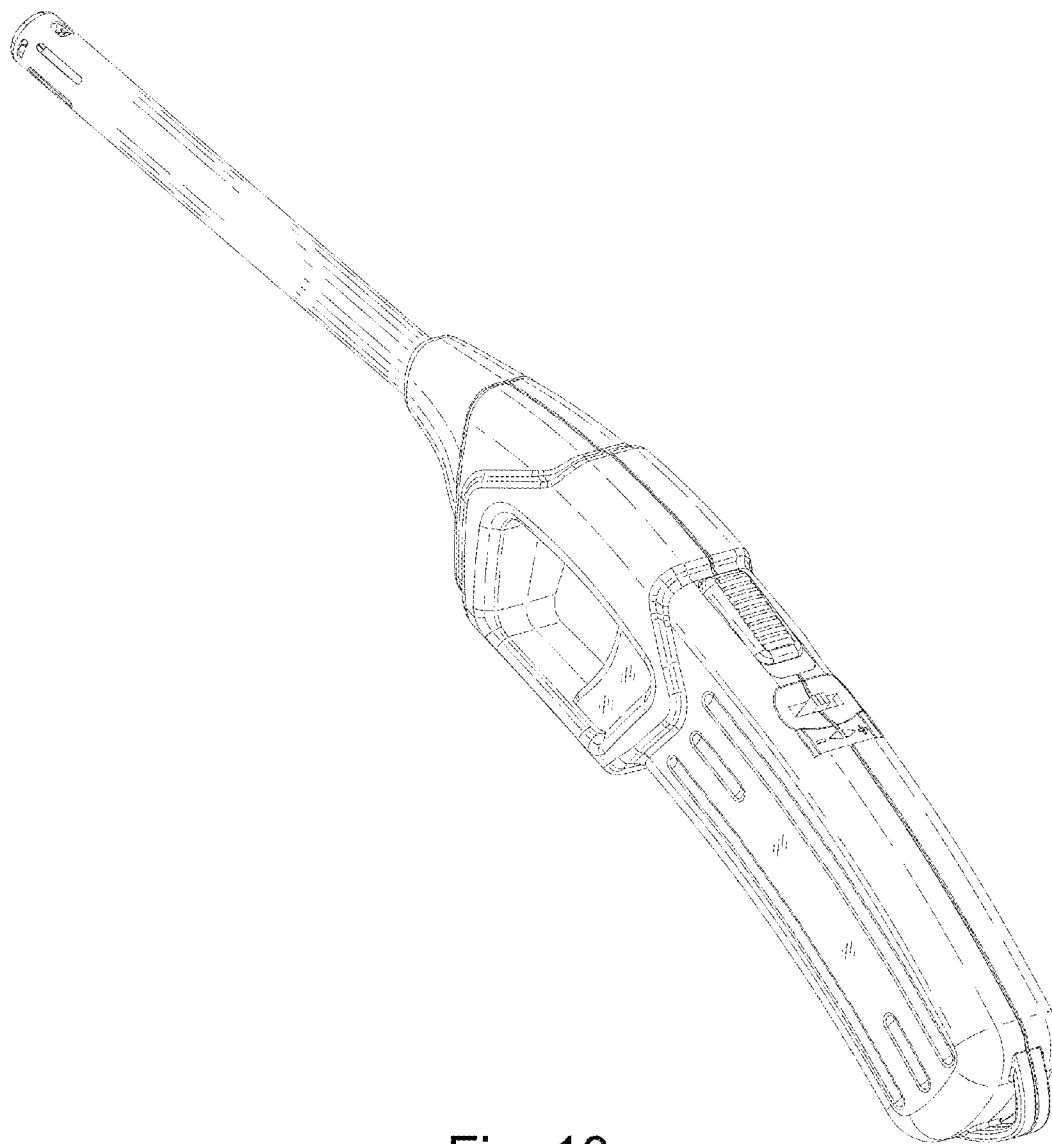

Fig. 10