



(12) **United States Design Patent**  
**Uppala et al.**

(10) **Patent No.:** **US D968,464 S**  
(45) **Date of Patent:** **\*\* Nov. 1, 2022**

- (54) **DISPLAY SCREEN OR PORTION THEREOF WITH ANIMATED GRAPHICAL USER INTERFACE**
- (71) Applicant: **Henny Penny Corporation**, Eaton, OH (US)
- (72) Inventors: **Roshni Uppala**, San Ramon, CA (US); **Joshua B. Murphy**, Shaker Heights, OH (US)
- (73) Assignee: **Henny Penny Corporation**, Eaton, OH (US)
- (\*\*) Term: **15 Years**
- (21) Appl. No.: **29/761,980**
- (22) Filed: **Dec. 14, 2020**

(56) **References Cited**

U.S. PATENT DOCUMENTS

- D570,366 S \* 6/2008 Sadler ..... D14/488
- D582,928 S \* 12/2008 Blankenship ..... D14/485
- 7,703,030 B2 \* 4/2010 Smirin ..... G06Q 30/02  
715/765
- D617,804 S \* 6/2010 Hirsch ..... D14/485
- D746,866 S \* 1/2016 Memoria ..... D14/492

(Continued)

*Primary Examiner* — Cary M Robinson

(74) *Attorney, Agent, or Firm* — Wood Herron & Evans LLP

(57) **CLAIM**

The ornamental design for a display screen or portion thereof with animated graphical user interface, as shown and described.

**DESCRIPTION**

FIG. 1 is a front view of a display screen or portion thereof with animated graphical user interface, showing a first image of a sequence; FIG. 2 is a front view of a second image thereof; FIG. 3 is a front view of a third image thereof; FIG. 4 is a front view of a fourth image thereof; FIG. 5 is a front view of a fifth image thereof; FIG. 6 is a front view of a sixth image thereof; FIG. 7 is a front view of a seventh image thereof; and, FIG. 8 is a front view of an eighth image thereof. FIGS. 1-8 depict a sequence of images for a display screen or portion thereof with animated graphical interface showing our new design. The appearance of the transitional image sequentially transitions between the images of the sequences shown in FIGS. 1-8. This process or period in which one image transitions to another forms no part of the claimed design. The broken lines in FIGS. 1-8 show the display screen or portion thereof and elements of the graphical user interface that are environmental aspects and form no part of the claimed design.

**Related U.S. Application Data**

- (62) Division of application No. 29/628,050, filed on Dec. 1, 2017, now Pat. No. Des. 907,649.
- (51) **LOC (13) Cl.** ..... **14-04**
- (52) **U.S. Cl.**  
USPC ..... **D14/492**
- (58) **Field of Classification Search**  
USPC ..... D14/485-495  
CPC ..... B60K 37/00; G06F 8/20; G06F 3/048-04897; G06F 3/013; G06F 3/017; G06F 3/165; G06F 16/168; G06F 16/7335; G06F 2203/014; G06F 2206/1008; G06F 2209/545; G06F 30/12; G06F 40/106; G06T 13/80; G06T 15/00; G06T 15/02; G06Q 10/10; H04M 1/6075; H04M 3/567; H04M 1/2477; H04M 1/26; H04L 51/04; H04L 12/1813; H04N 7/16; H04N 1/00408

See application file for complete search history.

**1 Claim, 8 Drawing Sheets**

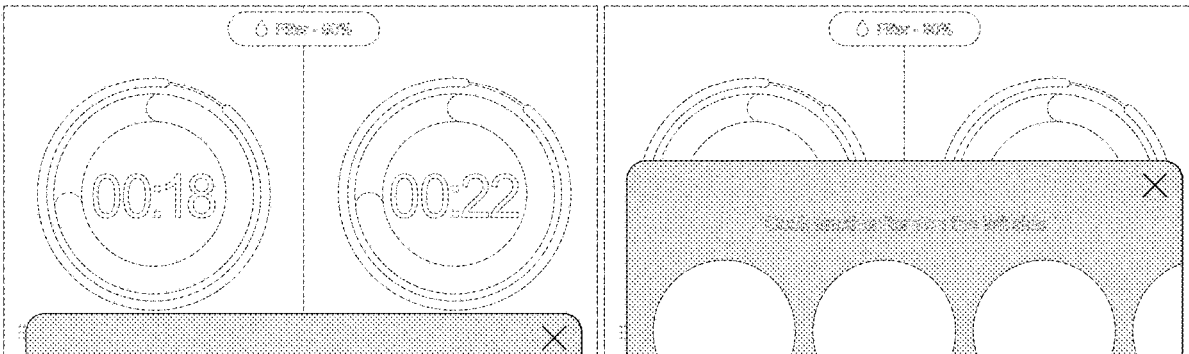

(56)

## References Cited

## U.S. PATENT DOCUMENTS

D759,061 S \* 6/2016 Sahoo ..... D14/485  
D762,671 S \* 8/2016 Chan ..... D14/488  
D765,711 S \* 9/2016 Henderson ..... D14/486  
D766,315 S 9/2016 Choi et al.  
D769,930 S 10/2016 Agrawal  
D780,798 S \* 3/2017 Yang ..... D14/487  
D787,533 S 5/2017 Butcher et al.  
D821,434 S \* 6/2018 Park ..... D14/486  
D822,693 S 7/2018 Javor et al.  
D836,669 S 12/2018 Manickavasagam et al.  
D837,262 S \* 1/2019 Lee ..... D14/492  
D848,480 S \* 5/2019 Lee ..... D14/492  
D848,481 S \* 5/2019 Lee ..... D14/492  
D851,099 S 6/2019 Uppala et al.  
D853,430 S 7/2019 Amini et al.  
D864,992 S 10/2019 Uppala et al.  
D877,198 S \* 3/2020 Lee ..... D14/492  
D880,495 S \* 4/2020 Dascola ..... D14/485  
D888,757 S 6/2020 Fan  
D888,764 S \* 6/2020 Lee ..... D14/492  
D895,657 S 9/2020 Howland et al.  
D898,763 S 10/2020 Felkins et al.  
D924,889 S \* 7/2021 Gromek ..... D14/485  
11,150,782 B1 \* 10/2021 Underwood ..... G06Q 50/01  
11,188,215 B1 \* 11/2021 Holland ..... H04L 67/306  
D958,155 S \* 7/2022 Dunnette ..... D14/485  
D960,187 S \* 8/2022 Tran ..... D14/492  
2015/0106726 A1 4/2015 Nagasaki et al.  
2017/0109178 A1 \* 4/2017 Chen ..... G06Q 20/322  
2017/0185991 A1 \* 6/2017 Park ..... G06Q 20/351

\* cited by examiner

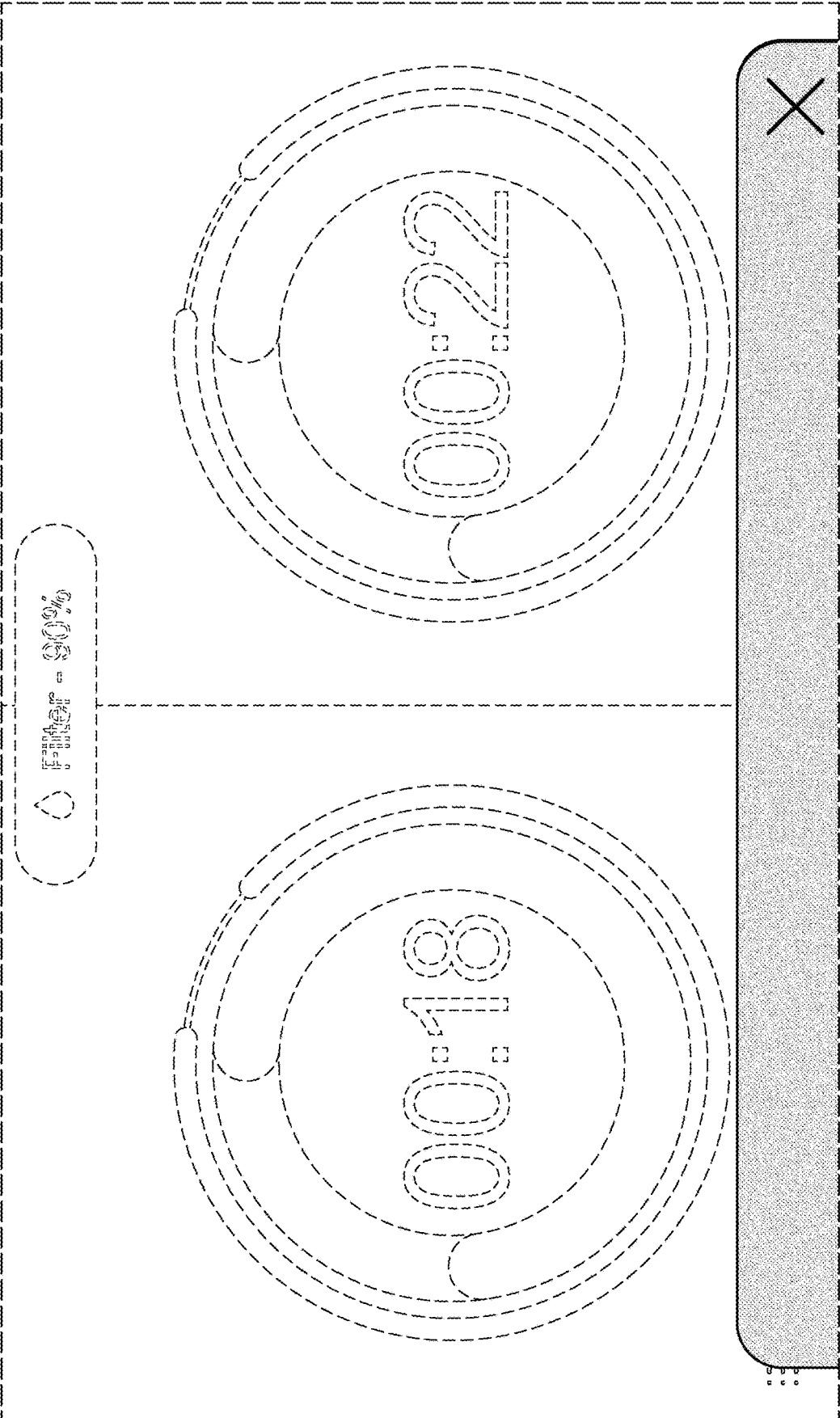

FIG. 1

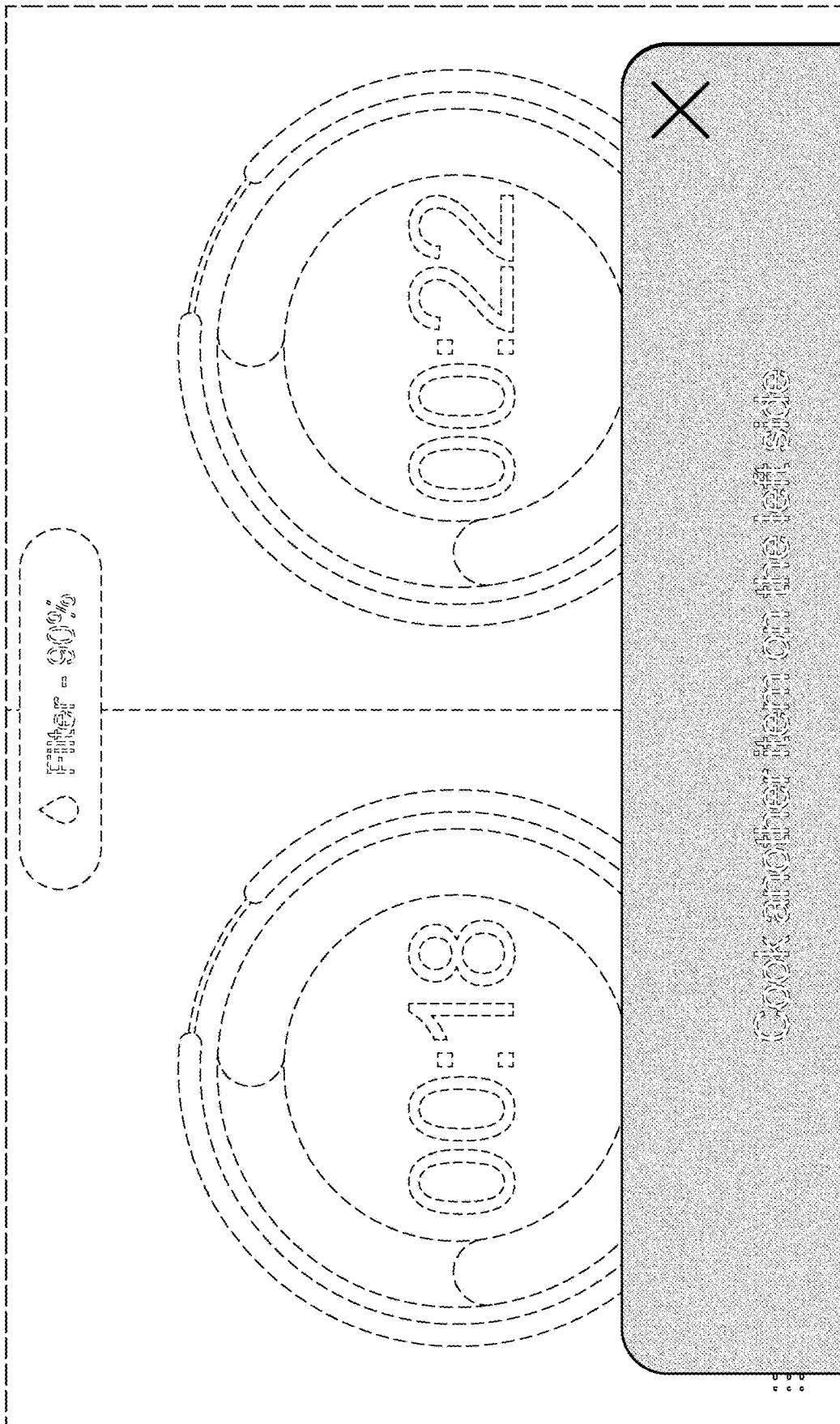

FIG. 2

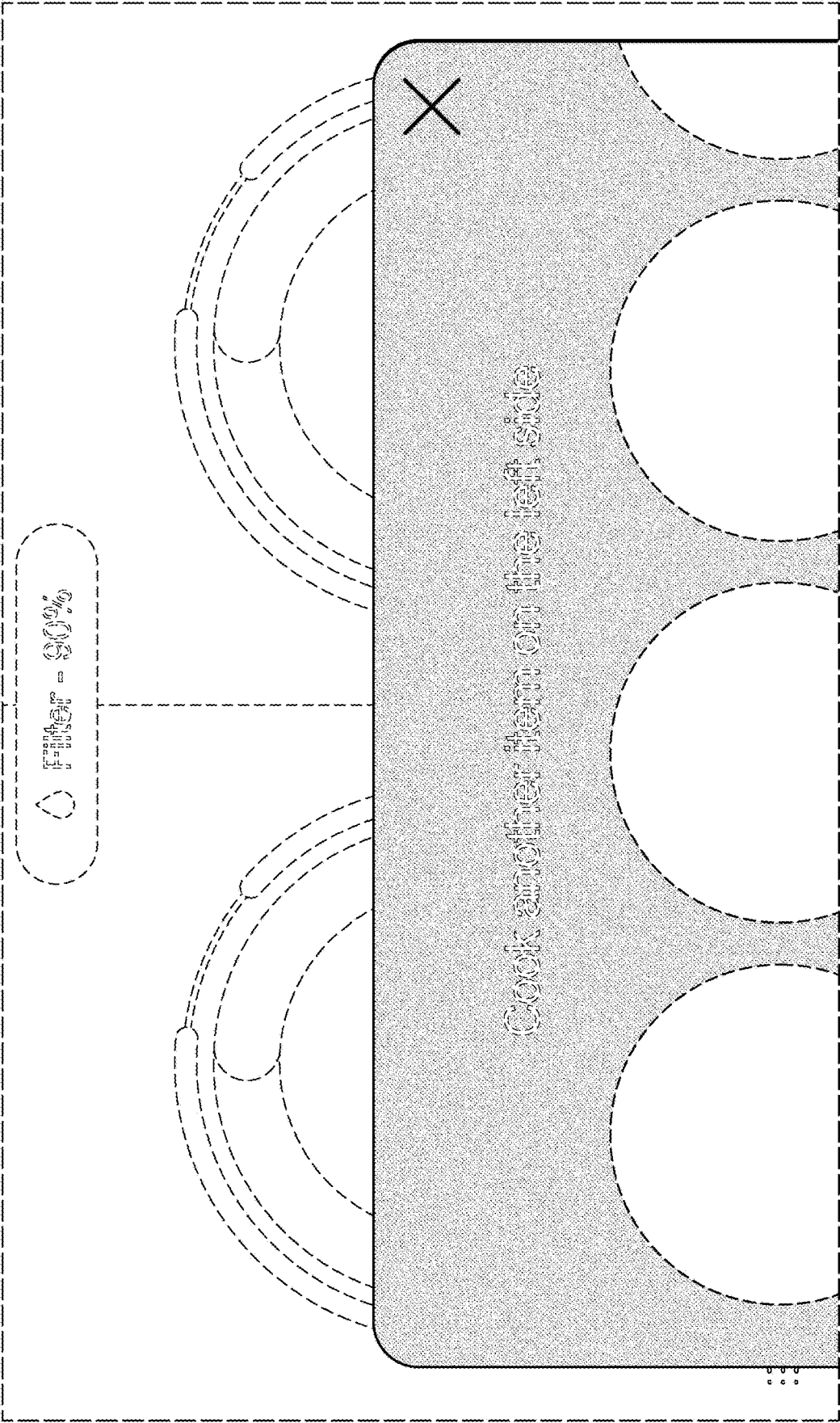

FIG. 3

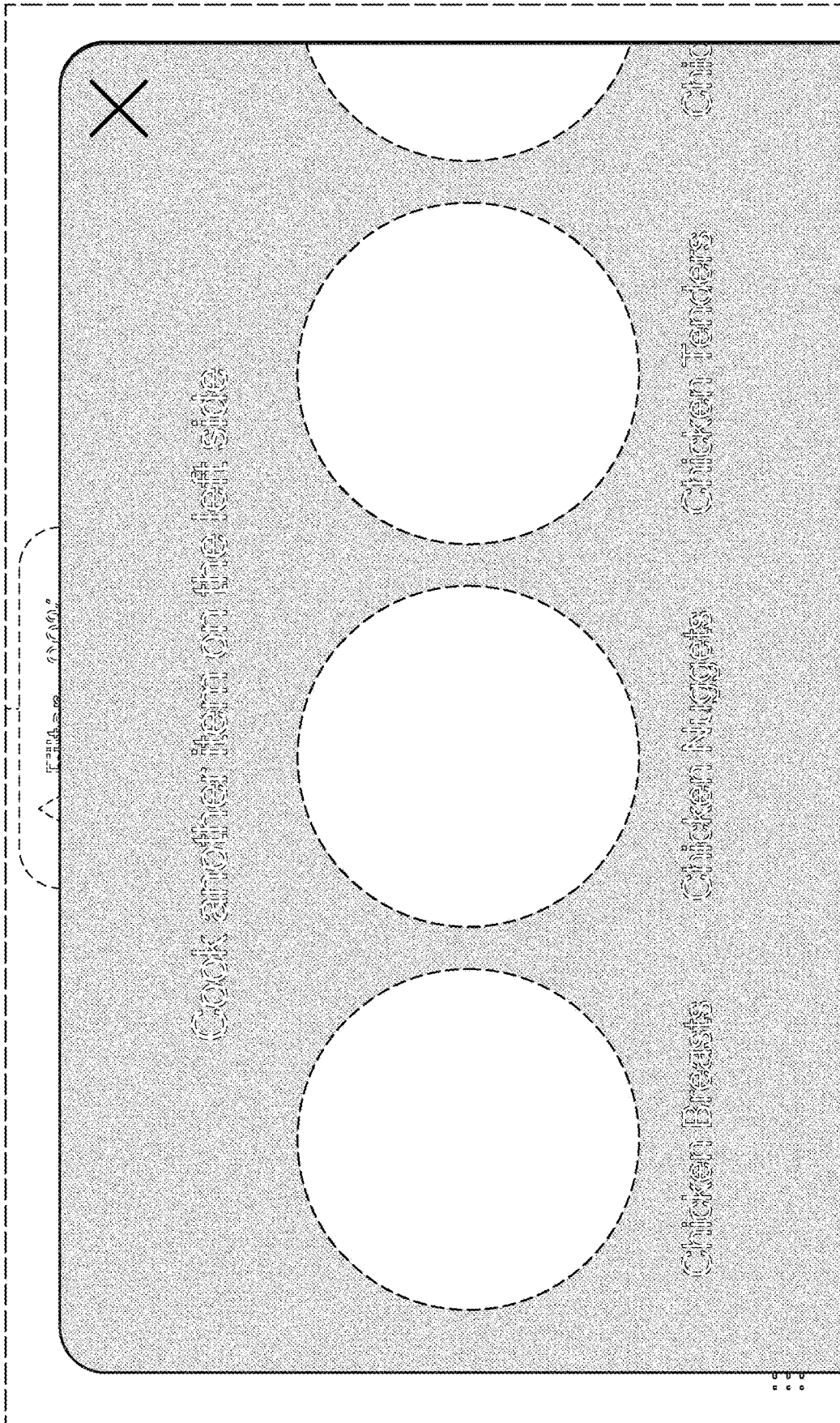

FIG. 4

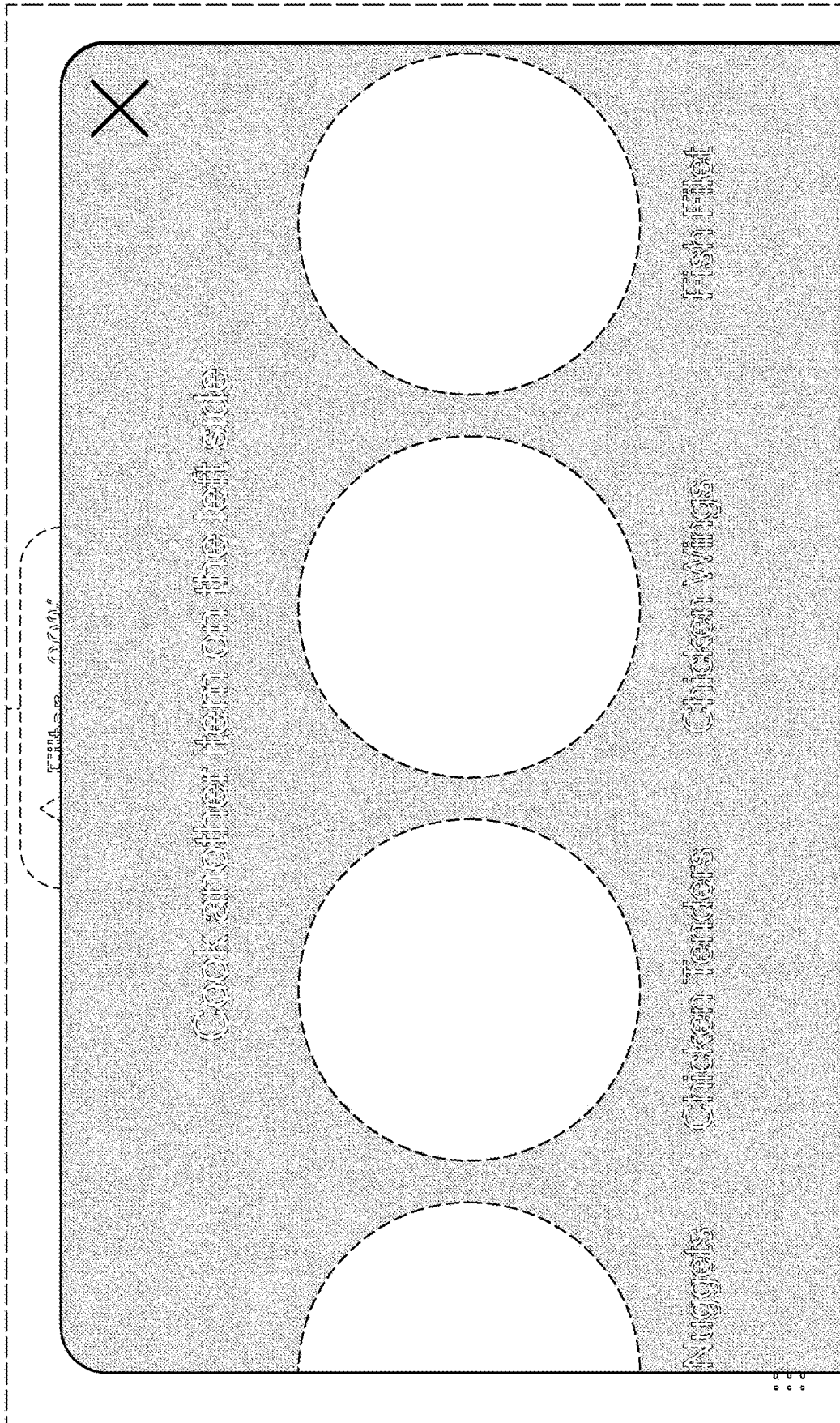

FIG. 5

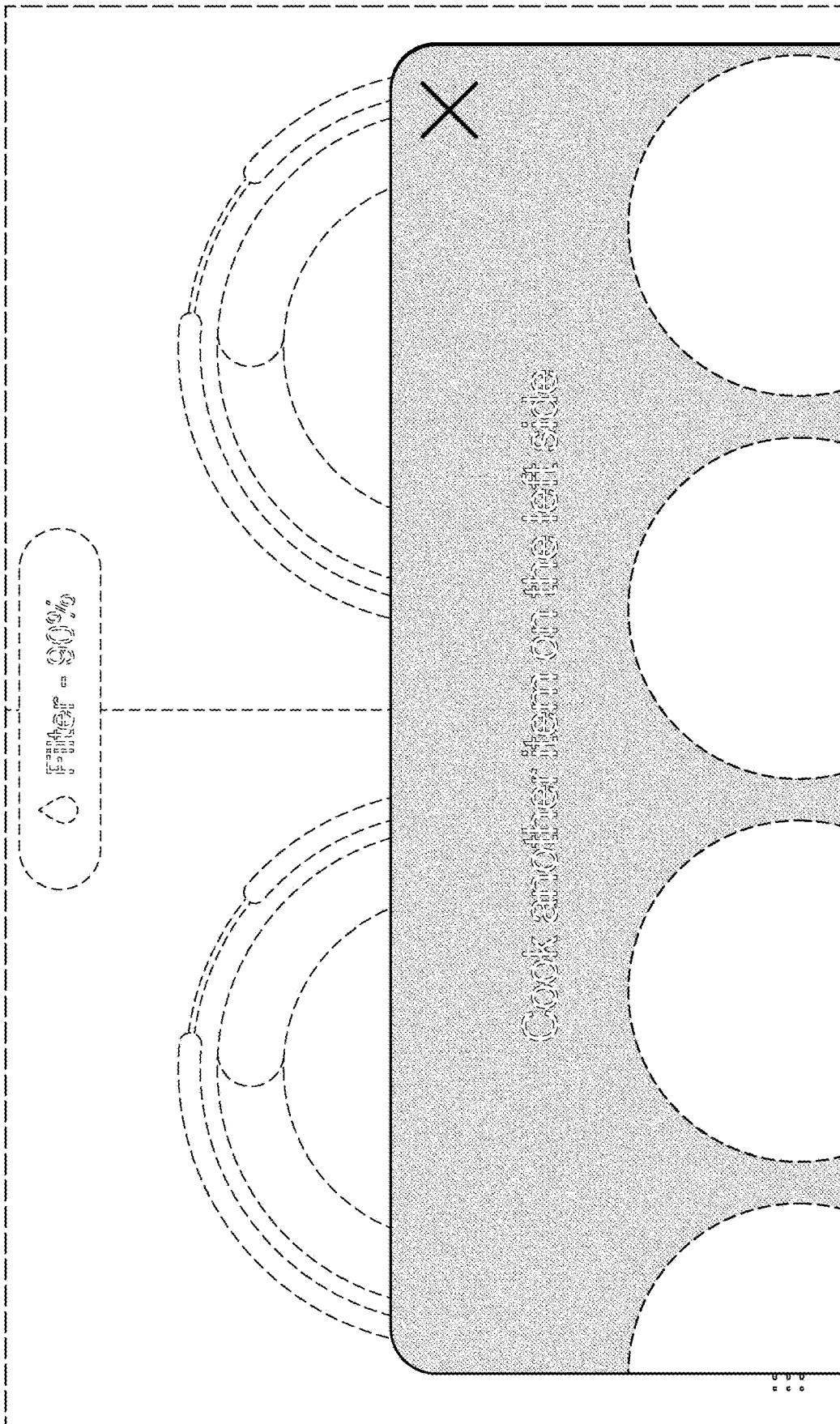

FIG. 6

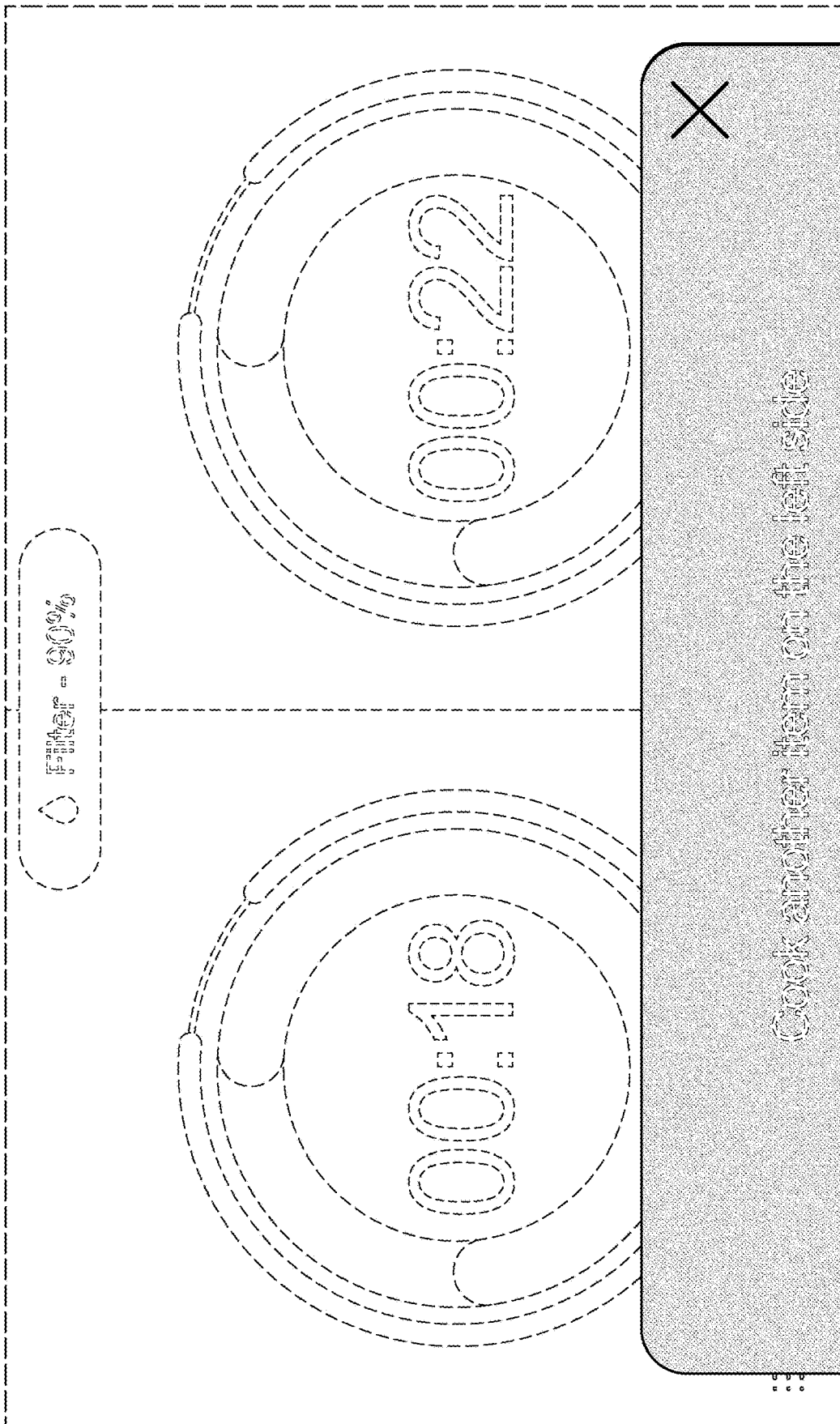

FIG. 7

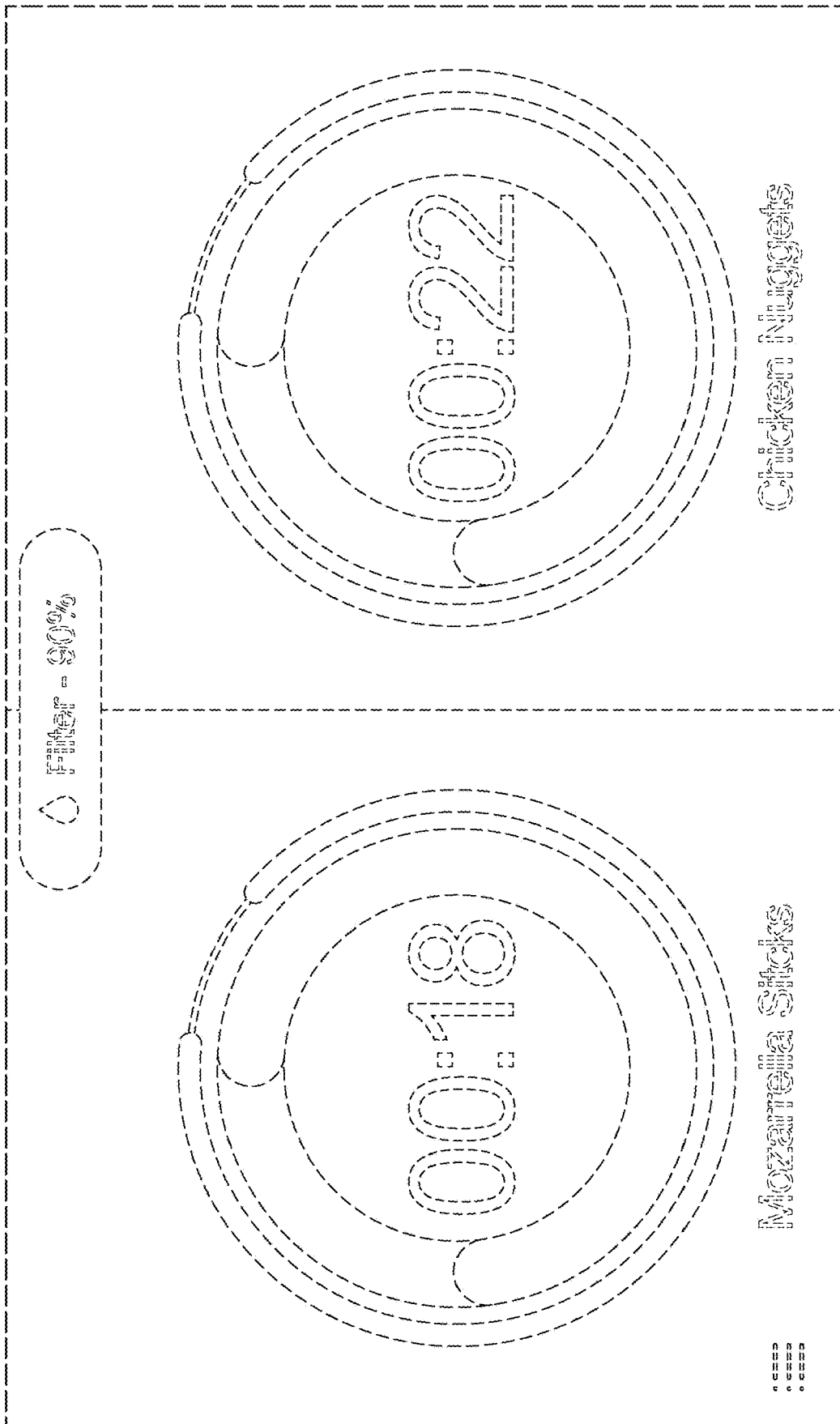

FIG. 8