



US00D704698S

(12) **United States Design Patent**
Morikawa

(10) **Patent No.:** **US D704,698 S**

(45) **Date of Patent:** **** May 13, 2014**

(54) **DIGITAL AUDIO DISC PLAYER FOR
AUTOMOBILE**

(71) Applicant: **JVC Kenwood Corporation**, Kanagawa
(JP)

(72) Inventor: **Rika Morikawa**, Kanagawa (JP)

(73) Assignee: **JVC Kenwood Corporation**, Kanagawa
(JP)

(**) Term: **14 Years**

(21) Appl. No.: **29/470,093**

(22) Filed: **Oct. 17, 2013**

(30) **Foreign Application Priority Data**

May 22, 2013 (JP) 2013-011201

(51) **LOC (10) Cl.** **14-03**

(52) **U.S. Cl.**

USPC **D14/258**

(58) **Field of Classification Search**

USPC D12/82, 192, 195, 415; D14/131, 132,
D14/137, 155, 157, 167-172, 188, 197, 198,
D14/239, 257, 258, 345-355, 400, 496,
D14/498-505, 511; D16/202, 206;
D21/329-332, 669, 670, 696;
360/99.02, 99.07; 369/6-12, 75.11,
369/75.21, 77.11; 455/344, 348-355,
455/575.9; 720/612, 619, 649, 655

See application file for complete search history.

(56) **References Cited**

U.S. PATENT DOCUMENTS

D400,529	S	*	11/1998	Kakizaki	D14/157
D483,731	S	*	12/2003	Yoshihara	D14/157
D483,732	S	*	12/2003	Yoshihara	D14/157
D496,930	S	*	10/2004	Yoshihara	D14/258
D605,660	S	*	12/2009	Yagihashi	D14/505
D672,331	S	*	12/2012	Kanou	D14/157
D680,094	S	*	4/2013	Kanou	D14/157

* cited by examiner

Primary Examiner — Prabhakar Deshmukh

Assistant Examiner — Janice Lim

(74) *Attorney, Agent, or Firm* — Osha Liang LLP

(57) **CLAIM**

The ornamental design for digital audio disc player for automobile, as shown and described.

DESCRIPTION

FIG. 1 is a perspective view of front, right and top of digital audio disc player for automobile showing my new design; FIG. 2 is a front view thereof; FIG. 3 is a rear view thereof; FIG. 4 is a left side view thereof; FIG. 5 is a right side view thereof; FIG. 6 is a top view thereof; and, FIG. 7 is a bottom view thereof.

The broken lines shown are included for the purpose of illustrating the unclaimed portions of digital audio disc player for automobile and form no part of the claimed design.

1 Claim, 5 Drawing Sheets

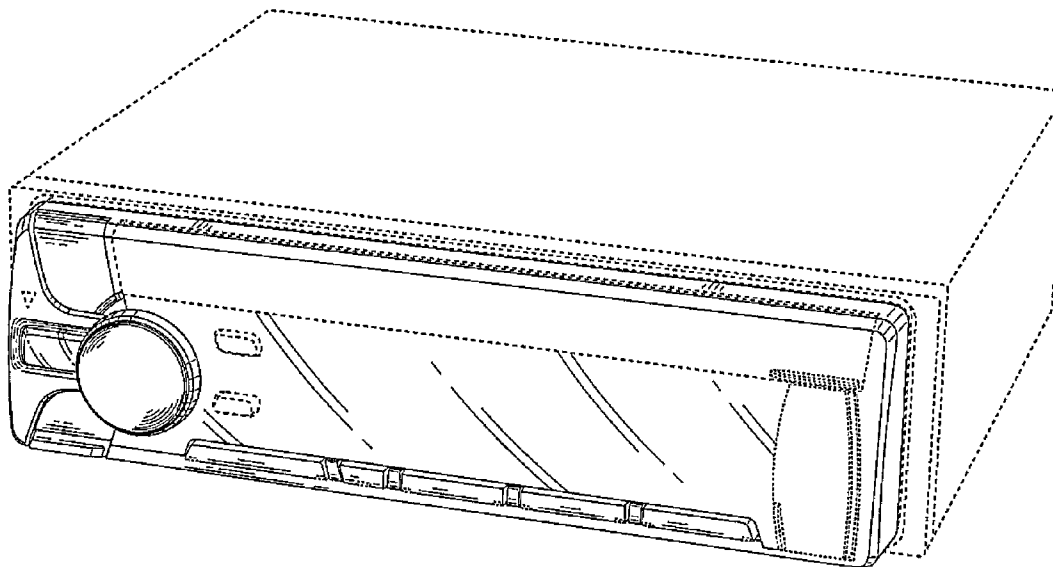

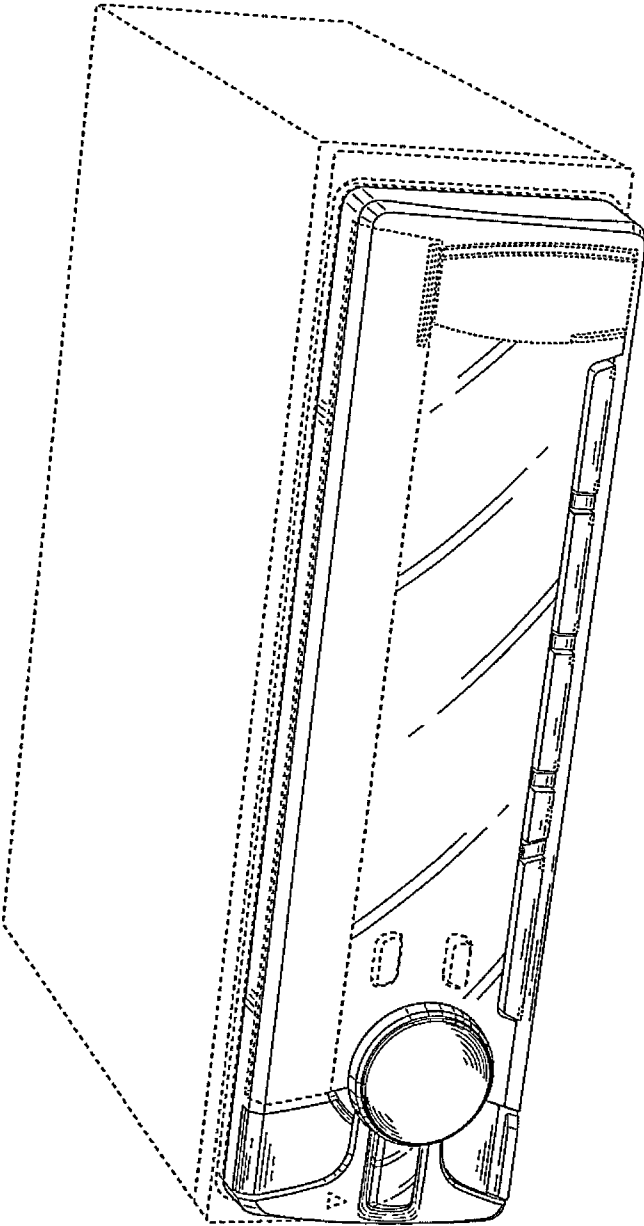

FIG. 1

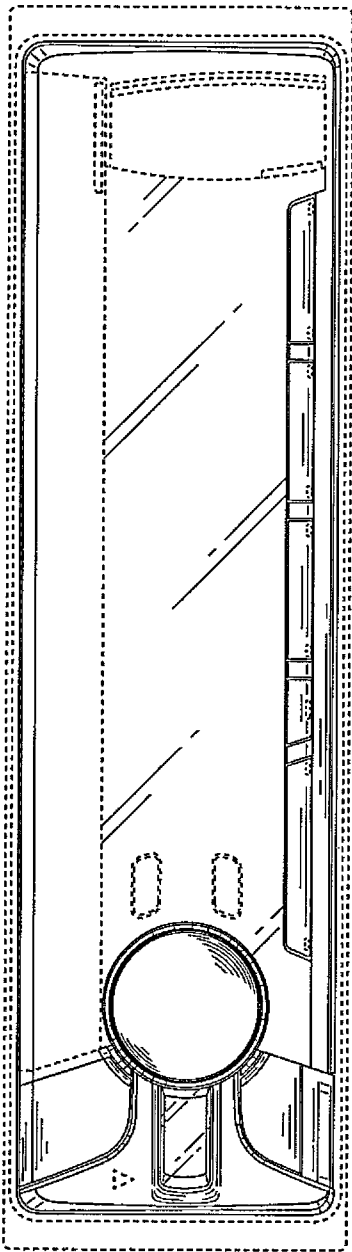

FIG. 2

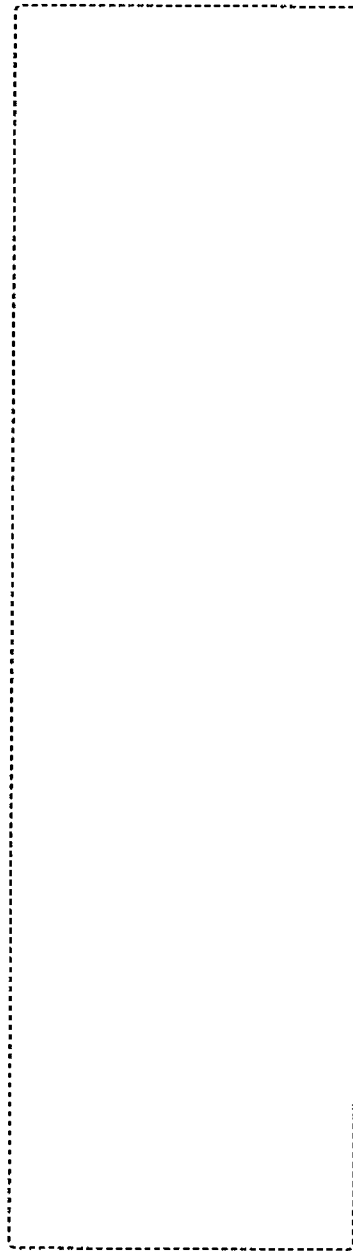

FIG. 3

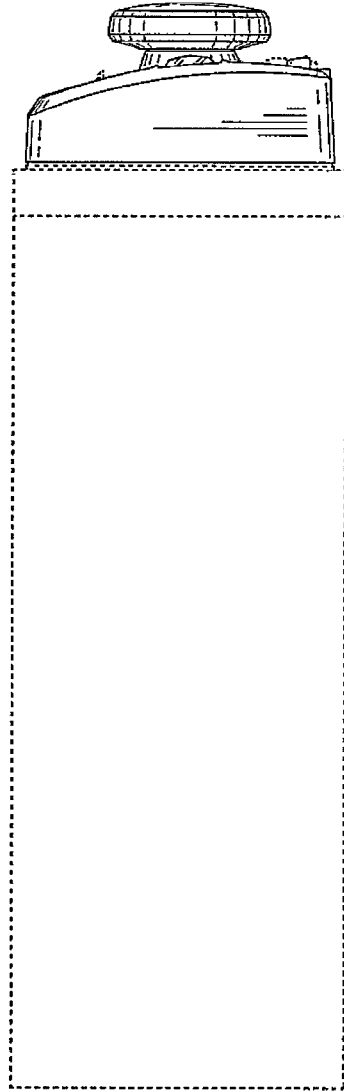

FIG. 4

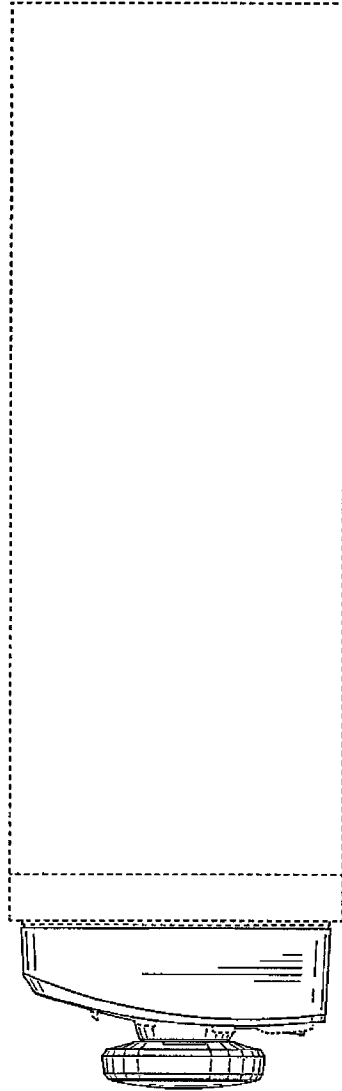

FIG. 5

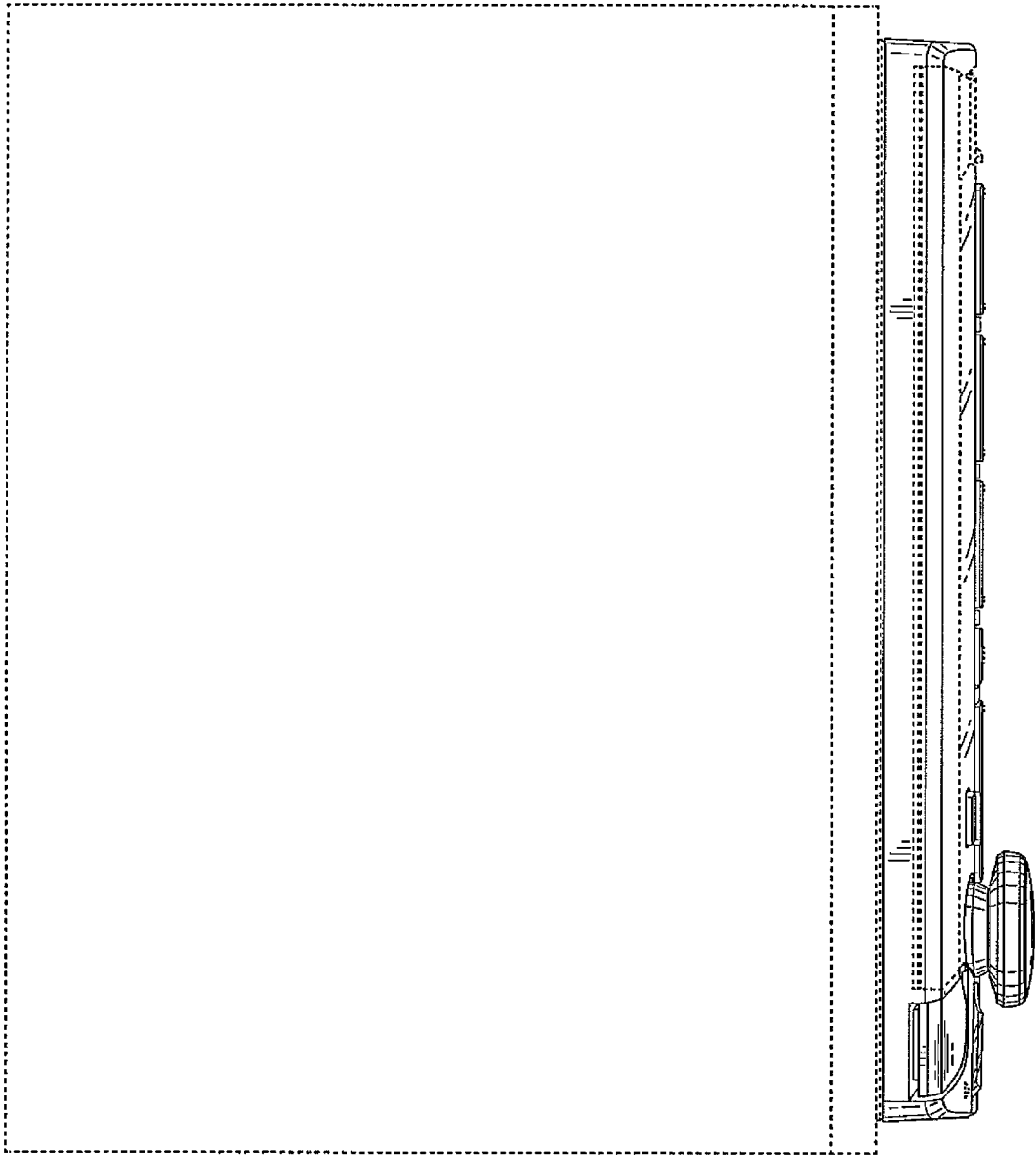

FIG. 6

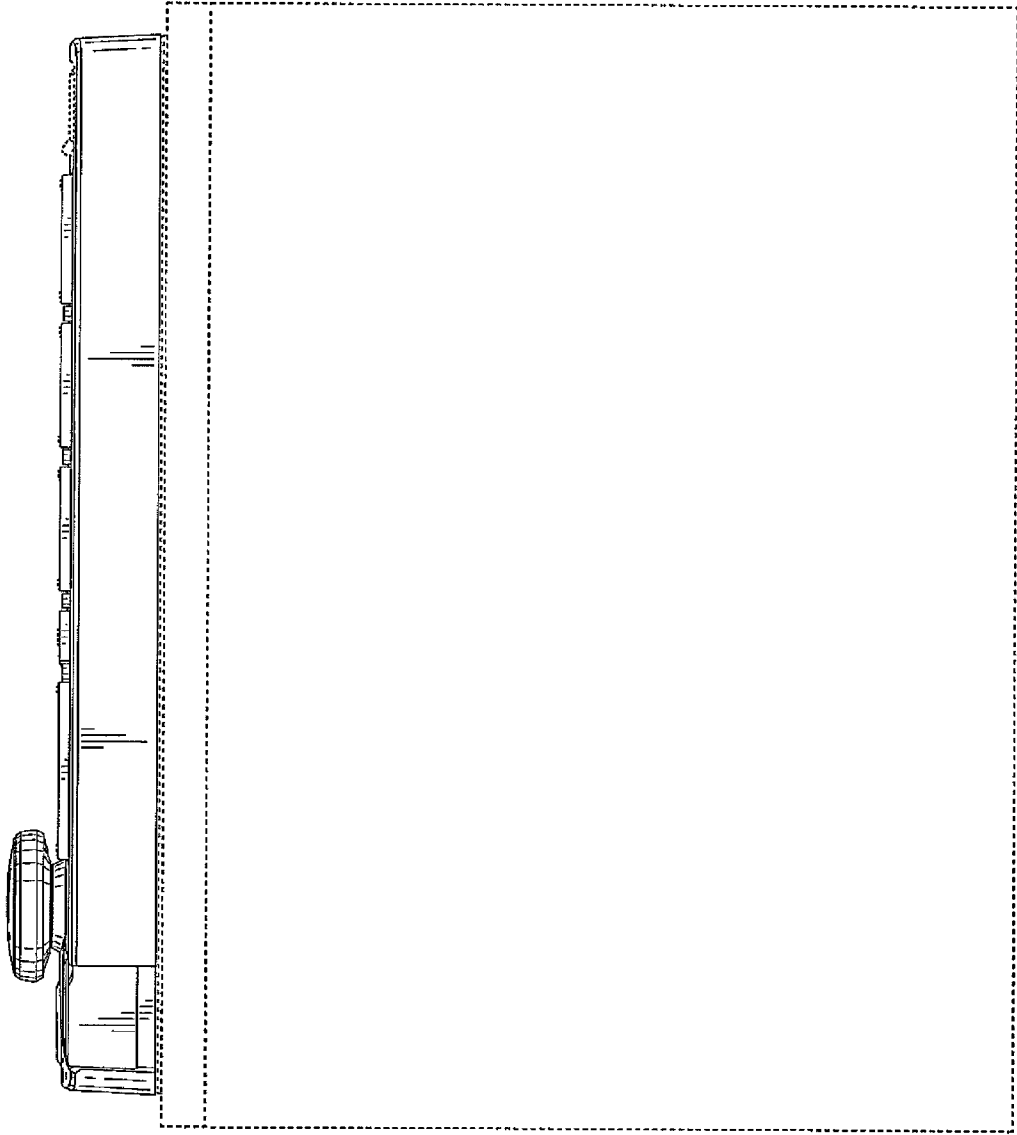

FIG. 7