



US0D1069079S

(12) **United States Design Patent**
Qu et al.

(10) **Patent No.:** **US D1,069,079 S**

(45) **Date of Patent:** **** Apr. 1, 2025**

(54) **COLUMN DIFFUSER**

(71) Applicant: **Guangdong 3004 Technology Co., Ltd.**, Guangzhou (CN)

(72) Inventors: **Xingang Qu**, Guangzhou (CN); **Jiabiao Xie**, Guangzhou (CN); **Kunxi Xie**, Guangzhou (CN)

(73) Assignee: **Guangdong 3004 Technology Co., Ltd.**, Guangzhou (CN)

(**) Term: **15 Years**

(21) Appl. No.: **29/912,649**

(22) Filed: **Sep. 21, 2023**

(30) **Foreign Application Priority Data**

May 17, 2023 (CN) 202330288903.4

(51) **LOC (15) Cl.** **23-04**

(52) **U.S. Cl.**
USPC **D23/366**

(58) **Field of Classification Search**

USPC D14/155, 188, 203.2, 204, 209.1, 210,
D14/211, 213, 214, 215, 216, 228, 348,
(Continued)

(56) **References Cited**

U.S. PATENT DOCUMENTS

D267,970 S * 2/1983 Gronwick D23/336
D296,665 S * 7/1988 Hofer D11/146
(Continued)

Primary Examiner — Gino Colan

Assistant Examiner — David OBrien

(74) *Attorney, Agent, or Firm* — Westbridge IP LLC

(57) **CLAIM**

The ornamental design for a column diffuser, as shown and described.

DESCRIPTION

FIG. 1 is a top perspective view of a column diffuser according to a first embodiment showing our new design; FIG. 2 is a bottom perspective view thereof; FIG. 3 is a front elevational view thereof; FIG. 4 is a rear elevational view thereof; FIG. 5 is a left side elevational view thereof; FIG. 6 is a right side elevational view thereof; FIG. 7 is a top plan view thereof; FIG. 8 is a bottom plan view thereof; FIG. 9 is an enlarged view of the portion indicated by line 9 in FIG. 1;

FIG. 10 is a top perspective view of a column diffuser according to a second embodiment; FIG. 11 is a bottom perspective view of FIG. 10; FIG. 12 is a front elevational view of FIG. 10; FIG. 13 is a rear elevational view of FIG. 10; FIG. 14 is a left side elevational view of FIG. 10; FIG. 15 is a right side elevational view of FIG. 10; FIG. 16 is a top plan view of FIG. 10; FIG. 17 is a bottom plan view of FIG. 10; FIG. 18 is an enlarged view of the portion indicated by line 18 in FIG. 10;

FIG. 19 is a top perspective view of a column diffuser according to a third embodiment; FIG. 20 is a bottom perspective view of FIG. 19; FIG. 21 is a front elevational view of FIG. 19; FIG. 22 is a rear elevational view of FIG. 19; FIG. 23 is a left side elevational view of FIG. 19; FIG. 24 is a right side elevational view of FIG. 19; FIG. 25 is a top plan view of FIG. 19; FIG. 26 is a bottom plan view of FIG. 19; and, FIG. 27 is an enlarged view of the portion indicated by line 27 in FIG. 19.

The dash-dash broken lines in the drawings illustrate the portions of the column diffuser which form no part of the claimed design.

The dot-dash broken lines in the drawings are included for the purpose of illustrating the partial enlarged views.

1 Claim, 27 Drawing Sheets

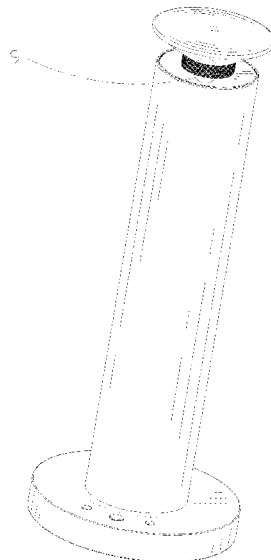

(58) **Field of Classification Search**

USPC D14/358, 371; D23/207-210, 269, 324,
 D23/325, 332-337, 341, 342, 351-370,
 D23/378; D26/26, 49, 51, 110;
 D28/91.1; D12/415, 420; D11/81, 131.1,
 D11/143-154; D7/509, 532, 602, 608,
 D7/705, 619.1, 622, 624.1, 630; D9/424,
 D9/432, 504, 556, 772, 780; D13/108;
 D21/655; D24/215; D15/199
 CPC ... A61L 9/00; A61L 9/03; A61L 9/032; A61L
 9/035; A61L 9/037; A61L 9/04; A61L
 9/05; A61L 9/12; A61L 9/14; A61L 9/20;
 A61L 9/22; A61L 9/012; A61L 9/015;
 A61L 9/048; A61L 9/122; A61L 9/127;
 A61L 9/205; A61L 2209/11; A61L
 2209/14; A61L 2209/133; A61L
 2209/134; F24F 1/02; F24F 1/0007; F24F
 1/0067; F24F 1/0071; F24F 1/008; F24F
 1/0083; F24F 1/0087; F24F 1/0328; F24F
 1/0355; F24F 1/0358; F24F 5/00; F24F
 6/00; F24F 6/02; F24F 6/12; F24F 7/003;
 F24F 8/00; F24F 8/10; F24F 8/20; F24F
 8/30; F24F 8/40; F24F 8/50; F24F 8/183;
 F24F 13/082; F24F 13/084; F24F 13/085;
 Y10S 261/03; Y10S 261/04; Y10S
 261/17; Y10S 261/31; Y10S 261/42;
 Y10S 261/43; Y10S 261/65; Y10S
 261/88; Y10S 261/89; A61G 17/00;

A61G 17/08; A47G 23/03; A47G
 23/0216; A47G 2019/2277; A47G 19/22;
 A47G 19/2205; A47G 19/2211; A47G
 19/2288; B31F 1/0038; B01D 46/00;
 B01D 46/10; B01D 46/001; B01D
 46/0002; B01D 46/0004; B01D 46/0005;
 B01D 46/0012; B01D 46/0015; B01D
 46/0016; B01D 46/02; B01D 46/24;
 B01D 46/2411; B01D 46/2486; B01D
 46/2488; B01D 46/249; B01D 46/2492;
 B01D 46/58; B01D 46/527; B01D
 53/0431; B65D 85/8061; B65D 83/30

See application file for complete search history.

(56)

References Cited

U.S. PATENT DOCUMENTS

6,379,433	B1 *	4/2002	Scranton, Jr.	B01D 53/0431 55/412
D537,073	S *	2/2007	Peersman	D14/216
D783,794	S *	4/2017	Shen	D23/364
D832,414	S *	10/2018	Sharma	D23/364
D851,230	S *	6/2019	Li	D23/366
D864,374	S *	10/2019	Lee	D23/366
D914,189	S *	3/2021	Ye	D23/366
D942,409	S *	2/2022	Hsu	D14/204
D952,819	S *	5/2022	Yang	D23/364
D1,018,504	S *	3/2024	Ma	D14/216
2019/0111171	A1 *	4/2019	Park	A61L 9/12

* cited by examiner

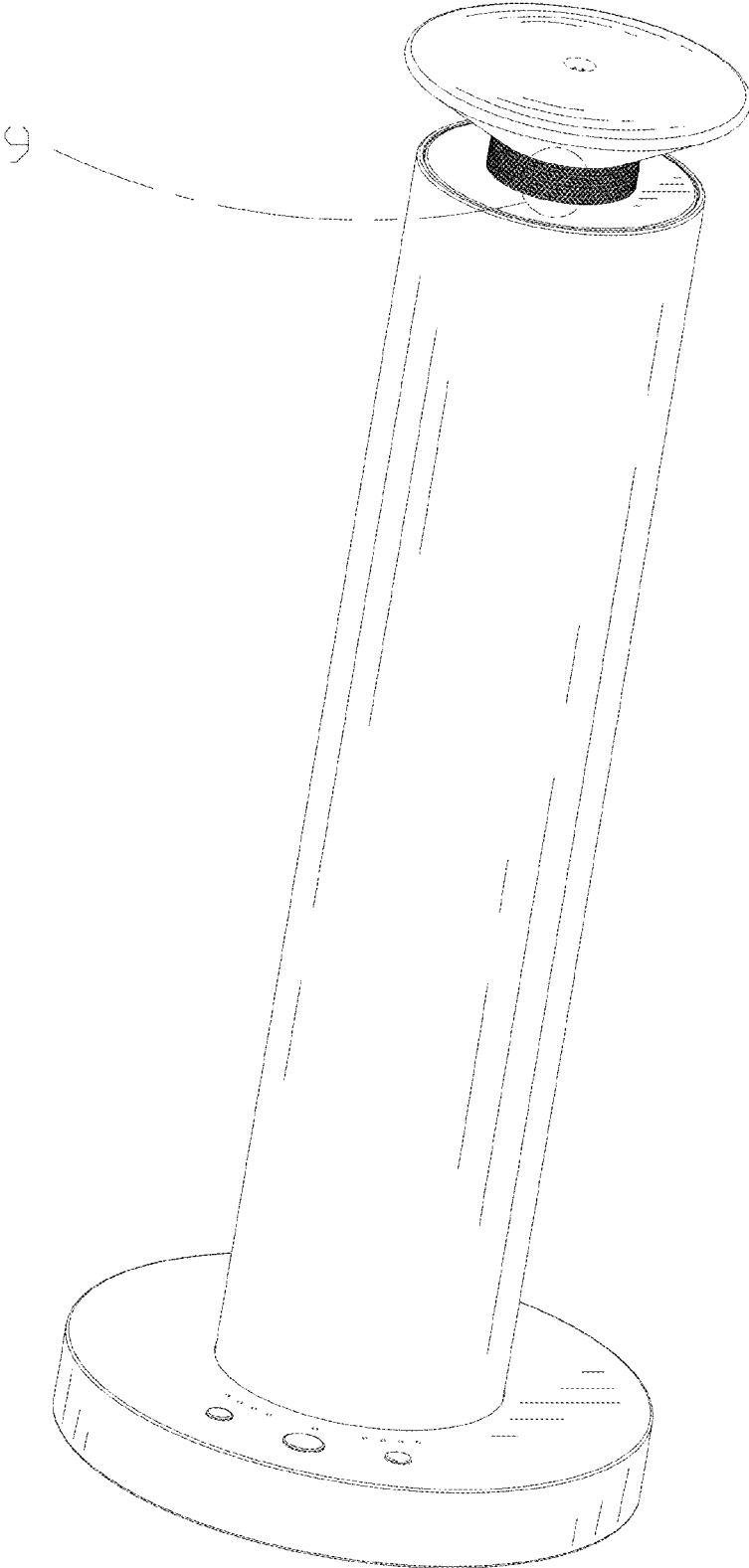

FIG. 1

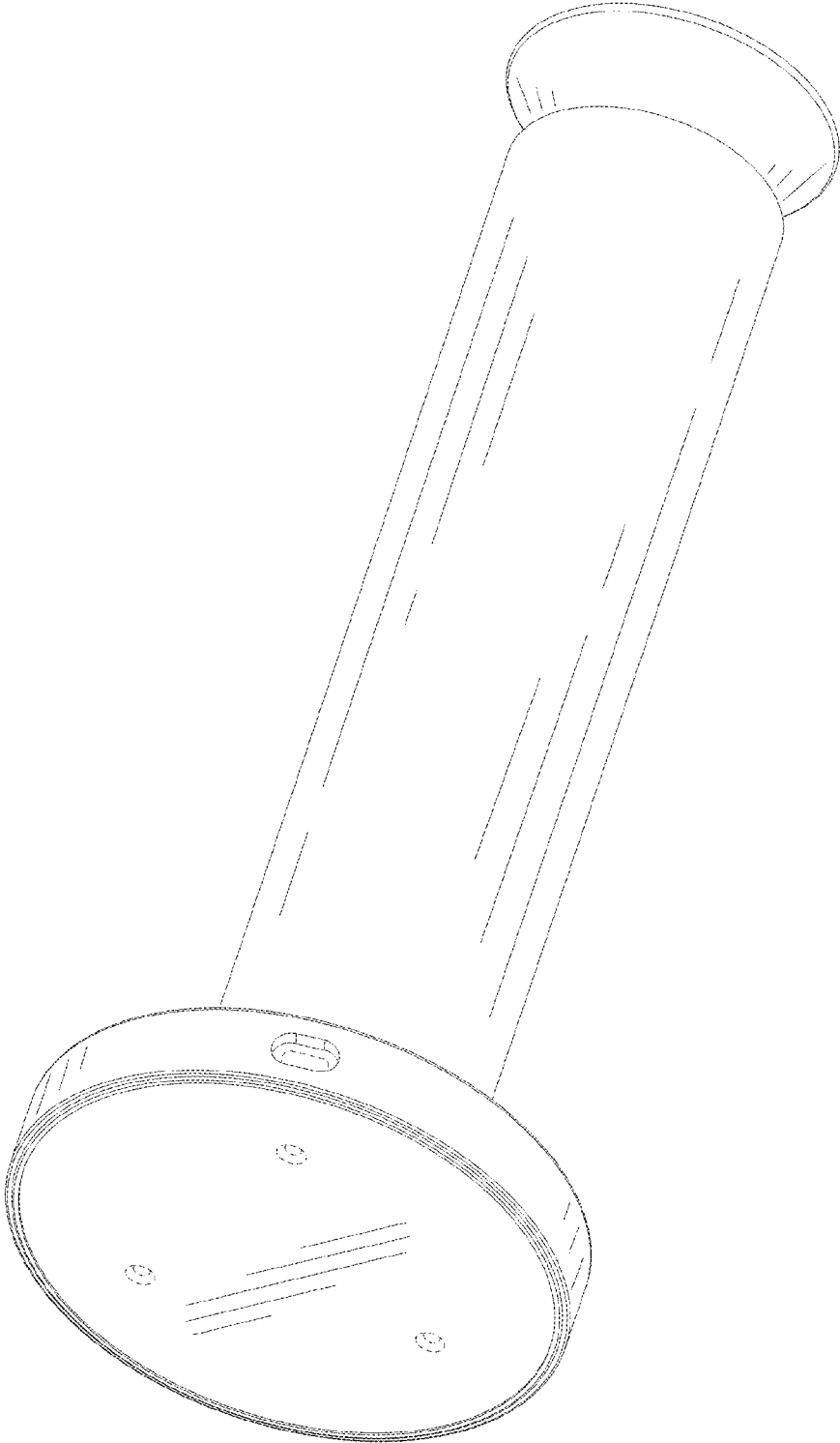

FIG. 2

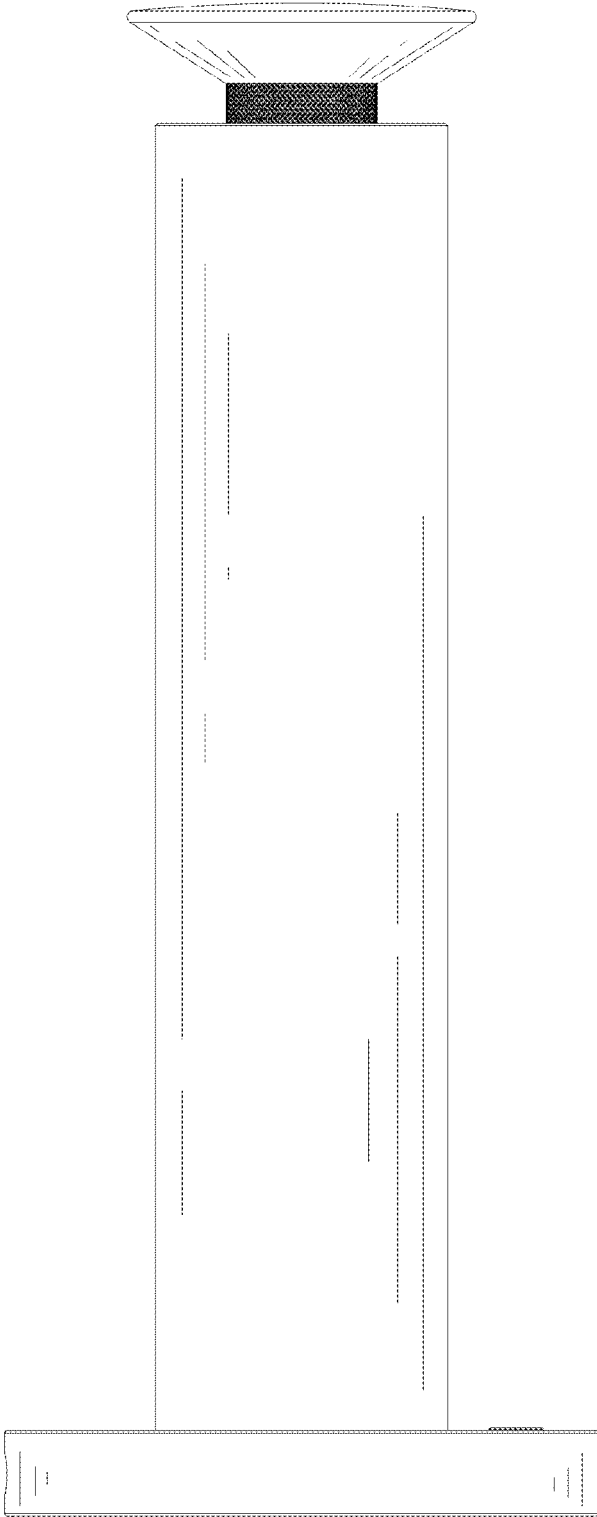

FIG. 3

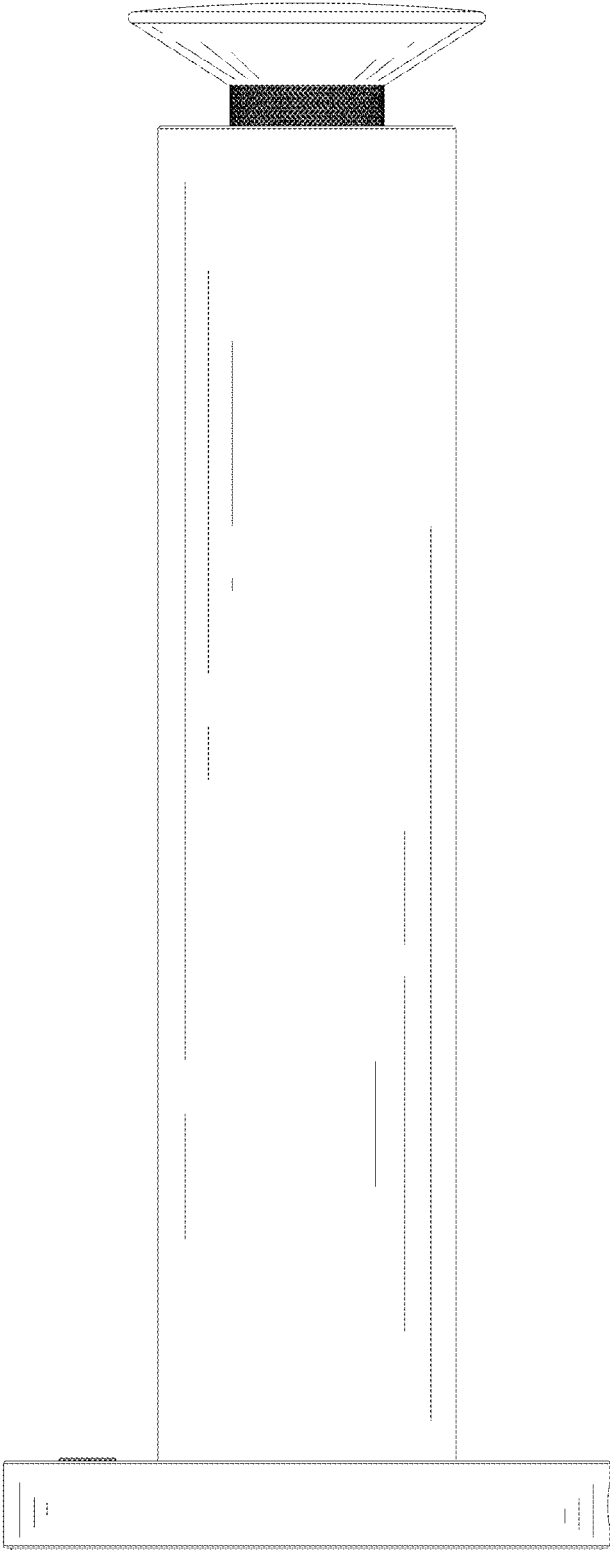

FIG. 4

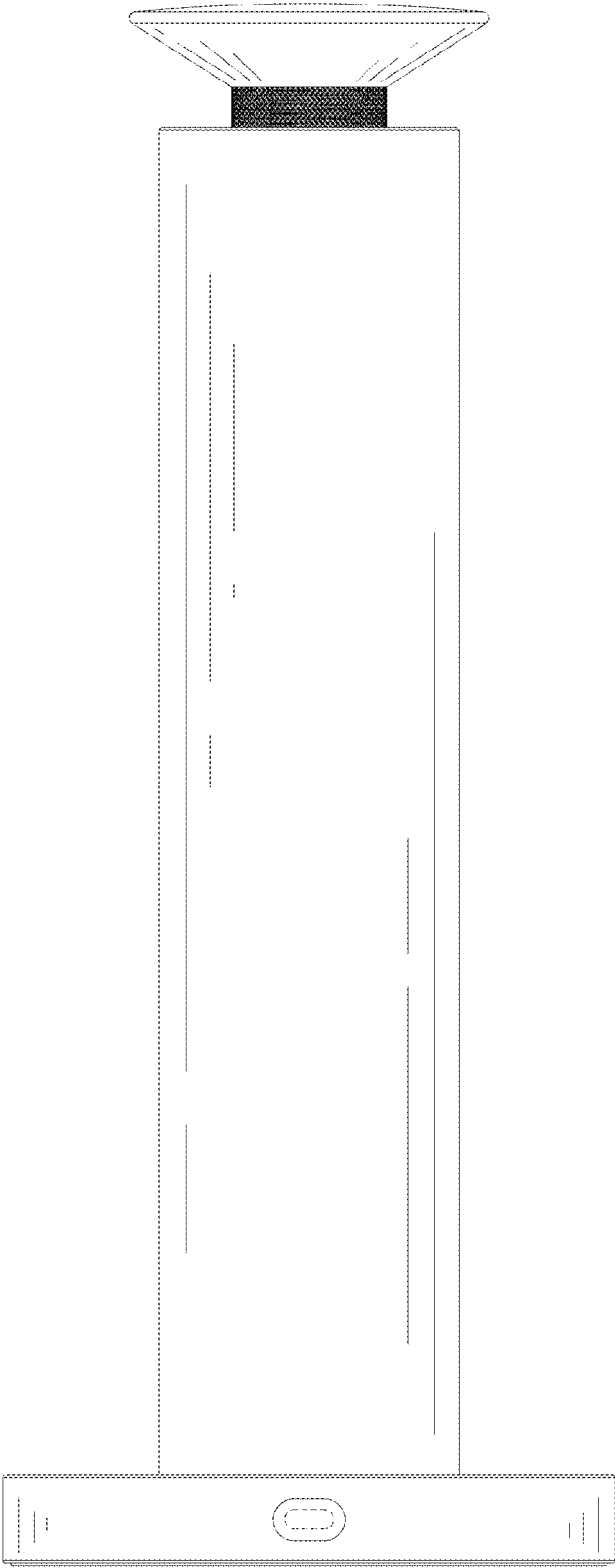

FIG. 5

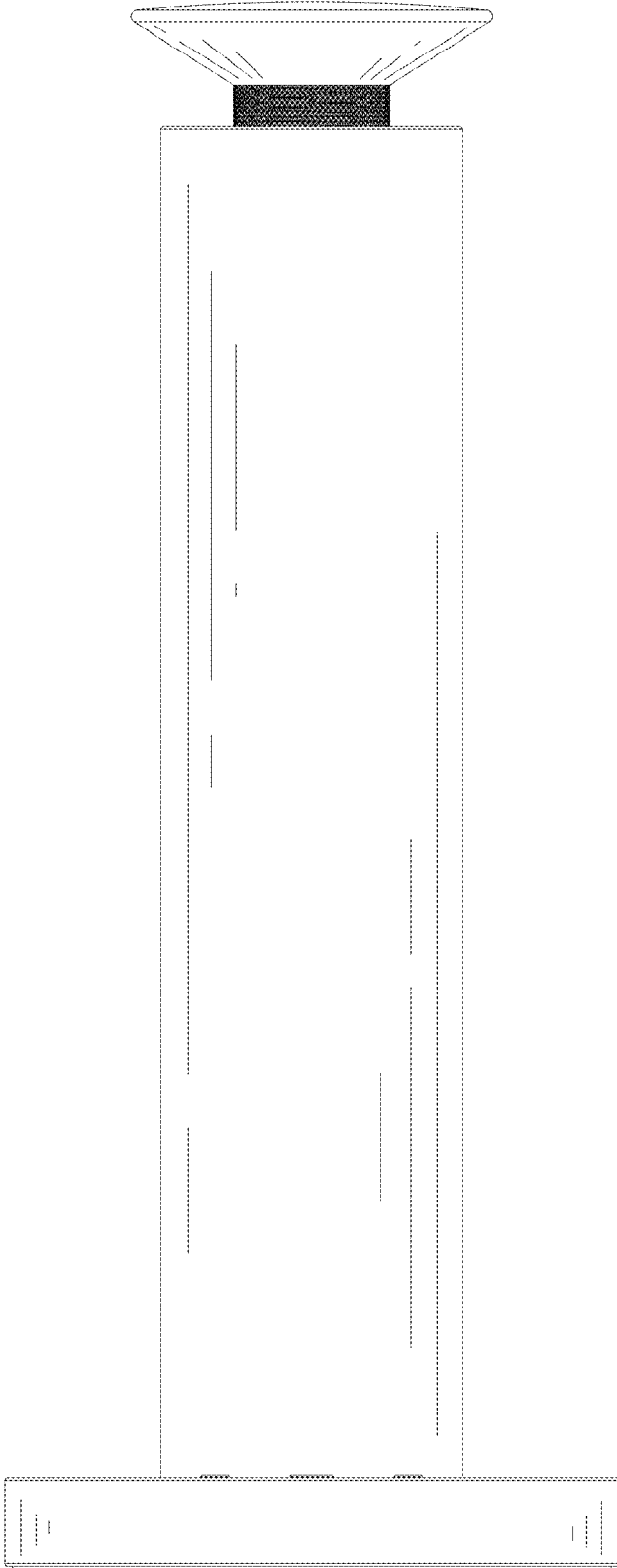

FIG. 6

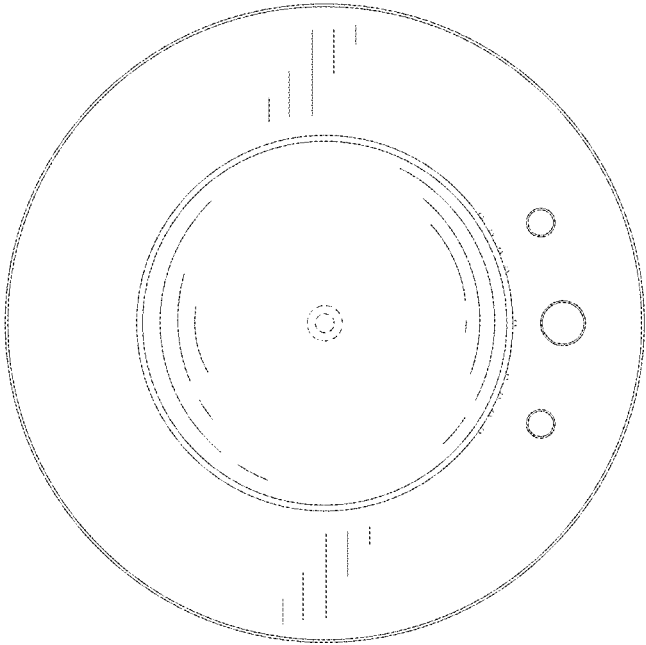

FIG. 7



FIG. 8

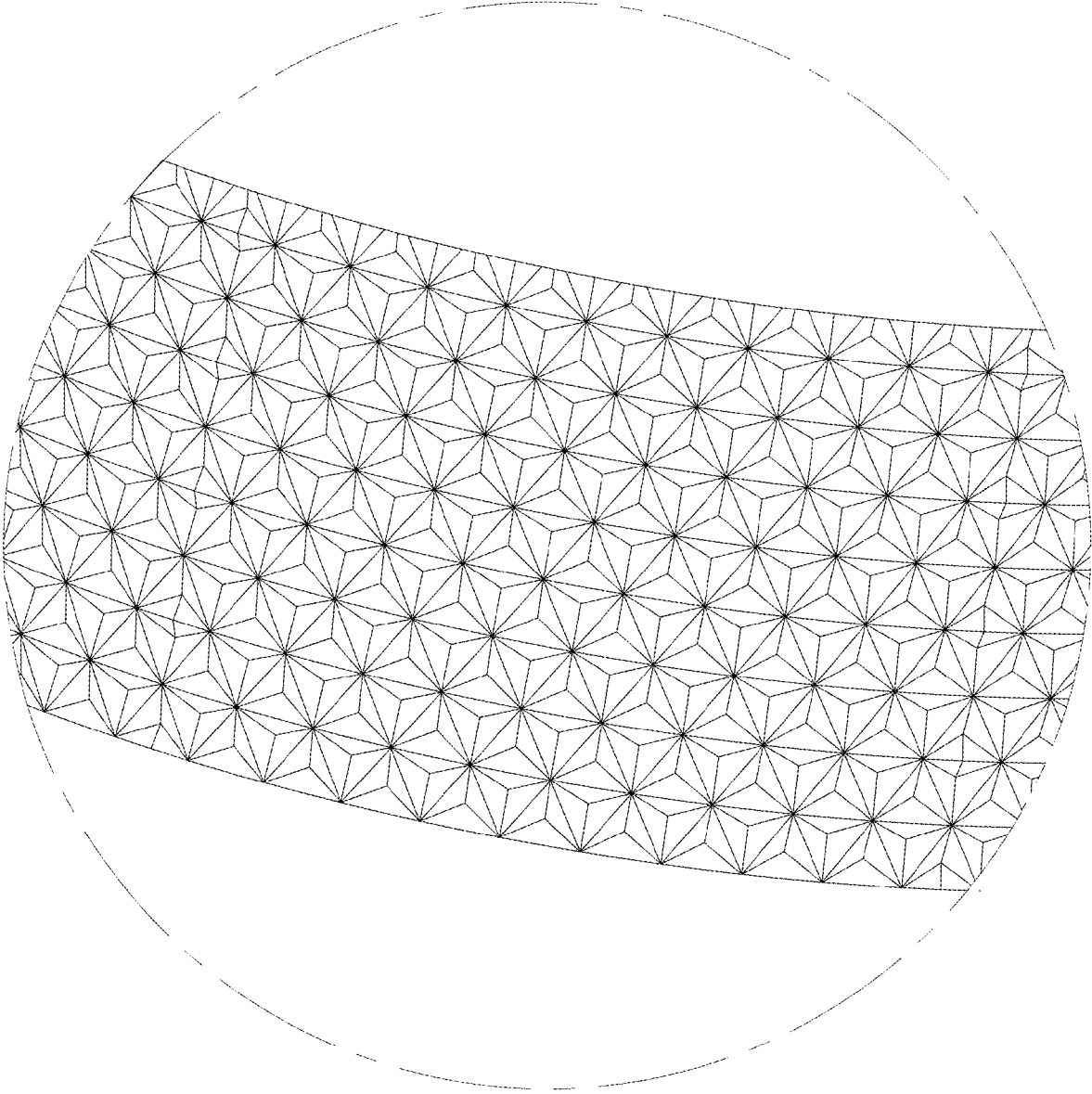

FIG. 9

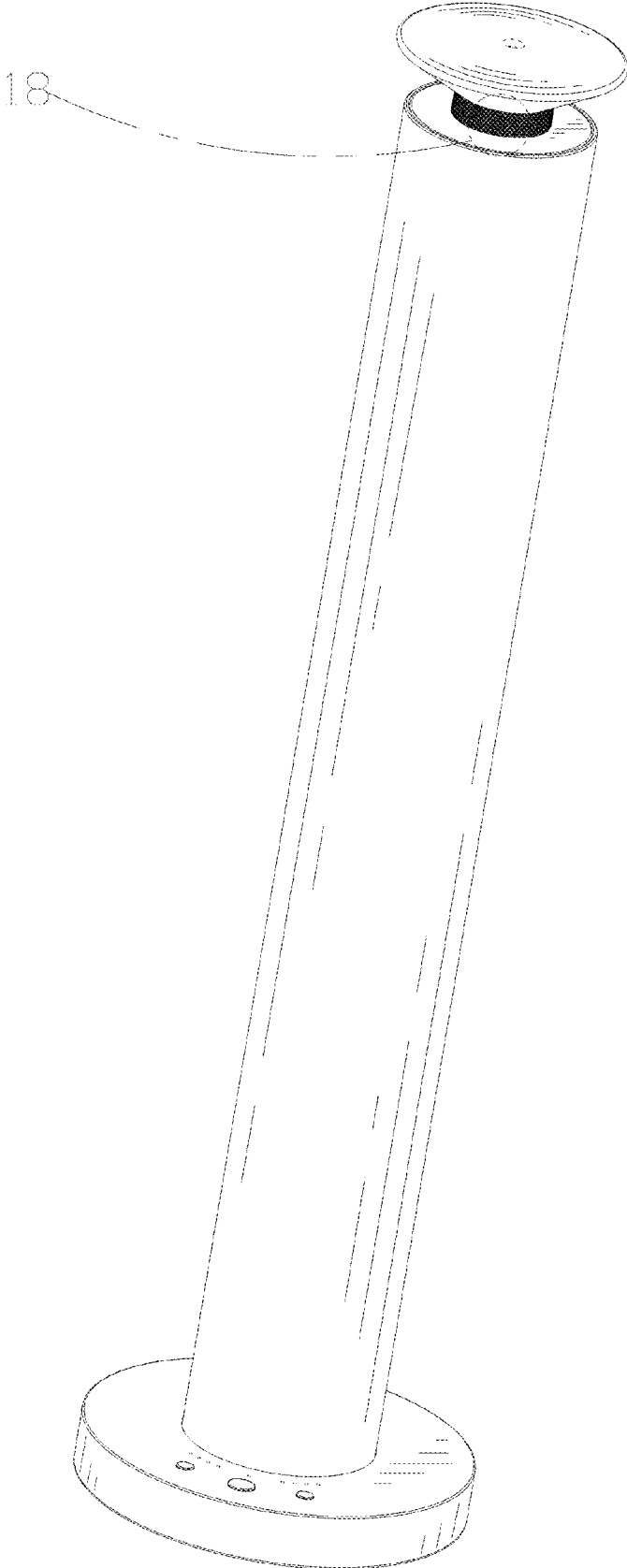

FIG. 10

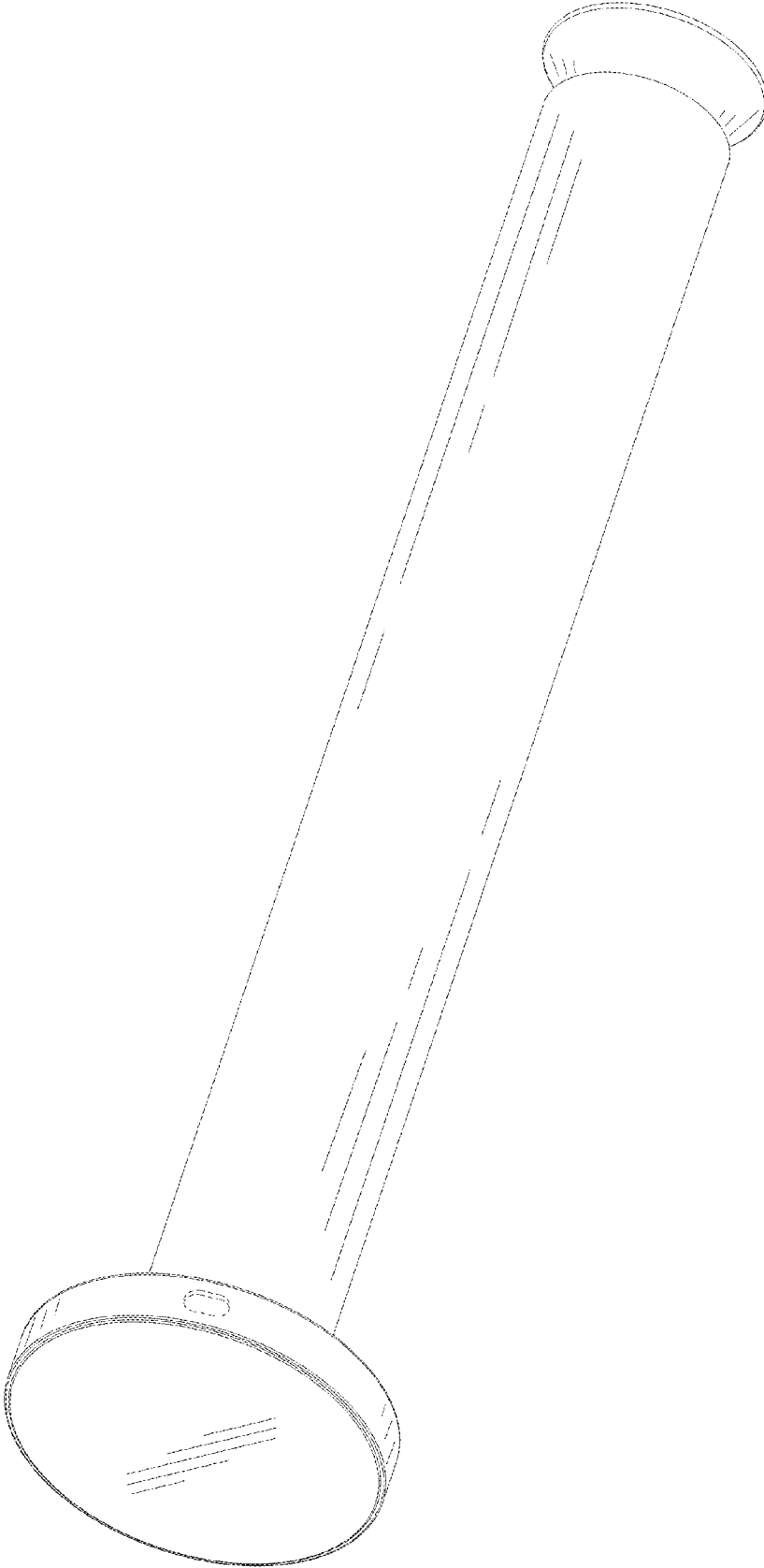

FIG. 11

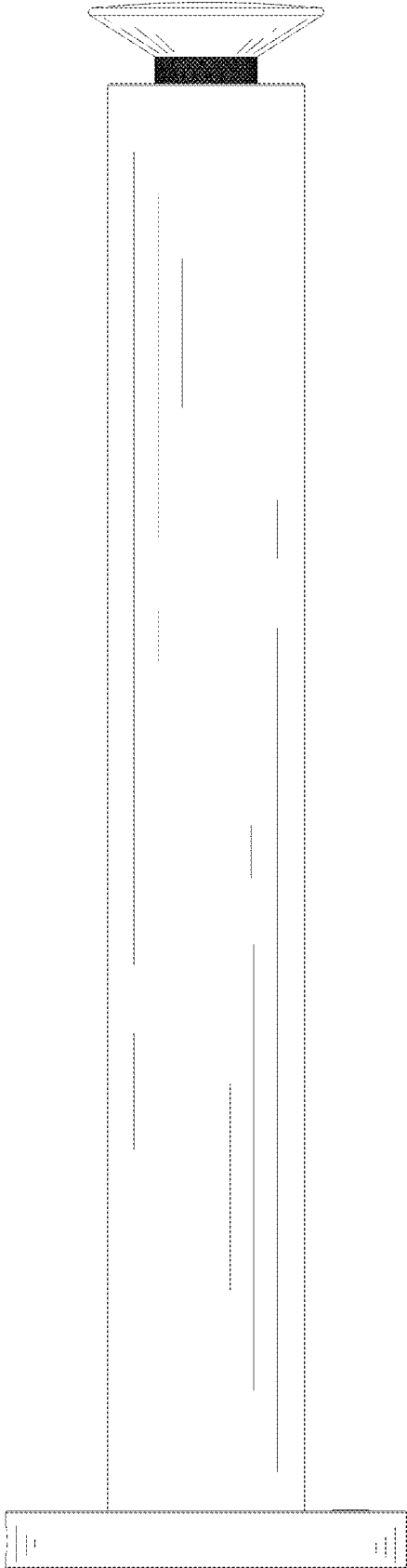

FIG. 12

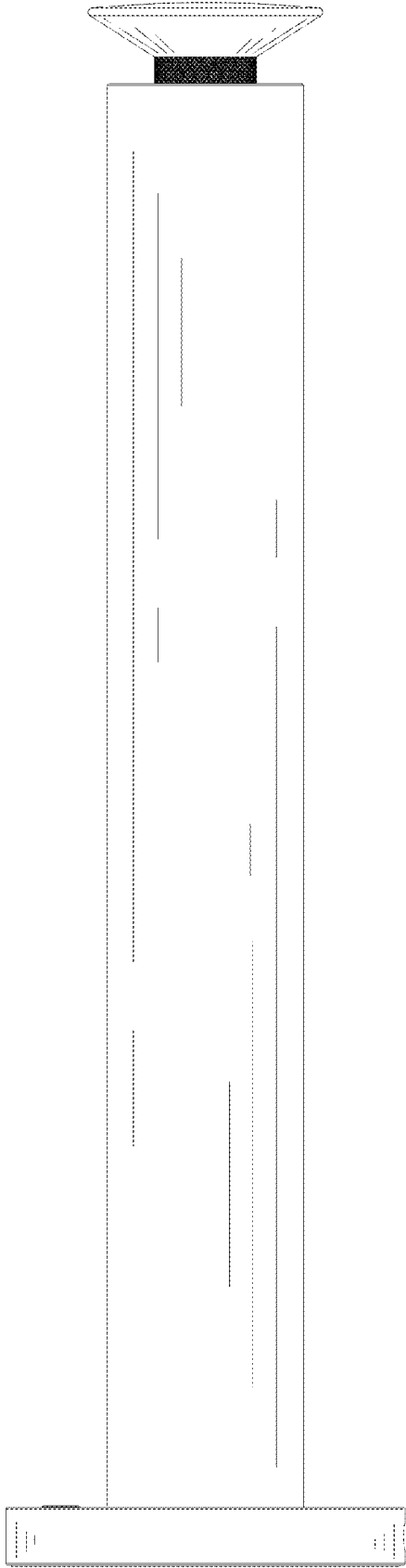

FIG. 13

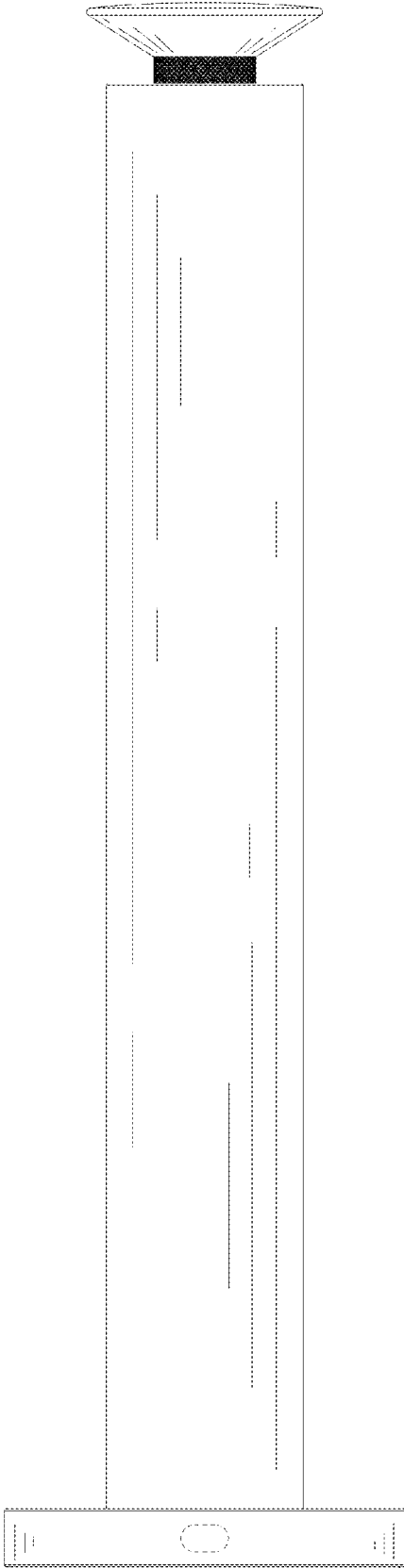

FIG. 14

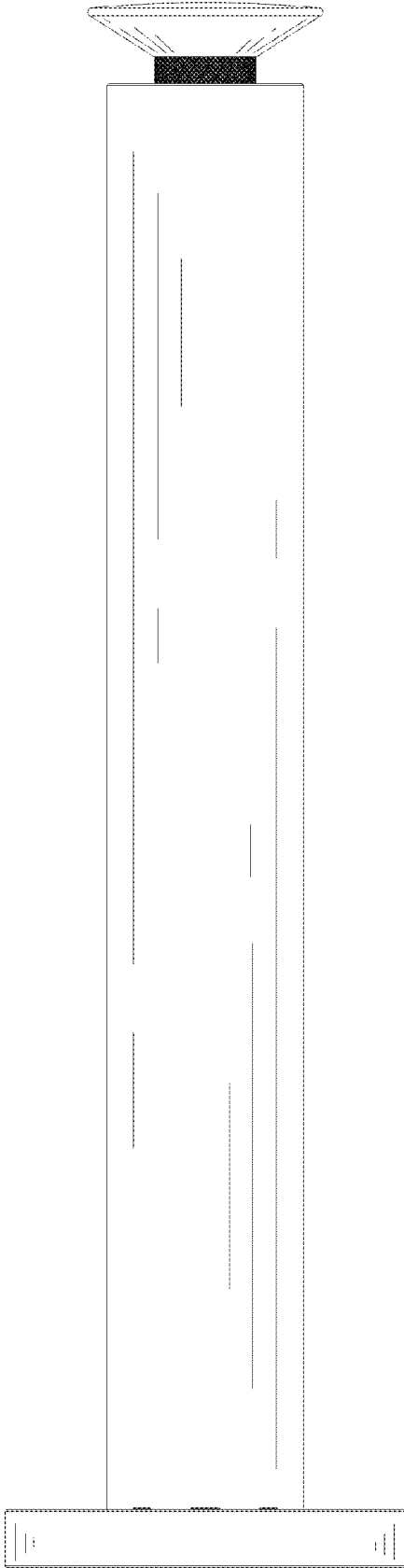

FIG. 15

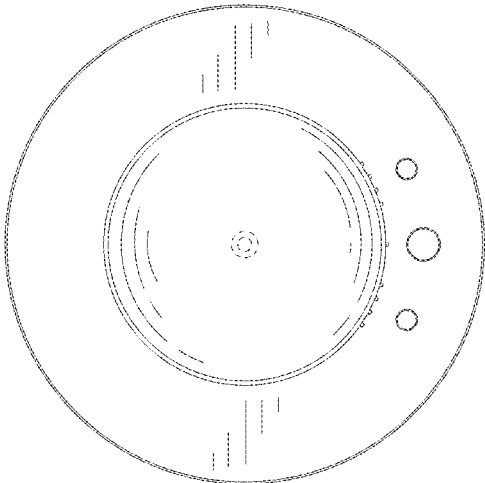

FIG. 16

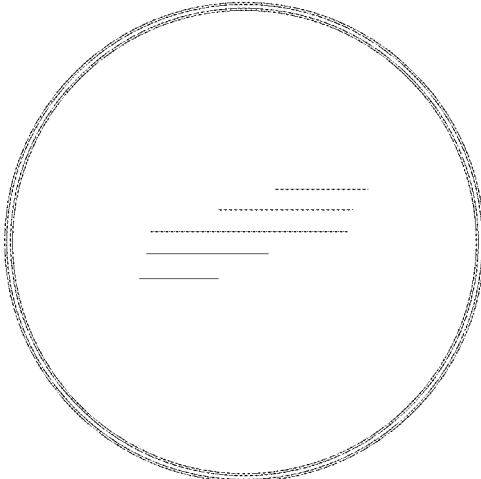

FIG. 17

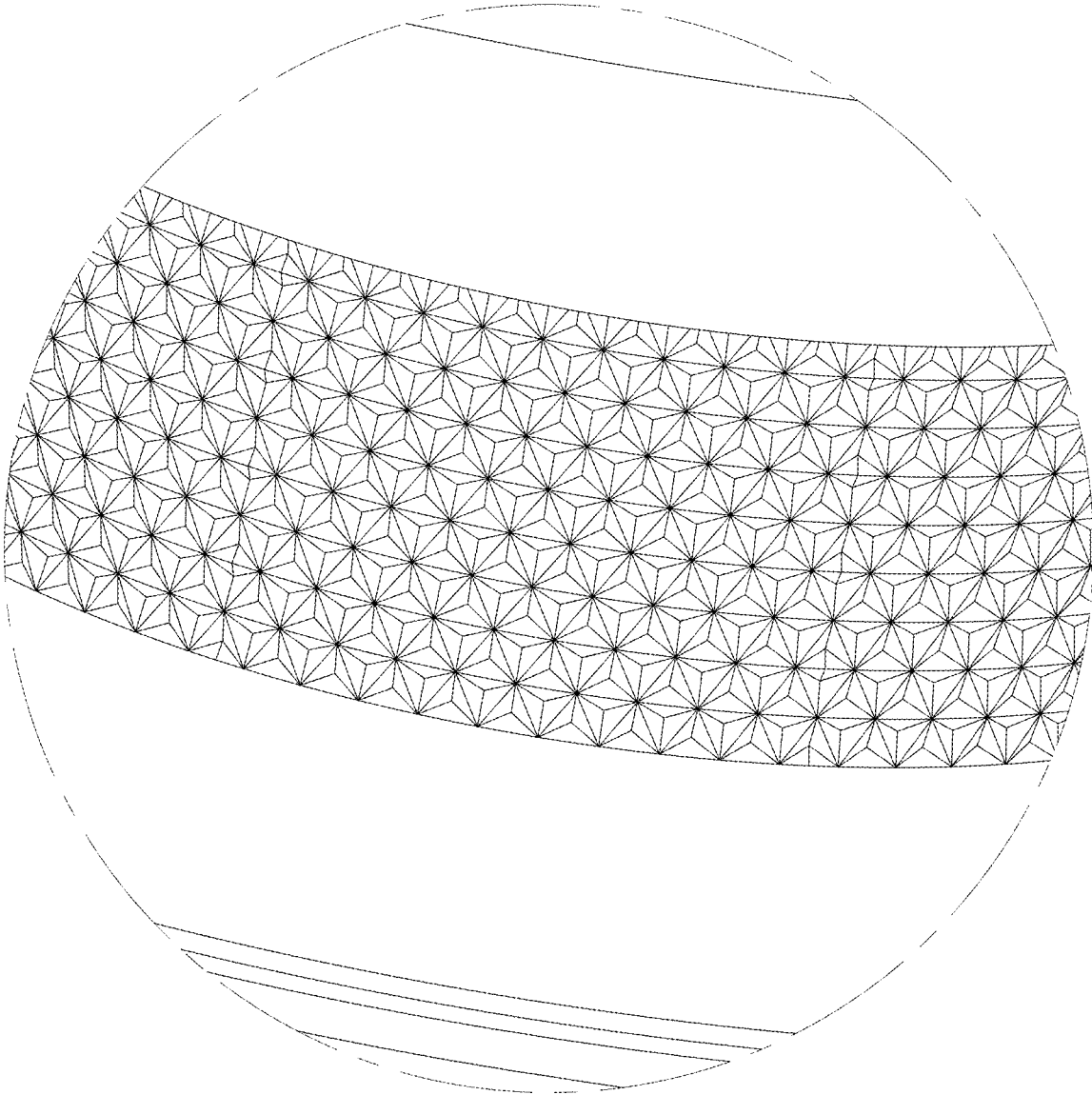

FIG. 18

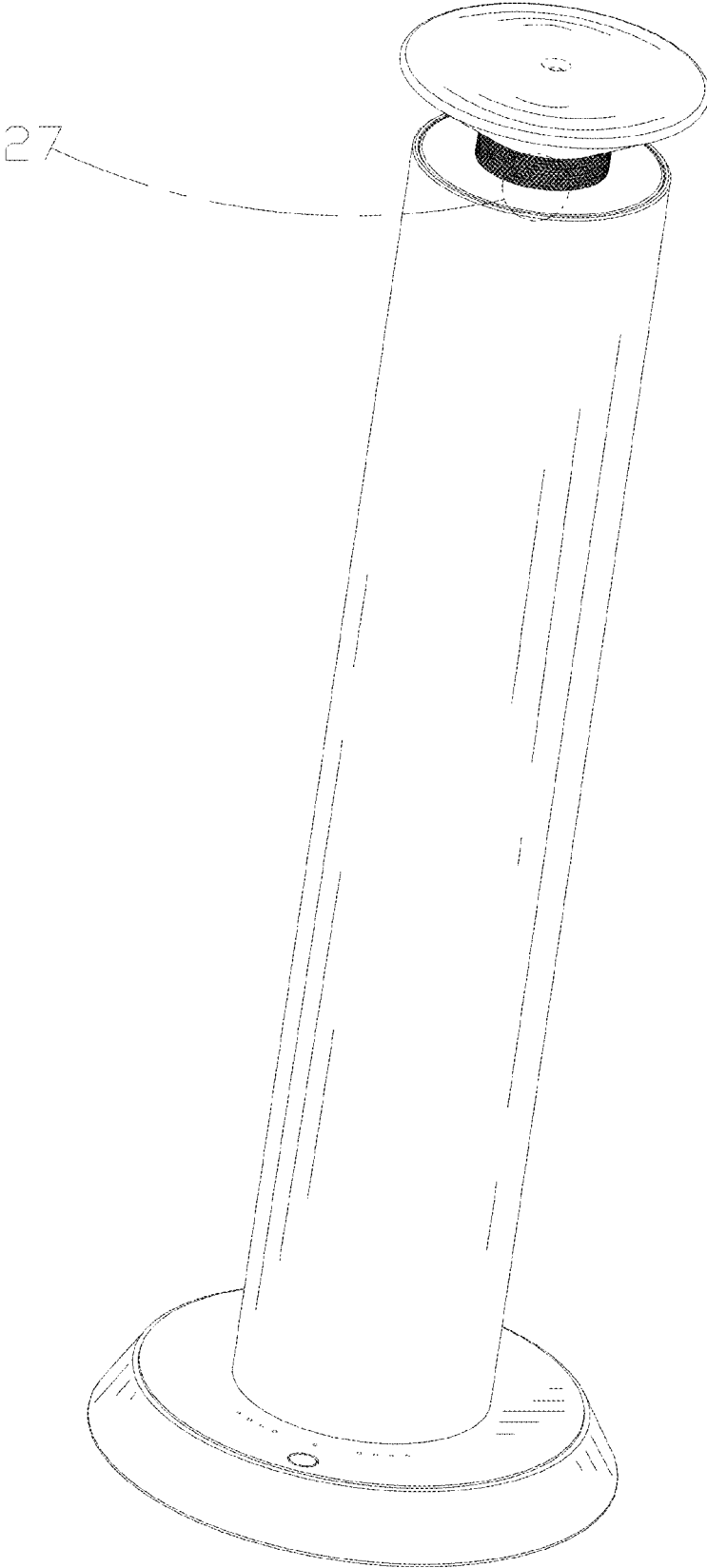

FIG. 19

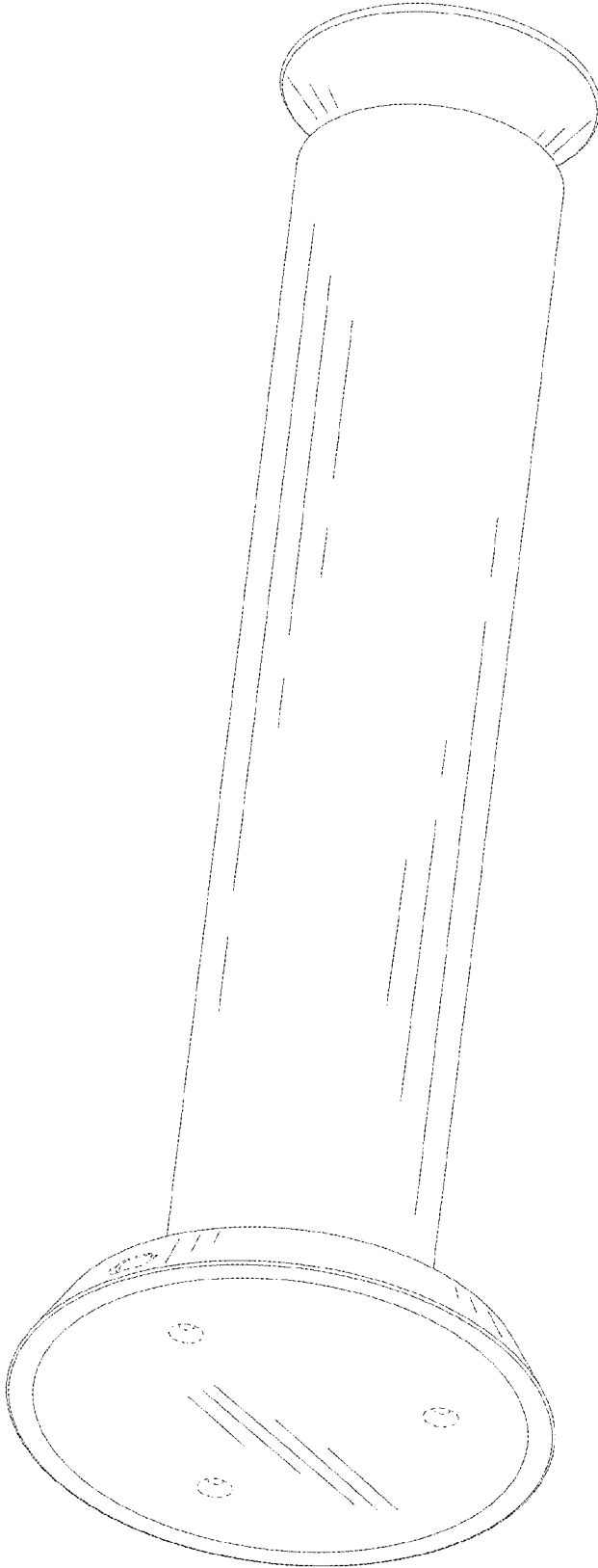

FIG. 20

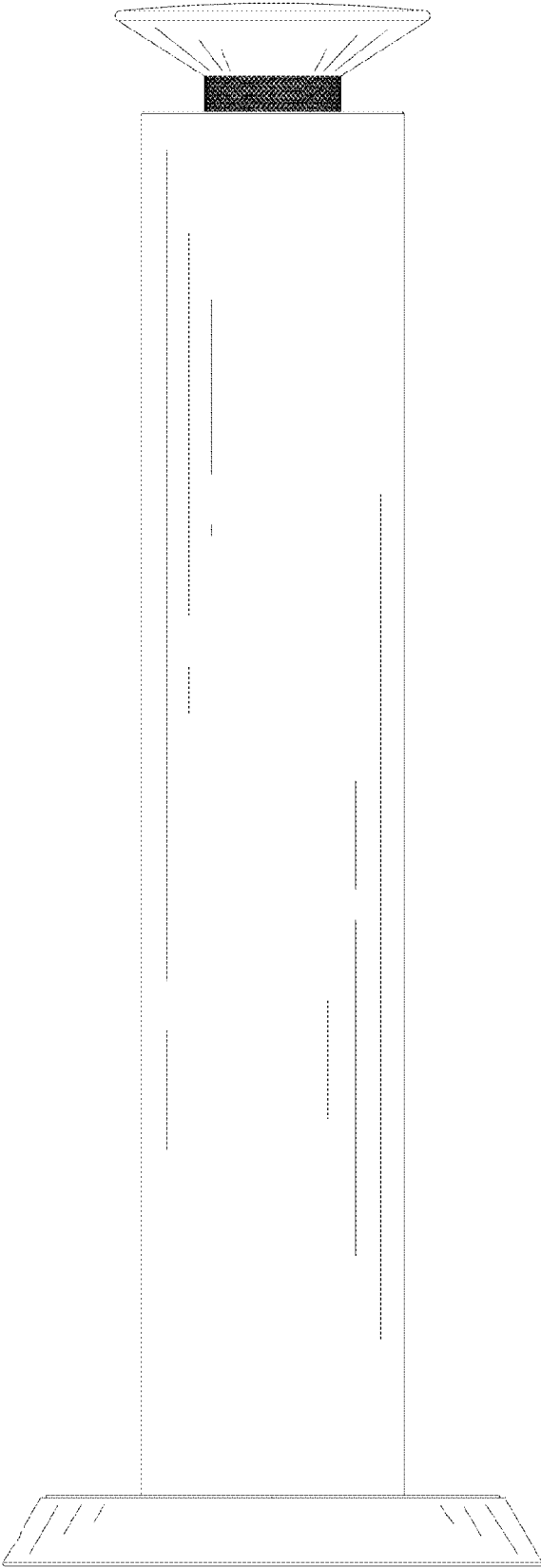

FIG. 21

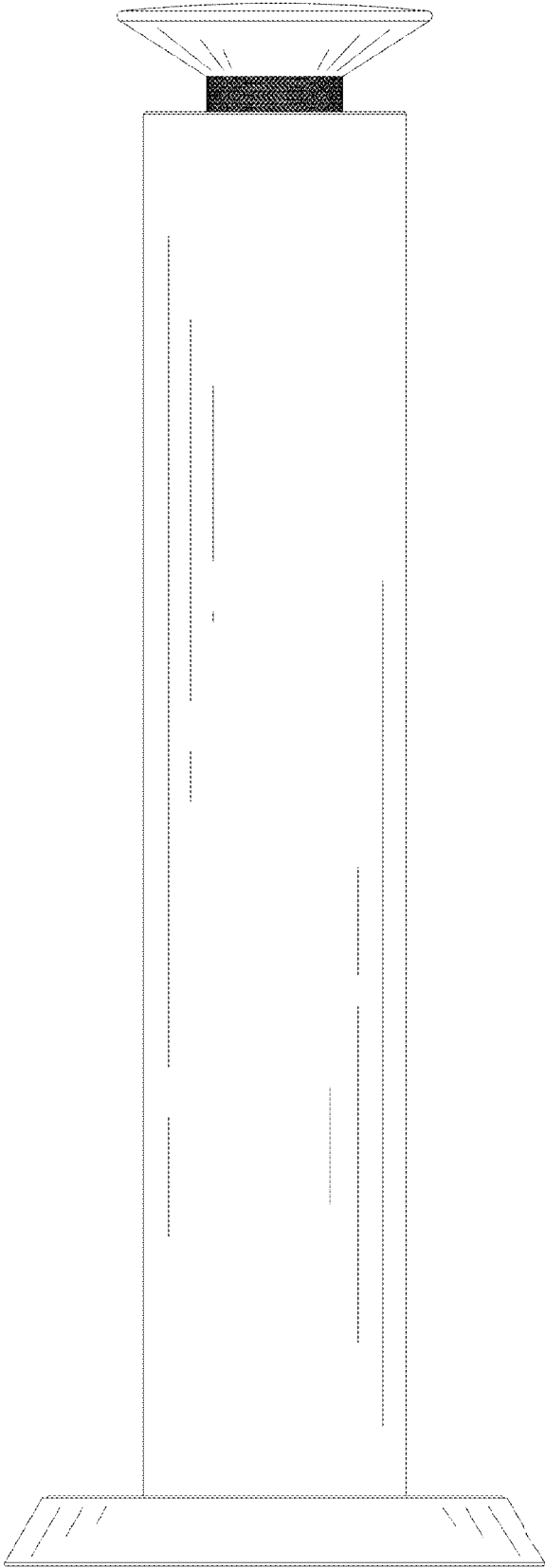

FIG. 22

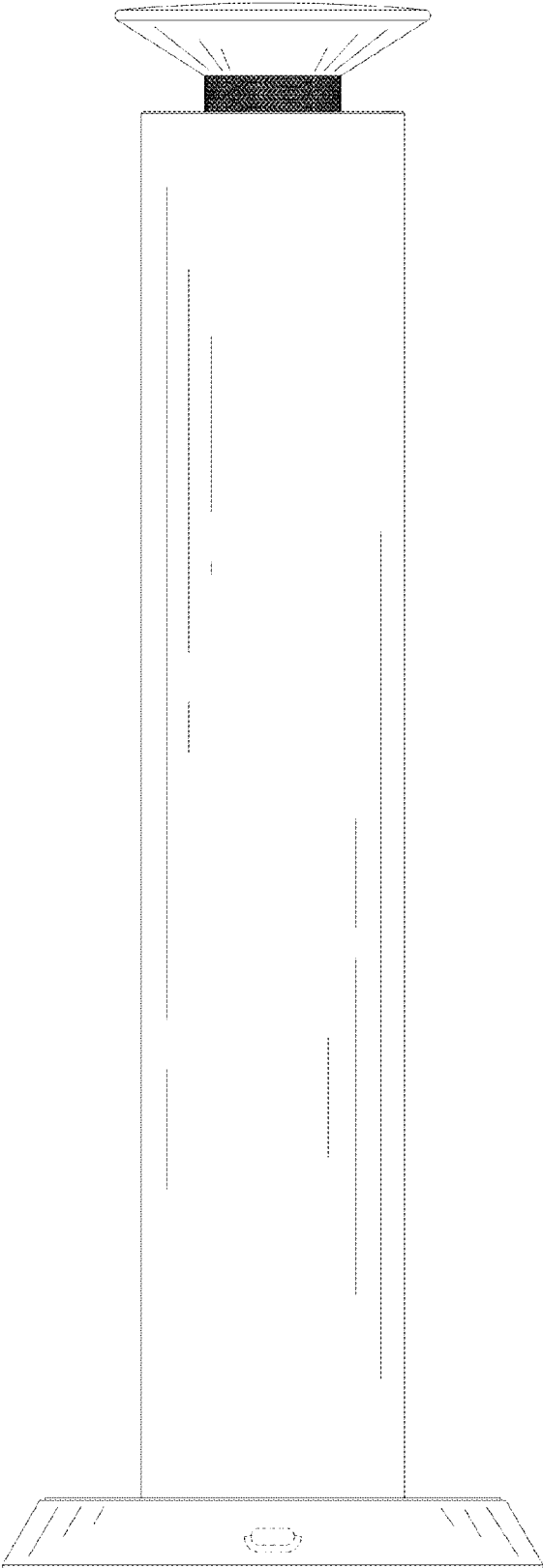

FIG. 23

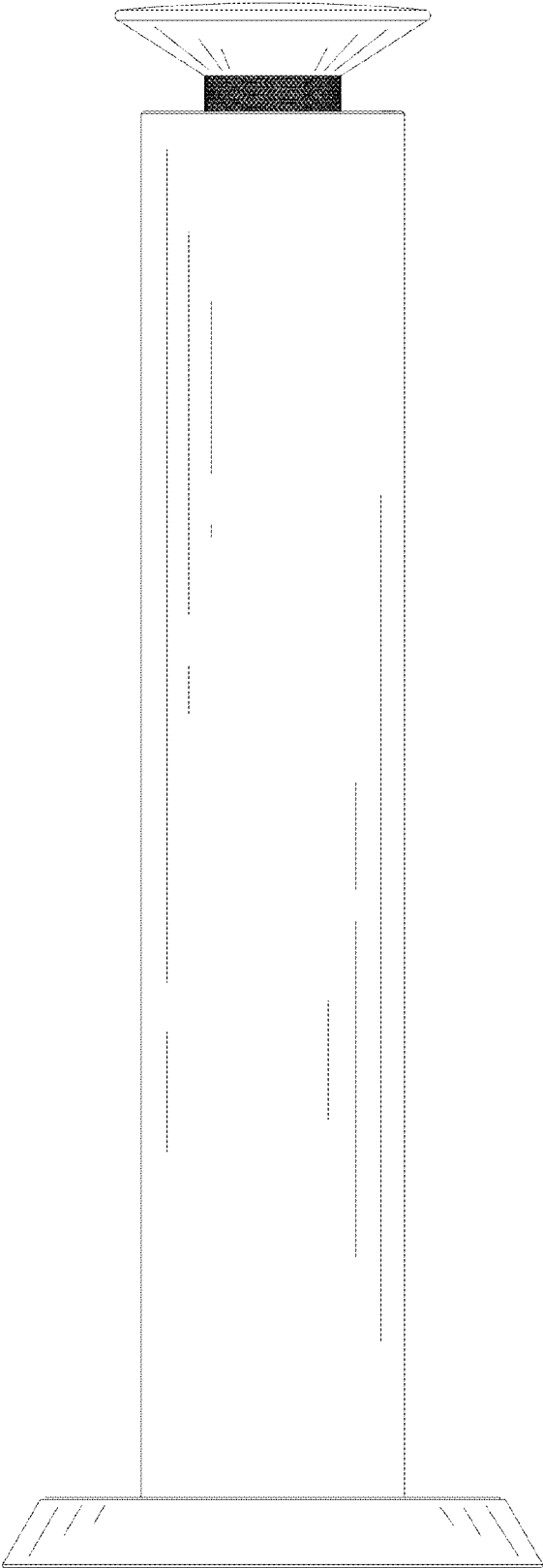

FIG. 24

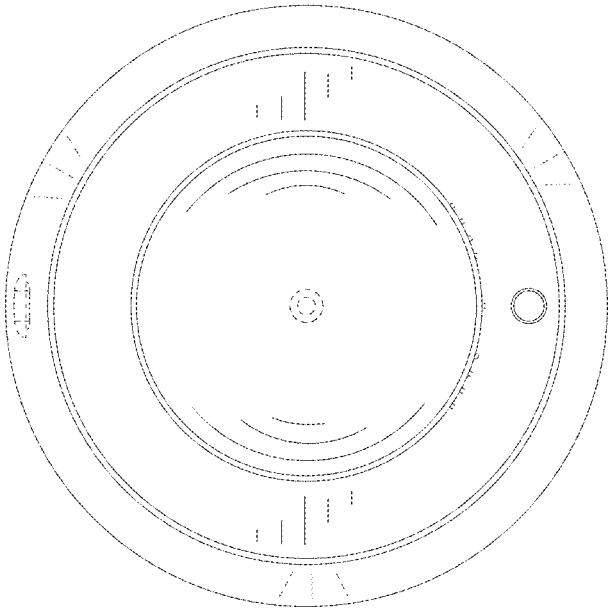

FIG. 25

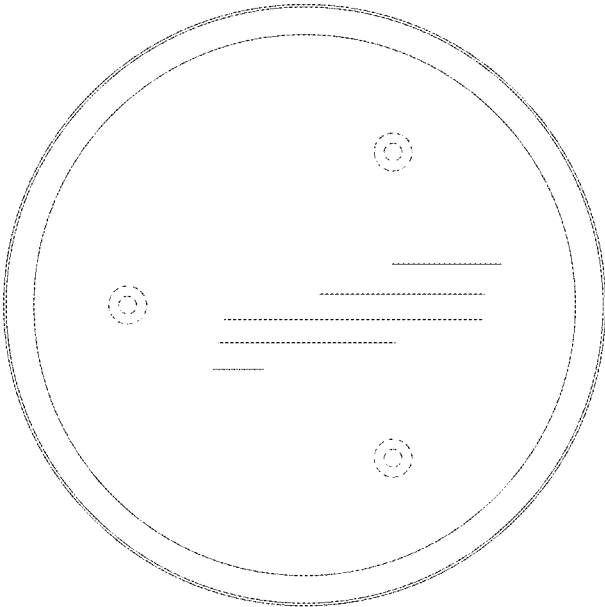

FIG. 26

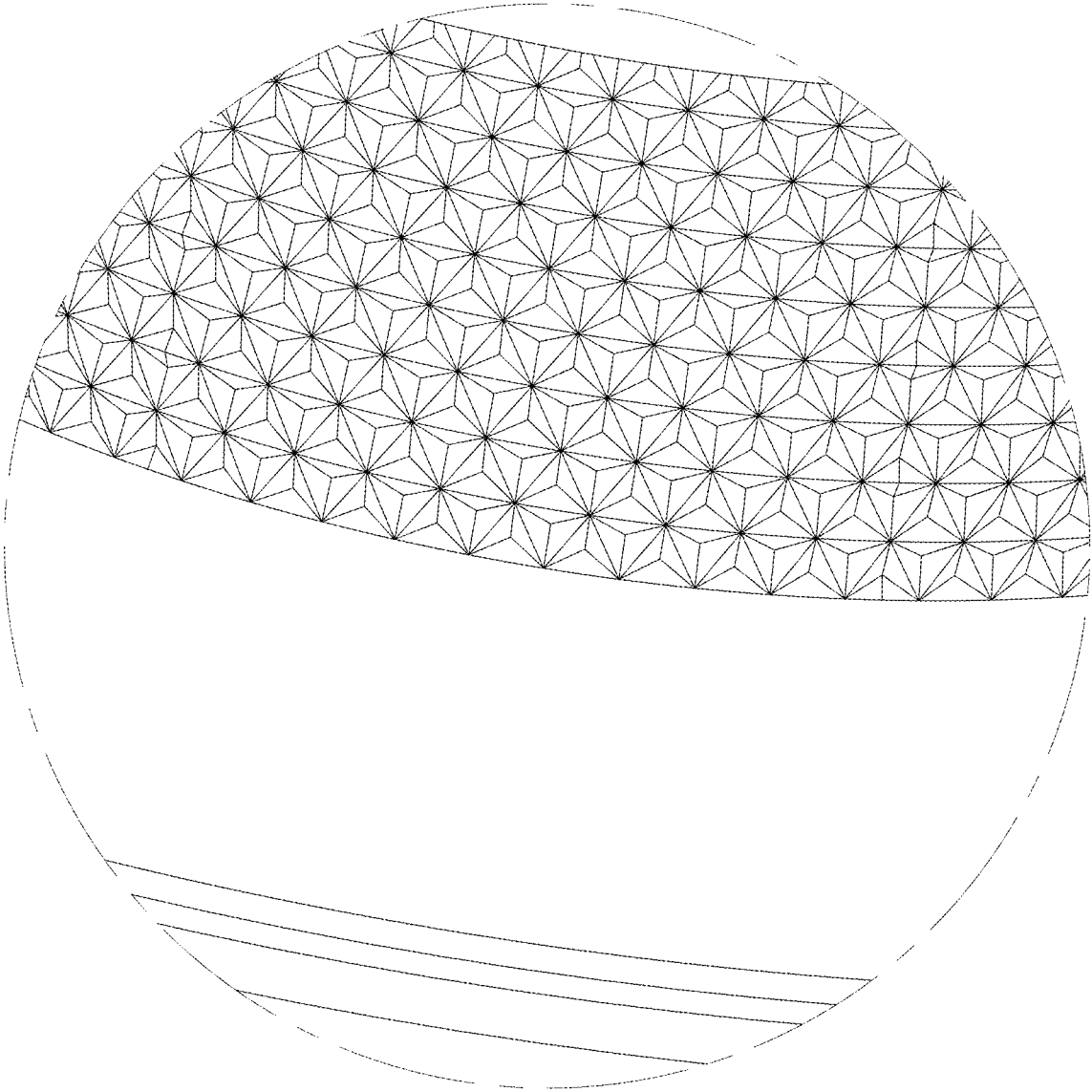

FIG. 27