



US00D452116B1

(12) **United States Design Patent** (10) **Patent No.:** **US D452,116 S**  
**McDonough et al.** (45) **Date of Patent:** **\*\* Dec. 18, 2001**

(54) **TRAINER CUP**

(76) Inventors: **Justin E. McDonough**, 12 Ballentine St., Kenvil, NJ (US) 07847; **Steve Aridgides**, 327 Michael Rd., Yardley, PA (US) 19067

(\*\*) Term: **14 Years**

(21) Appl. No.: **29/143,057**

(22) Filed: **Jun. 6, 2001**

**Related U.S. Application Data**

(60) Division of application No. 29/124,904, filed on Jun. 12, 2000, which is a continuation-in-part of application No. 29/116,372, filed on Dec. 30, 1999.

(51) **LOC (7) Cl.** ..... **07-01**

(52) **U.S. Cl.** ..... **D7/510; D7/511**

(58) **Field of Search** ..... **D7/509, 507, 510, D7/511, 514, 515, 532, 608, 536, 538, 606, 300.1, 523; D9/538; 220/729, 23.86, 715, 713, 674; 229/402; 206/520**

(56) **References Cited**

**U.S. PATENT DOCUMENTS**

4,138 8/1845 Pratt .

(List continued on next page.)

**FOREIGN PATENT DOCUMENTS**

88059 1/1984 (AU) .

(List continued on next page.)

**OTHER PUBLICATIONS**

Excerpt from publication by Herrmann, Bernd, Institute of Anthropology, Gottingen University, May 1990.

(List continued on next page.)

*Primary Examiner*—M. N. Pandozzi

(57) **CLAIM**

The ornamental design for a trainer cup, as shown.

**DESCRIPTION**

FIG. 1 is a perspective view of a first embodiment of a trainer cup showing our new design;

FIG. 2 is a front elevational view of the first embodiment; FIG. 3 is a rear elevational view of the first embodiment; FIG. 4 is a right side elevational view of the first embodiment; FIG. 5 is a left side elevational view of the first embodiment; FIG. 6 is a top plan view of the first embodiment; FIG. 7 is a bottom plan view of the first embodiment; FIG. 8 is a perspective view of a second embodiment of a trainer cup, having a different cap from the first embodiment; FIG. 9 is a front elevational view of the second embodiment; FIG. 10 is a rear elevational view of the second embodiment; FIG. 11 is a right side elevational view of the second embodiment; FIG. 12 is a left side elevational view of the second embodiment; FIG. 13 is a top plan view of the second embodiment; FIG. 14 is a bottom plan view of the second embodiment; FIG. 15 is a perspective view of a third embodiment of a trainer cup, having a body with feet and the same cap as the first embodiment; FIG. 16 is a front elevational view of the third embodiment; FIG. 17 is a rear elevational view of the third embodiment; FIG. 18 is a right side elevational view of the third embodiment; FIG. 19 is a left side elevational view of the third embodiment; FIG. 20 is a top view of the third embodiment; FIG. 21 is a bottom plan view of the third embodiment; FIG. 22 is a perspective view of a fourth embodiment of a trainer cup, having a body with feet and the same cap as the second embodiment; FIG. 23 is a front elevational view of the fourth embodiment; FIG. 24 is a rear elevational view of the fourth embodiment; FIG. 25 is a right side elevational view of the fourth embodiment; FIG. 26 is a left side elevational view of the fourth embodiment; FIG. 27 is a top plan view of the fourth embodiment; and, FIG. 28 is a bottom plan view of the fourth embodiment.

**1 Claim, 16 Drawing Sheets**

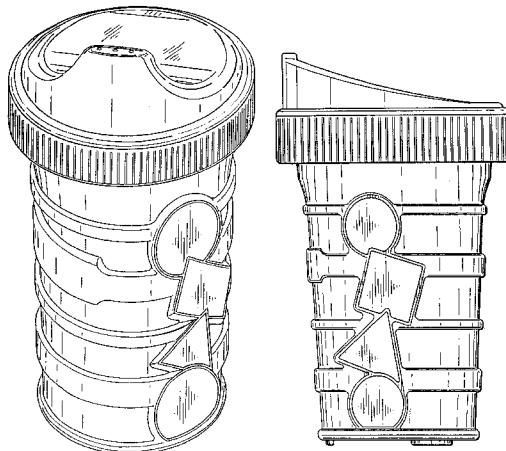

U.S. PATENT DOCUMENTS					
			4,450,977	5/1984	Colburn et al. .
			4,463,859	8/1984	Greene .
			4,524,805	6/1985	Hoffman .
			4,600,111	7/1986	Brown .
			4,616,768	10/1986	Flier .
			4,660,747	4/1987	Borg et al. .
			4,693,410	9/1987	Selz .
			4,723,668	2/1988	Cheng .
			4,728,006	3/1988	Drobish et al. .
			4,749,108	6/1988	Dornsbusch et al. .
			4,768,674	9/1988	Prescott .
			4,782,975	11/1988	Coy .
			4,909,416	3/1990	Evezich .
			4,946,062	8/1990	Coy .
			5,005,737	4/1991	Rohr .
			5,033,655	7/1991	Brown .
			5,035,340	7/1991	Timmons .
			5,040,756	8/1991	Via Cava .
			5,071,017	12/1991	Stull .
			5,079,013	1/1992	Belanger .
			5,096,082	3/1992	Hoefler .
			5,117,999	6/1992	Canzano et al. .
			5,147,066	9/1992	Snider .
			5,186,347	2/1993	Freeman et al. .
			5,213,236	5/1993	Brown et al. .
			5,222,623	6/1993	Eger et al. .
			5,261,459	11/1993	Atkinson et al. .
			5,339,995	8/1994	Brown et al. .
			5,363,983	11/1994	Proshan .
			5,370,258	12/1994	Fair .
			5,377,877	1/1995	Brown et al. .
			5,402,836	4/1995	Hasper et al. .
			5,409,144	4/1995	Brown .
			5,439,143	8/1995	Brown et al. .
			5,531,363	7/1996	Gross et al. .
			5,542,670	8/1996	Morano .
			5,626,262	5/1997	Fitten et al. .
			5,632,420	5/1997	Lohrman et al. .
			5,655,687	8/1997	Fitten et al. .
			5,676,289	10/1997	Gross et al. .
			5,680,969	10/1997	Gross .
			5,706,973	1/1998	Robbins, III et al. .
			5,758,790	6/1998	Ewing, Jr. .
			5,833,115	11/1998	Eiten .
			5,839,581	11/1998	Vagedes .
			5,839,614	11/1998	Brown .
			5,839,626	11/1998	Gross et al. .
			5,862,927	1/1999	Tebeau .
			5,871,118	2/1999	Franzese .
			5,890,619	4/1999	Belanger .
			5,890,620	4/1999	Belcastro .
			5,890,621	4/1999	Bachman et al. .
			5,893,472	4/1999	Forrer .
			5,894,952	4/1999	Mendenhall et al. .
			5,897,033	4/1999	Okawa et al. .
			5,904,275	5/1999	Suffa .
			5,924,605	7/1999	Baudin et al. .
			5,927,566	7/1999	Mueller .
			5,927,567	7/1999	Fillmore .
			5,934,512	8/1999	Lampe et al. .
			5,934,514	8/1999	Lampe et al. .
			5,938,086	8/1999	Gross .
			5,944,234	8/1999	Lampe et al. .
			5,950,857	9/1999	Rosen .
			5,954,237	9/1999	Lampe et al. .
			5,971,232	10/1999	Rohr et al. .
			5,975,354	11/1999	Goncalves .
Re. 30,805	11/1981	Rhoads .			
D. 239,358	3/1976	Kjellquist .			
D. 240,287	6/1976	Sepaneva et al. .			
D. 247,840	5/1978	Dixson .			
D. 346,932	* 5/1994	Cautereels et al. ....	D7/507		
D. 350,875	9/1994	VanValkenburg et al. .			
D. 362,156	* 9/1995	Goto et al. ....	D7/511		
D. 371,936	* 7/1996	Goto et al. ....	D7/523		
D. 374,147	* 10/1996	Lillelund et al. ....	D7/300.1		
D. 387,619	12/1997	Gross et al. .			
D. 395,202	* 6/1998	Ochs, Sr. ....	D7/606		
D. 398,813	9/1998	Franzese .			
D. 401,508	* 11/1998	Brown, III ....	D9/538		
D. 401,808	* 12/1998	Grivsky ....	D7/536		
D. 404,613	* 1/1999	Hatsumoto et al. ....	D7/510		
D. 407,269	* 3/1999	Fletcher ....	D7/510		
D. 408,220	* 4/1999	Chomik ....	D7/510		
D. 408,689	* 4/1999	Kato ....	D7/608		
D. 410,174	* 5/1999	Sheu ....	D7/510		
D. 412,085	7/1999	Roush et al. .			
D. 413,067	8/1999	Haley .			
D. 414,655	* 10/1999	Schwarz ....	D7/514		
D. 415,429	10/1999	Rausch .			
D. 415,654	10/1999	Forrer .			
D. 416,757	* 11/1999	Ginuntoli ....	D7/523		
D. 417,590	* 12/1999	Kato ....	D7/510		
D. 417,591	* 12/1999	Roehrig ....	D7/510		
D. 417,821	* 12/1999	Cautereels ....	D7/532		
D. 421,877	* 3/2000	La Torre et al. ....	D7/510		
D. 421,878	* 3/2000	Roehrig ....	D7/510		
D. 422,179	* 4/2000	Stephenson ....	D7/510		
D. 427,017	* 6/2000	Reimer ....	D7/516		
D. 428,306	* 7/2000	Lee ....	D7/510		
D. 431,159	9/2000	Otake .			
D. 431,160	9/2000	Stadtler, II .			
D. 434,273	11/2000	Johansen et al. .			
1,206,661	11/1916	Booth .			
1,825,553	9/1931	Smith .			
2,175,052	10/1939	Bull et al. .			
2,223,179	11/1940	Lougheed .			
2,328,382	8/1943	Langdon .			
2,758,755	8/1956	Schafier .			
2,816,548	12/1957	Tupper .			
3,139,064	6/1964	Harle .			
3,360,169	12/1967	Susuki et al. .			
3,438,527	4/1969	Gamblin, Jr. .			
3,504,699	4/1970	Grisé .			
3,517,682	6/1970	Smith .			
3,635,380	1/1972	Fitzgerald .			
3,650,271	3/1972	Pelli .			
3,674,183	7/1972	Venable et al. .			
3,718,140	2/1973	Yamauchi .			
3,773,233	11/1973	Souza .			
3,825,157	7/1974	Herzig .			
3,860,162	1/1975	Schutz .			
3,905,512	9/1975	Albert et al. .			
3,915,331	10/1975	Chenault .			
3,924,767	12/1975	Arrandale et al. .			
4,002,168	1/1977	Petterson .			
4,133,457	1/1979	Klassen .			
4,184,604	1/1980	Amberg et al. .			
4,186,842	2/1980	Albert .			
4,245,752	1/1981	Prueher .			
4,350,260	9/1982	Prueher .			
4,412,629	11/1983	Dart et al. .			
4,441,623	4/1984	Antoniak .			

5,988,425 11/1999 Yehl et al. .  
6,050,445 4/2000 Manganiello .

## FOREIGN PATENT DOCUMENTS

4068785	10/1985	(AU) .	2226014A	6/1990	(GB) .
97711	8/1987	(AU) .	2227159A	7/1990	(GB) .
595296	9/1987	(AU) .	2266045B	10/1993	(GB) .
98916	12/1987	(AU) .	2279130A	12/1994	(GB) .
99599	2/1988	(AU) .	2285621A	7/1995	(GB) .
647010	8/1990	(AU) .	2304545A	3/1997	(GB) .
655291	12/1992	(AU) .	2304545B	3/1997	(GB) .
118128	9/1993	(AU) .	2311061A	9/1997	(GB) .
118493	10/1993	(AU) .	2314497A	1/1998	(GB) .
118899	11/1993	(AU) .	2314497B	1/1998	(GB) .
684061	1/1994	(AU) .	2317608A	4/1998	(GB) .
7943694	5/1995	(AU) .	699693	2/1987	(JP) .
715393	2/1997	(AU) .	699694	2/1987	(JP) .
6881196	3/1997	(AU) .	6996931	3/1987	(JP) .
9113098	3/1999	(AU) .	738127	7/1988	(JP) .
1369599	5/1999	(AU) .	775839	11/1989	(JP) .
2291399	8/1999	(AU) .	880081	10/1993	(JP) .
2586099	8/1999	(AU) .	900603	6/1994	(JP) .
138675	10/1999	(AU) .	946622	2/1996	(JP) .
138676	10/1999	(AU) .	946624	2/1996	(JP) .
1296600	6/2000	(AU) .	967767	11/1996	(JP) .
141078	7/2000	(AU) .	1025434	11/1998	(JP) .
141080	7/2000	(AU) .	1056829	12/1999	(JP) .
2454500	9/2000	(AU) .	1056837	12/1999	(JP) .
3424600	9/2000	(AU) .	1083150	8/2000	(JP) .
2128875	12/1972	(DE) .	1107210	4/2001	(JP) .
2538007	3/1976	(DE) .	8401143	3/1984	(WO) .
29714169	11/1997	(DE) .	8504086	9/1985	(WO) .
0152494	8/1985	(EP) .	9319718	10/1993	(WO) .
0160336	11/1985	(EP) .	9400363	1/1994	(WO) .
0278125	8/1988	(EP) .	9404023	3/1994	(WO) .
0326743	8/1989	(EP) .	9405552	3/1994	(WO) .
0382631	8/1990	(EP) .	9510965	4/1995	(WO) .
0384394	8/1990	(EP) .	9513220	5/1995	(WO) .
0442379	8/1991	(EP) .	9521097	8/1995	(WO) .
0495435	7/1992	(EP) .	9521098	8/1995	(WO) .
0495440	7/1992	(EP) .	9708979	3/1997	(WO) .
0545678	6/1993	(EP) .	9817157	4/1998	(WO) .
0555623	8/1993	(EP) .	9818427	5/1998	(WO) .
0591601	4/1994	(EP) .	9820832	5/1998	(WO) .
0634922	1/1995	(EP) .	9908578	2/1999	(WO) .
0723413	7/1996	(EP) .	9939617	8/1999	(WO) .
0838184	4/1998	(EP) .			
1364891	5/1964	(FR) .			
2624102	6/1989	(FR) .			
1253398	11/1971	(GB) .			
2015350	9/1979	(GB) .			
2029379A	3/1980	(GB) .			
2131301A	6/1984	(GB) .			
2169210A	7/1986	(GB) .			
2169210B	7/1986	(GB) .			
2183225A	6/1987	(GB) .			
2190073B	11/1987	(GB) .			

## OTHER PUBLICATIONS

Excerpt from *The Bounty BabyCare Guide*, © Bounty Services Ltd, 1991.

Excerpt from *Baby Care Products 1992*, showing Púr products.

Press Release by Maws of Hertford, England, Apr. 1992.

Perfect Ideas from Tommee Tippee, *Chemist & Druggist*, Aug. 15, 1992, p. 264.

New Visions Mealtimes 1998–1999 Catalog, Faber, Virginia.

Púr Catalog, undated.

\* cited by examiner

*FIG. 1*

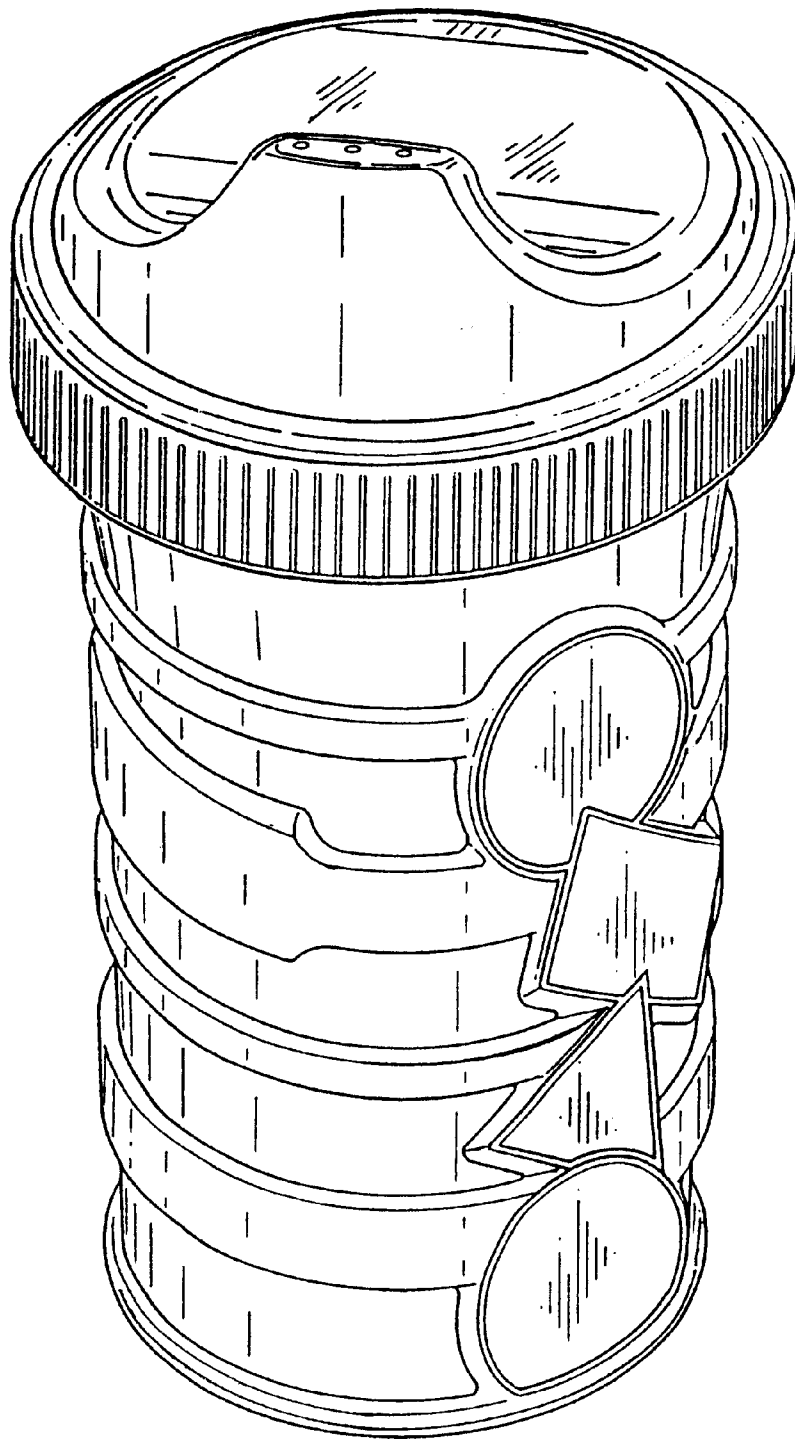

FIG. 3

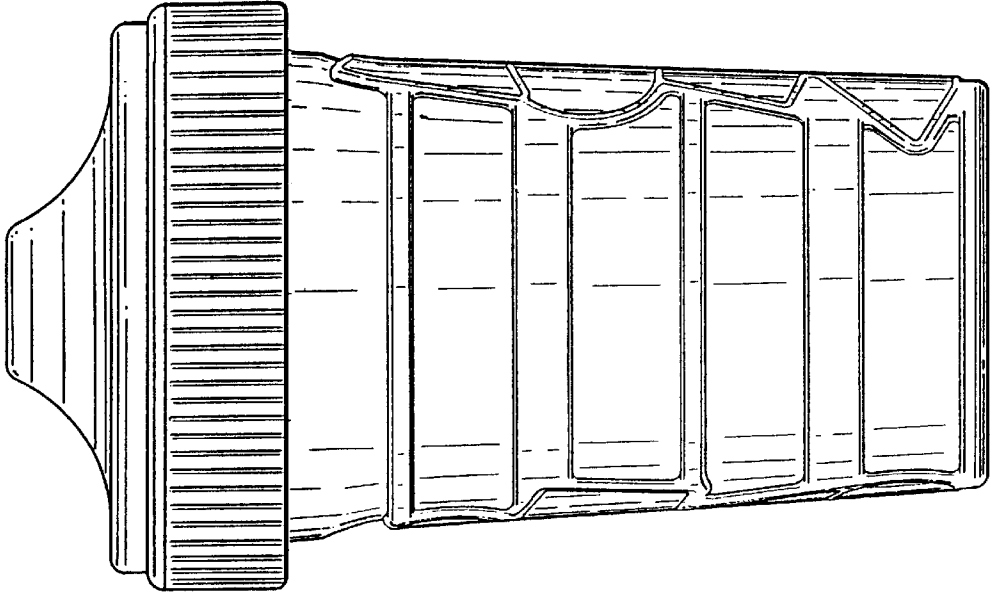

FIG. 2

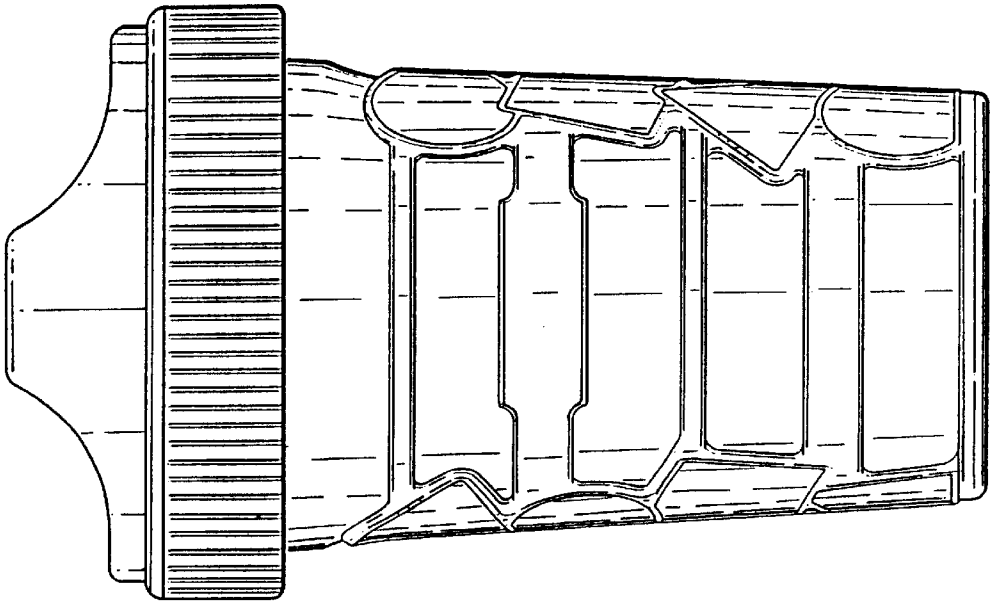

FIG. 5

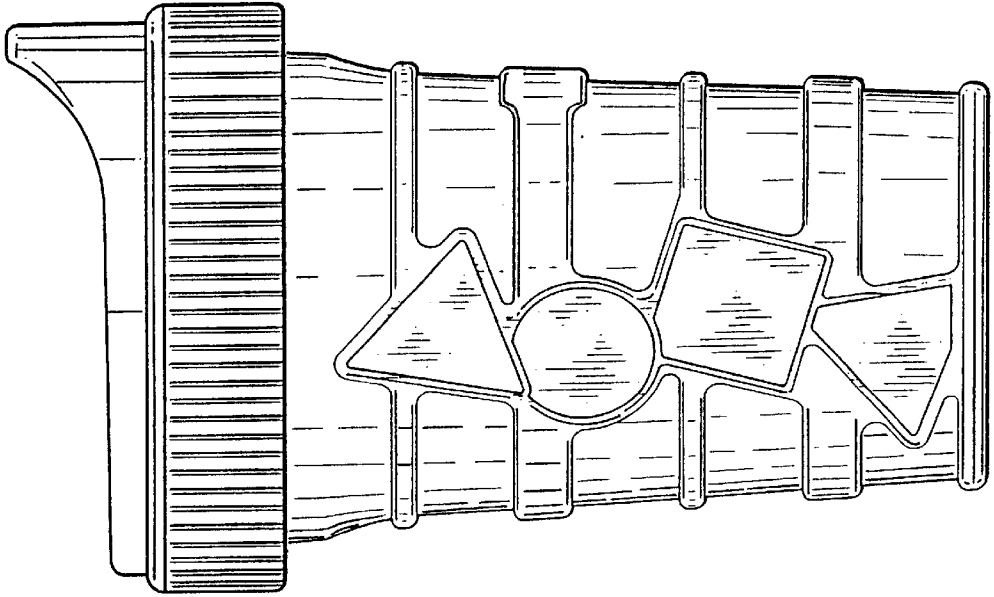
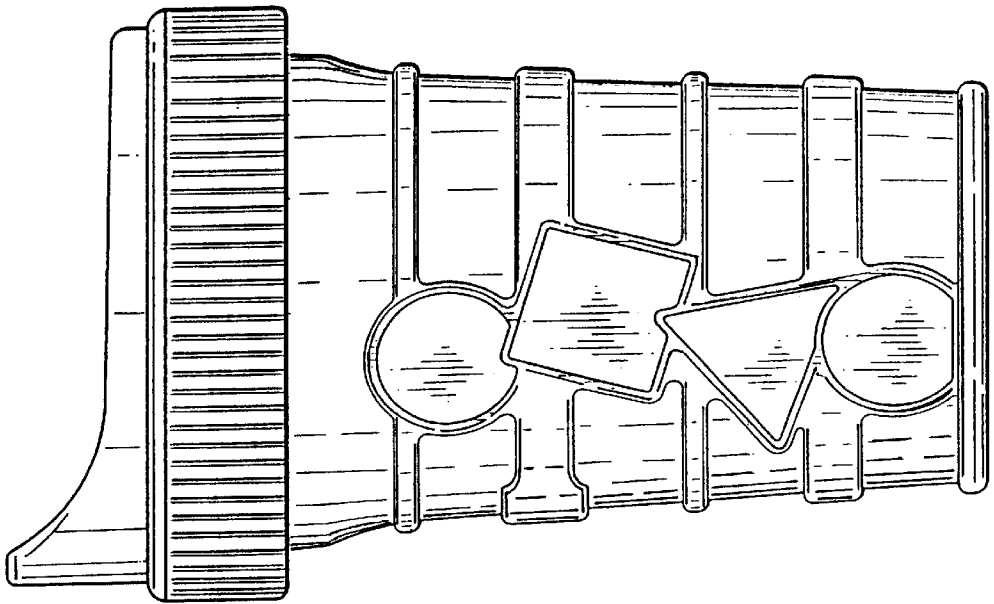
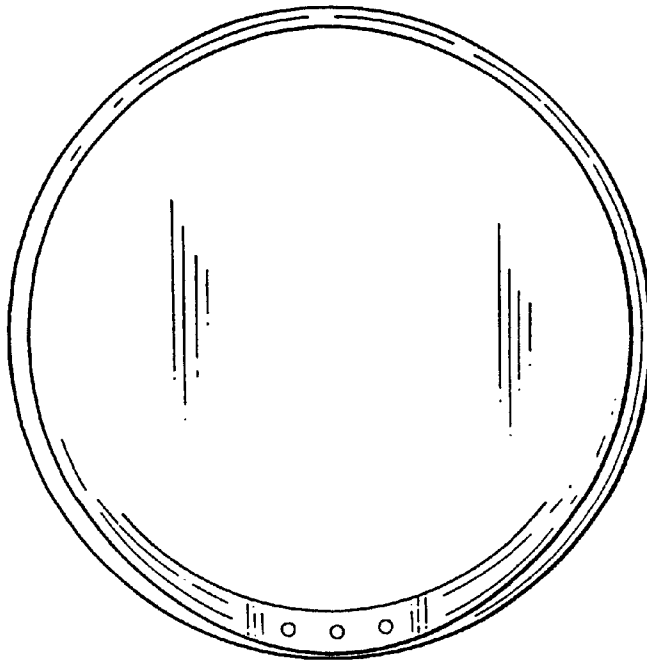

FIG. 4



**FIG. 6**



**FIG. 7**

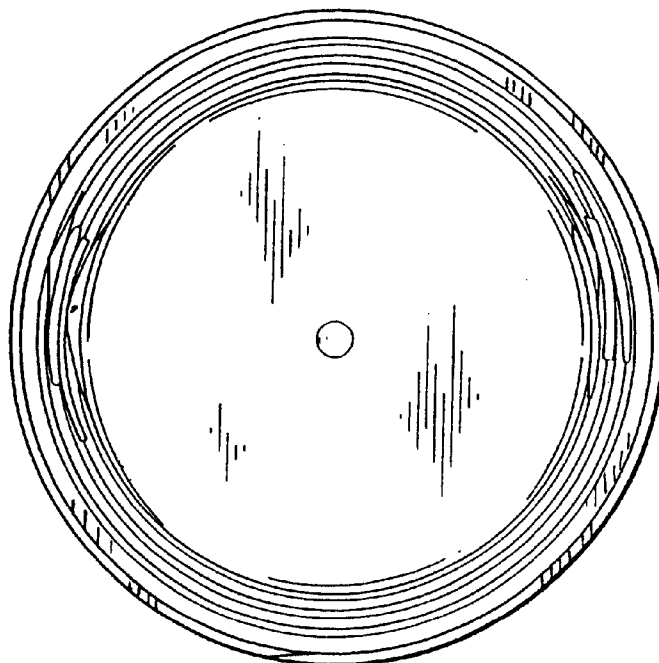

*FIG. 8*

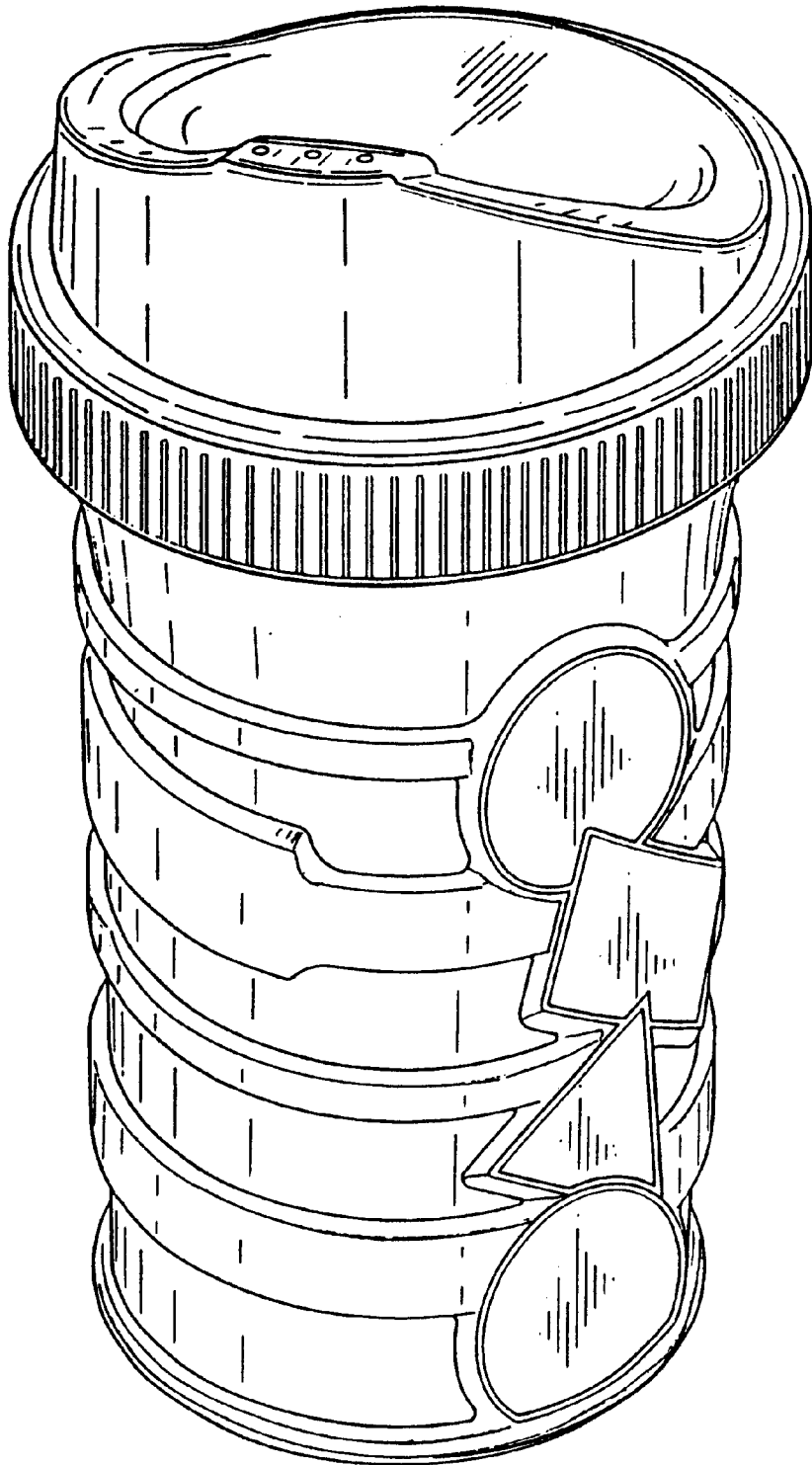



FIG. 10

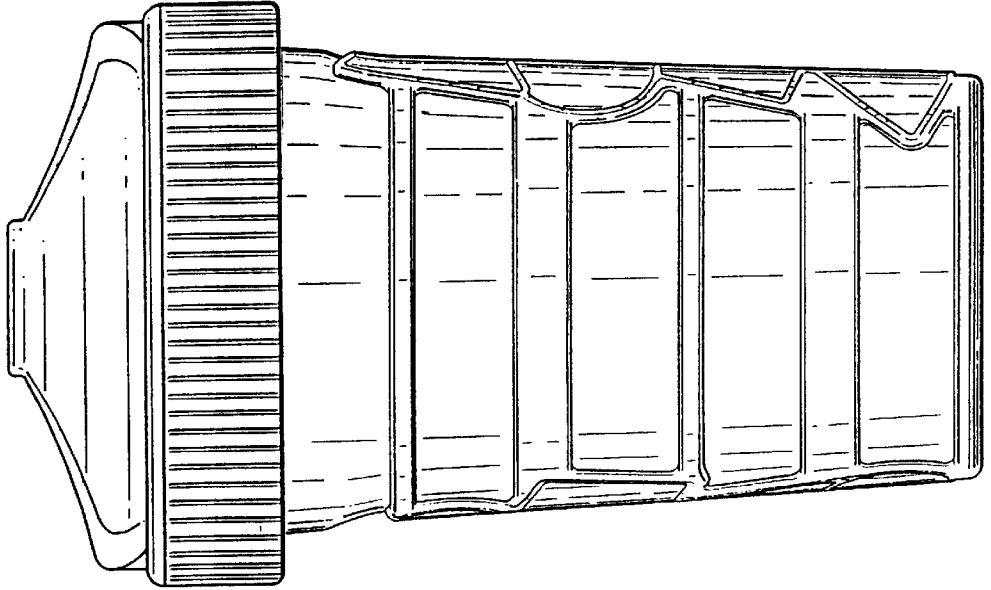

FIG. 9

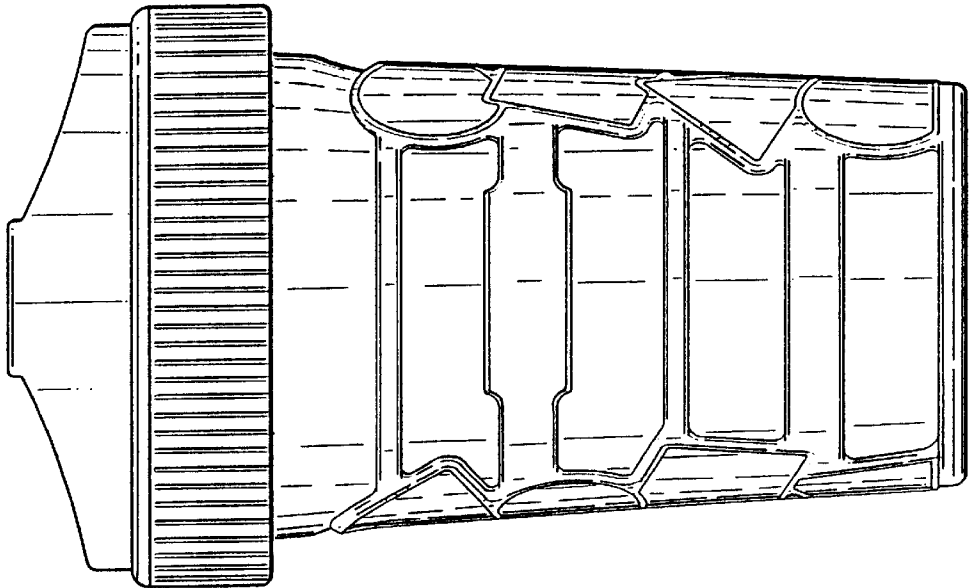

FIG. 12

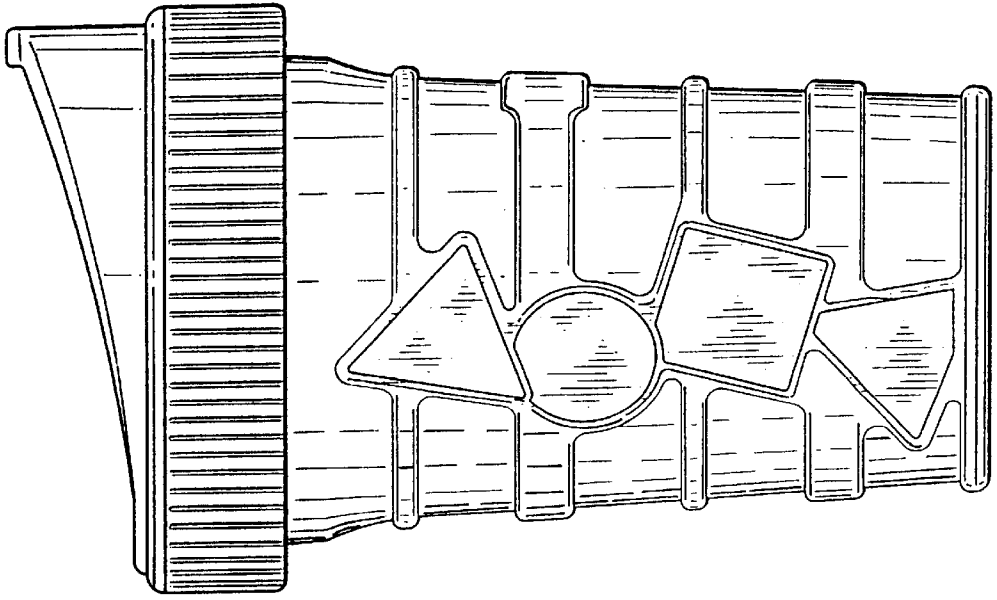
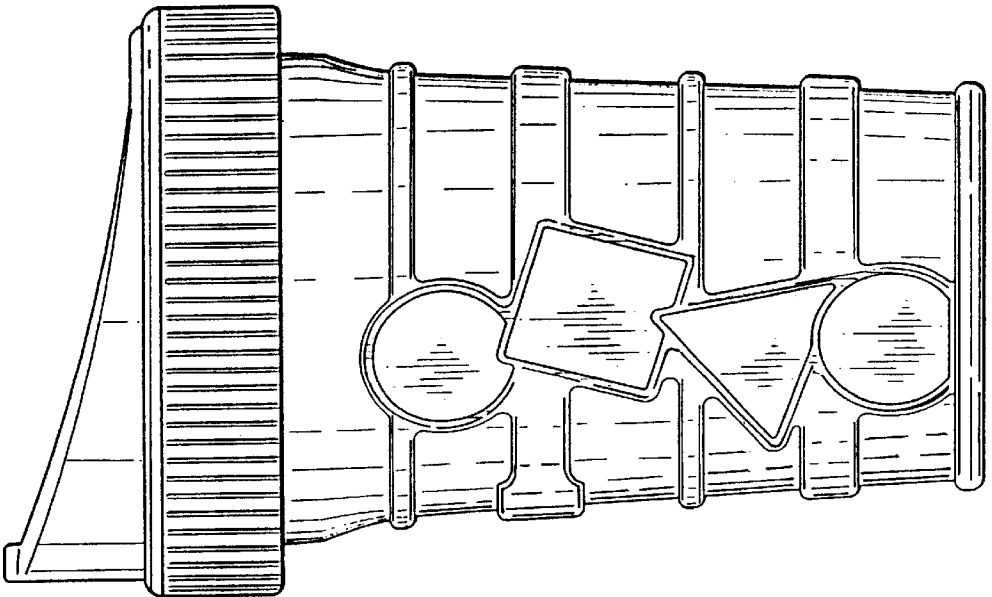
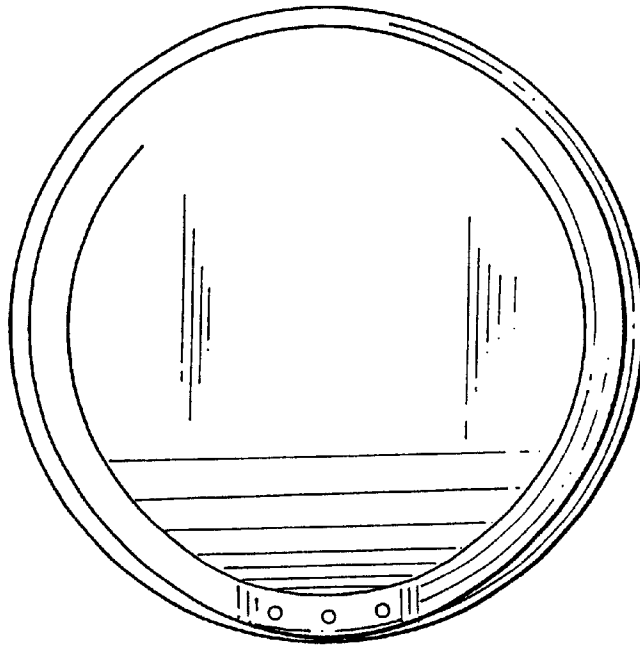

FIG. 11



*FIG. 13*



*FIG. 14*

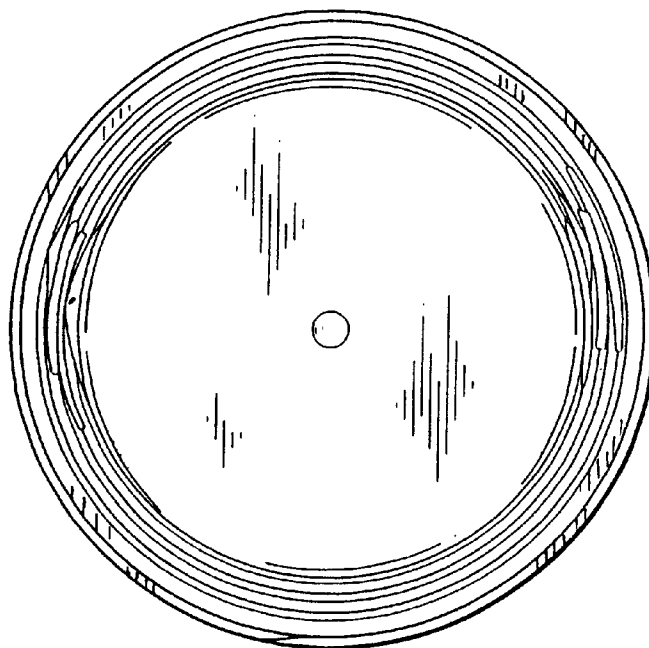

*FIG. 15*

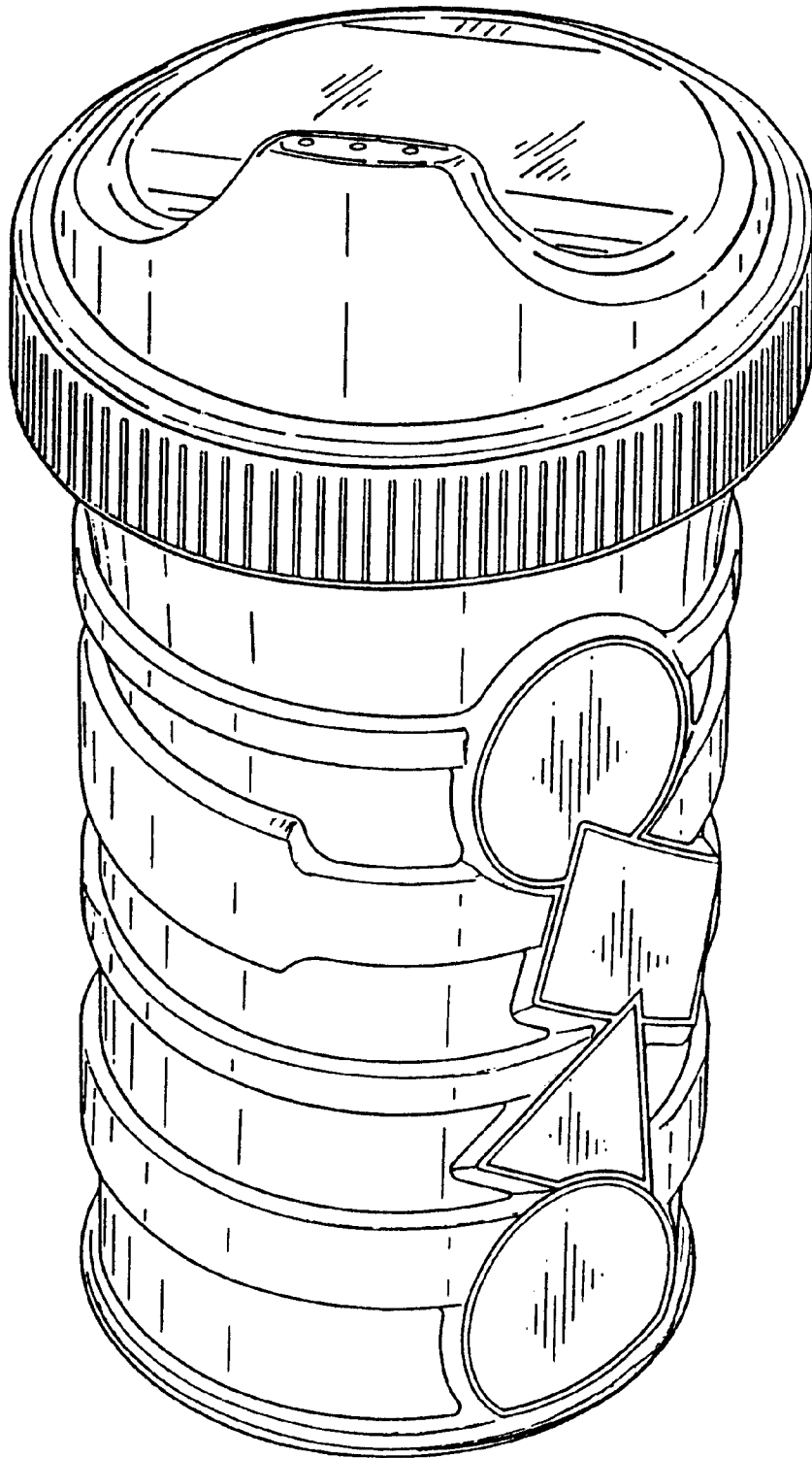

FIG. 17

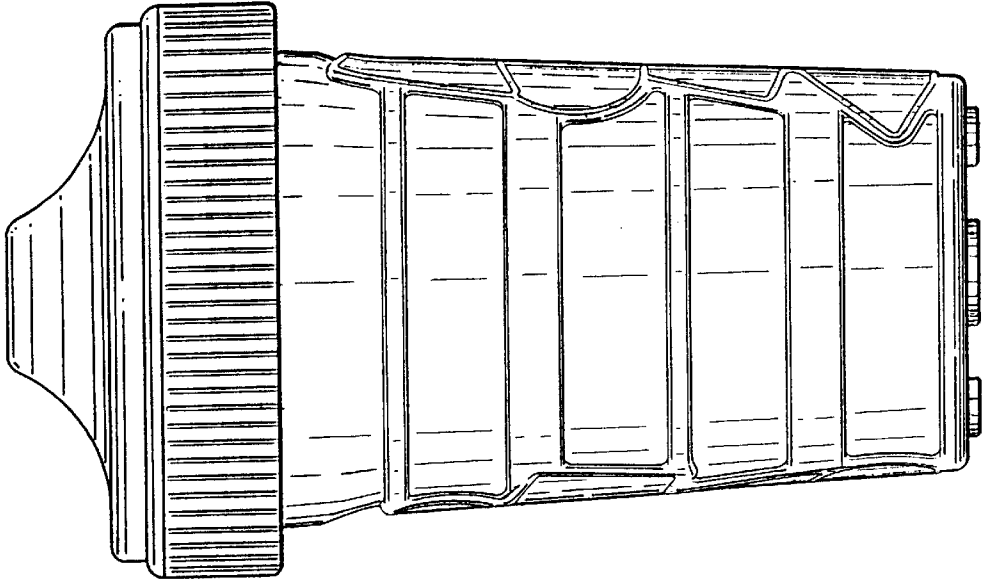

FIG. 16

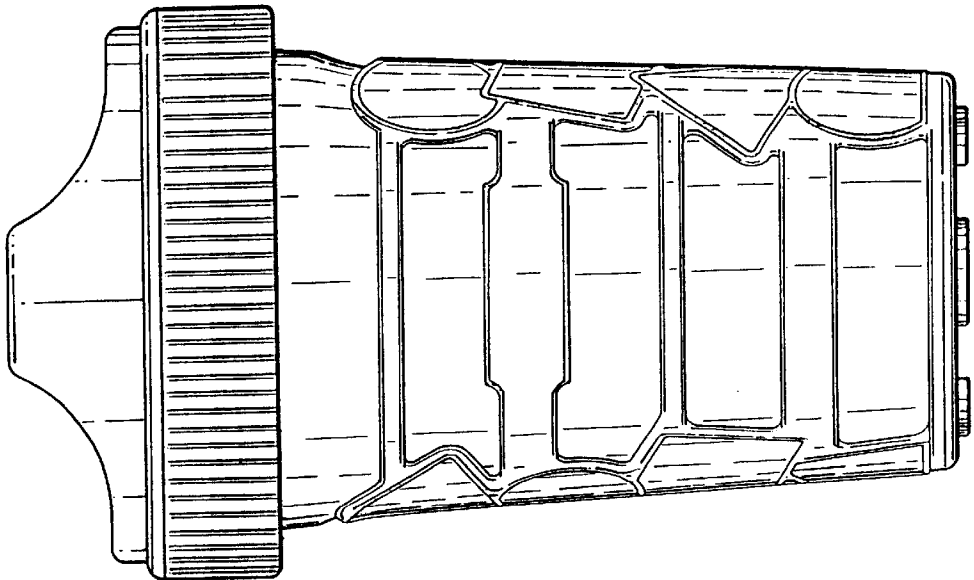

FIG. 19

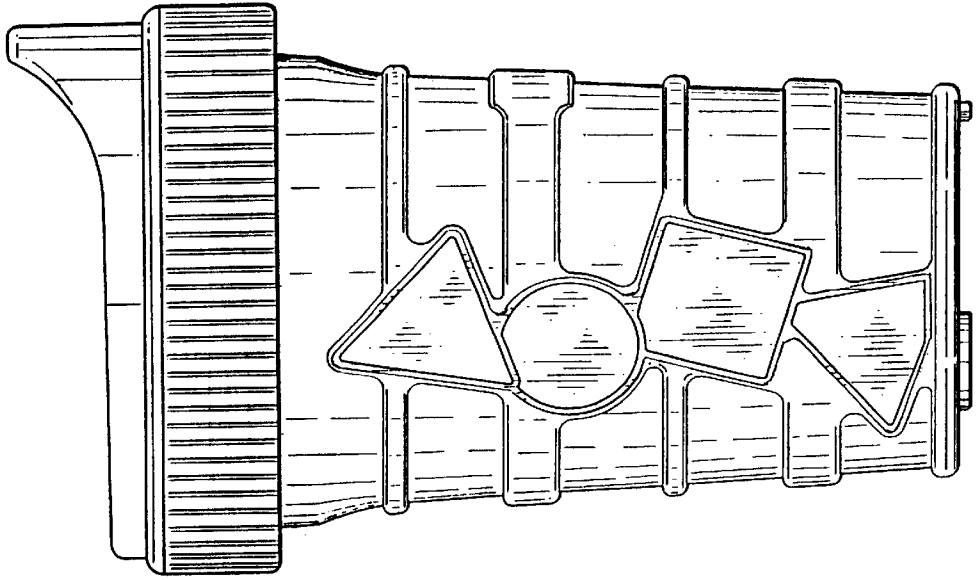
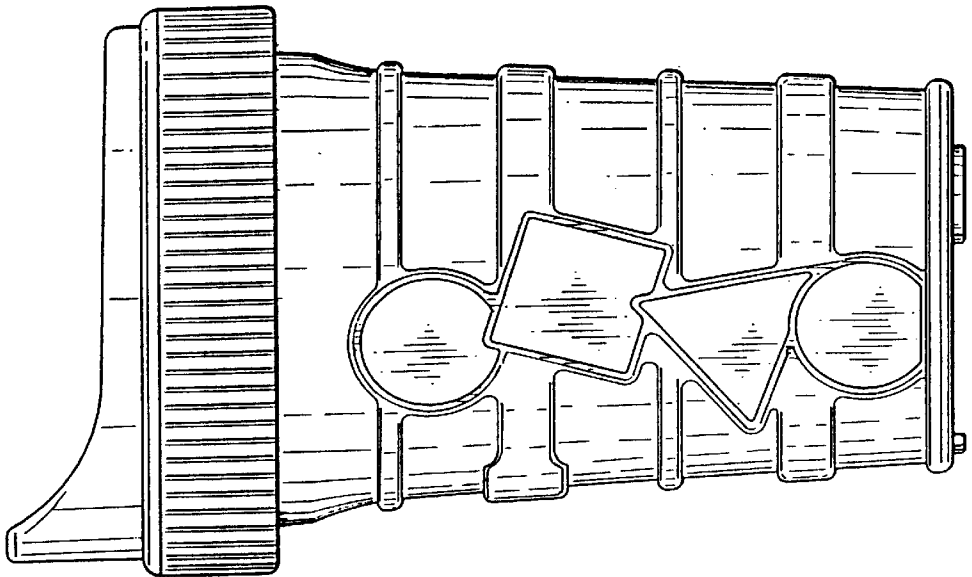
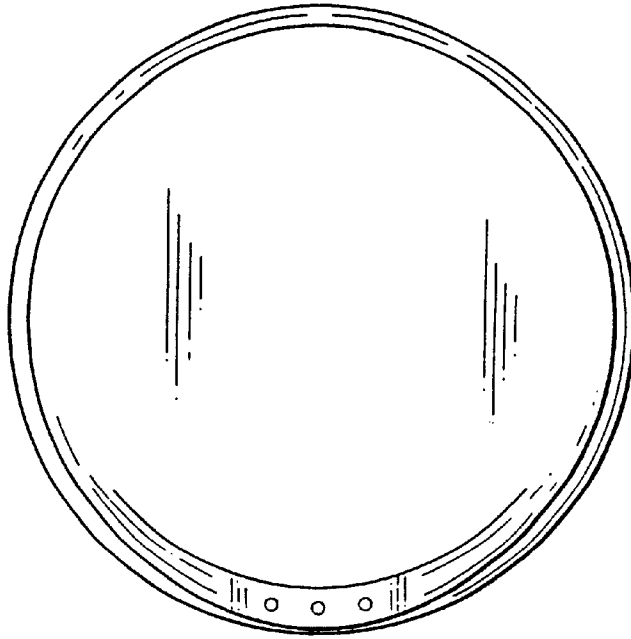

FIG. 18



*FIG. 20*



*FIG. 21*

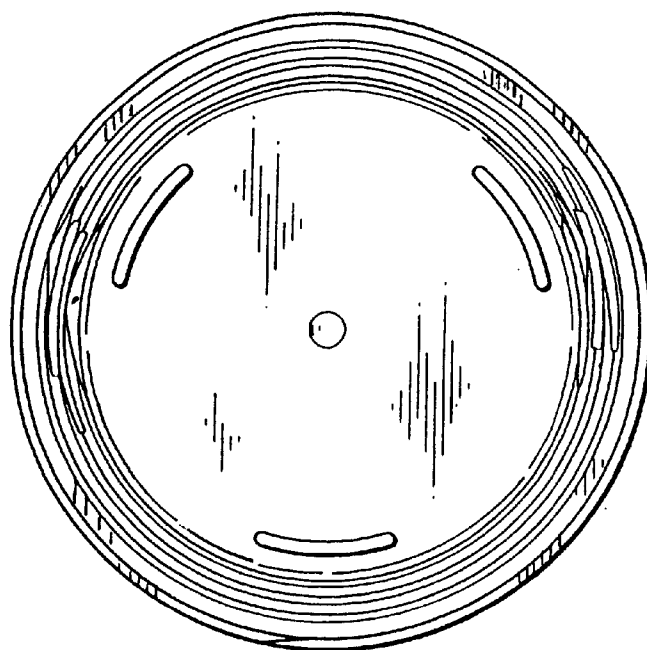

**FIG. 22**

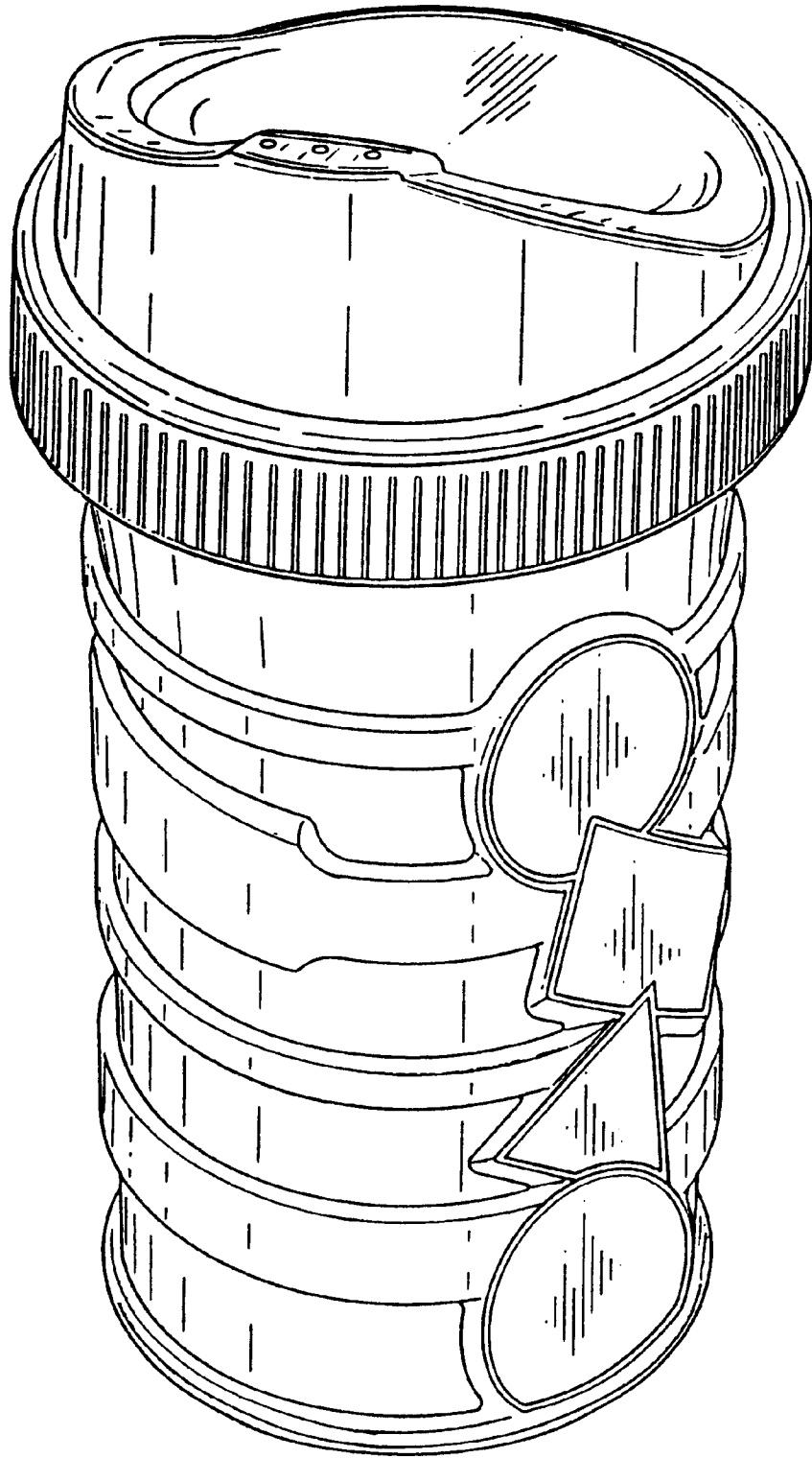



FIG. 24

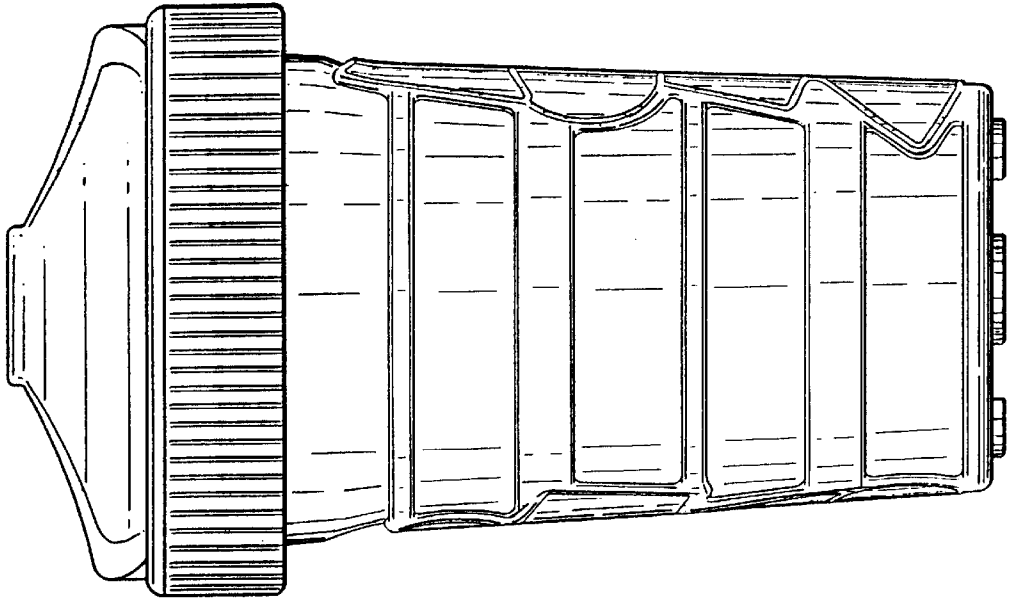

FIG. 23

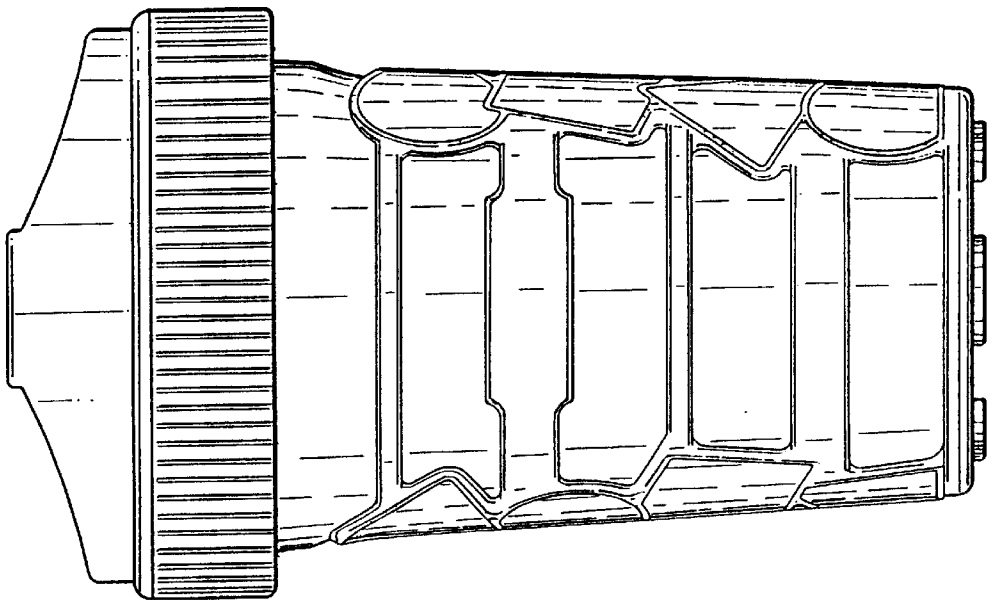

FIG. 26

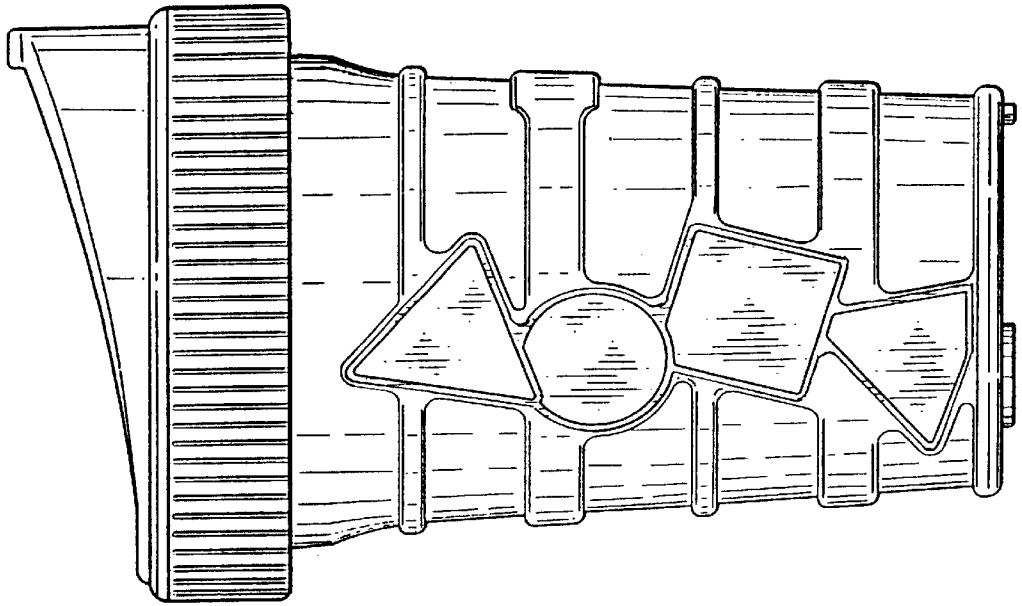
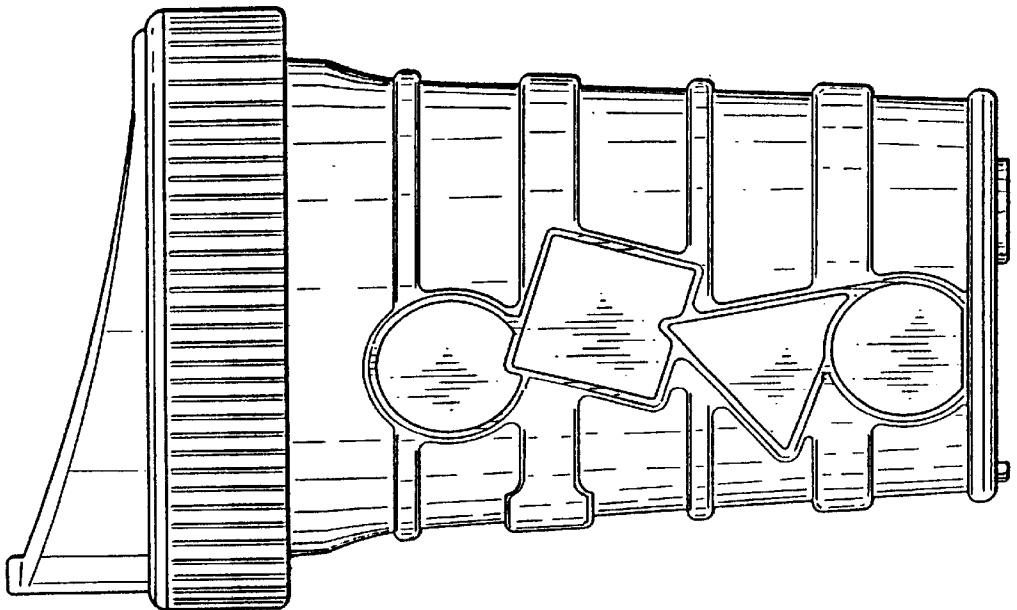
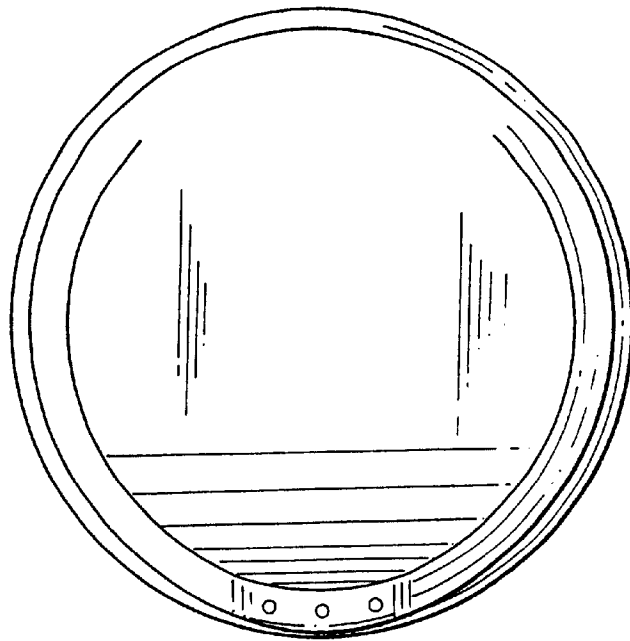

FIG. 25



*FIG. 27*



*FIG. 28*

