



US00D544230S

(12) **United States Design Patent** (10) **Patent No.:** **US D544,230 S**  
**Glass et al.** (45) **Date of Patent:** **\*\* Jun. 12, 2007**

(54) **CHAIR**

(75) Inventors: **Peter Glass**, Arroyo Grande, CA (US);  
**Robert J. Mills**, Torrance, CA (US)

(73) Assignee: **Virco Mgmt. Corporation**, Torrance,  
CA (US)

(\*\*) Term: **14 Years**

(21) Appl. No.: **29/243,069**

(22) Filed: **Nov. 17, 2005**

(51) **LOC (8) Cl.** ..... **06-01**

(52) **U.S. Cl.** ..... **D6/375**

(58) **Field of Classification Search** ..... D6/334-336,  
D6/338, 366, 367, 371-374, 375, 376, 379,  
D6/380, 499, 500-502; 297/DIG. 2, 445.1,  
297/447.1, 447.2, 452.12, 452.19

See application file for complete search history.

(56) **References Cited**

**U.S. PATENT DOCUMENTS**

D150,683 S	8/1948	Eames	
D150,685 S	8/1948	Eames	
D155,272 S	9/1949	Eames	
D155,273 S	9/1949	Eames	
D155,274 S	9/1949	Eames	
D169,930 S	6/1953	Chapman et al.	
D169,931 S	6/1953	Chapman et al.	
D171,116 S	12/1953	Adkinson	
D181,241 S	10/1957	Swanson	
D186,103 S	9/1959	Junkune	
D195,620 S	7/1963	Chapman et al.	
D202,548 S *	10/1965	Kramer	D6/375
D202,549 S *	10/1965	Kramer	D6/375
D202,550 S *	10/1965	Kramer	D6/375
3,276,818 A	10/1966	Durfee et al.	
4,002,369 A	1/1977	Jennings	
5,154,474 A	10/1992	Desanta	
D360,083 S *	7/1995	Lohmeyer	D6/375

D388,629 S	1/1998	Piretti	
D470,320 S *	2/2003	Schloss	D6/375
D471,729 S *	3/2003	Glass et al.	D6/375
D471,730 S	3/2003	Schloss	
D473,407 S *	4/2003	Ross	D6/500
D499,260 S *	12/2004	Glass et al.	D6/375
D507,893 S *	8/2005	Glass et al.	D6/360
D513,911 S *	1/2006	Glass et al.	D6/502
D514,339 S *	2/2006	Glass et al.	D6/366
D526,134 S *	8/2006	Glass et al.	D6/375

**OTHER PUBLICATIONS**

2 Photos of Artco-Bell Chairs, Jan. 2005.  
Internet Advertisement for desk and chair combination, publication date unknown, but at least as early as Jun. 14, 2005.  
From Artco-Bell Web site, date unknown, but at least as early as Jun. 20, 2005.  
Internet Advertisement: New Product Introductions, NeoCon, Chicago, 2005.

(Continued)

*Primary Examiner*—Mimosa De  
(74) *Attorney, Agent, or Firm*—Sheldon & Mak; Denton L. Anderson; Robert M. Hupe

(57) **CLAIM**

The ornamental design for a chair, as shown and described.

**DESCRIPTION**

FIG. 1 is a perspective view of the chair of the invention;  
FIG. 2 is a front view of the chair illustrated in FIG. 1;  
FIG. 3 is a left side view and the mirror image of the right side view of the chair illustrated in FIG. 1;  
FIG. 4 is a top view of the chair illustrated in FIG. 1;  
FIG. 5 is a bottom view of the chair illustrated in FIG. 1; and,  
FIG. 6 is a rear view of the chair illustrated in FIG. 1.

**1 Claim, 4 Drawing Sheets**

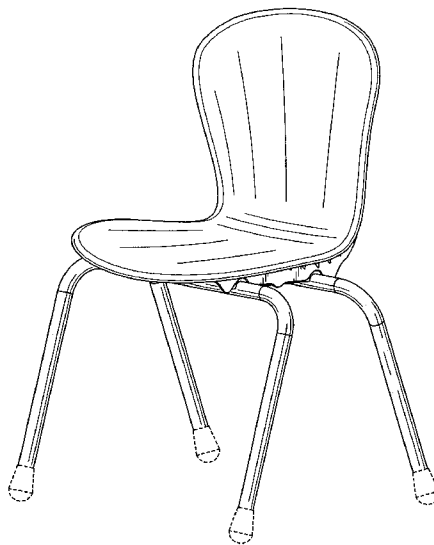

# US D544,230 S

Page 2

---

## OTHER PUBLICATIONS

Internet Advertisement: NeoCon World's Trade Fair 2005, Jun. 13-15, 2005.

Internet Advertisement: NeoCon World's Trade Fair Interior Design Show Daily Internet date Jun. 16, 2005.

Internet Advertisement: ERG International—Office and Contract Furniture, Internet date Jun. 16, 2005.

Internet Advertisement: Versteel—Chela, publication date unknown internet date Jun. 16, 2005.

Internet Advertisement: Bernhardt Design, publication date unknown.

Internet Advertisement: Gauss-Chair.com, publication date unknown internet date Jun. 16, 2005.

\* cited by examiner

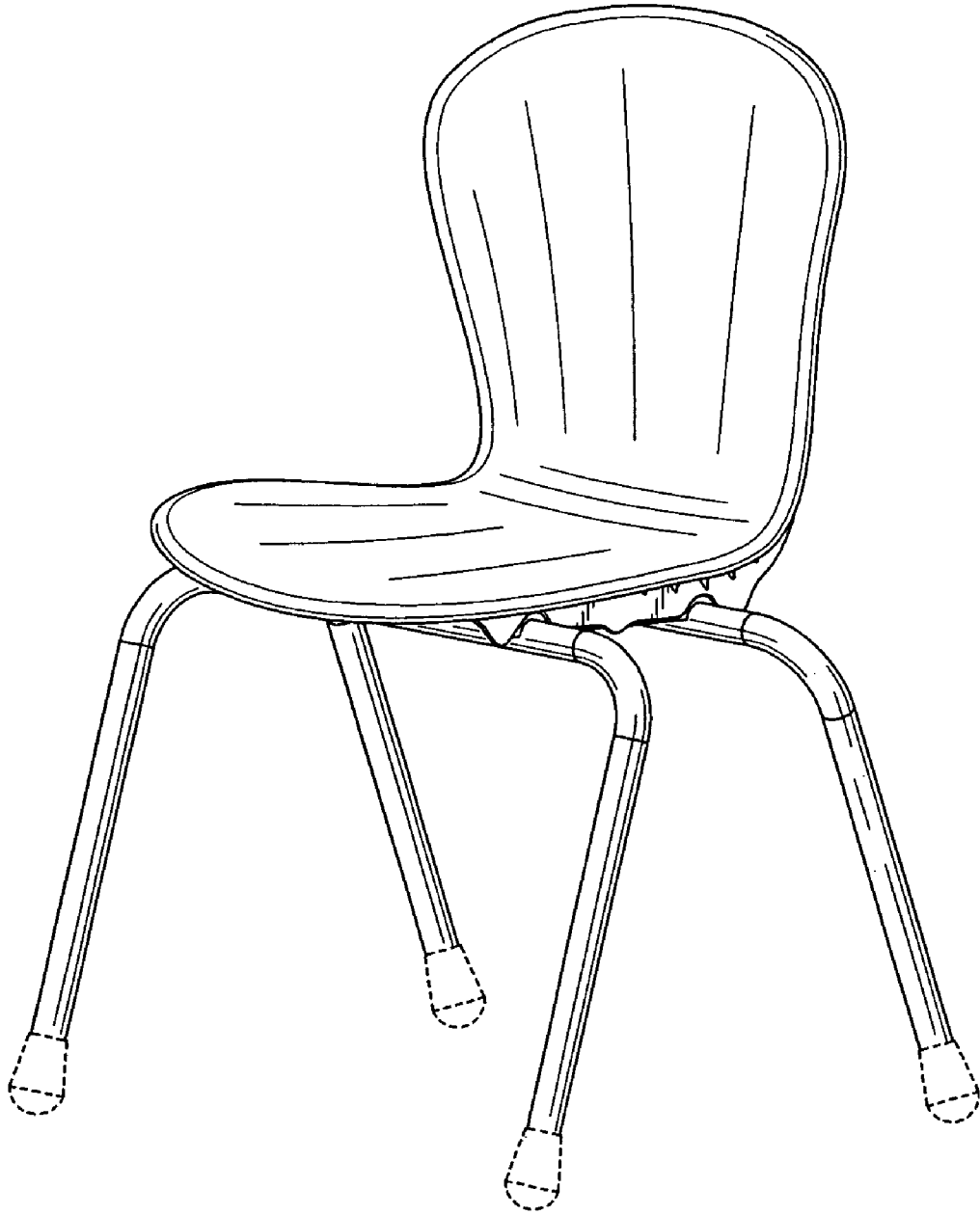

*FIG. 1*

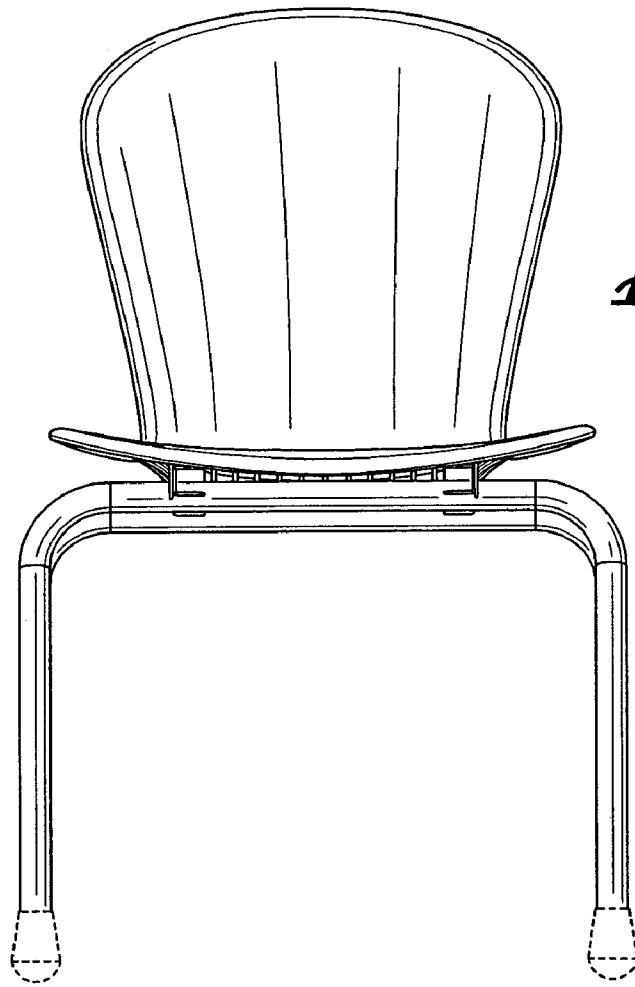

*FIG. 2*

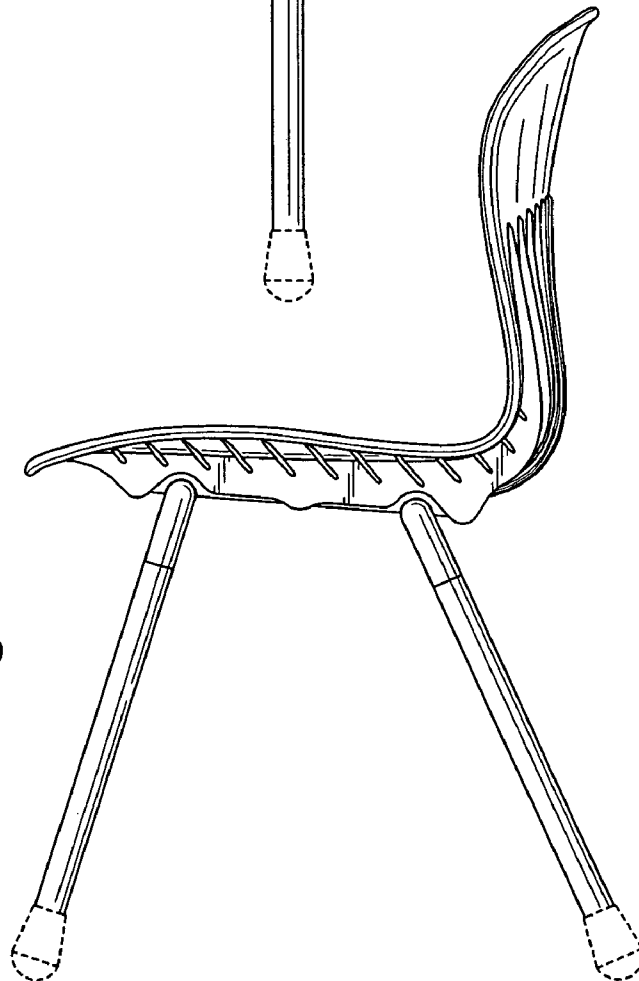

*FIG. 3*

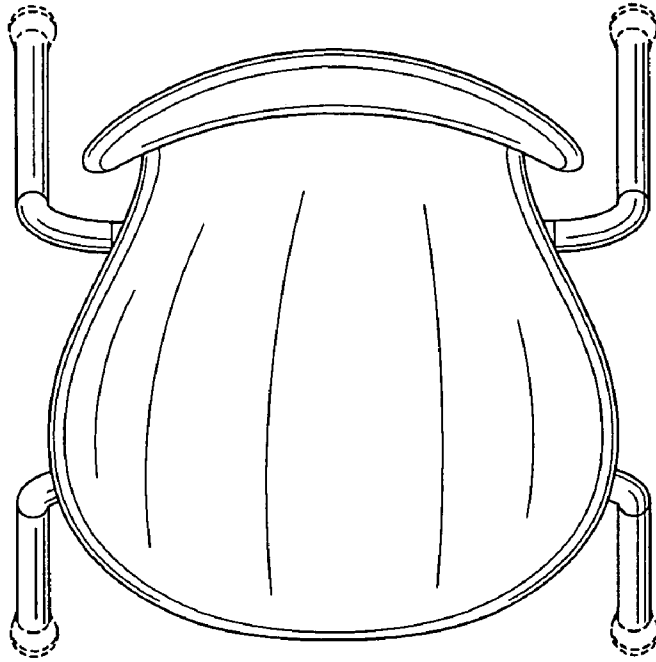

*FIG. 4*

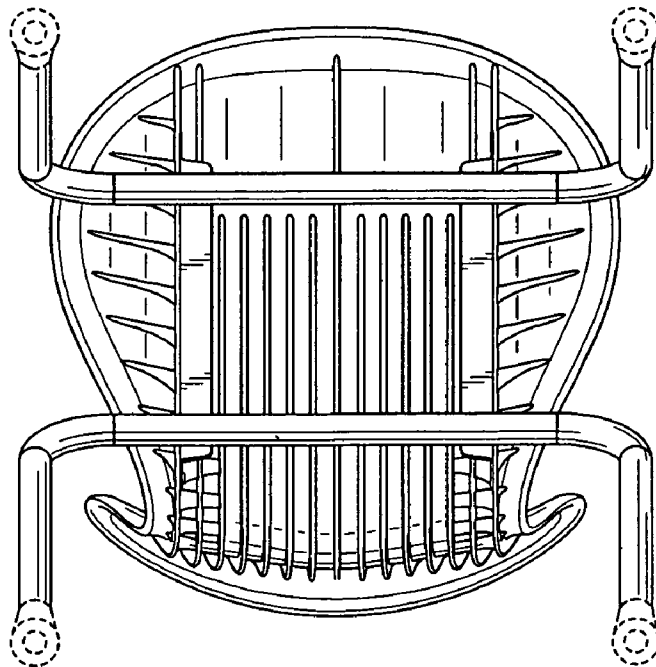

*FIG. 5*

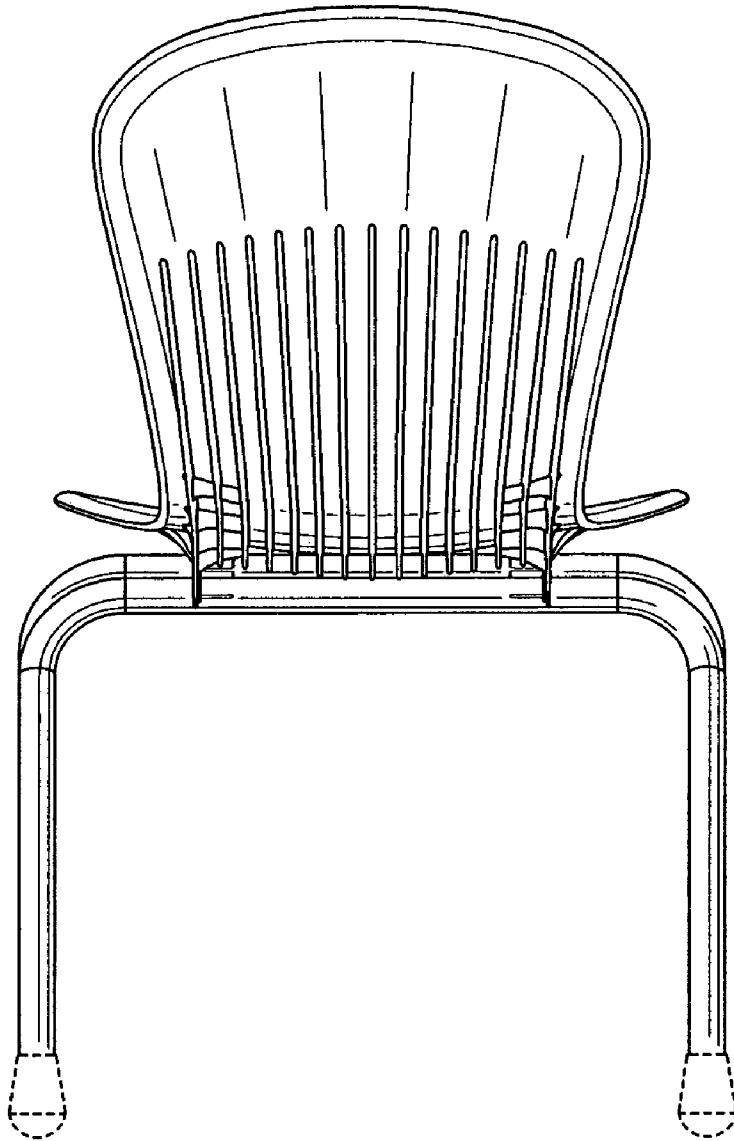

*FIG. 6*