



- (51) International Patent Classification:
H04N 7/32 (2006.01) *H04N 7/26* (2006.01)
- (21) International Application Number:
PCT/CN2012/079165
- (22) International Filing Date:
26 July 2012 (26.07.2012)
- (25) Filing Language: English
- (26) Publication Language: English
- (30) Priority Data:

61/524,686	17 August 2011 (17.08.2011)	US
61/556,526	7 November 2011 (07.11.2011)	US
61/564,696	29 November 2011 (29.11.2011)	US
61/583,830	6 January 2012 (06.01.2012)	US
61/613,743	21 March 2012 (21.03.2012)	US

(81) Designated States (unless otherwise indicated, for every kind of national protection available): AE, AG, AL, AM, AO, AT, AU, AZ, BA, BB, BG, BH, BN, BR, BW, BY, BZ, CA, CH, CL, CN, CO, CR, CU, CZ, DE, DK, DM, DO, DZ, EC, EE, EG, ES, FI, GB, GD, GE, GH, GM, GT, HN, HR, HU, ID, IL, IN, IS, JP, KE, KG, KM, KN, KP, KR, KZ, LA, LC, LK, LR, LS, LT, LU, LY, MA, MD, ME, MG, MK, MN, MW, MX, MY, MZ, NA, NG, NI, NO, NZ, OM, PE, PG, PH, PL, PT, QA, RO, RS, RU, RW, SC, SD, SE, SG, SK, SL, SM, ST, SV, SY, TH, TJ, TM, TN, TR, TT, TZ, UA, UG, US, UZ, VC, VN, ZA, ZM, ZW.

(84) Designated States (unless otherwise indicated, for every kind of regional protection available): ARIPO (BW, GH, GM, KE, LR, LS, MW, MZ, NA, RW, SD, SL, SZ, TZ, UG, ZM, ZW), Eurasian (AM, AZ, BY, KG, KZ, RU, TJ, TM), European (AL, AT, BE, BG, CH, CY, CZ, DE, DK, EE, ES, FI, FR, GB, GR, HR, HU, IE, IS, IT, LT, LU, LV, MC, MK, MT, NL, NO, PL, PT, RO, RS, SE, SI, SK, SM, TR), OAPI (BF, BJ, CF, CG, CI, CM, GA, GN, GQ, GW, ML, MR, NE, SN, TD, TG).

- (71) Applicant (for all designated States except US): **MEDIA-TEK SINGAPORE PTE. LTD.** [SG/SG]; No. 1 Fusionopolis Walk, #03-01 Solaris, Singapore 138628 (SG).
- (72) Inventors; and
- (75) Inventors/Applicants (for US only): **LIU, Shan** [US/US]; 1318 Vierra Ct, San Jose, California 95125 (US). **ZHANG, Xi-Min** [US/US]; 1477 Crespi Drive, San Jose, California 95129 (US). **LEI, Shaw-Min** [CN/CN]; 6F., No. 32 Liujia 6th St., Zhubei City, Hsinchu County, Taiwan 302 (CN).
- (74) Agent: **BEIJING SANYOU INTELLECTUAL PROPERTY AGENCY LTD.**; 16th Fl., Block A, Corporate Square, No. 35 Jinrong Street, Beijing 100033 (CN).

Declarations under Rule 4.17:

- as to the applicant's entitlement to claim the priority of the earlier application (Rule 4.17(iii))

Published:

- with international search report (Art. 21(3))

(54) Title: METHOD AND APPARATUS FOR INTRA PREDICTION USING NON-SQUARE BLOCKS

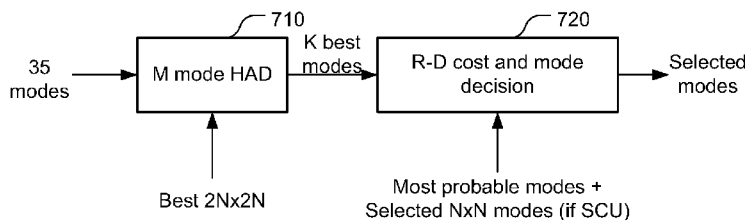

Fig.7

(57) Abstract: A method and apparatus for Intra prediction of a block based on neighboring pixels around the block are disclosed. Embodiments according to the present invention use square blocks as well as non-square blocks for Intra prediction. For a 2Nx2N Luma CU (coding unit), the CU can be partitioned into 2NxN, Nx2N, 2Nx2N or NxN PUs. The 2NxN and Nx2N PUs can be further processed by either square transforms only or both non-square and square transforms. In one embodiment, the 2NxN PU or the Nx2N PU is processed as two NxN TUs (transform units) and each of the NxN TU is further split into smaller NxN TUs based on quad-tree split. In another embodiment, the 2NxN and Nx2N PUs are processed as two 2Nx0.5N and 0.5Nx2N TUs respectively.

WO 2013/023518 A1

METHOD AND APPARATUS FOR INTRA PREDICTION USING NON-SQUARE BLOCKS

CROSS REFERENCE TO RELATED APPLICATIONS

The present invention claims priority to U.S. Provisional Patent Application, Serial No. 61/524,686, filed August 17, 2011, entitled "Method and apparatus of Intra prediction and mode coding for video compression", U.S. Provisional Patent Application, Serial No. 61/556,526 filed November 4, 2011, entitled "Method and apparatus of rectangular Intra prediction for video compression", U.S. Provisional Patent Application, Serial No. 61/ 564,696, filed November 29, 2011, entitled "Method for signaling multiple prediction units in an Intra coding unit in HEVC", U.S. Provisional Patent Application, Serial No. 61/ 583,830, filed January 6, 2012, entitled "System and methods of coding non-square Intra prediction unit for video compression" and U.S. Provisional Patent Application, Serial No. 61/ 613,743, filed March 21, 2012, entitled "Method and apparatus of rectangular Intra prediction in HEVC". The U.S. Provisional Patent Applications are hereby incorporated by reference in their entireties.

TECHNICAL FIELD

The present invention relates to video coding. In particular, the present invention relates to Intra coding techniques associated with partition of prediction units and coding units using non-square blocks.

BACKGROUND

Motion compensated inter-frame coding has been widely adopted in various coding standards, such as MPEG-1/2/4 and H.261/H.263/H.264/AVC. While motion-compensated inter-frame coding can effectively reduce bitrate for compressed video, Intra mode coding is still required to process an initial picture or to periodically insert I-pictures (or Intra-coded picture, I-picture), and the I-pictures are inserted periodically to allow quick access to the compressed video data or to alleviate error propagation. Intra prediction exploits the spatial correlation within a picture or within a picture region. In order to further improve coding efficiency, the High-Efficiency Video Coding (HEVC) standard being developed exploits block-based spatial prediction extensively. In

HEVC, multiple Intra prediction modes are used to exploit spatial features.

In AVC, the size of a prediction unit (or block) that is coded using Intra prediction can be 4x4, 8x8 or 16x16. There are nine Intra prediction modes for Luma blocks at 4x4 and 8x8, as shown in Table 1 and Table 2 respectively. There are four Intra prediction modes for Luma 16x16 blocks, as shown in Table 3 and there are four Intra prediction modes for Chroma blocks, as shown in Table 4. The AVC intra prediction directions are shown in Fig. 1.

Table 1

Intra4x4PredMode [luma4x4BlkIdx]	Name of Intra4x4PredMode[luma4x4BlkIdx]
0	Intra_4x4_Vertical (prediction mode)
1	Intra_4x4_Horizontal (prediction mode)
2	Intra_4x4_DC (prediction mode)
3	Intra_4x4_Diagonal_Down_Left (prediction mode)
4	Intra_4x4_Diagonal_Down_Right (prediction mode)
5	Intra_4x4_Vertical_Right (prediction mode)
6	Intra_4x4_Horizontal_Down (prediction mode)
7	Intra_4x4_Vertical_Left (prediction mode)
8	Intra_4x4_Horizontal_Up (prediction mode)

Table 2

Intra8x8PredMode [luma8x8BlkIdx]	Name of Intra8x8PredMode[luma8x8BlkIdx]
0	Intra_8x8_Vertical (prediction mode)
1	Intra_8x8_Horizontal (prediction mode)
2	Intra_8x8_DC (prediction mode)
3	Intra_8x8_Diagonal_Down_Left (prediction mode)
4	Intra_8x8_Diagonal_Down_Right (prediction mode)
5	Intra_8x8_Vertical_Right (prediction mode)
6	Intra_8x8_Horizontal_Down (prediction mode)
7	Intra_8x8_Vertical_Left (prediction mode)
8	Intra_8x8_Horizontal_Up (prediction mode)

Table 3

Intra16x16PredMode	Name of Intra16x16PredMode
0	Intra_16x16_Vertical (prediction mode)
1	Intra_16x16_Horizontal (prediction mode)
2	Intra_16x16_DC (prediction mode)
3	Intra_16x16_Plane (prediction mode)

Table 4

intra_chroma_pred_mode	Name of Intra Chroma Prediction Mode
0	Intra_Chroma_DC (prediction mode)
1	Intra_Chroma_Horizontal (prediction mode)
2	Intra_Chroma_Vertical (prediction mode)
3	Intra_Chroma_Plane (prediction mode)

In HEVC, each picture is divided into a set of square coding units (CUs). Each coding unit may be further divided into multiple prediction units (PUs). In the HEVC Committee Draft (CD) and Test Model Version 6.0 (HM-6.0), a 2Nx2N CU may include PUs with partition sizes 2Nx2N and NxN for an Intra coded frame or slice as shown in Fig. 2A. A 2Nx2N CU may include PUs with partition sizes 2Nx2N, Nx2N, 2NxN and NxN for an Inter coded frame or slice as shown in Fig. 2B. Note that the NxN prediction type may only exist in smallest coding units (SCU) for both Intra and Inter cases.

In HM-6.0, the prediction and partition modes and the binarization are defined in Table 5, where **PredMode** refers to the prediction mode (Intra or Inter), **part_mode** refers to the partition mode, **cLog2CUSize** is associated with the current CU size, **Log2MinCUSize** is associated with the minimum CU size, and **inter_4x4_enabled_flag** refers to a flag for indicating whether Inter 4x4 mode is enabled.

Table 5

PredMode	Value of part_mode	PartMode	Bin string	
			cLog2CUSize = = Log2MinCUSize	cLog2CUSize > Log2MinCUSize
			cLog2CUSize = = Log2MinCUSize	cLog2CUSize > 3
			cLog2CUSize = 3 && !inter_4x4_enabled_flag	 inter_4x4_enabled_flag

MODE_INT RA	0	PART_2Nx2N	-	1	1
	1	PART_NxN	-	0	0
MODE_INTE R	0	PART_2Nx2N	1	1	1
	1	PART_2NxN	011	01	01
	2	PART_Nx2N	001	00	001
	3	PART_NxN	-	-	000
	4	PART_2NxN	0100	-	-
	5	PART_2NxN	0101	-	-
	6	PART_nLx2N	0000	-	-
7	PART_nRx2N	0001	-	-	

In HM-6.0 common test conditions, the Luma CU size can be 64x64, 32x32, 16x16 and 8x8. The smallest CU can be further split into four prediction units (PUs) such that if, for example, the smallest CU size is 8x8, the PU can be split into four 4x4 square PUs. Therefore, the Luma Intra prediction unit size can be 64x64, 32x32, 16x16, 8x8 and 4x4. In HM-6.0, 35 Intra prediction modes (as shown in Fig. 3A) are allowed for all Luma PU sizes and 6 modes are allowed for Intra Chroma predictions. It is desired to improve the coding efficiency of Intra prediction by including non-square prediction modes and exploring associated non-square transforms.

SUMMARY

A method and apparatus for Intra prediction of a block based on neighboring pixels around the block are disclosed. In one embodiment according to the present invention, the method and apparatus for Intra prediction of a block based on neighboring pixels around the block comprises receiving a Luma block corresponding to Luma pixels of the block; and performing Intra prediction for the Luma block based on neighboring Luma pixels, wherein the Luma block is partitioned into one or more PUs (prediction units) having a shape from a group consisting of a square shape and a non-square shape. For a 2Nx2N Luma CU (coding unit), the CU can be partitioned into 2NxN, Nx2N, 2Nx2N or NxN PUs. Furthermore, the partition modes associated with the PUs are indicated using a codeword table for the Luma block in Intra and Inter slices, wherein the codeword table includes entries for the 2NxN and Nx2N PUs. The 2NxN and Nx2N PUs can be further processed by either square transforms only or both non-square and square transforms.

When the 2NxN and Nx2N PUs are processed by square transforms only or both non-square and square transforms, three embodiments according to the present invention are disclosed. In the first embodiment, the 2NxN PU or the Nx2N PU is processed as two NxN TUs (transform units)

and each of the $N \times N$ TU is further split into smaller $N \times N$ TUs based on quad-tree split if the $N \times N$ TU is larger than a smallest size. The smaller $N \times N$ TUs associated with the $2N \times N$ PU or the $N \times 2N$ PU use a same Intra prediction mode as the $2N \times N$ PU or the $N \times 2N$ PU respectively. In this case, the smallest size is 4×4 . In the second embodiment, the $2N \times N$ and $N \times 2N$ PUs are processed as two $2N \times 0.5N$ and $0.5N \times 2N$ TUs respectively. The $2N \times 0.5N$ and $0.5N \times 2N$ TUs can be further split into smaller $2N \times 0.5N$ and $0.5N \times 2N$ TUs respectively based on quad-tree split if the $2N \times 0.5N$ and $0.5N \times 2N$ TUs are larger than a respective smallest size. In the third embodiment, the $2N \times N$ and $N \times 2N$ PUs are processed as two $2N \times 0.5N$ and $0.5N \times 2N$ TUs respectively if the $2N \times 2N$ Luma CU is larger than 8×8 , and the $2N \times N$ and $N \times 2N$ PUs are processed as two 4×4 TUs if the $2N \times 2N$ Luma CU has a size of 8×8 .

In another embodiment of the present invention, the method for Intra prediction further comprises receiving a Chroma block corresponding to Chroma pixels of the block; and performing Intra prediction for the Chroma block, wherein the Chroma block is partitioned into one or more Chroma PUs having the square shape only. The Chroma block corresponding to a $2N \times 2N$ CU is Intra predicted using $N \times N$ block size, wherein a candidate set of Chroma Intra prediction modes is derived for the Chroma block. An ordered mode set of Chroma Intra prediction modes consisting of {LM, DM0, DM1, Planar, Vertical, Horizontal, DC and Vertical+8} can be used to derive a candidate set for the Chroma Intra prediction modes, wherein DM0 and DM1 correspond to two DMs (direct modes) associated with two non-square PUs of a $2N \times 2N$ Luma CU respectively, and wherein first six different modes of the ordered mode set are selected as candidate modes for Chroma Intra prediction.

BRIEF DESCRIPTION OF DRAWINGS

Fig. 1 illustrates Intra prediction mode directions used by H.264/AVC.

Fig. 2A-B illustrate partition types for a $2N \times 2N$ coding unit in the Intra and Inter prediction modes of High Efficiency Video Coding (HEVC) respectively.

Fig. 3A illustrates Intra prediction mode directions used by High Efficiency Video Coding (HEVC), where each direction is indicated by an index.

Fig. 3B illustrates Intra prediction mode directions used by High Efficiency Video Coding (HEVC), where each direction is indicated by a reference with respect to the H or V direction.

Fig. 4A-B illustrate examples of applying square and non-square transforms to $2N \times N$ rectangular Intra prediction units according to an embodiment of the present invention.

Fig. 5A-B illustrate examples of applying square and non-square transforms to $N \times 2N$

rectangular Intra prediction units according to an embodiment of the present invention.

Fig. 6 illustrates an example of Intra prediction mode decision process according to an embodiment of the present invention.

Fig. 7 illustrates an example of fast encoder mode decision for the proposed scheme with non-square Intra prediction and partition according to an embodiment of the present invention.

DETAILED DESCRIPTION

In order to improve coding efficiency, embodiments according to the present invention utilize new Intra prediction partition structures, new syntax and new Intra prediction mode coding methods. CU (coding unit) partition for Intra prediction according to the present invention includes partition sizes $2N \times N$ and $N \times 2N$. Therefore, when the prediction mode of a CU is Intra, the prediction block size for a $2N \times 2N$ CU can be $2N \times 2N$, $2N \times N$ or $N \times 2N$ if it is larger than an SCU. Otherwise the prediction block size of this CU can be $2N \times 2N$, $2N \times N$, $N \times 2N$ or $N \times N$ if it is an SCU (smallest CU). The partition modes and binarization according to an embodiment of the present invention are illustrated in Table 6. The codes for partition modes associated with MODE_INTER stay the same as these in Table 5. The code assignment for partition modes of MODE_INTRA as shown in Table 6 illustrates an example to practice an embodiment of the present invention. The particular code assignment illustrated should not be construed as limitations to the present invention. A person skilled in the art may use other code assignments to practice the present invention.

Table 6

PredMode	Value of part_mode	PartMode	Bin string		
			cLog2CUSize > Log2MinCUSize	cLog2CUSize == Log2MinCUSize	
				cLog2CUSize = 3 && !inter_4x_4_enabled_flag	cLog2CUSize > 3 inter_4x_4_enabled_flag
MODE_INTRA	0	PART_2Nx2N	1	1	1
	1	PART_NxN	-	01	01
	2	PART_2NxN	01	001	001
	3	PART_Nx2N	00	000	000
MODE_INTER	0	PART_2Nx2N	1	1	1
	1	PART_2NxN	011	01	01
	2	PART_Nx2N	001	00	001

	3	PART_NxN	-	-	000
	4	PART_2NxN _U	0100	-	-
	5	PART_2NxN _D	0101	-	-
	6	PART_nLx2N	0000	-	-
	7	PART_nRx2N	0001	-	-

New Intra prediction modes (or mode sets) for the proposed 2NxN and Nx2N Intra partition types are used according to the present invention. In one embodiment, the prediction modes and directions for partition sizes 8x4, 4x8, 16x8, 8x16, 32x16 and 16x32 are illustrated in Table 7 and Table 8, and the direction naming is shown in Fig. 3B, where each direction is indicated by a reference with respect to the horizontal (H) or vertical (V) direction. Table 7 lists the Intra prediction modes for the 2NxN Intra PU, where 4 ≤ N ≤ 16. Table 8 lists the Intra prediction modes for the Nx2N Intra PU, where 4 ≤ N ≤ 16. For other 2NxN and Nx2N partition sizes, the four Intra prediction modes that are used for 64x64 in HEVC Test Model, i.e. Planar, DC, Vertical and Horizontal, are used.

Table 7

Index	0	1	2	3	4	5	6	7	8	9
Physical	Planar	V	H	DC	V-8	V-4	V+4	V+8	H-4	H+4
Index	10	11	12	13	14	15	16	17	18	19
Physical	H+8	V-6	V-2	V+2	V+6	H-6	H-2	H+2	H+6	V-7
Index	20	21	22	23	24	25				
Physical	V-5	V-3	V-1	V+1	V+3	V+5				

Table 8

Index	0	1	2	3	4	5	6	7	8	9
Physical	Planar	V	H	DC	V-8	V-4	V+4	V+8	H-4	H+4
Index	10	11	12	13	14	15	16	17	18	19
Physical	H+8	V-6	V-2	V+2	V+6	H-6	H-2	H+2	H+6	H-7
Index	20	21	22	23	24	25				
Physical	H-5	H-3	H-1	H+1	H+3	H+5				

In another embodiment, the prediction modes and directions for 4x2 and 2x4 Intra PUs are illustrated in Table 9 and Table 10, where the direction naming is shown in Fig. 3B. As shown in

Table 9 and Table 10, a total of 10 prediction modes are used for each of 4x2 Intra PUs and 2x4 Intra PUs. Accordingly, after the two MPMs (most probable modes) are removed from the 10 modes, the remaining 8 modes require only 3 bits to present, i.e. three bits for signaling each mode.

Table 9

Index	0	1	2	3	4	5	6	7	8	9
Physical	Planar	V	H	DC	V-8	V-4	V+4	V+8	V-2	V+2

5

Table 10

Index	0	1	2	3	4	5	6	7	8	9
Physical	Planar	V	H	DC	V-8	H-4	H+4	H+8	H-2	H+2

In another embodiment of the present invention, more prediction modes than the number of modes for a conventional HEVC system are used. When more prediction modes based on the neighboring CU or PU of the current Intra PU are allowed according to an embodiment of the present invention, a mapping table is needed to map those “out of range” modes to the allowed modes for the current CU or PU. For example, if the neighboring block is a 16x16 Intra CU or PU, there are 35 allowed prediction modes associated with this neighbor. If the current Intra PU is a 16x8 block, then only 27 modes are allowed according to an embodiment of the present invention. In other words, there are eight modes from the neighbor which are not allowed for the current PU. Therefore, eight modes need to be mapped to the modes that are allowed for the current PU. The 35 modes that are being used in current HEVC 2Nx2N Intra prediction (when $4 \leq N \leq 16$) is shown in Table 11.

Table 11

Index	0	1	2	3	4	5	6	7	8
Physical	Planar	V	H	DC	V-8	V-4	V+4	V+8	H-4
Index	9	10	11	12	13	14	15	16	17
Physical	H+4	H+8	V-6	V-2	V+2	V+6	H-6	H-2	H+2
Index	18	19	20	21	22	23	24	25	26
Physical	H+6	V-7	V-5	V-3	V-1	V+1	V+3	V+5	V+7
Index	27	28	29	30	31	32	33	34	
Physical	H-7	H-5	H-3	H-1	H+1	H+3	H+5	H+7	

In one embodiment, a 9x1 mapping table, MAPPING_2NxN[9] (shown in equation (1)) is used to map modes 26-34 of Table 11 to Intra prediction modes that are allowed by an 2NxN Intra PU as shown in Table 7. The mapping table in equation (1) is an abbreviated representation that maps the 9 “out of range” modes, i.e., 26,...,34, to modes {14,15,8,16,2,2,17,9,18} respectively. For example, mode index 26 (i.e., V+7) is mapped to mode index 14 (V+6) and mode index 34 (i.e., H+7) is mapped to mode index 18 (H+6).

$$\text{MAPPING_2NxN}[9] = \{14,15,8,16,2,2,17,9,18\} \quad (1)$$

In another embodiment, a 16x1 mapping table MAPPING_Nx2N[16] (shown in equation (2)) is used to map 16 “out of range” modes (i.e., 19-34) of Table 11 to Intra prediction modes that are allowed for an Nx2N Intra PU as shown in Table 8.

$$\text{MAPPING_Nx2N}[16] = \{11,5,12,1,1,13,6,14,19,20,21,22,23,24,25,10\} \quad (2)$$

In yet another embodiment, a 35x1 mapping table MAPPING_4x2[35] (shown in equation (3)) is used to map all the 35 modes in Table 11 to the 10 modes in Table 9.

$$\text{MAPPING_4x2}[35] = \{0,1,2,3,4,5,6,7,2,2,2,5,8,9,6,4,2,2,2,4,5,8,1,1,9,6,7,4,2,2,2,2,2,2\} \quad (3)$$

In a further embodiment, a 35x1 mapping table MAPPING_2x4[35] (shown in equation (4)) is used to map all the 35 modes in Table 11 to the 10 modes in Table 10.

$$\text{MAPPING_2x4}[35] = \{0,1,2,3,4,1,1,1,5,6,7,4,1,1,1,4,8,9,7,4,1,1,1,1,1,1,1,4,5,8,2,2,9,6,7\} \quad (4)$$

One aspect of the present invention addresses coding method for the Intra prediction modes associated with the 2NxN and Nx2N Intra partition types (i.e. PUs). More specifically, the method for the Intra prediction modes according to an embodiment of the present invention uses truncated binary coding method to code the Intra prediction modes for the 2NxN and Nx2N Intra partition types (i.e. PUs). As an example, the truncated binary coding may be applied to the 26 possible modes for the 2NxN and Nx2N Intra PUs as shown in Table 7 and Table 8 respectively. The

prediction mode for the current Intra PU may be the same as its top and/or left neighbors. The prediction modes correspond to the top and left neighbors may be used as the Most Probable Modes (MPMs). If the top or left neighbor (or their Intra prediction modes) does not exist, DC and/or Planar mode will be considered as an MPM. The two MPMs are signaled differently so that each of them can be identified individually. Consequently, codewords only need to be assigned to the 24 remaining non-MPM modes. Instead of assigning 5 bits to represent each mode by using the fixed binary representation, an embodiment according to the present invention uses truncated binary coding, as shown in Table 12. In the first exemplary implementation (Truncated Binary-1), the first eight modes use 4 bits, and the remaining modes use 5 bits. In the second exemplary implementation (Truncated Binary-2), the first 12 modes use 4 bits, the next 4 modes use 5 bits and the remaining modes use 6 bits.

Table 12

Mode index (after MPM)	Standard Binary	Truncated Binary -1	Truncated Binary -2
0	00000	0000	0000
1	00001	0001	0001
2	00010	0010	0010
3	00011	0011	0011
4	00100	0100	0100
5	00101	0101	0101
6	00110	0110	0110
7	00111	0111	0111
8	01000	10000	1000
9	01001	10001	1001
10	01010	10010	1010
11	01011	10011	1011
12	01100	10100	11000
13	01101	10101	11001
14	01110	10110	11010
15	01111	10111	11011
16	10000	11000	111000
17	10001	11001	111001
18	10010	11010	111010
19	10011	11011	111011
20	10100	11100	111100
21	10101	11101	111101
22	10110	11110	111110
23	10111	11111	111111

Another aspect of the present invention addresses Intra prediction modes for Intra PU with

sizes $2N \times (N/2)$ and $(N/2) \times 2N$. Intra prediction using PUs with $2N \times (N/2)$ and $(N/2) \times 2N$ sizes is also referred as SDIP (Short Distance Intra Prediction) in some literatures. In the SDIP previously proposed by others, an Intra PU may also be 32×8 , 8×32 , 16×4 , 4×16 , 8×2 and 2×8 blocks in addition to the Intra PU sizes that have been adopted by HEVC. Also in the previously proposed SDIP by others, the 35 Intra prediction modes that are used for 32×32 , 16×16 and 8×8 square Intra PUs are also applied to 32×8 , 8×32 , 16×4 , 4×16 Intra PUs. Furthermore, the 18 Intra prediction modes that are used for 4×4 square Intra PUs are applied to 8×2 and 2×8 Intra PUs.

An embodiment according to the present invention uses the prediction modes and directions defined in Table 13 for 16×4 Intra PUs and the prediction modes and directions defined in Table 14 for 4×16 Intra PUs. Same truncated binary coding methods and binary codewords as defined in Table 12 can be used for coding those modes. A person skilled in the art may use other truncated codes to practice the present invention as well.

Table 13

Index	0	1	2	3	4	5	6	7	8	9
Physical	PLA	V	H	DC	V-8	V-4	V+4	V+8	H-4	H+4
Index	10	11	12	13	14	15	16	17	18	19
Physical	H+8	V-6	V-2	V+2	V+6	H-6	H-2	H+2	H+6	V-7
Index	20	21	22	23	24	25				
Physical	V-5	V-3	V-1	V+1	V+3	V+5				

Table 14

Index	0	1	2	3	4	5	6	7	8	9
Physical	PLA	V	H	DC	V-8	V-4	V+4	V+8	H-4	H+4
Index	10	11	12	13	14	15	16	17	18	19
Physical	H+8	V-6	V-2	V+2	V+6	H-6	H-2	H+2	H+6	H-7
Index	20	21	22	23	24	25				
Physical	H-5	H-3	H-1	H+1	H+3	H+5				

Another embodiment according to the present invention uses 18 prediction modes for 8×2 Intra PUs (as shown in Table 15) and 2×8 PUs (as shown in Table 16). Therefore, after the two MPM modes are removed from the total of 18 modes, the remaining 16 modes require only 4 bits to present the remaining modes.

20

Table 15

Index	0	1	2	3	4	5	6	7	8	9
Physical	PLA	V	H	DC	V-8	V-4	V+4	V+8	V-2	V+2
Index	10	11	12	13	14	15	16	17		
Physical	V-6	V+6	V-5	V-3	V-1	V+1	V+3	V+5		

Table 16

Index	0	1	2	3	4	5	6	7	8	9
Physical	PLA	V	H	DC	V-8	H-4	H+4	H+8	H-2	H+2
Index	10	11	12	13	14	15	16	17		
Physical	H-6	H+6	H-5	H-3	H-1	H+1	H+3	H+5		

Yet another embodiment according to the present invention uses 10 prediction modes for 8x2 Intra PUs (as shown in Table 17) and 2x8 PUs (as shown in Table 18). Therefore, after the two MPM modes are removed from the total 10 modes, the remaining 8 modes require only 3 bits to present.

Table 17

Index	0	1	2	3	4	5	6	7	8	9
Physical	PLA	V	H	DC	V-8	V-4	V+4	V+8	V-2	V+2

Table 18

Index	0	1	2	3	4	5	6	7	8	9
Physical	PLA	V	H	DC	V-8	H-4	H+4	H+8	H-2	H+2

10

Embodiments according to the present invention allow both square transforms and non-square transforms be used to convert Intra prediction errors (also called prediction residues) corresponding to a block size of 2NxN or Nx2N into frequency domain. Three possible TU (transform unit) configurations are supported according to the present invention as shown in Table 7. In Table 7, the first column shows the sizes of Intra CU supported by HM-6.0 common test conditions. The second column shows the available PU sizes associated with each CU size. The third column of the table, i.e. "Square TU", provides first TU configuration where all TUs use square transforms and so-called residue quad-tree, i.e. RQT. According to HM-6.0 common test conditions, the maximum transform size is 32x32, the minimum transform size is 4x4 and the number of RQT depths is 3.

Examples of processing rectangular PUs using square TUs are shown in Fig. 4A and Fig. 5A, where a 2N \times 2N Intra CU is split into two 2N \times N or N \times 2N PUs. Each 2N \times N or N \times 2N PU is processed using two N \times N square TUs, i.e. PU0 is processed using TU0 and TU1, PU1 is processed using TU2 and TU3, respectively. Each TU can be further split into smaller transform blocks through RQT.

5 In order to take full advantage of rectangular Intra prediction partitioning and maximize the coding efficiency, non-square transforms are allowed for processing rectangular PUs. The fourth column of Table 19, i.e. “Non-square TU-1”, provides TU configuration that also supports a set of non-square transforms, known as non-square quad-tree transforms (NSQT) on rectangular Intra PUs in addition to the square transforms. In this TU configuration, 2N \times 0.5N and 0.5N \times 2N TU are applied to the 2N \times N and N \times 2N PU respectively, instead of applying N \times N transform to the 2N \times N or
 10 N \times 2N PU. Examples of processing rectangular PUs using non-square TUs are shown in Fig. 4B and Fig. 5B. In these examples, video data in TU0, TU1 and TU2 are used as the neighboring pixel on the top or on the left for predicting pixels in TU1, TU2 and TU3, respectively. TU0 and TU1 are associated with PU0 and thus share the same prediction mode specified in PU0 syntax. Similarly,
 15 TU2 and TU3 are associated with PU1 and thus share the same prediction mode specified in PU1 syntax. Each 2N \times 0.5N or 0.5N \times 2N TU can be further split into smaller 2N \times 0.5N or 0.5N \times 2N transform blocks respectively using quad-tree split. The smallest transform size allowed is 8 \times 2 and 2 \times 8 respectively. While the use of 8 \times 2 and 2 \times 8 prediction and transforms is shown to achieve some coding gain, the 2-point prediction and transforms may cause some complications in hardware
 20 implementation. Therefore, a modified configuration, i.e. “Non-square TU-2” is disclosed, where 8 \times 2 and 2 \times 8 TUs are eliminated and, instead 4 \times 4 TUs are used for 8 \times 4 and 4 \times 8 PUs.

Table 19

CU	PU	Square TU	Non-square TU – 1	Non-square TU – 2
64 \times 64	32 \times 32	32 \times 32 16 \times 16 8 \times 8	32 \times 32 16 \times 16 8 \times 8	32 \times 32 16 \times 16 8 \times 8
32 \times 32	32 \times 32	32 \times 32 16 \times 16 8 \times 8	32 \times 32 16 \times 16 8 \times 8	32 \times 32 16 \times 16 8 \times 8
	32 \times 16	16 \times 16 8 \times 8	32 \times 8 16 \times 4	32 \times 8 16 \times 4

	16x32	16x16 8x8	8x32 4x16	8x32 4x16
16x16	16x16	16x16 8x8 4x4	16x16 8x8 4x4	16x16 8x8 4x4
	16x8	8x8 4x4	16x4 8x2	16x4
	8x16	8x8 4x4	4x16 2x8	4x16
8x8	8x8	8x8 4x4	8x8 4x4	8x8 4x4
	8x4	4x4	8x2	4x4
	4x8	4x4	2x8	4x4
	4x4	4x4	4x4	4x4

The rectangular prediction block sizes (as shown in Table 19) are only applied in Luma Intra prediction according to an embodiment of the present invention. Chroma Intra prediction is still based on square blocks. In other words, when 2NxN or Nx2N PU is selected for Luma Intra prediction for a 2Nx2N CU, the block size for Chroma prediction is NxN. The reasons for maintaining square blocks for Chroma prediction are to avoid 2-point prediction and 2-point transforms for small-size CUs, and to keep the design simple. In HM-6.0, six modes are allowed for Chroma Intra prediction, which include DM (Direct mode), LM (Luma mode), Planar, DC, Vertical and Horizontal modes. The DM mode is the prediction mode that the Chroma block uses the prediction of the collocated Luma block. In most cases when the Luma PU type is 2Nx2N, the prediction mode that has been used for predicting the 2Nx2N Luma PU is used as the DM mode for predicting the collocated NxN Chroma block. However, when the NxN PU type is used for predicting a 2Nx2N CU, the prediction mode of the first NxN Luma PU is used as the DM mode for predicting the NxN Chroma block. In an embodiment according to the present invention, when 2NxN or Nx2N PU type is selected for the 2Nx2N CU, there will be two DM modes, referred as DM0 from PU0 and DM1 from PU1. The six Chroma prediction modes of a candidate set are derived as follows. LM, DM0, DM1, Planar, Vertical, Horizontal, DC and Vertical+8 are listed in this order to form an ordered mode set. Among these eight modes, the first six different modes are selected as the candidate set for Chroma Intra prediction.

The encoding process with the use of the rectangular Intra prediction partition according an embodiment of the present invention is described as follows. Early skips are used for reducing the

encoder search complexity and thus achieving better tradeoff between the compression efficiency and the encoding complexity. Fig. 6 illustrates an exemplary flowchart for best PU and mode decision. To determine the PU type for an Intra CU, the minimum R-D cost of using 2Nx2N PU is first calculated as shown in step 610. The Intra prediction mode that is associated with the minimum R-D cost is also obtained. Then the CU size is checked at step 620. If the CU is an SCU (i.e., the “Yes” branch of step 620), the minimum R-D cost of using NxN PU is also calculated as shown in step 640; the Intra prediction mode that is associated with the minimum R-D cost is obtained. The R-D costs of using 2Nx2N and NxN partition modes are used to decide whether to skip checking the R-D cost of using 2NxN and Nx2N partition modes as shown in step 650. In a reference implementation published by the same inventors (X. Zhang, S. Liu and S. Lei, “CE6.b: Rectangular (2NxN and Nx2N) PU for Intra Prediction”, JCTVC-H0437, Joint Collaborative Team on Video Coding (JCT-VC) of ITU-T VCEG and ISO/IEC MPEG, San Jose, CA, Feb. 2011), the number of bits of coding 2Nx2N PU is compared with a content adaptive threshold. The threshold T is calculated as in equation (5) when QP is not equal to 0,

$$T = a \times (64.0 / ((QP < 32) ? QP : 64)), \quad (5)$$

where the parameter a is set as 10, 30 and 300 for 8x8, 16x16 and 32x32 CUs, respectively. If the current CU is 32x32 and the number of bits used by 2Nx2N PU is less than the threshold, the non-square PU will be checked; otherwise, the non-square PU will be skipped. If the current CU is 16x16 or 8x8 and the number of bits used by the 2Nx2N PU is larger than the threshold, the non-square PU will be checked; otherwise, the non-square PU will be skipped.

When the 2-point prediction and transforms are eliminated, instead 4x4 TU is used for an 8x4 and 4x8 PU, additional early skips may be applied. For an SCU, if the number of bits used by the 2Nx2N PU is less than the threshold T defined in (5) with parameter a set to 5, the check of using NxN PU will be skipped. Furthermore, if R-D cost of the NxN PU is larger than the R-D cost of the 2Nx2N PU, the check of using 2NxN and Nx2N PUs will be skipped.

The mode decision for a PU is achieved in two steps, as illustrated in Fig. 7. First, a set of M ($M \leq 35$) mode candidates and the best 2Nx2N mode are examined based on the Sum of Absolute Transformed Differences (SATD) in step 710. Hadamard transform is used in calculating the SATD. Among the set of M mode candidates, the K ($K \leq M$) candidates with the least SATD cost are selected for actual R-D cost comparison along with the most probable modes (MPM) if they are different to the K best candidates, as shown in step 720. If the CU is an SCU, and 4x4 TUs are used for 8x4 and 4x8 PU, the actual R-D cost of using the best NxN modes are also calculated and

compared. Finally the mode with the minimum actual R-D cost is selected as the prediction mode for this PU. In the reference implementation(X. Zhang, S. Liu and S. Lei, “CE6.b: Rectangular (2NxN and Nx2N) PU for Intra Prediction”, JCTVC-H0437, Joint Collaborative Team on Video Coding (JCT-VC) of ITU-T VCEG and ISO/IEC MPEG, San Jose, CA, Feb. 2011), M is set to 19 and K is set to 2.

The performance of a rectangular (2NxN and Nx2N) Intra PU structure incorporating non-square transforms according to an embodiment of the present invention is compared with a system that only uses square transforms for a rectangular (2NxN and Nx2N) Intra PU structure. In HEVC Test Model, the system supports several encoder configurations, such as All Intra, Random access, and Low delay. Also, the HEVC Test Model uses sets of test sequences, called *classes*, with different spatial resolutions. The performance is measured in terms of BD-rate, which is a well known performance measurement in the field of video coding. An improved performance is indicated by a negative BD-rate. Performance comparisons corresponding to the Intra PU structure incorporating the set of non-square TUs labeled as “Non-square TU – 1” in Table 19 and a system that only uses square TUs are shown in Tables 20A-20C, where Table 20A corresponds to the All Intra configuration, Table 20B corresponds to the Random access configuration and Table 20C corresponds to the Low delay configuration. In Tables 20A-20C, the execution times for performing the respective encoding and decoding are also compared.

Table 20A

	All Intra		
	Y BD-rate	U BD-rate	V BD-rate
Class A (4K)	-0.9%	-2.0%	-2.6%
Class B (1080p)	-1.2%	-2.1%	-2.2%
Class C (WVGA)	-1.7%	-1.8%	-2.0%
Class D (WQVGA)	-1.7%	-1.5%	-1.5%
Class E (720p)	-1.9%	-4.8%	-4.1%
All	-1.5%	-2.3%	-2.4%
Enc Time[%]	126%		
Dec Time[%]	103%		

20

Table 20B

	Random access		
	Y BD-rate	U BD-rate	V BD-rate
Class A (4K)	-0.6%	-1.6%	-2.2%
Class B (1080p)	-0.7%	-1.3%	-1.2%
Class C (WVGA)	-0.9%	-1.1%	-1.0%

Class D (WQVGA)	-0.7%	-0.8%	-0.7%
Class E (720p)			
All	-0.7%	-1.3%	-1.2%
Enc Time[%]		104%	
Dec Time[%]		101%	

Table 20C

	Low delay		
	Y BD-rate	U BD-rate	V BD-rate
Class A (4K)			
Class B (1080p)	-0.2%	-0.4%	-0.2%
Class C (WVGA)	-0.3%	-0.6%	-0.4%
Class D (WQVGA)	-0.2%	-0.4%	-0.6%
Class E (720p)	-0.5%	-2.4%	-2.5%
All	-0.3%	-0.8%	-0.8%
Enc Time[%]		103%	
Dec Time[%]		100%	

Table 21A

	All Intra		
	Y BD-rate	U BD-rate	V BD-rate
Class A (4K)	-1.4%	-3.7%	-4.2%
Class B (1080p)	-1.3%	-3.4%	-3.5%
Class C (WVGA)	-1.3%	-2.4%	-2.5%
Class D (WQVGA)	-1.2%	-1.9%	-1.9%
Class E (720p)	-2.2%	-7.2%	-6.7%
All	-1.4%	-3.5%	-3.6%
Enc Time[%]		126%	
Dec Time[%]		103%	

Table 21B

	Random access		
	Y BD-rate	U BD-rate	V BD-rate
Class A (4K)	-0.9%	-2.8%	-3.2%
Class B (1080p)	-0.8%	-2.2%	-2.4%
Class C (WVGA)	-0.7%	-1.7%	-1.6%
Class D (WQVGA)	-0.5%	-1.6%	-1.1%
Class E (720p)			
All	-0.7%	-2.0%	-1.9%
Enc Time[%]		103%	
Dec Time[%]		100%	

Table 21C

	Low delay		
	Y BD-rate	U BD-rate	V BD-rate
Class A (4K)			
Class B (1080p)	-0.3%	-0.7%	-0.6%
Class C (WVGA)	-0.2%	-1.0%	-0.7%
Class D (WQVGA)	-0.1%	-1.0%	-1.0%
Class E (720p)	-0.5%	-2.7%	-5.4%
All	-0.3%	-1.2%	-1.6%
Enc Time[%]	102%		
Dec Time[%]	100%		

As shown in Tables 20A-21C, a rectangular (2NxN and Nx2N) Intra PU structure incorporating non-square transforms according to an embodiment of the present invention demonstrates improved performance consistently. For the All Intra configuration, the encoding time increases noticeably. However, for other cases, the encoding time and decoding time are comparable with the encoding time and decoding time of a system only uses square TUs respectively.

The above description is presented to enable a person of ordinary skill in the art to practice the present invention as provided in the context of a particular application and its requirement. Various modifications to the described embodiments will be apparent to those with skill in the art, and the general principles defined herein may be applied to other embodiments. Therefore, the present invention is not intended to be limited to the particular embodiments shown and described, but is to be accorded the widest scope consistent with the principles and novel features herein disclosed. In the above detailed description, various specific details are illustrated in order to provide a thorough understanding of the present invention. Nevertheless, it will be understood by those skilled in the art that the present invention may be practiced.

Embodiment of the present invention as described above may be implemented in various hardware, software code, or a combination of both. For example, an embodiment of the present invention can be a circuit integrated into a video compression chip or program code integrated into video compression software to perform the processing described herein. An embodiment of the present invention may also be program code to be executed on a Digital Signal Processor (DSP) to perform the processing described herein. The invention may also involve a number of functions to be performed by a computer processor, a digital signal processor, a microprocessor, or field programmable gate array (FPGA). These processors can be configured to perform particular tasks according to the invention, by executing machine-readable software code or firmware code that

defines the particular methods embodied by the invention. The software code or firmware code may be developed in different programming languages and different formats or styles. The software code may also be compiled for different target platforms. However, different code formats, styles and languages of software codes and other means of configuring code to perform the
5 tasks in accordance with the invention will not depart from the spirit and scope of the invention.

The invention may be embodied in other specific forms without departing from its spirit or essential characteristics. The described examples are to be considered in all respects only as illustrative and not restrictive. The scope of the invention is therefore, indicated by the appended claims rather than by the foregoing description. All changes which come within the meaning and
10 range of equivalency of the claims are to be embraced within their scope.

CLAIMS

1. A method for Intra prediction of a block based on neighboring pixels around the block, the method comprising:

receiving a Luma block corresponding to Luma pixels of the block; and

5 performing Intra prediction for the Luma block based on neighboring Luma pixels, wherein the Luma block is partitioned into one or more PUs (prediction units) having a shape from a group consisting of a square shape and a non-square shape.

2. The method of Claim 1, wherein the Luma block corresponds to a $2N \times 2N$ Luma CU (coding unit) and said one or more PUs correspond to $2N \times N$, $N \times 2N$, $2N \times 2N$ or $N \times N$ PUs.

10 3. The method of Claim 2, partition modes associated with said one or more PUs are indicated using a codeword table for the Luma block in Intra and Inter slices, wherein the codeword table includes entries for the $2N \times N$ and $N \times 2N$ PUs.

4. The method of Claim 2, wherein the $2N \times N$ PU or the $N \times 2N$ PU is processed either using square transforms only or using both non-square and the square transforms.

15 5. The method of Claim 4, wherein, when the $2N \times N$ PU or the $N \times 2N$ PU is processed as two $N \times N$ TUs (transform units), each of the $N \times N$ TU is further split into smaller $N \times N$ TUs based on quad-tree split if the $N \times N$ TU is larger than a smallest size, and wherein the smaller $N \times N$ TUs associated with the $2N \times N$ PU or the $N \times 2N$ PU use a same Intra prediction mode as the $2N \times N$ PU or the $N \times 2N$ PU respectively.

20 6. The method of Claim 5, wherein the smallest size corresponds to 4×4 .

7. The method of Claim 4, wherein the $2N \times N$ PU is processed as two $2N \times 0.5N$ TUs (transform units) and the $2N \times 0.5N$ TU is further split into smaller $2N \times 0.5N$ TUs based on quad-tree split if the $2N \times 0.5N$ TU is larger than a smallest size, and wherein the smaller $2N \times 0.5N$ TUs associated with the $2N \times N$ PU use a same Intra prediction mode as the $2N \times N$ PU.

25 8. The method of Claim 7, wherein the smallest size corresponds to 8×2 .

9. The method of Claim 4, wherein the $N \times 2N$ PU is processed as two $0.5N \times 2N$ TUs (transform units) and the $0.5N \times 2N$ TU is further split into smaller $0.5N \times 2N$ TUs based on quad-tree split if the $0.5N \times 2N$ TU is larger than a smallest size, and wherein the smaller $0.5N \times 2N$ TUs associated with the $N \times 2N$ PU use a same Intra prediction mode as the $N \times 2N$ PU.

30 10. The method of Claim 9, wherein the smallest size corresponds to 2×8 .

11. The method of Claim 4, wherein the $2N \times N$ PU is processed as two $2N \times 0.5N$ TUs (transform units) if the $2N \times 2N$ Luma CU is larger than 8×8 , wherein the $2N \times 0.5N$ TU is further

split into smaller $2N \times 0.5N$ TUs based on quad-tree split if the $2N \times 0.5N$ TU is larger than 16×4 ; and wherein the $2N \times N$ PU is processed as two 4×4 TUs if the $2N \times 2N$ Luma CU has a size of 8×8 .

12. The method of Claim 4, wherein the $N \times 2N$ PU is processed as two $0.5N \times 2N$ TUs (transform units) if the $2N \times 2N$ Luma CU is larger than 8×8 , wherein the $0.5N \times 2N$ TU is further
5 split into smaller $0.5N \times 2N$ TUs based on quad-tree split if the $0.5N \times 2N$ TU is larger than 4×16 ; and wherein the $N \times 2N$ PU is processed as two 4×4 TUs if the $2N \times 2N$ Luma CU has a size of 8×8 .

13. The method of Claim 1, further comprising:

receiving a Chroma block corresponding to Chroma pixels of the block; and

performing Intra prediction for the Chroma block, wherein the Chroma block is partitioned
10 into one or more Chroma PUs having the square shape only.

14. The method of Claim 13, wherein the Chroma block corresponding to a $2N \times 2N$ CU is Intra predicted using $N \times N$ block size, wherein a candidate set of Chroma Intra prediction modes is derived for the Chroma block.

15. The method of Claim 13, wherein an ordered mode set of Chroma Intra prediction modes
15 consisting of {LM, DM0, DM1, Planar, Vertical, Horizontal, DC and Vertical+8} are used to derive a candidate set for the Chroma Intra prediction modes, wherein DM0 and DM1 correspond to two DMs (direct modes) associated with two non-square PUs of a $2N \times 2N$ Luma CU respectively, and wherein first six different modes of the ordered mode set are selected as candidate modes of the candidate set for Chroma Intra prediction.

20 16. An apparatus for Intra prediction of a block based on neighboring pixels around the block, the apparatus comprising:

means for receiving a Luma block corresponding to Luma pixels of the block; and

means for performing Intra prediction for the Luma block based on neighboring Luma pixels,
wherein the Luma block is partitioned into one or more PUs (prediction units) having a shape from
25 a group consisting of a square shape and a non-square shape.

17. The apparatus of Claim 16, wherein the Luma block corresponds to a $2N \times 2N$ Luma CU (coding unit) and said one or more PUs correspond to $2N \times N$, $N \times 2N$, $2N \times 2N$ or $N \times N$ PUs.

18. The apparatus of Claim 17, partition modes associated with said one or more PUs are indicated using a codeword table for the Luma block in Intra and Inter slices, wherein the codeword
30 table includes entries for the $2N \times N$ and $N \times 2N$ PUs.

19. The apparatus of Claim 17, wherein the $2N \times N$ PU or the $N \times 2N$ PU is processed either using square transforms only or using both non-square and the square transforms.

20. The apparatus of Claim 19, wherein, when the $2N \times N$ PU or the $N \times 2N$ PU is processed as two $N \times N$ TUs (transform units), each of the $N \times N$ TU is further split into smaller $N \times N$ TUs based on

quad-tree split if the $N \times N$ TU is larger than a smallest size, and wherein the smaller $N \times N$ TUs associated with the $2N \times N$ PU or the $N \times 2N$ PU use a same Intra prediction mode as the $2N \times N$ PU or the $N \times 2N$ PU respectively.

21. The apparatus of Claim 19, wherein the $2N \times N$ PU is processed as two $2N \times 0.5N$ TUs (transform units) and the $2N \times 0.5N$ TU is further split into smaller $2N \times 0.5N$ TUs based on quad-tree split if the $2N \times 0.5N$ TU is larger than a smallest size, and wherein the smaller $2N \times 0.5N$ TUs associated with the $2N \times N$ PU use a same Intra prediction mode as the $2N \times N$ PU.

22. The apparatus of Claim 19, wherein the $N \times 2N$ PU is processed as two $0.5N \times 2N$ TUs (transform units) and the $0.5N \times 2N$ TU is further split into smaller $0.5N \times 2N$ TUs based on quad-tree split if the $0.5N \times 2N$ TU is larger than a smallest size, and wherein the smaller $0.5N \times 2N$ TUs associated with the $N \times 2N$ PU use a same Intra prediction mode as the $N \times 2N$ PU.

23. The apparatus of Claim 19, wherein the $2N \times N$ PU is processed as two $2N \times 0.5N$ TUs (transform units) if the $2N \times 2N$ Luma CU is larger than 8×8 , wherein the $2N \times 0.5N$ TU is further split into smaller $2N \times 0.5N$ TUs based on quad-tree split if the $2N \times 0.5N$ TU is larger than 16×4 ; and wherein the $2N \times N$ PU is processed as two 4×4 TUs if the $2N \times 2N$ Luma CU has a size of 8×8 .

24. The apparatus of Claim 19, wherein the $N \times 2N$ PU is processed as two $0.5N \times 2N$ TUs (transform units) if the $2N \times 2N$ Luma CU is larger than 8×8 , wherein the $0.5N \times 2N$ TU is further split into smaller $0.5N \times 2N$ TUs based on quad-tree split if the $0.5N \times 2N$ TU is larger than 4×16 ; and wherein the $N \times 2N$ PU is processed as two 4×4 TUs if the $2N \times 2N$ Luma CU has a size of 8×8 .

25. The apparatus of Claim 16, further comprising:

means for receiving a Chroma block corresponding to Chroma pixels of the block; and

means for performing Intra prediction for the Chroma, wherein the Chroma block is partitioned into one or more Chroma PUs having the square shape only.

26. The apparatus of Claim 25, wherein the Chroma block corresponding to a $2N \times 2N$ CU is Intra predicted using $N \times N$ block size, wherein a candidate set of Chroma Intra prediction modes is derived for the Chroma block.

27. The apparatus of Claim 25, wherein an ordered mode set of Chroma Intra prediction modes consisting of {LM, DM0, DM1, Planar, Vertical, Horizontal, DC and Vertical+8} are used to derive a candidate set for the Chroma Intra prediction modes, wherein DM0 and DM1 correspond to two DMs (direct modes) associated with two non-square PUs of a $2N \times 2N$ Luma CU respectively, and wherein first six different modes of the ordered mode set are selected as candidate modes of the candidate set for Chroma Intra prediction.

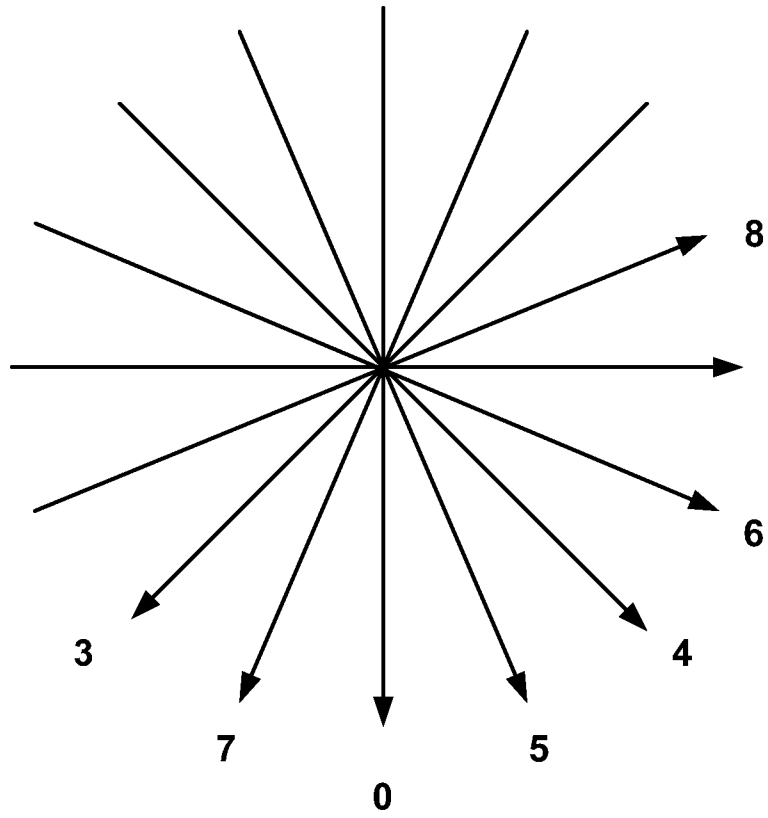

Fig.1

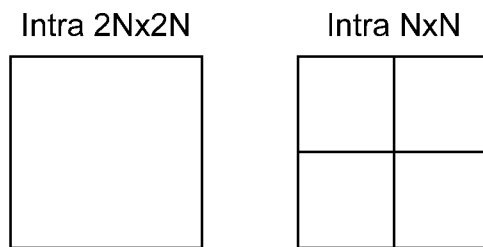

Fig.2A

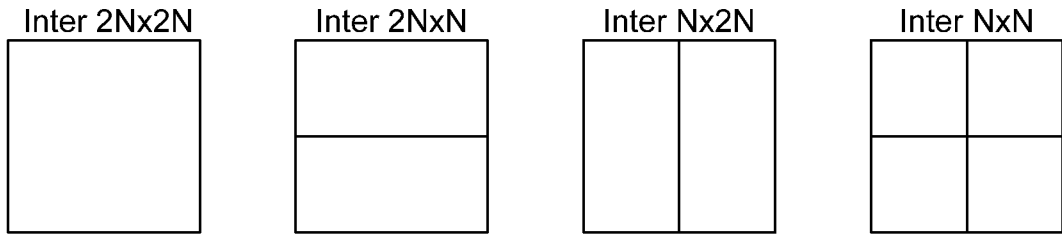

Fig.2B

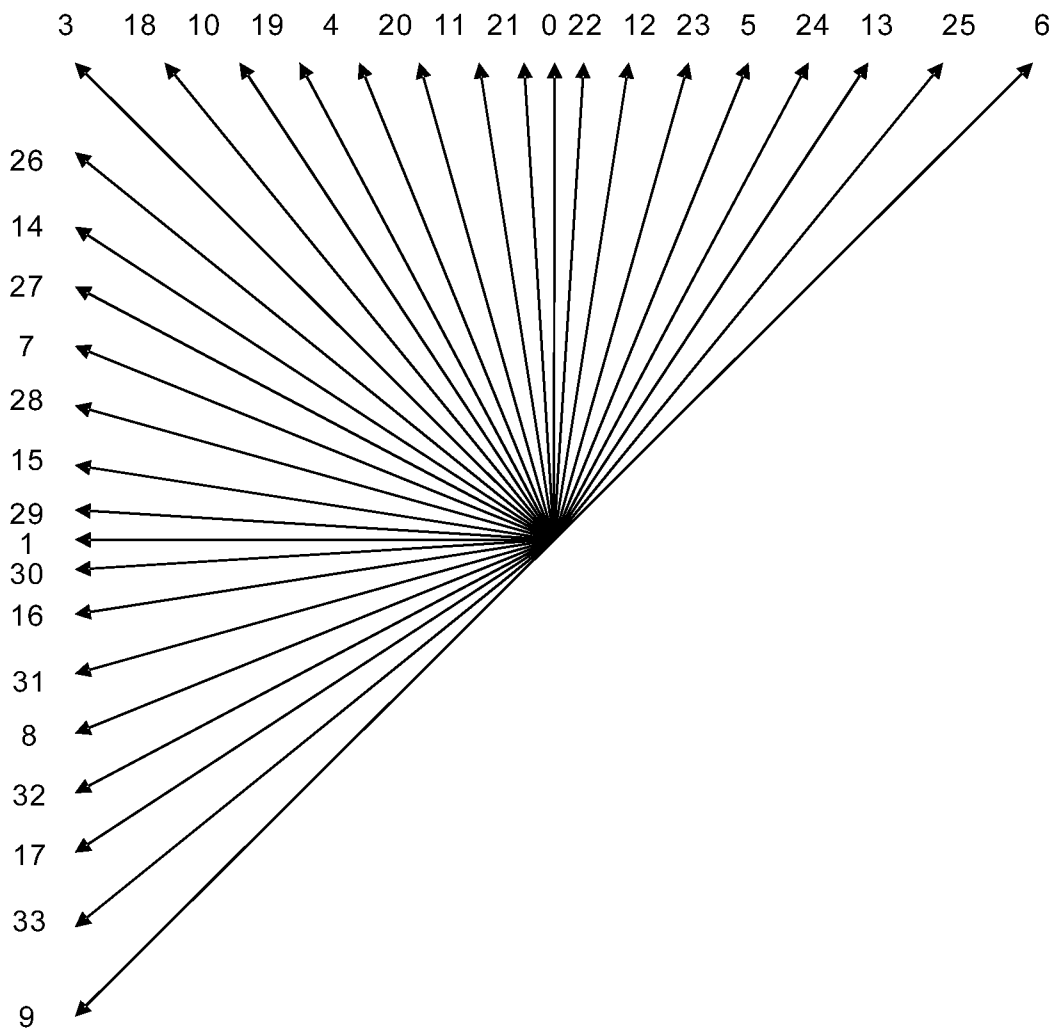

Fig.3A

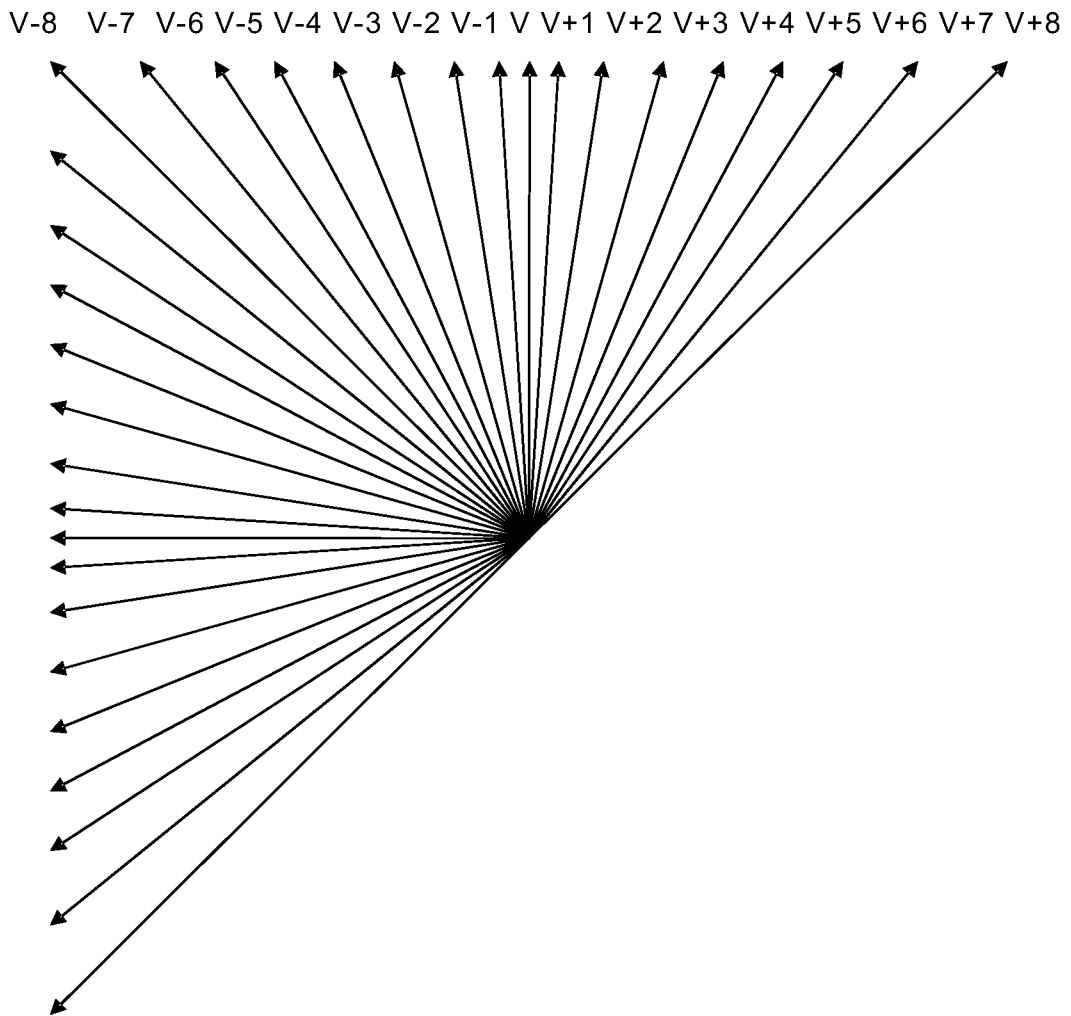

Fig.3B

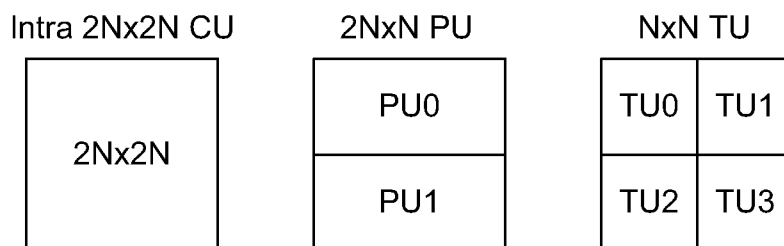

Fig.4A

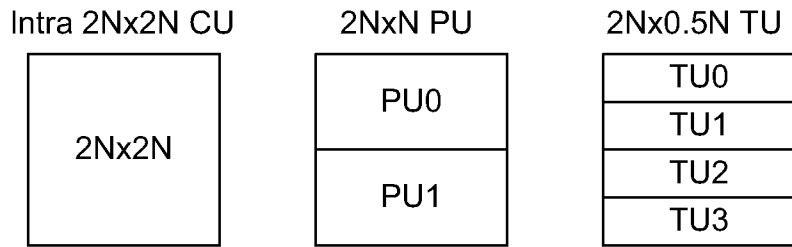

Fig.4B

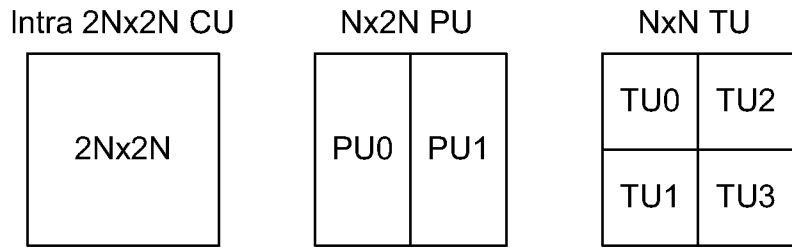

Fig.5A

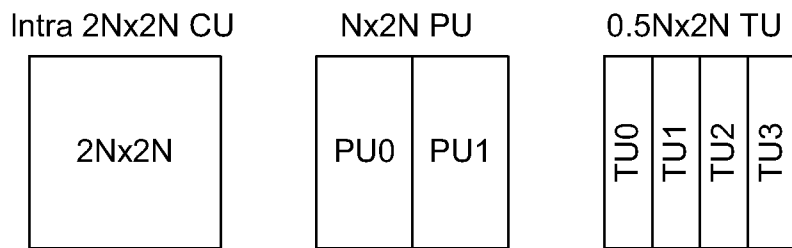

Fig.5B

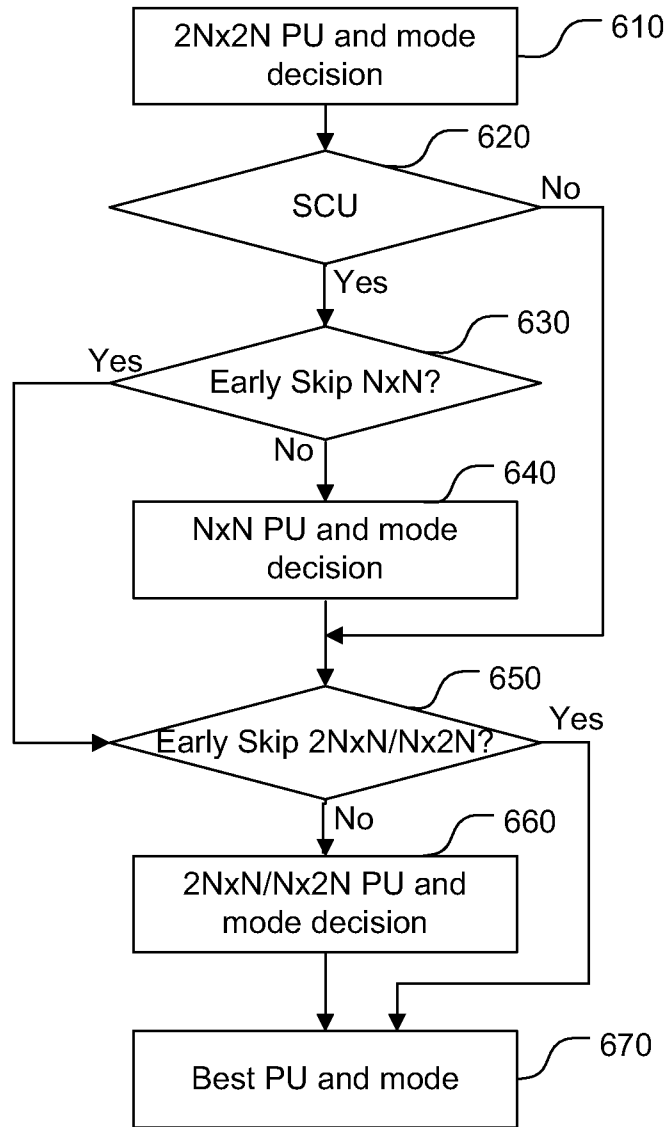

Fig.6

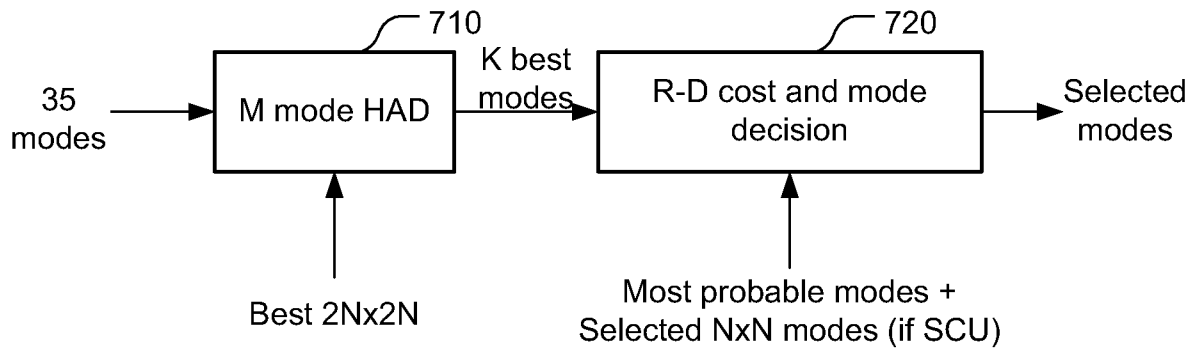

Fig.7

INTERNATIONAL SEARCH REPORT

International application No.
PCT/CN2012/079165

A. CLASSIFICATION OF SUBJECT MATTER

See extra sheet

According to International Patent Classification (IPC) or to both national classification and IPC

B. FIELDS SEARCHED

Minimum documentation searched (classification system followed by classification symbols)

H04N7-;

Documentation searched other than minimum documentation to the extent that such documents are included in the fields searched

Electronic data base consulted during the international search (name of data base and, where practicable, search terms used)

CNPAT, EPODOC, WPI, CNKI: frame, video, cod+, prediction, intra, divid+, area, block, segment+, non-square.

C. DOCUMENTS CONSIDERED TO BE RELEVANT

Category*	Citation of document, with indication, where appropriate, of the relevant passages	Relevant to claim No.
X	LIM Jeongyeon et al. Description of video coding technology proposal by SK telecom, Sejong Univ. and Sungkyunkwan Univ. Joint Collaborative Team on Video Coding (JCT-VC) of ITU-T SG16 WP3 and ISO/IEC JTC1/SC29/WG11. Document: JCTVC-A113. 1st Meeting: Dresden, DE, 15-23 April, 2010, page1-page 41.	1-27
A	WO 2010/084692 A1(NTT DOCOMO INC. et al.)29 Jul .2010 (29.07.2010) The whole document	1-27
A	CN1874521 A (SAMSUNG ELECTRONICS CO. LTD.) 06 Dec. 2006(06.12.2006) The whole document	1-27
A	CN100592796 C(INST COMPUTING TECH CN ACAD SCI. et al.) 24 Feb. 2010(24.02.2010) The whole document	1-27
A	EP2202986A1(HUAWEI TECHNOLOGIES CO. LTD.)30 Jun .2010(30.06.2010) The whole document	1-27

Further documents are listed in the continuation of Box C.

See patent family annex.

<p>* Special categories of cited documents:</p> <p>“A” document defining the general state of the art which is not considered to be of particular relevance</p> <p>“E” earlier application or patent but published on or after the international filing date</p> <p>“L” document which may throw doubts on priority claim (S) or which is cited to establish the publication date of another citation or other special reason (as specified)</p> <p>“O” document referring to an oral disclosure, use, exhibition or other means</p> <p>“P” document published prior to the international filing date but later than the priority date claimed</p>	<p>“T” later document published after the international filing date or priority date and not in conflict with the application but cited to understand the principle or theory underlying the invention</p> <p>“X” document of particular relevance; the claimed invention cannot be considered novel or cannot be considered to involve an inventive step when the document is taken alone</p> <p>“Y” document of particular relevance; the claimed invention cannot be considered to involve an inventive step when the document is combined with one or more other such documents, such combination being obvious to a person skilled in the art</p> <p>“&”document member of the same patent family</p>
--	--

Date of the actual completion of the international search 16 Oct .2012(16.10.2012)	Date of mailing of the international search report 08 Nov. 2012 (08.11.2012)
---	--

Name and mailing address of the ISA/CN
The State Intellectual Property Office, the P.R.China
6 Xitucheng Rd., Jimen Bridge, Haidian District, Beijing, China
100088
Facsimile No. 86-10-62019451

Authorized officer
ZHANG Qianzhen
Telephone No. (86-10)62413922

INTERNATIONAL SEARCH REPORT
Information on patent family members

International application No.
PCT/CN2012/079165

Patent Documents referred in the Report	Publication Date	Patent Family	Publication Date
WO2010/084692A1	29.07.2010	US2011/0286679A1	24.11.2011
		CN102227911A	26.10.2011
		AU2009338306A1	29.07.2010
		CA2750552A1	29.07.2010
		EP2384003A1	02.11.2011
CN1874521A	06.12.2006	EP1729520A2	06.12.2006
		KR20060123939A	05.12.2006
		US2006/0268982A1	30.11.2006
CN100592796C	24.02.2010	CN101252695A	27.08.2008
EP2202986A1	30.06.2010	CN101415121A	22.04.2009
		US2010/0195715A1	05.08.2010
		WO2009/052740A1	30.04.2009
		CN101415121B	29.09.2010

INTERNATIONAL SEARCH REPORT

International application No.

PCT/CN2012/079165

CLASSIFICATION OF SUBJECT MATTER

IPC:

H04N7/32(2006.01) i;

H04N7/26(2006.01) n;