



US00D744774S

(12) **United States Design Patent**
Bock et al.

(10) **Patent No.:** **US D744,774 S**

(45) **Date of Patent:** **** Dec. 8, 2015**

(54) **BEVERAGE MAKER**

(71) Applicant: **Hamilton Beach Brands, Inc.**, Glen Allen, VA (US)

(72) Inventors: **Brian Bock**, Midlothian, VA (US);
Patrick T Mulvaney, Richmond, VA (US)

(73) Assignee: **Hamilton Beach Brands, Inc.**, Glen Allen, VA (US)

(**) Term: **14 Years**

(21) Appl. No.: **29/484,936**

(22) Filed: **Mar. 14, 2014**

Related U.S. Application Data

(63) Continuation of application No. 13/754,158, filed on Jan. 30, 2013.

(51) **LOC (10) Cl.** **07-01**

(52) **U.S. Cl.**
USPC **D7/306; D7/311**

(58) **Field of Classification Search**

USPC D7/306-311, 305, 300, 313; 99/279, 99/284, 290, 280, 299, 307, 323.1; 222/23, 129.1; 62/395; D20/1

CPC A47J 31/44; A47J 31/00; B67D 1/0041; B67D 3/00

See application file for complete search history.

(56) **References Cited**

U.S. PATENT DOCUMENTS

D343,757 S * 2/1994 Bannigan D7/309
6,606,938 B2 8/2003 Taylor
6,708,600 B2 3/2004 Winkler et al.
D514,865 S * 2/2006 Steiner D7/309

D514,867 S * 2/2006 Steiner D7/309
7,047,870 B2 * 5/2006 Gantt et al. 99/305
7,059,239 B2 6/2006 Balkau
D546,112 S * 7/2007 Rorke et al. D7/309
D558,506 S * 1/2008 Garman D7/309
D559,611 S * 1/2008 Cheong D7/306
D570,149 S * 6/2008 Truong D7/309
D571,598 S * 6/2008 Moore D7/306
7,677,157 B2 3/2010 Steiner et al.
D620,302 S * 7/2010 Picozza et al. D7/309
D622,536 S * 8/2010 Ågren et al. D7/309
D623,461 S * 9/2010 Ashbridge D7/306
7,997,187 B2 * 8/2011 Garman et al. 99/304
2008/0115674 A1 5/2008 Huang et al.
2013/0095212 A1 4/2013 Beer
2013/0236618 A1 9/2013 Tinkler et al.

* cited by examiner

Primary Examiner — Marianne Pandozzi

(74) *Attorney, Agent, or Firm* — Alexander D. Raring

(57) **CLAIM**

The ornamental design for a beverage maker, as shown and described.

DESCRIPTION

FIG. 1 a front perspective view of a beverage maker showing our new design;
FIG. 2 is a front elevation view thereof;
FIG. 3 is a left side elevation view thereof;
FIG. 4 is a right side elevation view thereof;
FIG. 5 is a rear elevation view thereof;
FIG. 6 is a top plan view thereof;
FIG. 7 is a bottom plan view thereof; and,
FIG. 8 is a rear perspective view thereof.
The broken lines in the figures are for the purpose of showing environmental structure and form no part of the claimed design.

1 Claim, 8 Drawing Sheets

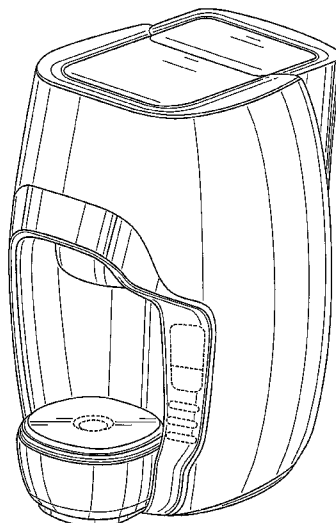

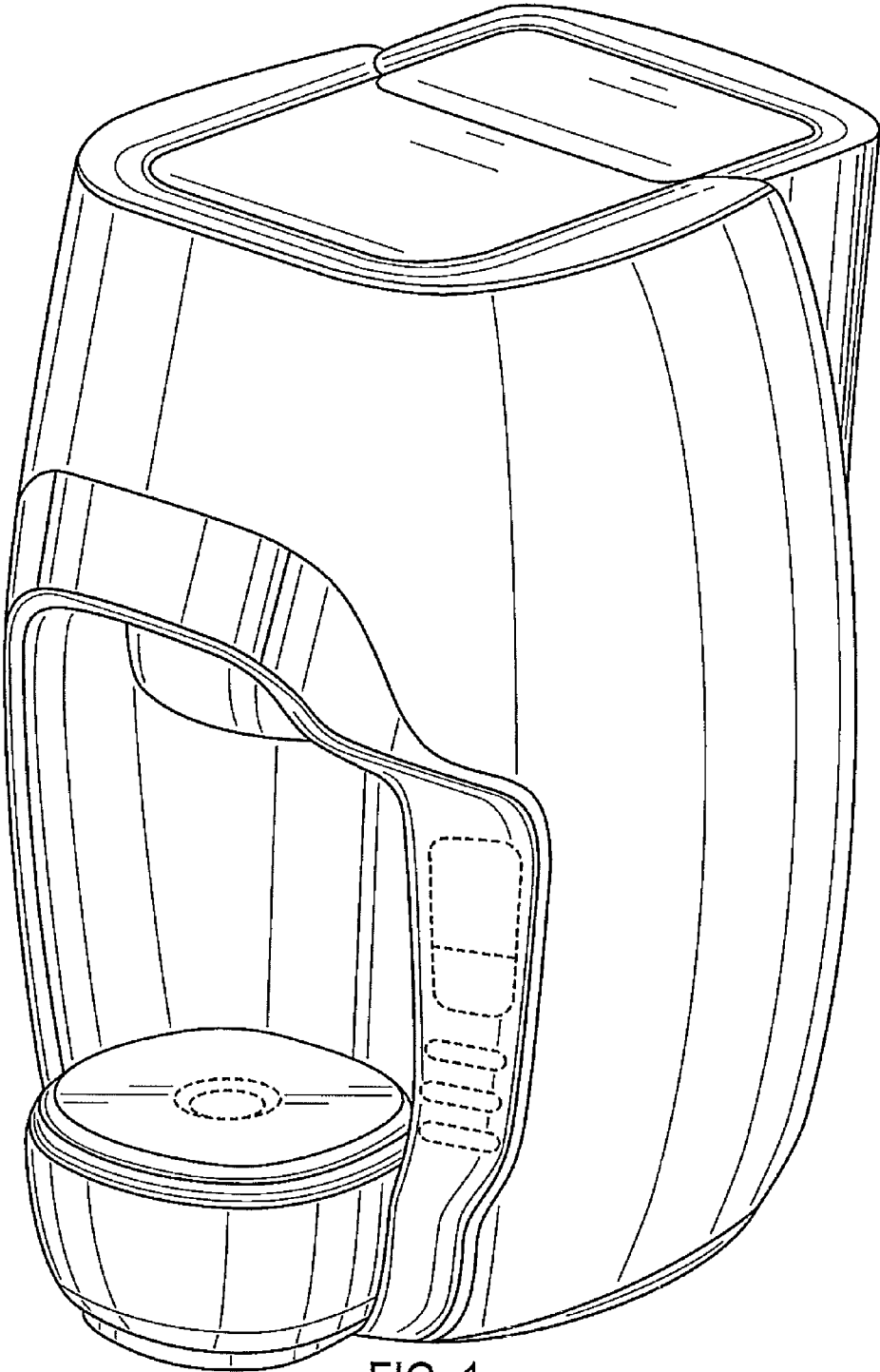

FIG. 1

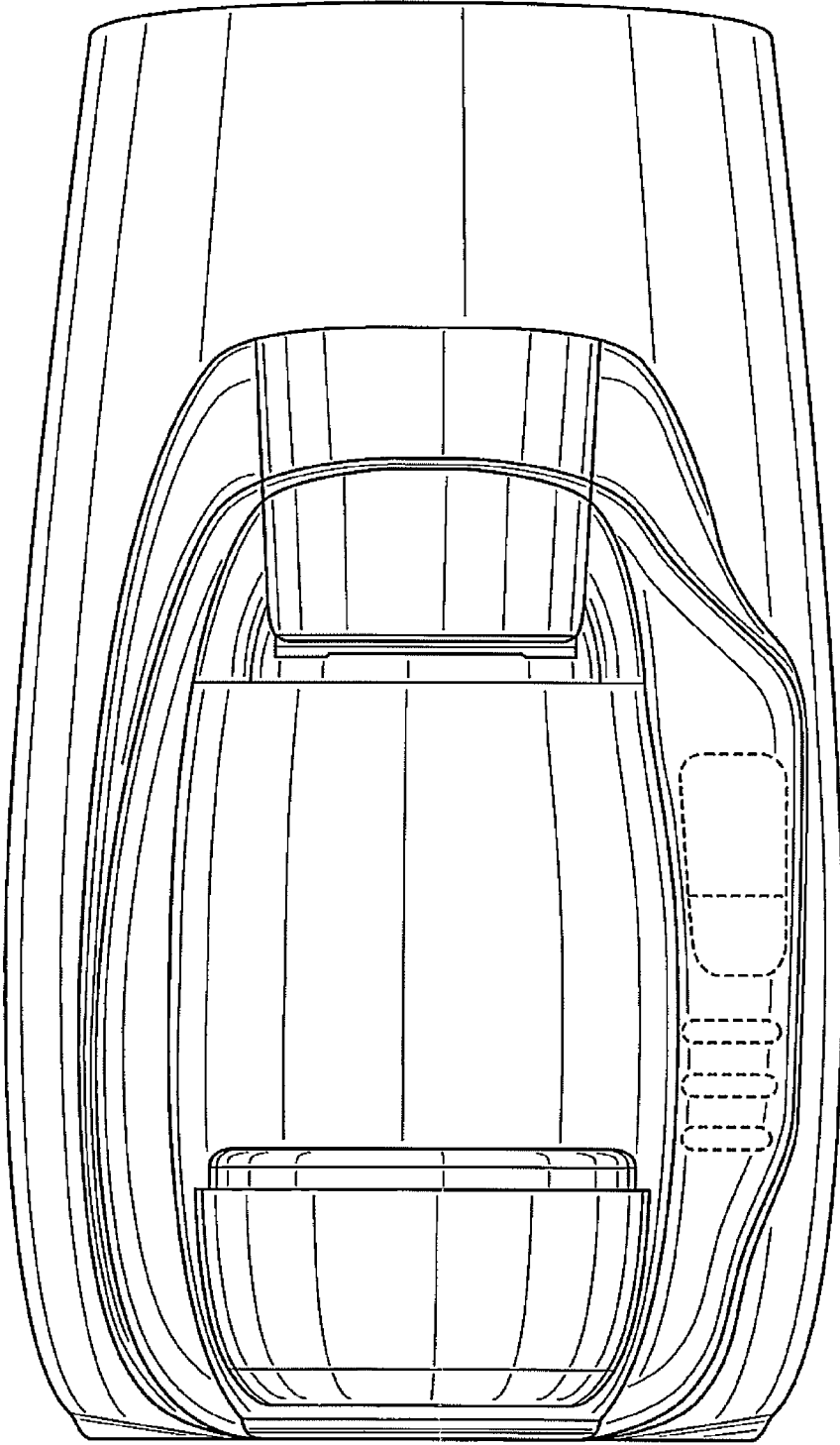

FIG. 2

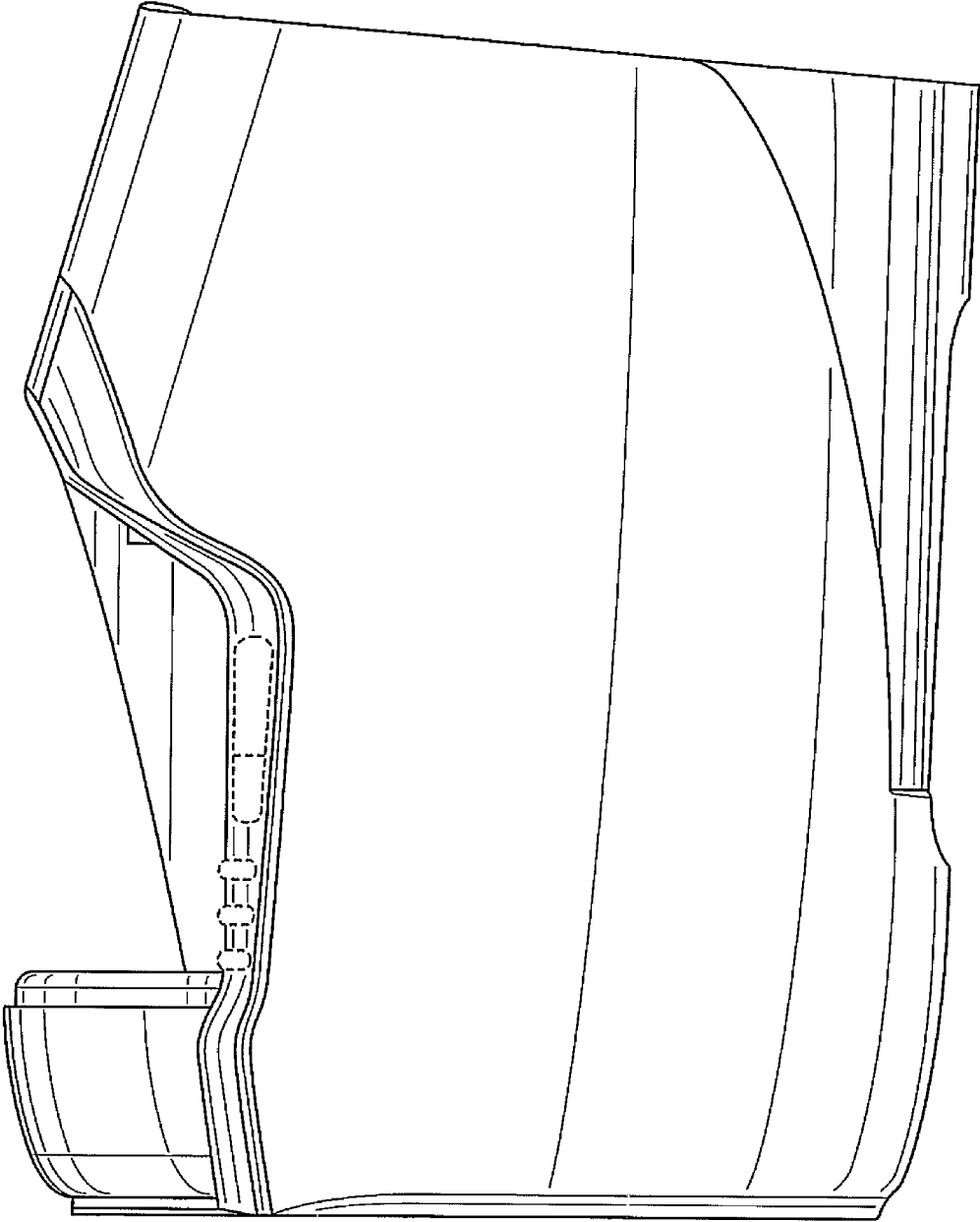

FIG. 3

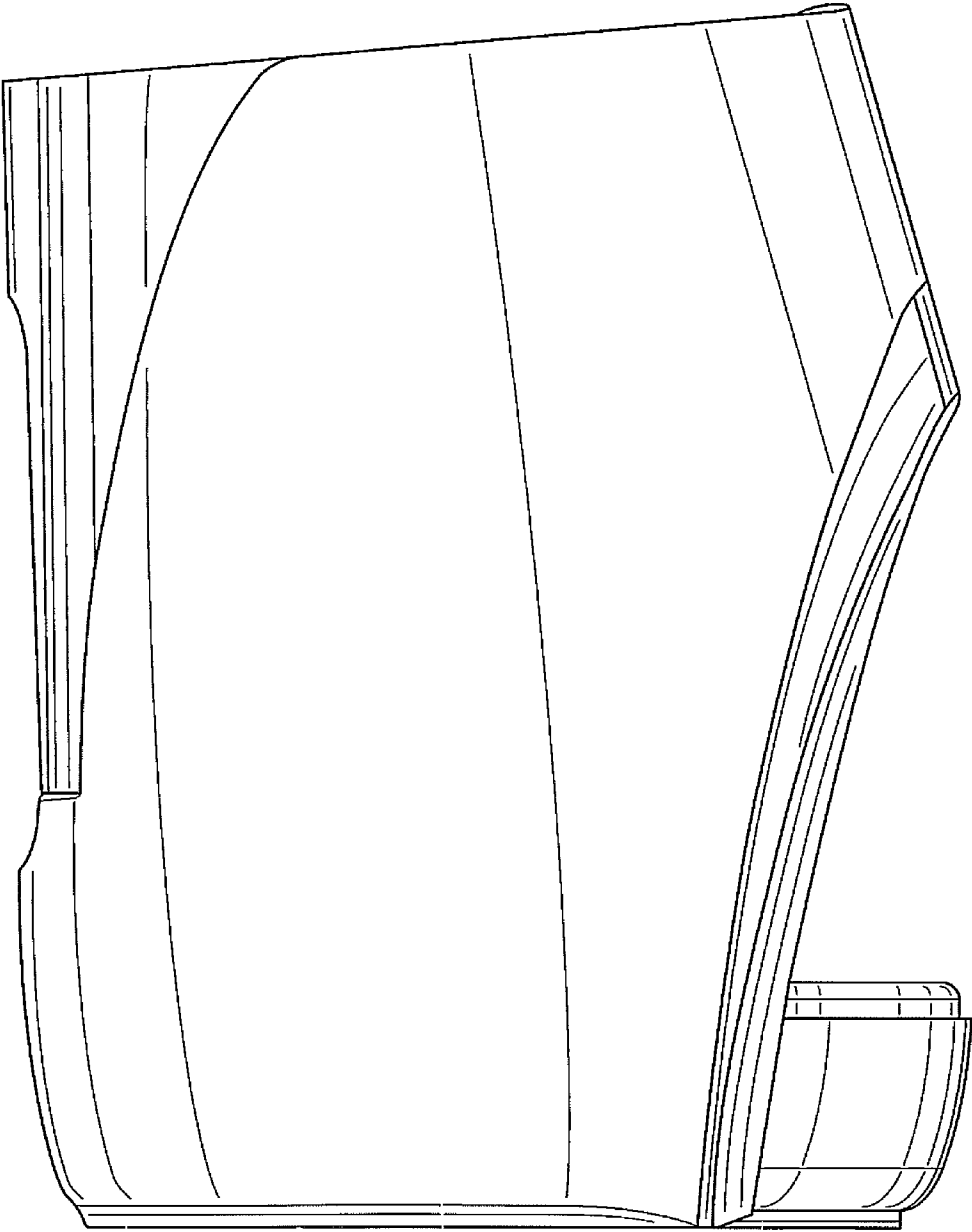

FIG. 4

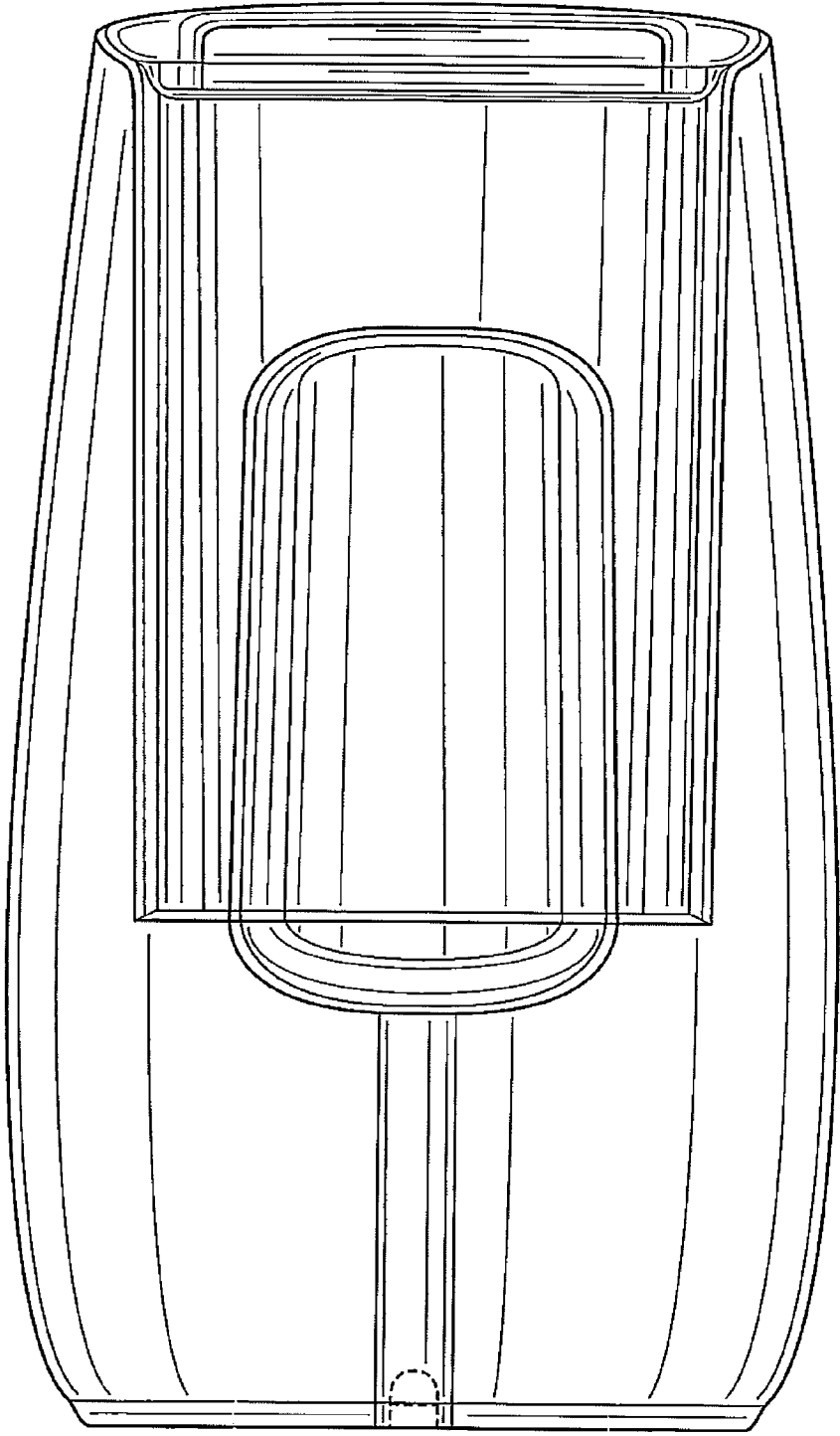

FIG. 5

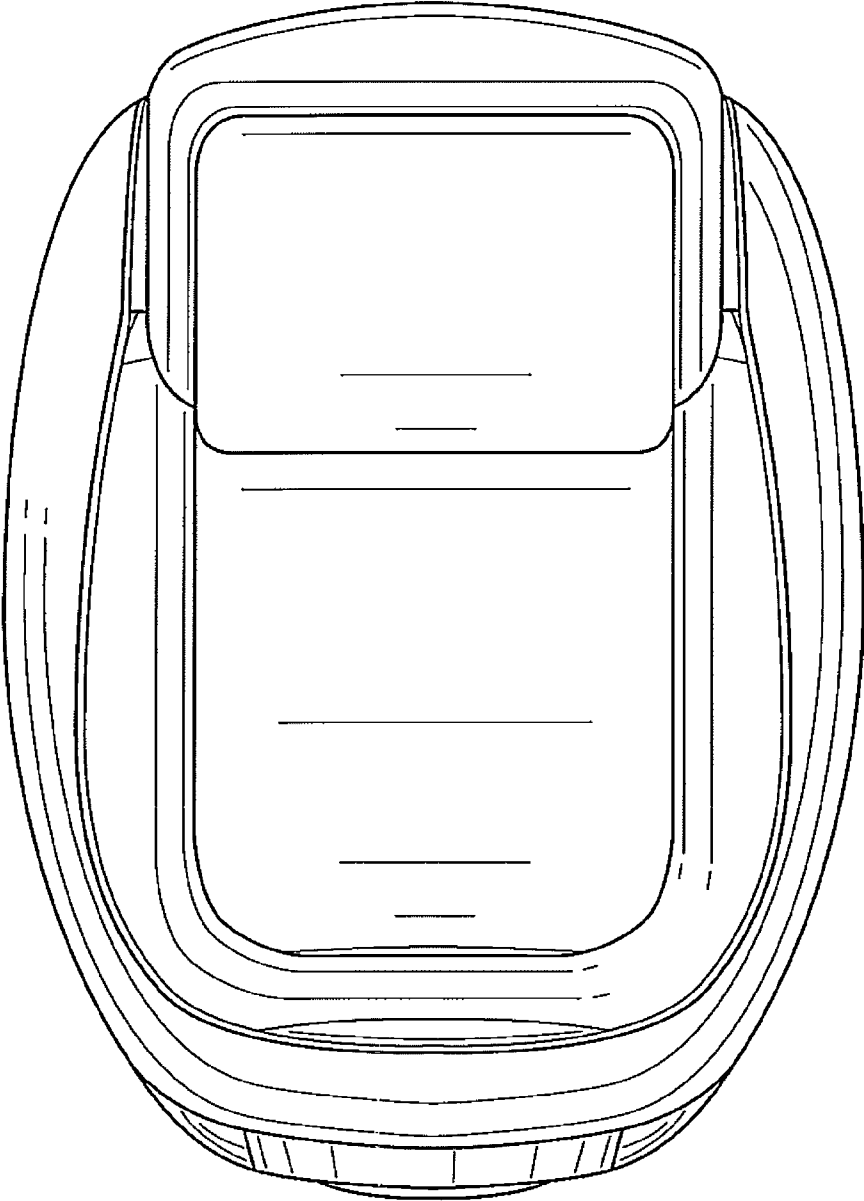

FIG. 6

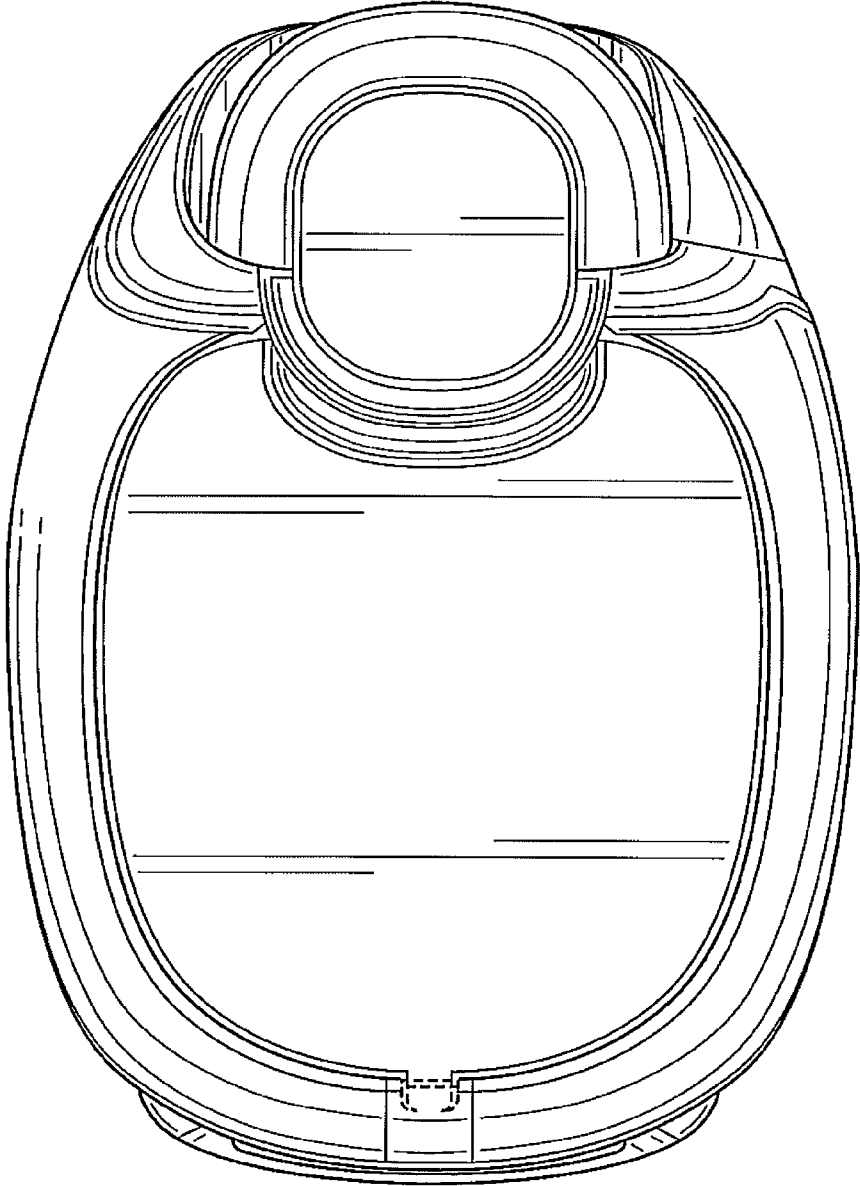

FIG. 7

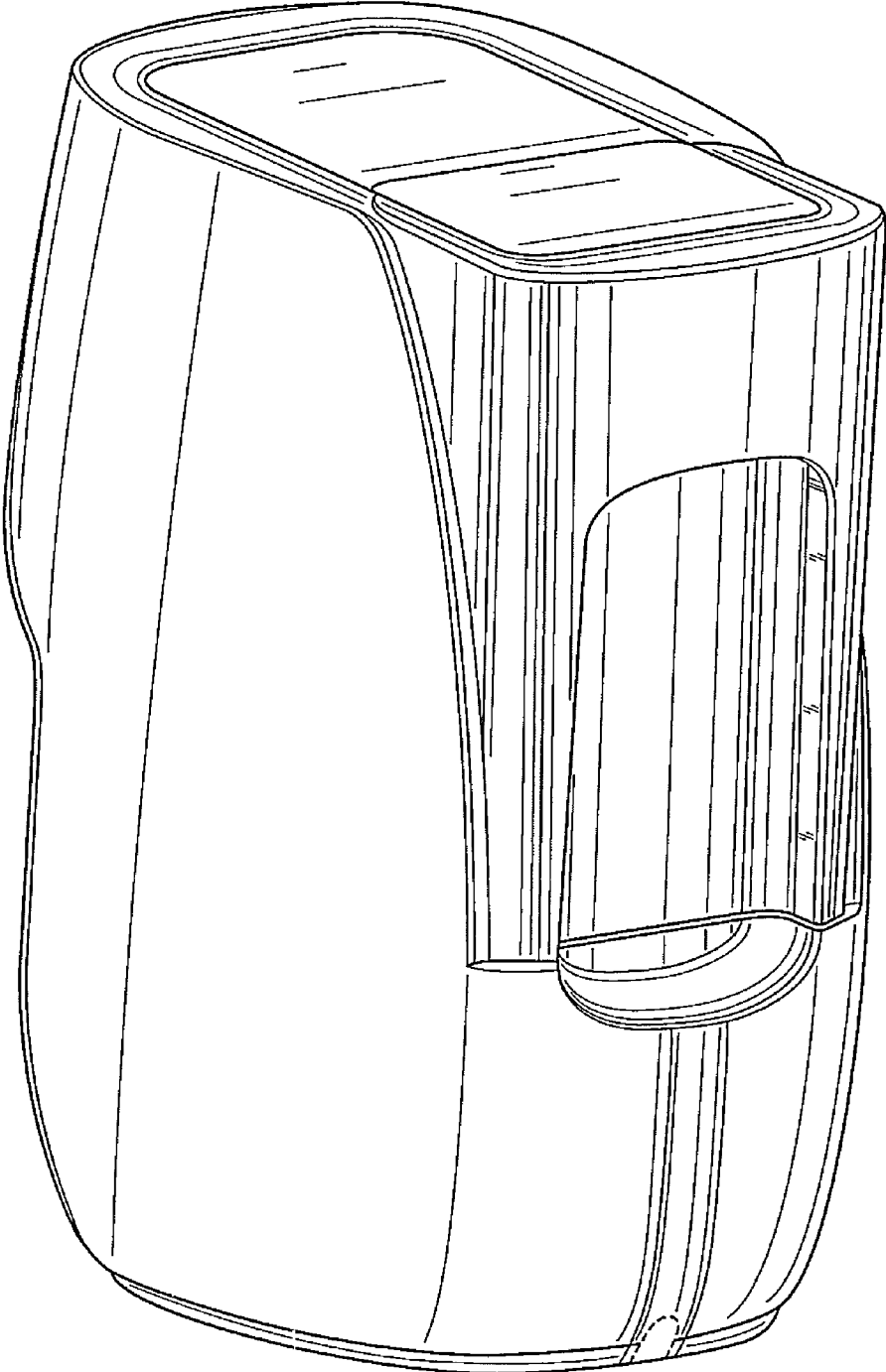

FIG. 8