



- (51) **International Patent Classification:**
A61K 8/27 (2006.01) *A61Q 17/00* (2006.01)
A61K 8/34 (2006.01)
- (21) **International Application Number:** PCT/EP2011/073293
- (22) **International Filing Date:** 19 December 2011 (19.12.2011)
- (25) **Filing Language:** English
- (26) **Publication Language:** English
- (30) **Priority Data:**
1060950 21 December 2010 (21.12.2010) FR
61/431,615 11 January 2011 (11.01.2011) US
- (71) **Applicant** (*for all designated States except US*):
L'OREAL [FR/FR]; 14, Rue Royale, F-75008 Paris (FR).
- (72) **Inventor; and**
- (75) **Inventor/Applicant** (*for US only*): **BRUN, Julie** [FR/FR];
4 Villa Armand, F-75018 Paris (FR).
- (74) **Agent:** **DOSSMANN, Gérard**; Bureau D.A. Casalonga &
Josse, 8 Avenue Percier, F-75008 Paris (FR).
- (81) **Designated States** (*unless otherwise indicated, for every kind of national protection available*): AE, AG, AL, AM, AO, AT, AU, AZ, BA, BB, BG, BH, BR, BW, BY, BZ, CA, CH, CL, CN, CO, CR, CU, CZ, DE, DK, DM, DO, DZ, EC, EE, EG, ES, FI, GB, GD, GE, GH, GM, GT, HN, HR, HU, ID, IL, IN, IS, JP, KE, KG, KM, KN, KP, KR, KZ, LA, LC, LK, LR, LS, LT, LU, LY, MA, MD, ME, MG, MK, MN, MW, MX, MY, MZ, NA, NG, NI, NO, NZ, OM, PE, PG, PH, PL, PT, QA, RO, RS, RU, RW, SC, SD, SE, SG, SK, SL, SM, ST, SV, SY, TH, TJ, TM, TN, TR, TT, TZ, UA, UG, US, UZ, VC, VN, ZA, ZM, ZW.
- (84) **Designated States** (*unless otherwise indicated, for every kind of regional protection available*): ARIPO (BW, GH, GM, KE, LR, LS, MW, MZ, NA, RW, SD, SL, SZ, TZ, UG, ZM, ZW), Eurasian (AM, AZ, BY, KG, KZ, MD, RU, TJ, TM), European (AL, AT, BE, BG, CH, CY, CZ, DE, DK, EE, ES, FI, FR, GB, GR, HR, HU, IE, IS, IT, LT, LU, LV, MC, MK, MT, NL, NO, PL, PT, RO, RS, SE, SI, SK, SM, TR), OAPI (BF, BJ, CF, CG, CI, CM, GA, GN, GQ, GW, ML, MR, NE, SN, TD, TG).
- Published:**
— *with international search report (Art. 21(3))*



WO 2012/084863 A1

(54) **Title:** COSMETIC COMPOSITION COMPRISING A ZINC SALT AND 1,2-OCTANEDIOL

(57) **Abstract:** The present invention relates to a composition comprising one or more zinc salts and 1,2-octanediol, the weight ratio of the amount of zinc salt(s) to the amount of 1,2-octanediol being strictly greater than 1, and the content of 1,2-octanediol being strictly less than 0.5% by weight, relative to the total weight of the composition. Another subject of invention relates to the use of such a composition as an antimicrobial and antifungal agent.

Cosmetic composition comprising a zinc salt and 1,2-octanediol

5 The present invention relates to a cosmetic composition comprising, in a cosmetically acceptable medium, at least one zinc salt in combination with 1,2-octanediol, in specific proportions, and to the use of such a composition for protecting against and/or combating the growth of microbes.

10 For the purpose of inhibiting the growth of moulds, yeasts, bacteria and other microbes in cosmetic compositions, preservatives are customarily used. These must be chosen with very great care so as not to inhibit the activity or be detrimental to the efficacy of the other ingredients present in the cosmetic composition. In addition, they must meet certain stability, efficacy and harmlessness criteria. In addition, they must not detract from the appearance of the cosmetic composition to
15 which they are added (browning, for example).

 Within the context of aqueous compositions comprising, as cosmetic active agents, zinc salts, such as zinc gluconate or zinc chloride for protecting for example the artificial colour of dyed hair, it was observed that it was difficult to effectively and lastingly protect such compositions against microorganisms such as yeasts,
20 bacteria, moulds, and other microbes, without being detrimental to the cosmetic properties of the composition. In particular, the microbial protection of these aqueous cosmetic compositions is difficult to achieve when they contain a low concentration of zinc salts, for example when they comprise from 0.2% to 3% by weight of zinc salts relative to the total weight of the composition.

25 Surprisingly and advantageously, the Applicant has discovered that the combination of a zinc salt with 1,2-octanediol in a specific weight ratio of zinc salt to 1,2-octanediol and a specific content of 1,2-octanediol, made it possible to improve the effectiveness and the duration of the microbial protection of aqueous cosmetic compositions, even ones that have a low concentration of zinc salts, without
30 adversely affecting the cosmetic properties of the cosmetic compositions. Moreover, this combination has the advantage of satisfying the storage stability, harmlessness and aesthetic criteria required for the successful marketing of a cosmetic product.

 One subject of the present invention is a composition comprising:

- one or more zinc salts and
- 35 - 1,2-octanediol,

the weight ratio of the amount of zinc salt to the amount of 1,2-octanediol being strictly greater than 1, and the content of 1,2-octanediol being strictly less than 0.5% by weight, relative to the total weight of the composition.

5 Another subject of the present invention consists of a method for the cosmetic treatment of keratin materials, in which a composition according to the invention is applied to the keratin materials, with or without subsequent rinsing.

Another subject of the present invention relates to the use of a composition according to the invention as an antimicrobial and antifungal agent of a cosmetic
10 composition, such as a hair or dermatological composition.

Other subjects, characteristics, aspects and advantages of the invention will become even more clearly apparent on reading the description and examples which follow.

15 The composition according to the invention comprises one or more zinc salts.

The expression "zinc salt" is understood to mean any inorganic or organic compound comprising in its structure at least one zinc-based cation and one anion resulting from an inorganic or organic acid.

20 The zinc salt(s) used according to the invention is (are) preferably chosen from water-soluble zinc salts. Preferably, the zinc salt(s) is (are) not nitrogen-containing, i.e. comprise(s) no nitrogen atom.

The expression "water-soluble zinc salt" is understood to mean any salt having a solubility in water greater than or equal to 0.5% by weight, at a temperature of 25°C.

25 The zinc salt(s) is (are) chosen from inorganic and organic zinc salts, and mixtures thereof.

The expression "inorganic zinc salt" is understood to mean any zinc salt that optionally only contains carbon in the form of carbonate or hydrogen carbonate ions.

30 Among the inorganic zinc salts that can be used, mention may be made, for example, of zinc sulphate and zinc chloride, and mixtures thereof.

Among the organic zinc salts that can be used, mention may be made, for example, of zinc lactate, zinc gluconate, zinc phenolsulphonate, zinc citrate, zinc salicylate and derivatives thereof, and mixtures thereof.

Zinc salicylate and derivatives thereof according to the invention correspond to the following structure:

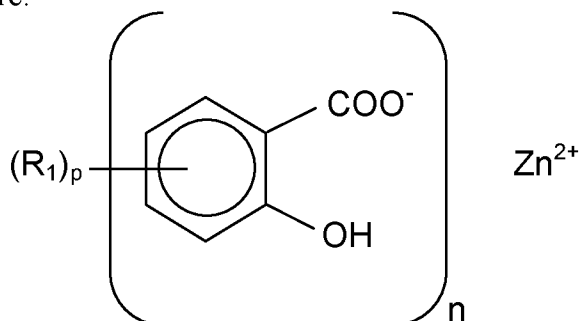

in which:

5 $n = 2$, p is equal to 0, 1, 2 or 3;

R_1 denotes a linear or branched C_1 - C_{18} alkyl group (for example methyl, ethyl, n-propyl, isopropyl, n-butyl); a linear or branched C_1 - C_{18} hydroxyalkyl group; a halogen atom (for example iodine, bromine or chlorine); a C_2 - C_{18} acyl group (for example acetyl); a COR_2 or $OCOR_2$ group, in which R_2 denotes a hydrogen atom or
10 a linear or branched C_1 - C_{18} alkyl group.

Preferably, the zinc salt(s) is (are) chosen from: zinc sulphate, zinc chloride, zinc lactate, zinc gluconate, zinc salicylate, zinc citrate, and mixtures thereof.

Better still, the zinc salt(s) is (are) chosen from: zinc sulphate, zinc chloride, zinc lactate and zinc gluconate, alone or as a mixture.

15 More preferably still, the zinc salt is an organic zinc salt. Even more preferably, the zinc salt is zinc lactate or zinc gluconate. Better still, the zinc salt is zinc gluconate.

Zinc gluconate in the composition according to the invention is sold for example under the name GIVOBIO G Zn by the company SEPPIC.

20 The composition according to the invention preferably comprises from 0.1% to 10% by weight, in particular from 0.1% to 6.5% by weight, and better still from 0.2% to 3% by weight of zinc salt(s), relative to the total weight of the composition.

The zinc element concentration is preferably less than 2% by weight, in particular ranging from 0.005% to 1.5% by weight and better still from 0.1% to 1%
25 by weight, relative to the total weight of the composition.

The composition according to the invention comprises 1,2-octanediol.

1,2-octanediol or caprylyl glycol is for example available from the company Dr STRAETMANS under the name DERMASOFT OCTIOL or by the company SYMRISE under the name 199602 HYDROLITE CG.

5 The composition according to the invention preferably comprises a concentration of 1,2-octanediol ranging from 0.001% to 0.49% by weight, in particular from 0.01% to 0.45% by weight, and better still from 0.1% to 0.45% by weight, relative to the total weight of the composition.

10 Preferably, the weight ratio of the amount of zinc salt to the amount of 1,2-octanediol varies from 1.1 to 100, in particular, this weight ratio varies from 1.1 to 50 and more preferably still from 1.1 to 10.

Preferably, the weight ratio of the amount of zinc element to the amount of 1,2-octanediol varies from 0.05 to 2.

15 The composition according to the invention may also comprise one or more additional preserving agents other than 1,2-octanediol. The preserving agent(s) is (are) preferably chosen from sodium benzoate, benzoic acid, phenoxyethanol, and mixtures thereof.

20 When the composition comprises at least one preserving agent, the amount of the additional preserving agent(s) preferably varies from 0.01% to 2% by weight, in particular from 0.05% to 0.8% by weight, and better still from 0.1% to 0.8% by weight, relative to the total weight of the composition.

The composition according to the invention may further comprise one or more surfactants selected from anionic, nonionic, zwitterionic or amphoteric, and cationic surfactants.

25 The term "anionic surfactant" means a surfactant comprising, as ionic or ionizable groups, only anionic groups. These anionic groups are preferably chosen from the following groups: CO_2H , CO_2^- , SO_3H , SO_3^- , OSO_3H , OSO_3^- , $\text{O}_2\text{PO}_2\text{H}_2$, $\text{O}_2\text{PO}_2\text{H}$, $\text{O}_2\text{PO}_2^{2-}$.

30 The anionic surfactant or surfactants which may be used in the compositions of the invention are selected in particular from alkyl sulphates, alkyl ether sulphates, alkylamido ether sulphates, alkylaryl polyether sulphates, monoglyceride sulphates, alkyl sulphonates, alkylamide sulphonates, alkylaryl sulphonates, alpha-olefin sulphonates, paraffin sulphonates, alkyl sulphosuccinates, alkyl ether sulphosuccinates, alkylamide sulphosuccinates, alkyl sulphoacetates, acyl sarcosinates, acyl glutamates, alkyl sulphosuccinamates, acyl isethionates and N-acyl

taurates, salts of alkyl monoesters of polyglycoside-polycarboxylic acids, acyl lactylates, D-galactoside-uronic acid salts, alkyl ether carboxylic acid salts, alkylaryl ether carboxylic acid salts, alkylamido ether carboxylic acid salts; or the non-salified forms of all these compounds, the alkyl and acyl groups of all these compounds
5 comprising from 6 to 24 carbon atoms and the aryl group denoting a phenyl group.

Some of these compounds may be oxyethylenated and then preferably comprise from 1 to 50 ethylene oxide units.

The salts of C₆₋₂₄ alkyl monoesters of polyglycoside-polycarboxylic acids may be chosen from C₆₋₂₄ alkyl polyglycoside citrates, C₆₋₂₄ alkyl polyglycoside tartrates and C₆₋₂₄ alkyl polyglycoside sulphosuccinates.
10

When the anionic surfactant(s) is (are) in salt form, they are not in the form of zinc salts, and it (they) may be chosen from alkali metal salts, such as the sodium or potassium salt, and preferably the sodium salt, ammonium salts, amine salts, and in particular amino alcohol salts, and alkaline-earth metal salts such as the magnesium salt.
15

Examples of amino alcohol salts that may especially be mentioned include monoethanolamine, diethanolamine and triethanolamine salts, monoisopropanolamine, diisopropanolamine or triisopropanolamine salts, 2-amino-2-methyl-1-propanol salts, 2-amino-2-methyl-1,3-propanediol salts and tris(hydroxymethyl)aminomethane salts.
20

Alkali metal or alkaline-earth metal salts, and in particular sodium or magnesium salts, are preferably used.

Use is preferably made of (C₆₋₂₄)alkyl sulphates, (C₆₋₂₄)alkyl ether sulphates, which are optionally ethoxylated, comprising from 2 to 50 ethylene oxide units, and mixtures thereof, in particular in the form of alkali metal salts or alkaline-earth metal salts, ammonium salts or amino alcohol salts. More preferentially, the anionic surfactant(s) is (are) chosen from (C₁₀₋₂₀)alkyl ether sulphates, and in particular sodium lauryl ether sulphate containing 2.2 mol of ethylene oxide.
25

When they are present, the amount of the anionic surfactant(s) varies preferably from 0.1% to 50% by weight, better still from 4% to 30% by weight, relative to the total weight of the composition.
30

Examples of nonionic surfactants that may be used in the cosmetic composition according to the invention are described, for example, in the "Handbook of Surfactants" by M.R. Porter, published by Blackie & Son (Glasgow and London),

1991, pp. 116-178. They are chosen, in particular, from alcohols, α -diols and (C₁₋₂₀)alkylphenols, these compounds being polyethoxylated, polypropoxylated and/or polyglycerolated and having at least one fatty chain comprising, for example, from 8 to 18 carbon atoms, it being possible for the number of ethylene oxide and/or propylene oxide groups to range, in particular, from 2 to 50, and it being possible for the number of glycerol groups to range, in particular, from 2 to 30.

Mention may also be made of copolymers of ethylene oxide and of propylene oxide, optionally oxyethylenated sorbitan fatty acid esters, saccharose fatty acid esters, polyoxyalkylenated fatty acid esters, optionally oxyalkylenated alkyl polyglycosides, alkyl glucoside esters, derivatives of N-alkyl glucamine and of N-acyl methylglucamine, aldobionamides and amine oxides.

Unless otherwise mentioned, the term "fatty" compound (for example a fatty acid) denotes a compound comprising, in its main chain, at least one saturated or unsaturated alkyl chain containing at least 8 carbon atoms, preferably from 8 to 30 carbon atoms, and better still from 10 to 22 carbon atoms.

When they are present, the amount of the nonionic surfactant(s) varies preferably from 0.01% to 20% by weight, better still from 0.2% to 10% by weight, relative to the total weight of the composition.

The amphoteric or zwitterionic surfactant(s) that can be used in the present invention may especially be optionally quaternized secondary or tertiary aliphatic amine derivatives, in which the aliphatic group is a linear or branched chain containing from 8 to 22 carbon atoms, said amine derivatives containing at least one anionic group such as, for example, a carboxylate, sulphonate, sulphate, phosphate or phosphonate group. Mention may be made in particular of (C₈-C₂₀)alkylbetaines, sulphobetaines, (C₈-C₂₀ alkyl)amido(C₃₋₈ alkyl)betaines or (C₈-C₂₀ alkyl)amido(C₆-C₈ alkyl)sulphobetaines. Among the optionally quaternized derivatives of secondary or tertiary aliphatic amines that can be used, as defined above, mention may also be made of the compounds with respective structures (I) and (II) below:



in which:

Ra represents a C₁₀-C₃₀ alkyl or alkenyl group derived from an acid Ra-COOH preferably present in hydrolysed coconut oil, a heptyl, nonyl group or undecyl group

Rb represents a β -hydroxyethyl group, and
 Rc represents a carboxymethyl group;

and

5 Ra'-CONHCH₂CH₂-N(B)(B') (II)

in which:

B represents -CH₂CH₂OX',

B' represents -(CH₂)_z-Y', with z = 1 or 2,

10 X' represents the group -CH₂-COOH, CH₂-COOZ', -CH₂CH₂-COOH, -
 CH₂CH₂-COOZ', or a hydrogen atom,

Y' represents -COOH, -COOZ' or the group -CH₂-CHOH-SO₃H or -CH₂-
 CHOH-SO₃Z',

15 Z' represents an ion derived from an alkali metal or alkaline-earth metal, such
 as sodium, an ammonium ion or an ion derived from an organic amine,

Ra' represents a C₁₀-C₃₀ alkyl or alkenyl group of an acid Ra'-COOH which is
 preferably present in hydrolysed linseed oil or coconut oil, or an alkyl group, especially
 a C₁₇ group, and its iso form, or an unsaturated C₁₇ group.

20 These compounds are classified in the CTFA dictionary, 5th edition, 1993,
 under the names disodium cocoamphodiacetate, disodium lauroamphodiacetate,
 disodium caprylamphodiacetate, disodium capryloamphodiacetate, disodium
 cocoamphodipropionate, disodium lauroamphodipropionate, disodium
 caprylamphodipropionate, disodium capryloamphodipropionate,
 lauroamphodipropionic acid and cocoamphodipropionic acid.

25 By way of example, mention may be made of the cocoamphodiacetate sold by
 the company Rhodia under the trade name Miranol[®] C2M Concentrate.

30 Among the abovementioned amphoteric or zwitterionic surfactants, use is
 preferably made of (C₈-C₂₀ alkyl)betaines such as cocoylbetaine, and (C₈-C₂₀
 alkyl)amido(C₂-C₈ alkyl)betaines such as cocoylamidopropylbetaine, and mixtures
 thereof. More preferably, the amphoteric or zwitterionic surfactant(s) is (are) chosen
 from cocoylamidopropylbetaine and cocoylbetaine.

When they are present, the amount of the amphoteric or zwitterionic
 surfactant(s) is preferably in the range from 0.01% to 20% by weight, better still from
 0.5% to 10% by weight, relative to the total weight of the composition.

The term "cationic surfactant" means a surfactant that is positively charged when it is contained in the composition according to the invention. This surfactant may bear one or more positive permanent charges or may contain one or more functions that are cationizable in the composition according to the invention.

5 The cationic surfactant(s) that may be used as conditioning agents according to the present invention are preferably selected from optionally polyoxyalkylenated primary, secondary or tertiary fatty amines, or the salts thereof, quaternary ammonium salts, and mixtures thereof.

10 The fatty amines generally comprise at least one C₈-C₃₀ hydrocarbon-based chain. Among the fatty amines that can be used according to the invention, examples that may be mentioned include stearylamidopropyldimethylamine and distearylamine.

Examples of quaternary ammonium salts that may especially be mentioned include:

15 - those corresponding to the general formula (III) below:

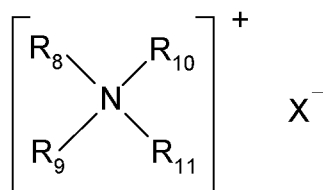

(III)

20 in which the radicals R₈ to R₁₁, which may be identical or different, represent an aromatic radical such as aryl or alkylaryl or a linear or branched aliphatic radical comprising from 1 to 30 carbon atoms, at least one of the radicals R₈ to R₁₁ denoting an alkyl or alkenyl radical comprising from 8 to 30 carbon atoms, preferably from 14 to 30 carbon atoms and better still from 16 to 25 carbon atoms. The aliphatic groups may comprise heteroatoms such as, in particular, oxygen, nitrogen, sulphur and halogens. The aliphatic groups are selected, for example, from C₁₋₃₀ alkyl, C₁₋₃₀ alkoxy, polyoxyalkylene (C₂-C₆), C₁₋₃₀ alkylamide, (C₁₂-C₂₂)alkylamido(C₂-C₆)alkyl, (C₁₂-C₂₂)alkylacetate, and C₁₋₃₀ hydroxyalkyl groups; X⁻ is an anion selected from the group of halides, phosphates, acetates, lactates, (C₁-C₄)alkyl sulphates and (C₁-C₄)alkyl sulphonates or (C₁-C₄)alkylaryl sulphonates.

25 Among the quaternary ammonium salts of formula (III), those that are preferred are, on the one hand, tetraalkylammonium salts, for instance dialkyl-dimethylammonium or alkyltrimethylammonium salts in which the alkyl group
30

contains approximately from 12 to 22 carbon atoms, in particular behenyltrimethylammonium, distearyldimethylammonium, cetyltrimethylammonium or benzyl-
 dimethylstearylammonium salts, or, on the other hand, the palmitylamidopropyl-
 trimethylammonium salt, the stearamidopropyltrimethylammonium salt, the
 5 stearamidopropyldimethylcetarylammonium salt, or the stearamidopropyldimethyl-
 (myristyl acetate)ammonium salt sold under the name Ceraphyl® 70 by the company
 Van Dyk. It is particularly preferred to use the chloride salts of these compounds;

- quaternary ammonium salts of imidazoline, such as, for example, those of
 formula (IV) below:

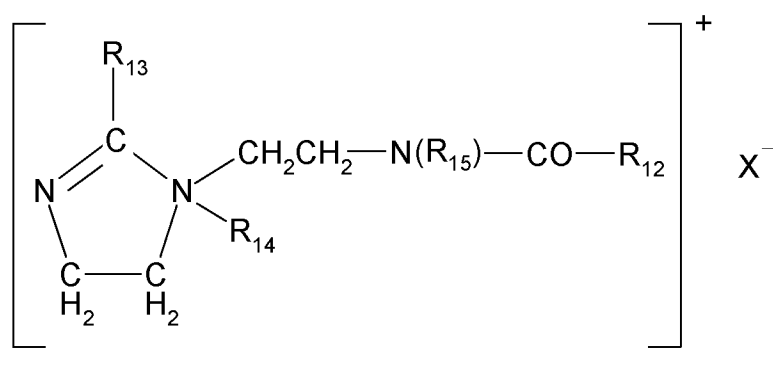

10

15

20

in which R₁₂ represents an alkenyl or alkyl group containing from 8 to 30
 carbon atoms, for example tallow fatty acid derivatives, R₁₃ represents a hydrogen
 atom, a C₁-C₄ alkyl group or an alkenyl or alkyl group containing from 8 to 30
 carbon atoms, R₁₄ represents a C₁-C₄ alkyl group, R₁₅ represents a hydrogen atom or
 a C₁-C₄ alkyl group, X⁻ is an anion chosen from the group of halides, phosphates,
 acetates, lactates, alkyl sulphates, alkyl sulphonates or alkylaryl sulphonates, the
 alkyl and aryl groups of which preferably comprise, respectively, from 1 to 20 carbon
 atoms and from 6 to 30 carbon atoms. R₁₂ and R₁₃ preferably denote a mixture of
 alkenyl or alkyl groups comprising from 12 to 21 carbon atoms, for example tallow
 fatty acid derivatives, R₁₄ denotes a methyl group, and R₁₅ denotes a hydrogen atom.
 Such a product is sold, for example, under the name Rewoquat® W 75 by the
 company Rewo;

- quaternary diammonium or triammonium salts, in particular of formula
 (V):

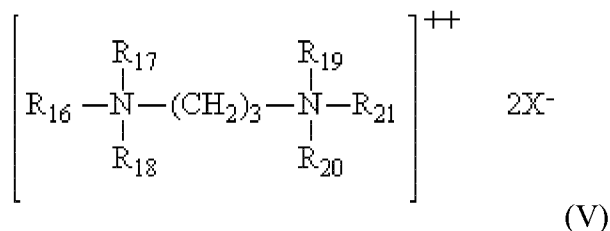

in which R₁₆ denotes an alkyl radical containing approximately from 16 to 30 carbon atoms, which is optionally hydroxylated and/or interrupted with one or more oxygen atoms, R₁₇ is selected from hydrogen or an alkyl radical containing from 1 to 4 carbon atoms or a group (R_{16a})(R_{17a})(R_{18a})N-(CH₂)₃, R_{16a}, R_{17a}, R_{18a}, R₁₈, R₁₉, R₂₀ and R₂₁, which may be identical or different, are selected from hydrogen or an alkyl radical containing from 1 to 4 carbon atoms, and X⁻ is an anion selected from the group of halides, acetates, phosphates, nitrates and methyl sulphates. Such compounds are, for example, Finquat CT-P, available from the company Finetex (Quaternium 89), and Finquat CT, available from the company Finetex (Quaternium 75),

- quaternary ammonium salts containing at least one ester function, such as those of formula (VI) below:

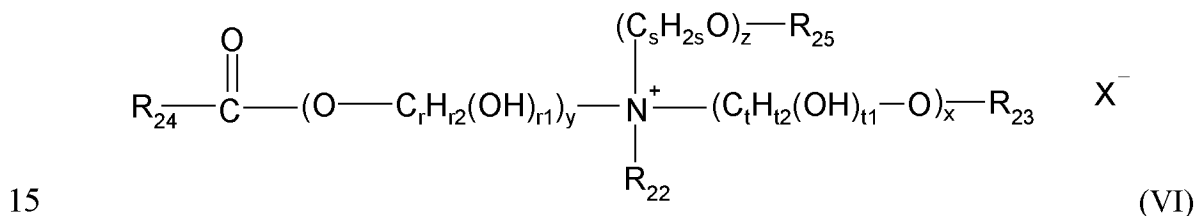

in which:

R₂₂ is chosen from C₁-C₆ alkyl groups and C₁-C₆ hydroxyalkyl or dihydroxyalkyl groups;

R₂₃ is selected from:

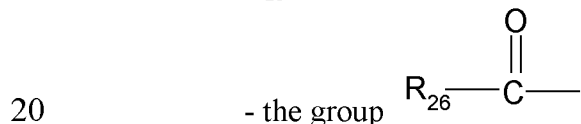

- groups R₂₇ which are linear or branched, saturated or unsaturated C₁-C₂₂ hydrocarbon-based groups,

- a hydrogen atom,

R₂₅ is selected from:

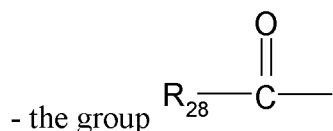

- groups R_{29} which are linear or branched, saturated or unsaturated $\text{C}_1\text{-C}_6$ hydrocarbon-based groups,
 - a hydrogen atom,
- 5 R_{24} , R_{26} and R_{28} , which may be identical or different, are chosen from linear or branched, saturated or unsaturated $\text{C}_7\text{-C}_{21}$ hydrocarbon-based groups;
- r , s and t , which may be identical or different, are integers ranging from 2 to 6;
- r_1 and t_1 , which may be identical or different, are equal to 0 or 1, and
- 10 r_2 and t_2 are integers such that $r_2+r_1=2r$ and $t_1+t_2=2t$;
- y is an integer ranging from 1 to 10;
- x and z , which may be identical or different, are integers ranging from 0 to 10;
- X^- is a simple or complex, organic or inorganic anion;
- 15 with the proviso that the sum $x + y + z$ is from 1 to 15, that when x is 0, then R_{23} denotes R_{27} and that when z is 0, then R_{25} denotes R_{29} .
- The alkyl groups R_{22} may be linear or branched, and more particularly linear.
- Preferably, R_{22} denotes a methyl, ethyl, hydroxyethyl or dihydroxypropyl
- 20 group, and more particularly a methyl or ethyl group.
- Advantageously, the sum $x + y + z$ is from 1 to 10.
- When R_{23} is a hydrocarbon-based group R_{27} , it may be long and contain from 12 to 22 carbon atoms, or may be short and contain from 1 to 3 carbon atoms.
- When R_{25} is a hydrocarbon-based group R_{29} , it preferably contains 1 to 3
- 25 carbon atoms.
- Advantageously, R_{24} , R_{26} and R_{28} , which may be identical or different, are chosen from linear or branched, saturated or unsaturated $\text{C}_{11}\text{-C}_{21}$ hydrocarbon-based groups, and more particularly from linear or branched, saturated or unsaturated $\text{C}_{11}\text{-C}_{21}$ alkyl and alkenyl groups.
- 30 Preferably, x and z , which may be identical or different, are equal to 0 or 1.
- Advantageously, y is equal to 1.

Preferably, r, s and t, which may be identical or different, are equal to 2 or 3, and even more particularly are equal to 2.

The anion X^- is preferably a halide (chloride, bromide or iodide) or an alkyl sulphate, more particularly methyl sulphate. However, it is possible to use
 5 methanesulphonate, phosphate, nitrate, tosylate, an anion derived from an organic acid, such as acetate or lactate, or any other anion that is compatible with the ammonium containing an ester function.

The anion X^- is even more particularly chloride or methyl sulphate.

Use is made more particularly, in the composition according to the
 10 invention, of the ammonium salts of formula (VI) in which:

R_{22} denotes a methyl or ethyl group,

x and y are equal to 1;

z is equal to 0 or 1;

r, s and t are equal to 2; with r1, r2, t1 and t2 being as defined previously;

15 - X^- being as defined previously;

R_{23} is selected from:

- the group $R_{26}-\overset{\text{O}}{\parallel}{\text{C}}$

- methyl, ethyl or C_{14} - C_{22} hydrocarbon-based groups;

- a hydrogen atom;

20 R_{25} is selected from:

- the group $R_{28}-\overset{\text{O}}{\parallel}{\text{C}}$

- a hydrogen atom;

R_{24} , R_{26} and R_{28} , which may be identical or different, are chosen from linear
 or branched, saturated or unsaturated C_{13} - C_{17} hydrocarbon-based groups, and
 25 preferably from linear or branched, saturated or unsaturated C_{13} - C_{17} alkyl and alkenyl groups.

The hydrocarbon-based groups are advantageously linear.

Mention may be made, for example, of the compounds of formula (VI) such
 as the diacyloxyethylmethylammonium, diacyloxyethylhydroxyethylmethyl-
 30 ammonium, monoacyloxyethyldihydroxyethylmethylammonium, triacyloxyethyl-

methyllummonium and monoacyloxyethylhydroxyethyl-dimethylammonium salts (chloride or methyl sulphate in particular), and mixtures thereof. The acyl groups preferably contain 14 to 18 carbon atoms and are obtained more particularly from a plant oil such as palm oil or sunflower oil. When the compound contains several acyl groups, these groups may be identical or different.

These products are obtained, for example, by direct esterification of triethanolamine, of triisopropanolamine, of alkyldiethanolamine or of alkyldiisopropanolamine, which are optionally alkoxyated, with C₁₀-C₃₀ fatty acids or with mixtures of C₁₀-C₃₀ fatty acids of plant or animal origin, or by transesterification of their methyl esters. This esterification is followed by a quaternization using an alkylating agent such as an alkyl halide (preferably a methyl or ethyl halide), a dialkyl sulphate (preferably a dimethyl or diethyl sulphate), methyl methanesulphonate, methyl *para*-toluenesulphonate, glycol chlorohydrin or glycerol chlorohydrin.

Such compounds are sold, for example, under the names Dehyquat® by the company Henkel, Stepanquat® by the company Stepan, Noxamium® by the company Ceca or Rewoquat® WE 18 by the company Rewo-Witco.

The composition according to the invention may contain, for example, a mixture of quaternary ammonium monoester, diester and triester salts with a majority by weight of diester salts.

Mixtures of ammonium salts that may be used include, for example, the mixture containing 15% to 30% by weight of acyloxyethyl-dihydroxyethyl-methylammonium methyl sulphate, 45% to 60% by weight of diacyloxyethylhydroxyethyl-methylammonium methyl sulphate and 15% to 30% by weight of triacyloxyethyl-methylammonium methyl sulphate, the acyl groups having from 14 to 18 carbon atoms and originating from palm oil, which is optionally partially hydrogenated.

It is also possible to use the ammonium salts containing at least one ester function that are described in patents US-A-4 874 554 and US-A-4 137 180.

Use may be made of behenoyl-hydroxy-propyl-trimethylammonium chloride sold by KAO under the name Quatarmin BTC 131.

Preferably, the ammonium salts containing at least one ester function contain two ester functions.

Among the quaternary ammonium salts containing at least one ester function, which can be used, it is preferred to use dipalmitoylethylhydroxyethylmethylammonium salts.

5 When they are present, the amount of the cationic surfactant(s) is preferably in the range from 0.01% to 20% by weight and better still from 0.5% to 10% by weight, relative to the total weight of the composition.

The composition according to the invention may also comprise one or more fatty alcohols.

10 For the purposes of the present invention, the term "fatty alcohol" means any saturated or unsaturated, linear or branched pure fatty alcohol that contains at least 8 carbon atoms and that does not contain oxyalkylenated or glycerolated groups.

The fatty alcohol may have the structure R-OH in which R denotes a saturated or unsaturated, linear or branched radical containing from 8 to 40 and preferably from 8 to 30 carbon atoms; R preferably denotes a C₁₂-C₂₄ alkyl or C₁₂-C₂₄ 15 alkenyl group. R may be substituted with one or more hydroxyl groups.

Examples of fatty alcohols that may be mentioned include lauryl alcohol, myristyl alcohol, cetyl alcohol, dodecyl alcohol, decyl alcohol, stearyl alcohol, oleyl alcohol, behenyl alcohol, linoleyl alcohol, undecylenyl alcohol, palmitoleyl alcohol, arachidonyl alcohol and erucyl alcohol, and mixtures thereof.

20 The fatty alcohol may represent a mixture of fatty alcohols, which means that several species of fatty alcohol may coexist, in the form of a mixture, in a commercial product.

Fatty alcohol mixtures that may be mentioned include cetylstearyl alcohol and cetearyl alcohol.

25 Among all the fatty alcohols that can be used according to the invention, use is preferably made of one or more fatty alcohols chosen from cetyl alcohol, stearyl alcohol and myristyl alcohol.

30 If present, the composition according to the invention may comprise preferably from 0.1% to 10% by weight and better still from 1% to 5% by weight of fatty alcohol(s) relative to the total weight of the composition.

The composition according to the invention may also comprise one or more fatty alcohol and/or fatty acid esters.

As fatty alcohol and/or fatty acid esters that can be used, mention may be made of the esters resulting from the esterification reaction of a fatty alcohol as defined above and/or of a fatty acid as defined below.

5 For the purposes of the present invention, the term "fatty acid" means any saturated or unsaturated, linear or branched pure carboxylic acid that contains at least 8 carbon atoms and that does not contain oxyalkylenated or glycerolated groups.

Examples of fatty acids that may be mentioned include lauric acid, oleic acid, palmitic acid and stearic acid.

10 Among all the fatty alcohol and/or fatty acid esters that can be used according to the invention, use is preferably made of the cetyl ester or stearyl ester, and better still a mixture thereof, as sold for example under the name Crodamol MS-Pa by the company Croda.

15 If present, the composition according to the invention may comprise preferably from 0.01% to 8% by weight and better still from 0.5% to 5% by weight of fatty alcohol and/or acid ester(s) relative to the total weight of the composition.

The composition according to the invention may also comprise one or more non-silicone cationic polymers.

20 The cationic polymer(s) that can be used in accordance with the present invention may be selected from all of those already known *per se* to enhance the cosmetic properties of hair treated with detergent compositions, these being, in particular, the polymers described in patent application EP-A-0 337 354 and in French patent applications FR-A-2 270 846, FR-A-2 383 660, FR-A-2 598 611, FR-A-2 470 596, FR-A-2 519 863 and FR-A-2 875 503.

25 The preferred cationic polymer(s) is (are) chosen from those that contain in their structure units comprising primary, secondary, tertiary and/or quaternary amine groups that may for example either form part of the main polymer chain or may be borne by a side substituent directly connected thereto.

30 Among the cationic polymers that may be mentioned more particularly are polymers from the family of polyamines, polyaminoamides and polyquaternary ammoniums. Among these polymers, mention may be made of:

(1) Crosslinked or uncrosslinked homopolymers or copolymers derived from acrylic or methacrylic esters or amides and comprising at least one of the units of formula (VII), (VIII), (IX) or (X) below:

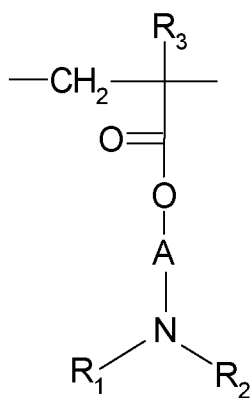

(VII)

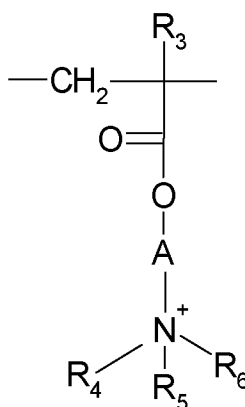

(VIII)

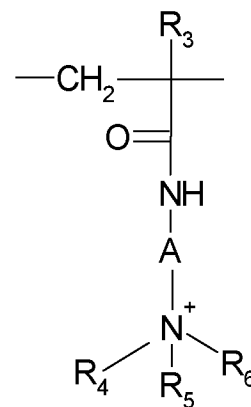

(IX)

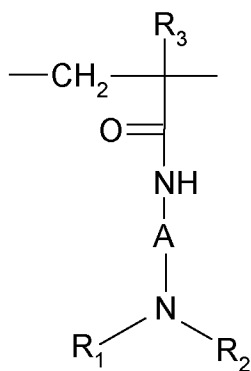

(X)

5

in which

R₁ and R₂, which are identical or different, each represent a hydrogen atom or an alkyl group having from 1 to 6 carbon atoms, and preferably methyl or ethyl;

10 R₃, which may be identical or different, each denote a hydrogen atom or a CH₃ group;

A, which may be identical or different, each represent a linear or branched alkyl group having from 1 to 6 carbon atoms, preferably 2 or 3 carbon atoms, or a hydroxyalkyl group having 1 to 4 carbon atoms;

15 R₄, R₅ and R₆, which are identical or different, each represent an alkyl group having from 1 to 6 carbon atoms or a benzyl group, and preferably an alkyl group having from 1 to 6 carbon atoms;

X⁻ denotes an anion derived from a mineral or organic acid, such as a methosulphate anion or a halide such as chloride or bromide.

The polymers of family (1) can also contain one or more units derived from comonomers which may be chosen from the family of acrylamides, methacrylamides, diacetone acrylamides, acrylamides and methacrylamides substituted on the nitrogen with lower (C₁-C₄) alkyls, acrylic or methacrylic acids or esters thereof, vinyl lactams such as vinylpyrrolidone or vinylcaprolactam, and vinyl esters.

Thus, among these polymers of family (1), mention may be made of:

- copolymers of acrylamide and of dimethylaminoethyl methacrylate quaternized with dimethyl sulphate or with a dimethyl halide, such as the product sold under the name Hercofloc by the company Hercules,
- copolymers of acrylamide and of methacryloyloxyethyltrimethylammonium chloride which are described, for example, in patent application EP-A-080976 and are sold under the name Bina Quat P 100 by the company Ciba Geigy,
- the copolymer of acrylamide and of methacryloyloxyethyltrimethylammonium methosulphate sold under the name Reten by the company Hercules,
- quaternized or non-quaternized vinylpyrrolidone/dialkylaminoalkyl acrylate or methacrylate copolymers, such as the products sold under the name Gafquat by the company ISP, such as, for example, Gafquat 734 or Gafquat 755 (Polyquaternium-11), or alternatively the products known as Copolymer 845, 958 and 937. These polymers are described in detail in French patents 2 077 143 and 2 393 573. Polyquaternium-11 is preferably used.
- dimethylaminoethyl methacrylate/vinyl-caprolactam/vinyl-pyrrolidone terpolymers, such as the product sold under the name Gaffix VC 713 by the company ISP,
- vinylpyrrolidone/methacrylamidopropyl dimethylamine copolymers sold in particular under the name Styleze CC 10 by ISP,
- quaternized vinylpyrrolidone/dimethylaminopropylmethacrylamide copolymers such as the product sold under the name Gafquat HS 100 by the company ISP,
- crosslinked polymers of methacryloyloxy(C₁-C₄)alkyl(C₁-C₄)trialkylammonium salts, such as the polymers obtained by homopolymerization of dimethylaminoethyl methacrylate quaternized with methyl chloride, or by copolymerization of acrylamide with dimethylaminoethyl methacrylate quaternized

with methyl chloride, the homopolymerization or copolymerization being followed by crosslinking with a compound comprising an olefinic unsaturation, in particular methylenebisacrylamide. A crosslinked acrylamide/methacryloyloxyethyltrimethylammonium chloride copolymer (20/80 by weight) in the form of a dispersion containing 50% by weight of the said copolymer in mineral oil can be used more particularly. This dispersion is sold under the name Salcare® SC 92 by the company Ciba. Use may also be made of a crosslinked homopolymer of methacryloyloxyethyltrimethylammonium chloride containing approximately 50% by weight of the homopolymer in mineral oil or in a liquid ester. These dispersions are sold under the names Salcare® SC 95 and Salcare® SC 96 by the company Ciba.

(2) Cationic polysaccharides in particular chosen from:

a) cellulose ether derivatives comprising quaternary ammonium groups described in French patent 1 492 597, and in particular the polymers sold under the names "JR" (JR 400, JR 125, JR 30M) or "LR" (LR 400, LR 30M) by the company Union Carbide Corporation. These polymers are also defined in the CTFA dictionary as quaternary ammoniums of hydroxyethyl cellulose that have reacted with an epoxide substituted with a trimethylammonium group,

b) the cellulose copolymers or the cellulose derivatives grafted with a water-soluble quaternary ammonium monomer such as hydroxyalkyl celluloses, for instance hydroxymethyl, hydroxyethyl or hydroxypropyl celluloses grafted especially with a methacryloyloxyethyltrimethylammonium, methacrylamidopropyltrimethylammonium or dimethyldiallylammonium salt.

The commercial products corresponding to this definition are more particularly the products, corresponding to the INCI name Polyquaternium-4, sold under the names Celquat L 200 and Celquat H 100 by the company National Starch or Celquat LOR by the company Akzo Nobel.

c) guar gums containing cationic trialkylammonium groups. Use is made, for example, of guar gums modified with a 2,3-epoxypropyltrimethylammonium salt (for example, a chloride salt).

Such products are sold in particular under the trade names Jaguar C13 S, Jaguar C 15, Jaguar C 17 or Jaguar C162 by the company Meyhall.

(3) Polymers formed from piperazinyl units and divalent alkylene or hydroxyalkylene radicals containing straight or branched chains, optionally interrupted with oxygen, sulphur or nitrogen atoms or with aromatic or heterocyclic

rings, and also the oxidation and/or quaternization products of these polymers. Such polymers are described, in particular, in French patents 2 162 025 and 2 280 361.

(4) Water-soluble cationic polyaminoamides prepared in particular by polycondensation of an acidic compound with a polyamine; these polyaminoamides can be crosslinked with an epihalohydrin, a diepoxide, a saturated or unsaturated dianhydride, a bis-unsaturated derivative, a bis-halohydrin, a bis-azetidinium, a bis-haloacyldiamine, a bis-alkyl halide or alternatively with an oligomer resulting from the reaction of a difunctional compound which is reactive with a bis-halohydrin, a bis-azetidinium, a bis-haloacyldiamine, a bis-alkyl halide, an epihalohydrin, a diepoxide or a bis-unsaturated derivative; these polyaminoamides may be alkylated or, if they contain one or more tertiary amine functions, they may be quaternized. Such polymers are described, in particular, in French patents 2 252 840 and 2 368 508.

(5) Polyamino amide derivatives resulting from the condensation of polyalkylene polyamines with polycarboxylic acids followed by alkylation with difunctional agents. Mention may be made, for example, of adipic acid/dialkylamino-hydroxyalkyldialkylenetriamine polymers in which the alkyl group contains from 1 to 4 carbon atoms and preferably denotes methyl, ethyl or propyl. Such polymers are especially described in French patent 1 583 363.

Among these derivatives, mention may be made more particularly of the adipic acid / dimethylaminohydroxypropyl/diethylenetriamine polymers sold under the name Cartaretine F, F4 or F8 by the company Sandoz.

(6) Polymers obtained by reaction of a polyalkylene polyamine containing two primary amine groups and at least one secondary amine group with a dicarboxylic acid chosen from diglycolic acid and saturated aliphatic dicarboxylic acids having from 3 to 6 carbon atoms. The molar ratio between the polyalkylene polyamine and the dicarboxylic acid is between 0.8:1 and 1.4:1; the polyaminoamide resulting therefrom is reacted with epichlorohydrin in a molar ratio of epichlorohydrin relative to the secondary amine group of the polyaminoamide of between 0.5:1 and 1.8:1. Such polymers are described in particular in US patents 3 227 615 and 2 961 347.

Polymers of this type are sold in particular under the name Hercosett 57 by the company Hercules Inc. or alternatively under the name PD 170 or Delsette 101 by

the company Hercules in the case of the adipic acid/epoxypropyl/diethylenetriamine copolymer.

(7) Alkyldiallylamine or dialkyldiallylammonium cyclopolymers, such as the homopolymers or copolymers containing, as the main constituent of the chain, units corresponding to formula (XI) or (XII):

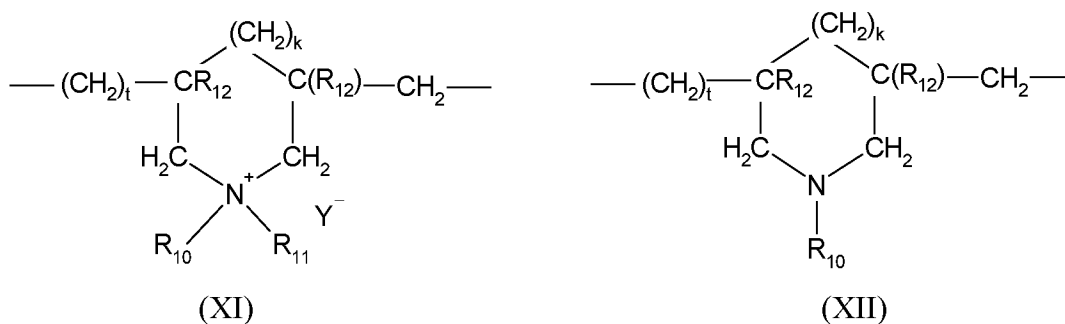

in which k and t are equal to 0 or 1, the sum $k + t$ being equal to 1; R_{12} denotes a hydrogen atom or a methyl group; R_{10} and R_{11} , each denote, independently of one another, an alkyl group having from 1 to 6 carbon atoms, a hydroxyalkyl group in which the alkyl group preferably has 1 to 5 carbon atoms, a lower amidoalkyl group (i.e. the alkyl part of which is a C_1 - C_4 alkyl), or else R_{10} and R_{11} may, together with the nitrogen atom to which they are attached, denote a heterocyclic group, such as piperidyl or morpholinyl; Y^- is an anion such as bromide, chloride, acetate, borate, citrate, tartrate, bisulphate, bisulphite, sulphate or phosphate. These polymers are especially described in French patent 2 080 759 and in its Certificate of Addition 2 190 406.

Preferably, R_{10} and R_{11} each denote, independently of one another, an alkyl group having from 1 to 4 carbon atoms.

Among the polymers defined above, mention may be made of the dialkyldiallylammonium chloride homopolymers, more particularly the dimethyldiallylammonium chloride homopolymer (INCI name: Polyquaternium-6) sold for example under the name Merquat® 100 by the company NALCO (and its homologues of low weight-average molecular weight) and the dialkyldiallylammonium chloride copolymers, more particularly the copolymer of dimethyldiallylammonium chloride and acrylamide sold in particular under the name Merquat® 550.

(8)The quaternary diammonium polymers containing repeating units corresponding to formula (XIII):

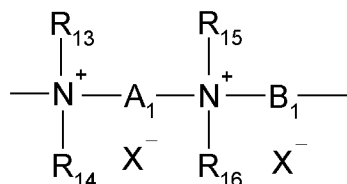

5

(XIII)

in which:

R_{13} , R_{14} , R_{15} and R_{16} , which may be identical or different, represent aliphatic, alicyclic or arylaliphatic groups containing from 1 to 6 carbon atoms or lower hydroxyalkylaliphatic groups (i.e. the alkyl part of which is a C_1 - C_4 alkyl), or else R_{13} , R_{14} , R_{15} and R_{16} , together or separately, constitute, with the nitrogen atoms to which they are attached, heterocycles optionally containing a second heteroatom other than nitrogen, or else R_{13} , R_{14} , R_{15} and R_{16} each represent a linear or branched C_1 - C_6 alkyl group substituted with a nitrile, ester, acyl or amide group or a $-\text{CO}-\text{O}-\text{R}_{17}-\text{E}$ or $-\text{CO}-\text{NH}-\text{R}_{17}-\text{E}$ group where R_{17} is an alkylene group and E is a quaternary ammonium group;

A_1 and B_1 represent polymethylene groups containing from 2 to 8 carbon atoms, which may be linear or branched and saturated or unsaturated and may contain, bonded to or inserted into the main chain, one or more aromatic rings, or one or more oxygen or sulphur atoms or sulfoxide, sulphone, disulphide, amino, alkylamino, hydroxyl, quaternary ammonium, ureido, amide or ester groups; and

X- denotes an anion derived from a mineral or organic acid;

A_1 , R_{13} and R_{15} may, with the two nitrogen atoms to which they are attached, form a piperazine ring; moreover, if A_1 denotes a linear or branched, saturated or unsaturated alkylene or hydroxyalkylene group, B_1 may also denote a group:

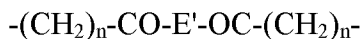

in which n denotes an integer from 0 to 7 and E' denotes:

a) a glycol residue of formula $-\text{O}-\text{Z}-\text{O}-$, in which Z denotes a linear or branched hydrocarbon-based group, or a group corresponding to one of the following formulae:

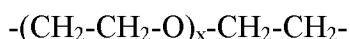

30

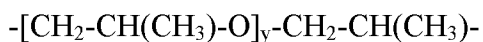

in which x and y each denote an integer from 1 to 4, representing a defined and unique degree of polymerization or any number from 1 to 4 representing an average degree of polymerization,

- 5 b) a bis-secondary diamine residue such as a piperazine derivative;
- c) a bis-primary diamine residue of formula -NH-Y-NH- , where Y denotes a linear or branched hydrocarbon-based group, or else the divalent group $\text{-CH}_2\text{-CH}_2\text{-S-S-CH}_2\text{-CH}_2\text{-}$;
- d) a ureylene group of formula -NH-CO-NH- .

10 Preferably, X⁻ is an anion such as chloride or bromide.

Polymers of this type are described in particular in French patents 2 320 330, 2 270 846, 2 316 271, 2 336 434 and 2 413 907 and US patents 2 273 780, 2 375 853, 2 388 614, 2 454 547, 3 206 462, 2 261 002, 2 271 378, 3 874 870, 4 001 432, 3 929 990, 3 966 904, 4 005 193, 4 025 617, 4 025 627, 4 025 653, 15 4 026 945 and 4 027 020.

Use may more particularly be made of polymers that are formed from repeating units corresponding to formula (XIV):

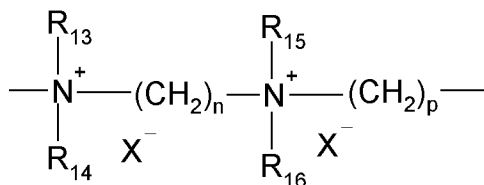

(XIV)

20 in which R₁₃, R₁₄, R₁₅ and R₁₆, which may be identical or different, each denote an alkyl or hydroxyalkyl group having from 1 to 4 carbon atoms approximately, n and p are integers ranging from 2 to 8 approximately, and X⁻ is an anion derived from a mineral or organic acid. Preferably, R₁₃, R₁₄, R₁₅ and R₁₆ each
 25 denote a methyl group. As an example of a polymer that can be used which corresponds to the formula (XIV), mention may be made of hexadimethrine chloride, sold under the name Mexomere PO by the company Chimex.

(9)Polyquaternary ammonium polymers composed of units of formula (XV):

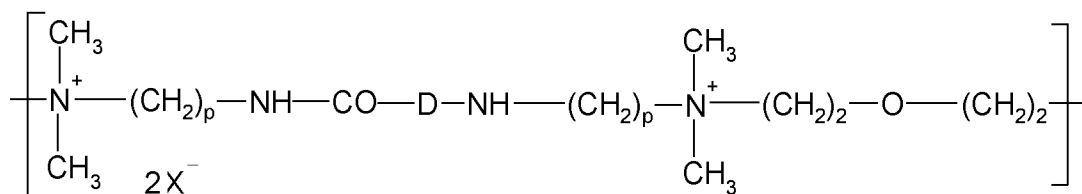

(XV)

in which:

p denotes an integer ranging from 1 to 6 approximately;

5 D may be nothing or may represent a group

—(CH₂)_r—CO— in which r denotes a number equal to 4 or 7, and

X⁻ denotes an anion derived from a mineral or organic acid.

The cationic polymers comprising units of formula (XV) are especially described in patent application EP-A-122 324 and may be prepared according to the processes described in US patents 4 157 388, 4 390 689, 4 702 906 and 4 719 282.

Among these polymers, preference is given to those having a molecular weight measured by carbon-13 NMR of less than 100 000, and in the formula of which:

p is equal to 3, and

15 a) D represents a -(CH₂)₄-CO- group, X denotes a chlorine atom, the molecular weight measured by carbon-13 NMR (¹³C NMR) being around 5600; a polymer of this type is available from the company Miranol under the name Mirapol-AD1,

20 b) D represents a —(CH₂)₇—CO —group, X denotes a chlorine atom, the molecular weight measured by carbon-13 NMR (¹³C NMR) being around 8100; a polymer of this type is available from the company Miranol under the name Mirapol-AZ1,

25 c) D denotes the value zero, X denotes a chlorine atom, the molecular weight measured by carbon-13 NMR (¹³C NMR) being around 25 500; a polymer of this type is sold by the company Miranol under the name Mirapol-A15,

30 d) a "Block Copolymer" formed from units corresponding to the polymers described in paragraphs a) and c), available from the company Miranol under the names Mirapol-9, (¹³C NMR molecular weight around 7800) Mirapol-175, (¹³C NMR molecular weight around 8000) Mirapol-95, (¹³C NMR molecular weight around 12 500).

More particularly still, preference is given, according to the invention, to the polymer having units of formula (XV) in which p is equal to 3, D denotes the value zero, X denotes a chlorine atom, the molecular weight measured by carbon-13 NMR (¹³C NMR) being around 25 500.

5 (10) Quaternary polymers of vinylpyrrolidone and of vinylimidazole, for instance the products sold under the names Luviquat FC 905, FC 550 and FC 370 by the company BASF.

(11) Ethoxylated cationic tallow polyamines such as Polyquart H sold by Henkel, referred to under the name Polyethylene Glycol (15) Tallow Polyamine in
10 the CTFA dictionary.

(12) Vinylamide homopolymers or copolymers and in particular partially hydrolysed vinylamide homopolymers such as poly(vinylamine/vinylamide)s. These polymers are formed from at least one vinylamide monomer corresponding to the following formula:



in which R, R¹ and R² are each chosen from a hydrogen atom, a C₁-C₂₀ alkyl group, an aryl group and an alkylaryl group, the alkyl part of which comprises from 1 to 20 carbon atoms.

20 In particular, said monomer may be chosen from N-vinylformamide, N-methyl-N-vinylacetamide and N-vinylacetamide. Preferably, use is made of the poly(vinylamine/N-vinylformamide) as sold under the name Catiofast VMP by the company BASF or under the name Lupamin 9030 by the company BASF.

25 These polymers may be formed, for example, by radical polymerization of a vinylamide monomer then partial acid or basic hydrolysis of the amide functions to give quaternizable amine functions, as described in patent applications WO 2007/005577, US 5,374,334, US 6,426,383 and US 6,894,110.

(13) Cationic polyurethanes.

30 Among all the polyurethanes mentioned above, use is preferably made of the polyurethanes formed by the following monomers:

(a1) at least one N-methyl diethanolamine (denoted by NMDEA),

(a2) at least one nonionic ethylene/butylene copolymer as sold under the name Krasol LBH-P 2000, and

(b) at least one isophorone diisocyanate (denoted by IPDI).

Preferably, the amines forming the cationic units (a1) represent from 0.1% to 50% by weight, in particular from 1% to 30% by weight, and better still from 5% to 20% by weight, of the total weight of the final polyurethane.

5 These polyurethanes and their syntheses are described for example in patent application FR-A-289 8 603.

(14) Other cationic polymers that can be used in the context of the invention are cationic proteins or cationic protein hydrolysates, polyalkyleneimines, in particular polyethyleneimines, polymers containing vinylpyridine or vinylpyridinium units, and chitin derivatives.

10 Among all cationic polymers that are able to be used in the context of the invention, it is preferred to use a copolymer of hydroxyethyl cellulose and of diallyldimethylammonium chloride (Polyquaternium-4) or of polyquaternium-11 in the composition according to the invention.

15 If present, the composition according to the invention may comprise from 0.001% to 5% by weight, in particular from 0.01% to 2% by weight of cationic polymer(s) relative to the total weight of the composition.

The composition according to the invention may also comprise one or more silicones, preferably amino silicones.

20 The expression "amino silicone" is understood to mean any silicone comprising at least one primary, secondary or tertiary amine function or a quaternary ammonium group.

The amino silicones used in the cosmetic composition according to the present invention are chosen from:

25 (a) the compounds corresponding to formula (XVI) below:

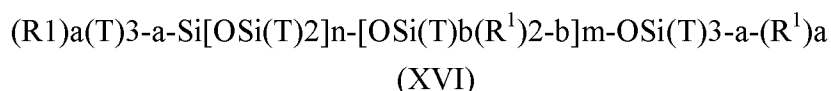

in which:

30 T is a hydrogen atom or a phenyl, hydroxyl (-OH) or C₁-C₈ alkyl radical, and preferably methyl, or a C₁-C₈ alkoxy, preferably methoxy,

a denotes the number 0 or an integer from 1 to 3, and preferably 0,

b denotes 0 or 1, and in particular 1,

m and n are numbers such that the sum (n + m) can range especially from 1 to 2000 and in particular from 50 to 150, it being possible for n to denote a number

from 0 to 1999 and in particular from 49 to 149, and for m to denote a number from 1 to 2000 and in particular from 1 to 10;

R^1 is a monovalent radical of formula $-C_qH_{2q}L$ in which q is a number from 2 to 8 and L is an optionally quaternized amino group chosen from the following groups:

5

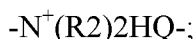
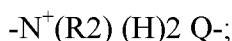
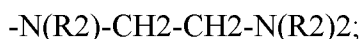

10

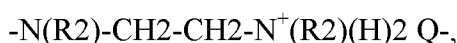

in which R^2 denotes a hydrogen atom, a phenyl, a benzyl or a saturated monovalent hydrocarbon-based radical, for example a C_1 - C_{20} alkyl radical, and Q^- represents a halide ion, for instance fluoride, chloride, bromide or iodide.

In particular, the amino silicones corresponding to the definition of formula (XVII) are chosen from the compounds corresponding to the following formula:

15

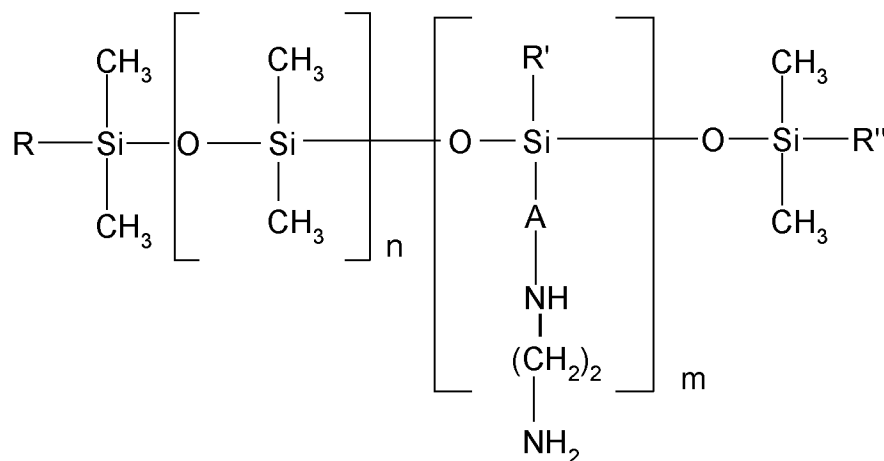

(XVII)

in which R, R' and R'', which may be identical or different, denote a C_1 - C_4 alkyl radical, preferably CH_3 ; a C_1 - C_4 alkoxy radical, preferably methoxy; or OH; A represents a linear or branched, C_3 - C_8 and preferably C_3 - C_6 alkylene radical; m and n are integers that are dependent on the molecular weight and whose sum is between 1 and 2000.

20

According to a first possibility, R, R' and R'', which may be identical or different, represent a C_1 - C_4 alkyl or hydroxyl radical, A represents a C_3 alkylene radical and m and n are such that the weight-average molecular weight of the

compound is between 5000 and 500 000 approximately. Compounds of this type are referred to in the CTFA dictionary as "amodimethicones".

According to a second possibility, R, R' and R", which may be identical or different, represent a C₁-C₄ alkoxy or hydroxyl radical, at least one of the radicals R or R" is an alkoxy radical and A represents a C₃ alkylene radical. The hydroxy/alkoxy molar ratio is preferably between 0.2/1 and 0.4/1 and advantageously equal to 0.3/1. Moreover, m and n are such that the weight-average molecular weight of the compound is between 2000 and 10⁶. More particularly, n is between 0 and 999 and m is between 1 and 1000, the sum of n and m being between 1 and 1000.

In this category of compounds, mention may be made, *inter alia*, of the product Belsil® ADM 652 sold by Wacker.

According to a third possibility, R and R", which are different, represent a C₁-C₄ alkoxy or hydroxyl radical, at least one of the radicals R or R" is an alkoxy radical, R' represents a methyl radical and A represents a C₃ alkylene radical. The hydroxy/alkoxy molar ratio is preferably between 1/0.8 and 1/1.1 and advantageously is equal to 1/0.95. Moreover, m and n are such that the weight-average molecular weight of the compound is between 2000 and 200 000. More particularly, n is between 0 and 999 and m is between 1 and 1000, the sum of n and m being between 1 and 1000.

More particularly, mention may be made of the product Fluid WR® 1300 sold by Wacker.

According to a fourth possibility, R and R" represent a hydroxyl radical, R' represents a methyl radical and A is a C₄-C₈ and preferably C₄ alkylene radical. Moreover, m and n are such that the weight-average molecular weight of the compound is between 2000 and 10⁶. More particularly, n is between 0 and 1999 and m is between 1 and 2000, the sum of n and m being between 1 and 2000.

A product of this type is especially sold under the name DC 28299 by Dow Corning.

Note that the molecular weight of these silicones is determined by gel permeation chromatography (ambient temperature, polystyrene standard; μ styragem columns; eluent THF; flow rate 1 mm/min; 200 μ l of a solution containing 0.5% by weight of silicone in THF are injected, and detection is performed using a refractometer and a UV meter).

A product corresponding to the definition of formula (XVI) is in particular the polymer known in the CTFA dictionary as "trimethylsilylamodimethicone", corresponding to formula (XVIII) below:

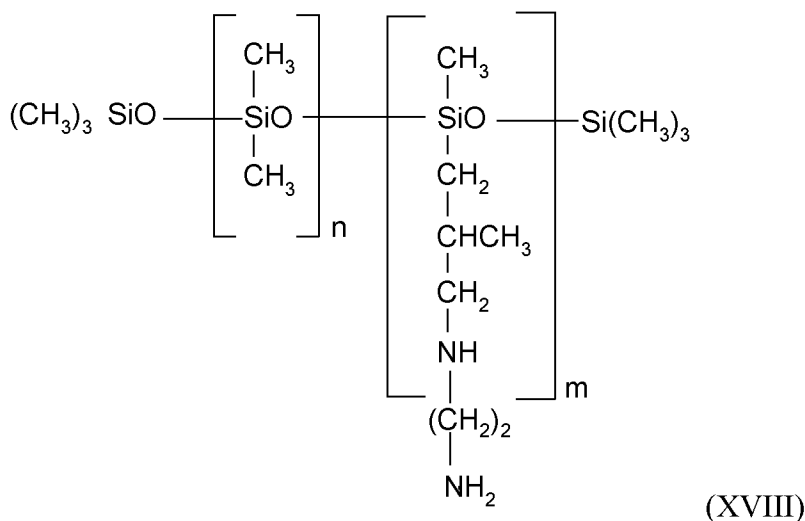

5 in which n and m have the meanings given above in accordance with formula (XVI).

Such compounds are described, for example, in patent EP 95238; a compound of formula (XVIII) is sold, for example, under the name Q2-8220 by the company OSI.

10 (b) the compounds corresponding to formula (XIX) below:

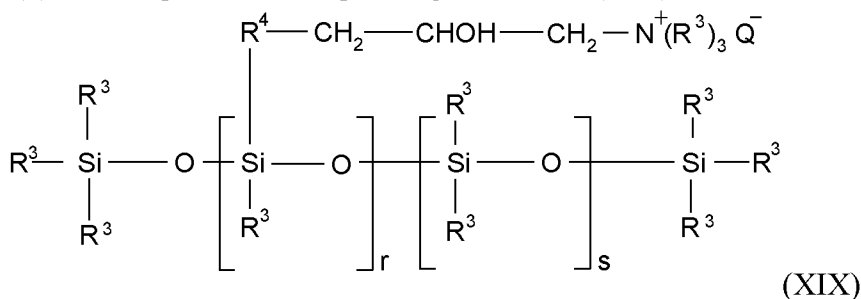

in which:

R³ represents a C₁-C₁₈ monovalent hydrocarbon-based radical, and in particular a C₁-C₁₈ alkyl or C₂-C₁₈ alkenyl radical, for example methyl;

15 R⁴ represents a divalent hydrocarbon-based radical, especially a C₁-C₁₈ alkylene radical or a divalent C₁-C₁₈, and for example C₁-C₈, alkyleneoxy radical;

Q⁻ is a halide ion, in particular chloride;

r represents a mean statistical value from 2 to 20 and in particular from 2 to 8;

s represents a mean statistical value from 20 to 200 and in particular from 20 to 50.

Such compounds are described more particularly in patent US 4 185 087.

A compound falling within this class is the product sold by the company Union Carbide under the name Ucar Silicone ALE 56.

(c) the quaternary ammonium silicones of formula (XX):

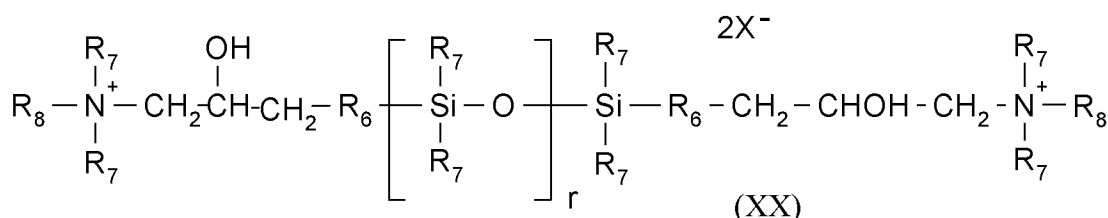

in which:

R_7 , which may be identical or different, represent a monovalent hydrocarbon-based radical containing from 1 to 18 carbon atoms, and in particular a C_1 - C_{18} alkyl radical, a C_2 - C_{18} alkenyl radical or a ring comprising 5 or 6 carbon atoms, for example methyl;

R_6 represents a divalent hydrocarbon-based radical, especially a C_1 - C_{18} alkylene radical or a divalent C_1 - C_{18} , and for example C_1 - C_8 , alkyleneoxy radical linked to the Si via an SiC bond;

R_8 , which may be identical or different, represent a hydrogen atom, a monovalent hydrocarbon-based radical containing from 1 to 18 carbon atoms, and in particular a C_1 - C_{18} alkyl radical, a C_2 - C_{18} alkenyl radical or a radical $-\text{R}_6\text{-NHCOR}_7$;

X^- is an anion such as a halide ion, especially chloride, or an organic acid salt (acetate, etc.);

r represents a mean statistical value from 2 to 200 and in particular from 5 to 100;

These silicones are described, for example, in patent application EP-A-0 530 974.

(d) the amino silicones of formula (XXI):

30

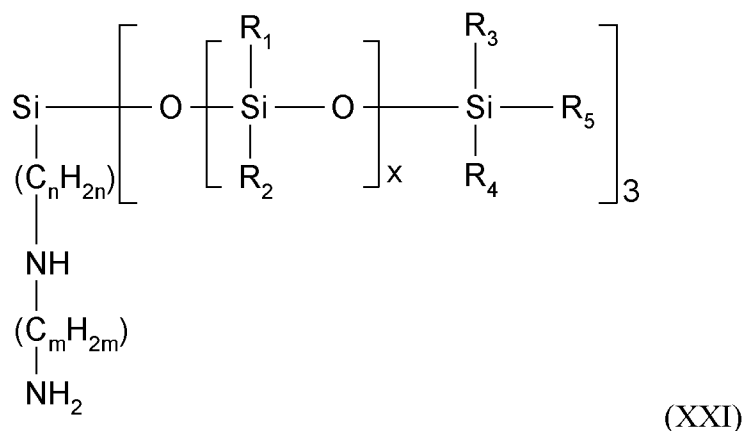

in which:

- R₁, R₂, R₃ and R₄, which may be identical or different, denote a C₁-C₄ alkyl radical or a phenyl group,
 - 5 - R₅ denotes a C₁-C₄ alkyl radical or a hydroxyl group,
 - n is an integer ranging from 1 to 5,
 - m is an integer ranging from 1 to 5,
- and in which x is selected such that the amine number is between 0.01 and 1 meq/g.

10 The silicone that is particularly preferred is amodimethicone.

If present, the composition according to the invention may comprise preferably from 0.01% to 10% by weight of silicone(s), preferably amino silicone(s), and better still from 0.1% to 1.5% by weight of silicone(s) relative to the total weight of the composition.

15 The composition according to the invention may also comprise one or more cosmetic additives commonly used in the art, such as, for example, antioxidants, organic ultraviolet screening agents, inorganic ultraviolet screening agents, softeners, antifoaming agents, moisturizing agents, emollients, plasticizers, mineral fillers, clays, colloidal minerals, pearlescent agents, fragrances, peptizing agents, 20 preservatives, fixing or nonfixing polymers, proteins and vitamins, and mixtures of these compounds.

A person skilled in the art will take care to select the optional additives and the amounts thereof such that they do not harm the properties of the compositions of the present invention.

25 When they are present, these additives may represent an amount ranging from 0.001% to 90% by weight, preferably from 0.001% to 50% by weight and better

still from 0.001% to 20% by weight, relative to the total weight of the composition according to the invention.

The composition according to the invention generally comprises water or a mixture of water and one or more organic solvents.

5 Examples of organic solvents that may be mentioned include lower (C₁-C₄) alcohols, such as ethanol, isopropanol, *tert*-butanol or n-butanol; polyols such as propylene glycol and glycerol; polyol ethers; C₅-C₁₀ alkanes; C₃-C₄ ketones such as acetone; C₁-C₄ alkyl acetates such as methyl acetate, ethyl acetate and butyl acetate; dimethoxyethane, diethoxyethane; and mixtures thereof.

10 When the composition according to the invention comprises one or more organic solvents, these solvents may be present in a proportion of from 0.1% to 30% by weight and preferably from 0.1% to 10% by weight of the total weight of the composition.

The pH of the composition according to the invention, if it is aqueous, generally ranges from 1.5 to 11, preferably from 2 to 6.5 and better still from 2 to 5.

It may be adjusted to the desired value by means of acidifying or alkalinizing agent(s) usually used in the dyeing of keratin fibres, or alternatively using standard buffer system(s).

20 Among the acidifying agents, examples that may be mentioned include mineral or organic acids, for instance hydrochloric acid, orthophosphoric acid, sulphuric acid and sulphonic acids, and carboxylic acids, for instance acetic acid, tartaric acid, citric acid or lactic acid.

25 Among the alkalinizing agents, examples that may be mentioned include aqueous ammonia, alkali metal carbonates, alkanolamines, such as monoethanolamine, diethanolamine and triethanolamine and derivatives thereof, sodium hydroxide, potassium hydroxide and the compounds of formula (XXII) below:

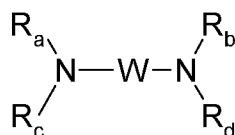

(XXII)

30 in which:

W is a propylene residue optionally substituted with a hydroxyl group or a C₁-C₄ alkyl group;

R_a, R_b, R_c and R_d, which may be identical or different, represent a hydrogen atom or a C₁-C₄ alkyl or C₁-C₄ hydroxyalkyl group.

5 The composition according to the invention may be in any galenic form normally used for topical application. In particular, the composition according to the invention may be a lotion, a gel, a spray, a foam, or a cream.

The composition according to the invention may be a shampoo, a conditioner, a hair-shaping product, a colouring product, a bleaching product, a permanent-wave product.

Preferably, the composition according to the invention is a conditioner.

10 It may be used as an antimicrobial and antifungal agent of a cosmetic composition or be used directly to treat keratin materials against the proliferation of microbes, yeasts, fungi, and moulds in a cosmetic composition, and the undesirable cosmetic effects associated with such a proliferation, such as the appearance or development of dandruff, redness, acne, comedones, cysts or blackheads. It may especially be used as a disinfectant, antidandruff active agent or cleansing agent for the skin.

The composition according to the invention may be a rinse-out or leave-in composition.

20 The expression "keratin materials" is understood to mean the skin, the scalp and the integuments such as the hair.

Preferably the keratin materials treated within the context of the invention are the scalp and the hair.

25 Another subject of the invention is a cosmetic treatment method that comprises the application to the skin or hair and scalp of a composition according to the invention as described above, especially for a long enough time to eliminate or reduce the presence of microbes. For example, the composition may be left on the skin or the hair and the scalp for 2 to 15 minutes. This application may or may not be followed by a rinsing operation.

30 The examples which follow are intended to illustrate the invention without however, exhibiting a limiting nature.

EXAMPLESLeave-in compositions according to the invention

5 The amounts are indicated as weight percentages of active material (AM) relative to the total weight of each composition.

The weight ratio of the amount of zinc salt to the amount of 1,2-octanediol (denoted by R) and the weight ratio of the amount of zinc element to the amount of 1,2-octanediol (denoted by R') were calculated for each composition.

Composition	A
Zinc gluconate	0.5
1,2-octanediol	0.4
Sodium benzoate	0.5
Water	qs 100
	pH = 4
R	1.25
R'	0.18

10

Composition	B
Zinc gluconate	1.5
1,2-octanediol	0.4
Water	qs 100
	pH = 4
R	3.75
R'	0.55

Composition	C
Zinc chloride	1
1,2-octanediol	0.4
Citric acid	qs pH = 4
Water	qs 100
R	2.5
R'	1.2

Composition	D
Zinc sulphate heptahydrate	1.5
1,2-octanediol	0.4
Sodium benzoate	0.5
Citric acid	qs pH = 4
Water	qs 100
R	3.75
R'	0.85

Composition	E
Zinc gluconate	0.5
1,2-octanediol	0.2
Benzoic acid	0.2
Water	qs 100
	pH = 4
R	2.5
R'	0.36

Composition	F
Zinc gluconate	0.5
1,2-octanediol	0.4
Water	qs 100
	pH = 4
R	1.25
R'	0.18

5

with:

-the zinc gluconate sold under the name Givobio G Zn (100% by weight of AM) by the company SEPPIC,

-the 1,2-octanediol sold under the name Dermosoft octiol by the company Dr Straetmans,

- the sodium benzoate sold under the name Purox S by the company DSM,
 -the zinc chloride sold under the name Zinc Chloride (100% AM) by the company Honeywell,
 -the zinc sulphate heptahydrate sold under the name Zinc sulfate heptahydrate (100% by weight of AM) by the company Merck,
 -the benzoic acid sold under the name Purox B by the company DSM.

All these compositions have a satisfactory bacteriological protection. Moreover, it was observed that compositions F and A according to the invention exhibit satisfactory antifungal protection.

Comparative

The following compositions were prepared. The amounts are indicated as weight percentages of active material (AM) relative to the total weight of each composition.

Compositions	F inventive	G comparative	H comparative
Zinc gluconate	0.5	0.5	0.5
1,2-octanediol	0.4	-	-
Sodium benzoate	-	-	-
Polyaminopropyl biguanide	-	0.6	-
Ethanol	-	-	5
Water	qs 100	qs 100	qs 100

The microbiological study of each of these compositions was carried out in two steps:

- the formulae were artificially contaminated with microorganisms (bacteria, yeasts, moulds),
- the decontamination rate of the formulae was monitored by virtue of a monitoring of the number of viable germs over time.

Comparison of compositions F and G:

- Polyaminopropyl biguanide is a homopolymer having a molecular weight (MW) equal to 2100 g/mol. The biguanide unit, which exhibits a bactericidal activity, has a molecular weight of 219.5 g/mol, which represents 2.7×10^{-3} mol in formula G.

5 - 1,2-Octanediol has an MW of 146 g/mol; it is therefore introduced at 2.7×10^{-3} mol into composition F.

- At an equal molar amount, composition G containing the polyaminopropyl biguanide has an antifungal protection that is inferior to that of composition F according to the invention containing 1,2-octanediol.

10

Comparison of compositions F and H:

- Compositions F and H contain the same amount of zinc salt. Composition F contains 0.4 g of 1,2-octanediol, whereas composition H contains 5 g of ethanol, a compound renowned for its antibacterial properties. The ethanol, introduced in an amount 10 times greater than that of the 1,2-octanediol, does not make it possible to provide satisfactory antifungal protection.

15

CLAIMS

- 5 1. Cosmetic composition comprising:
 - one or more zinc salts and
 - 1,2-octanediol,
 the weight ratio of the amount of zinc salt to the amount of 1,2-octanediol being
 strictly greater than 1, and
10 the content of 1,2-octanediol being strictly less than 0.5% by weight, relative to the
 total weight of the composition.
2. Composition according to Claim 1, characterized in that the weight ratio
 of the amount of zinc salt to the amount of 1,2-octanediol varies from 1.1 to 100, in
 particular from 1.1 to 50 and more preferably still from 1.1 to 10.
- 15 3. Composition according to Claim 1 or 2, characterized in that the
 concentration of 1,2-octanediol ranges from 0.001% to 0.49% by weight, in particular
 from 0.01% to 0.45% by weight, and better still from 0.1% to 0.45% by weight
 relative to the total weight of the composition.
4. Composition according to any one of the preceding claims, characterized
20 in that the zinc salt(s) is (are) chosen from inorganic and organic water-soluble zinc
 salts, and mixtures thereof.
5. Composition according to any one of the preceding claims, characterized
 in the zinc salt(s) is (are) chosen from inorganic salts and in particular from zinc
 sulphate and zinc chloride.
- 25 6. Composition according to any one of Claims 1 to 4, characterized in the
 zinc salt(s) is (are) chosen from organic salts and in particular from zinc lactate, zinc
 gluconate, zinc phenolsulphonate, zinc citrate, zinc salicylate and derivatives thereof
 corresponding to the following formula, and mixtures thereof

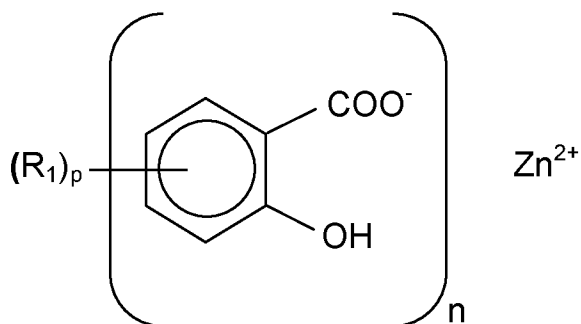

in which formula:

$n = 2$, p is equal to 0, 1, 2 or 3;

R_1 denotes a linear or branched C_1 - C_{18} alkyl group (for example methyl, ethyl, n-propyl, isopropyl, n-butyl); a linear or branched C_1 - C_{18} hydroxyalkyl group; a C_2 - C_{18} acyl group (for example acetyl); a COR_2 or $OCOR_2$ group, where R_2 denotes a hydrogen atom or a linear or branched C_1 - C_{18} alkyl group.

7. Composition according to any one of Claims 1 to 4 and 6, characterized in that the zinc salt is zinc lactate or zinc gluconate.

8. Composition according to Claim 7, characterized in that the zinc salt is zinc gluconate.

9. Composition according to any one of the preceding claims, characterized in that the concentration of zinc salt(s) ranges from 0.1% to 10% by weight, preferably from 0.1% to 6.5% by weight, and better still from 0.2 to 3% by weight, relative to the total weight of the composition.

10. Composition according to any one of the preceding claims, characterized in that it comprises one or more preserving agents chosen from sodium benzoate, benzoic acid, phenoxyethanol, and mixtures thereof, preferably at a concentration varying from 0.01% to 2% by weight, in particular from 0.05% to 0.8% by weight, and better still from 0.1% to 0.8% by weight relative to the total weight of the composition.

11. Composition according to any one of the preceding claims, characterized in that it comprises one or more anionic, zwitterionic or amphoteric, nonionic, or cationic surfactants, or mixtures thereof.

12. Composition according to any one of the preceding claims, characterized in that it comprises one or more fatty alcohols and/or one or more fatty

alcohol and/or fatty acid esters, and/or one or more non-silicone cationic polymers, and/or one or more silicones, preferably amino silicones.

5 13. Method for the cosmetic treatment of keratin materials, characterized in that a composition as defined according to any one of Claims 1 to 12 is applied to keratin materials, with or without subsequent rinsing.

14. Use of a composition as defined in any one of Claims 1 to 12, as an antimicrobial and antifungal agent.

INTERNATIONAL SEARCH REPORT

International application No
PCT/EP2011/073293

A. CLASSIFICATION OF SUBJECT MATTER
INV. A61K8/27 A61K8/34 A61Q17/00
ADD.
According to International Patent Classification (IPC) or to both national classification and IPC

B. FIELDS SEARCHED
Minimum documentation searched (classification system followed by classification symbols)
A61K A61Q
Documentation searched other than minimum documentation to the extent that such documents are included in the fields searched

Electronic data base consulted during the international search (name of data base and, where practical, search terms used)
EPO-Internal, WPI Data

C. DOCUMENTS CONSIDERED TO BE RELEVANT		
Category*	Citation of document, with indication, where appropriate, of the relevant passages	Relevant to claim No.
X	WO 2008/154395 A1 (UNIV COLUMBIA [US]; MODAK SHANTA M [US]; GERALDO INGRID [US]; CARAOS L) 18 December 2008 (2008-12-18) page 14 page 22 - page 26 page 34 page 44	1,13,14
X	US 2009/035390 A1 (MODAK SHANTA M [US] ET AL) 5 February 2009 (2009-02-05) tables 1-4	1
X	EP 1 884 228 A1 (SARA LEE DE NV [NL]) 6 February 2008 (2008-02-06) paragraph [0047]	1,13
	----- -/--	

Further documents are listed in the continuation of Box C.

See patent family annex.

* Special categories of cited documents :

"A" document defining the general state of the art which is not considered to be of particular relevance

"E" earlier document but published on or after the international filing date

"L" document which may throw doubts on priority claim(s) or which is cited to establish the publication date of another citation or other special reason (as specified)

"O" document referring to an oral disclosure, use, exhibition or other means

"P" document published prior to the international filing date but later than the priority date claimed

"T" later document published after the international filing date or priority date and not in conflict with the application but cited to understand the principle or theory underlying the invention

"X" document of particular relevance; the claimed invention cannot be considered novel or cannot be considered to involve an inventive step when the document is taken alone

"Y" document of particular relevance; the claimed invention cannot be considered to involve an inventive step when the document is combined with one or more other such documents, such combination being obvious to a person skilled in the art.

"&" document member of the same patent family

Date of the actual completion of the international search 30 January 2012	Date of mailing of the international search report 06/02/2012
Name and mailing address of the ISA/ European Patent Office, P.B. 5818 Patentlaan 2 NL - 2280 HV Rijswijk Tel. (+31-70) 340-2040, Fax: (+31-70) 340-3016	Authorized officer Yon, Jean-Michel

INTERNATIONAL SEARCH REPORT

International application No
PCT/EP2011/073293

C(Continuation). DOCUMENTS CONSIDERED TO BE RELEVANT		
Category*	Citation of document, with indication, where appropriate, of the relevant passages	Relevant to claim No.
X	FR 2 771 632 A1 (SEPPIC SA [FR]) 4 June 1999 (1999-06-04) page 13	1,13
X	----- EP 1 593 371 A1 (SARA LEE DE NV [NL]) 9 November 2005 (2005-11-09) table 1 -----	1,13,14

INTERNATIONAL SEARCH REPORT

Information on patent family members

International application No PCT/EP2011/073293

Patent document cited in search report	Publication date	Patent family member(s)	Publication date
WO 2008154395	A1	18-12-2008	CA 2690860 A1 18-12-2008
			EP 2152071 A1 17-02-2010
			JP 2010529262 A 26-08-2010
			US 2010216889 A1 26-08-2010
			WO 2008154395 A1 18-12-2008

US 2009035390	A1	05-02-2009	US 2009035390 A1 05-02-2009
			US 2010249227 A1 30-09-2010

EP 1884228	A1	06-02-2008	AT 483499 T 15-10-2010
			DK 2051687 T3 31-01-2011
			EP 1884228 A1 06-02-2008
			EP 2051687 A1 29-04-2009
			ES 2351862 T3 11-02-2011
			PT 2051687 E 23-12-2010
			WO 2008016298 A1 07-02-2008

FR 2771632	A1	04-06-1999	NONE

EP 1593371	A1	09-11-2005	AT 521329 T 15-09-2011
			EP 1593371 A1 09-11-2005
			ES 2372489 T3 20-01-2012
