



US00D645454S

(12) **United States Design Patent**
Quek

(10) **Patent No.:** **US D645,454 S**

(45) **Date of Patent:** **** Sep. 20, 2011**

(54) **HEADPHONES**

(75) Inventor: **Bernard Peng Koon Quek**, Singapore (SG)

(73) Assignee: **Sennheiser electronic GmbH & Co. KG**, Wedemark (DE)

(**) Term: **14 Years**

(21) Appl. No.: **29/364,230**

(22) Filed: **Jun. 21, 2010**

(30) **Foreign Application Priority Data**

Dec. 23, 2009 (EM) 1186191

(51) **LOC (9) Cl.** **14-01**

(52) **U.S. Cl.** **D14/223**

(58) **Field of Classification Search** D14/205,
D14/206, 223; 181/129, 130, 131; 379/430,
379/431; 381/380, 381, 385; 455/90.3, 575.1,
455/569.1

See application file for complete search history.

(56) **References Cited**

U.S. PATENT DOCUMENTS

2,474,135	A *	6/1949	White	381/381
4,273,969	A *	6/1981	Foley et al.	379/430
D272,904	S *	3/1984	Kawano	D14/205
5,210,792	A *	5/1993	Kajihara	379/430
5,412,736	A *	5/1995	Keliiliki	381/381
D375,959	S *	11/1996	Davis et al.	D14/223
5,655,026	A *	8/1997	Peters et al.	381/385
D385,272	S *	10/1997	Jensen et al.	D14/142

6,101,260	A *	8/2000	Jensen et al.	381/381
D460,749	S *	7/2002	Liu	D14/206
6,427,018	B1 *	7/2002	Keliiliki	381/381
6,771,790	B2 *	8/2004	Liu	381/385
D512,984	S *	12/2005	Ham	D14/205
7,089,042	B2 *	8/2006	Bodley	455/569.1
D538,792	S *	3/2007	Kim et al.	D14/223
D542,267	S *	5/2007	Cha et al.	D14/206
D556,735	S *	12/2007	Yeo	D14/206
D557,255	S *	12/2007	Shintani	D14/206
D575,772	S *	8/2008	Schultz et al.	D14/223
D606,048	S *	12/2009	Soetejo et al.	D14/223
7,708,110	B2 *	5/2010	Leong et al.	181/135
D624,529	S *	9/2010	Huang	D14/223
D635,960	S *	4/2011	Gondo et al.	D14/223

* cited by examiner

Primary Examiner — Paula Greene

(74) *Attorney, Agent, or Firm* — Kilpatrick Townsend Stockton LLP

(57) **CLAIM**

The ornamental design for headphones, as shown and described.

DESCRIPTION

FIG. 1 is a perspective view of a headphones showing my new design;

FIG. 2 is a top plan view thereof;

FIG. 3 is a front elevational view thereof;

FIG. 4 is a right side elevational view thereof;

FIG. 5 is a rear elevational view thereof;

FIG. 6 is a bottom plan view thereof; and,

FIG. 7 is a left side elevational view thereof.

1 Claim, 7 Drawing Sheets

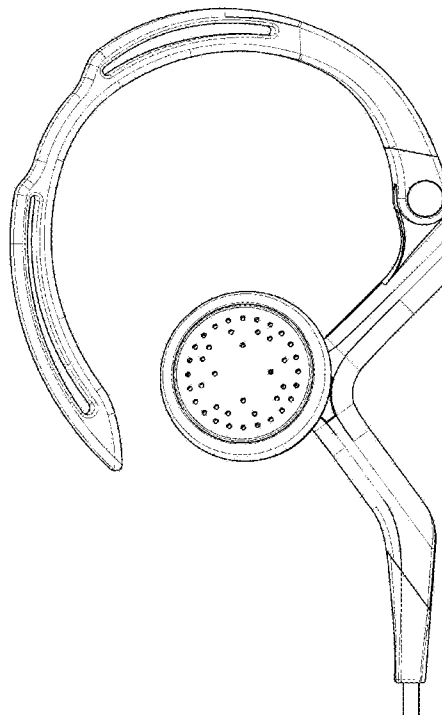
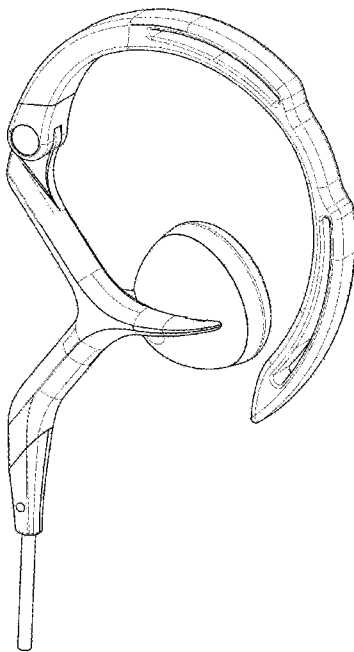

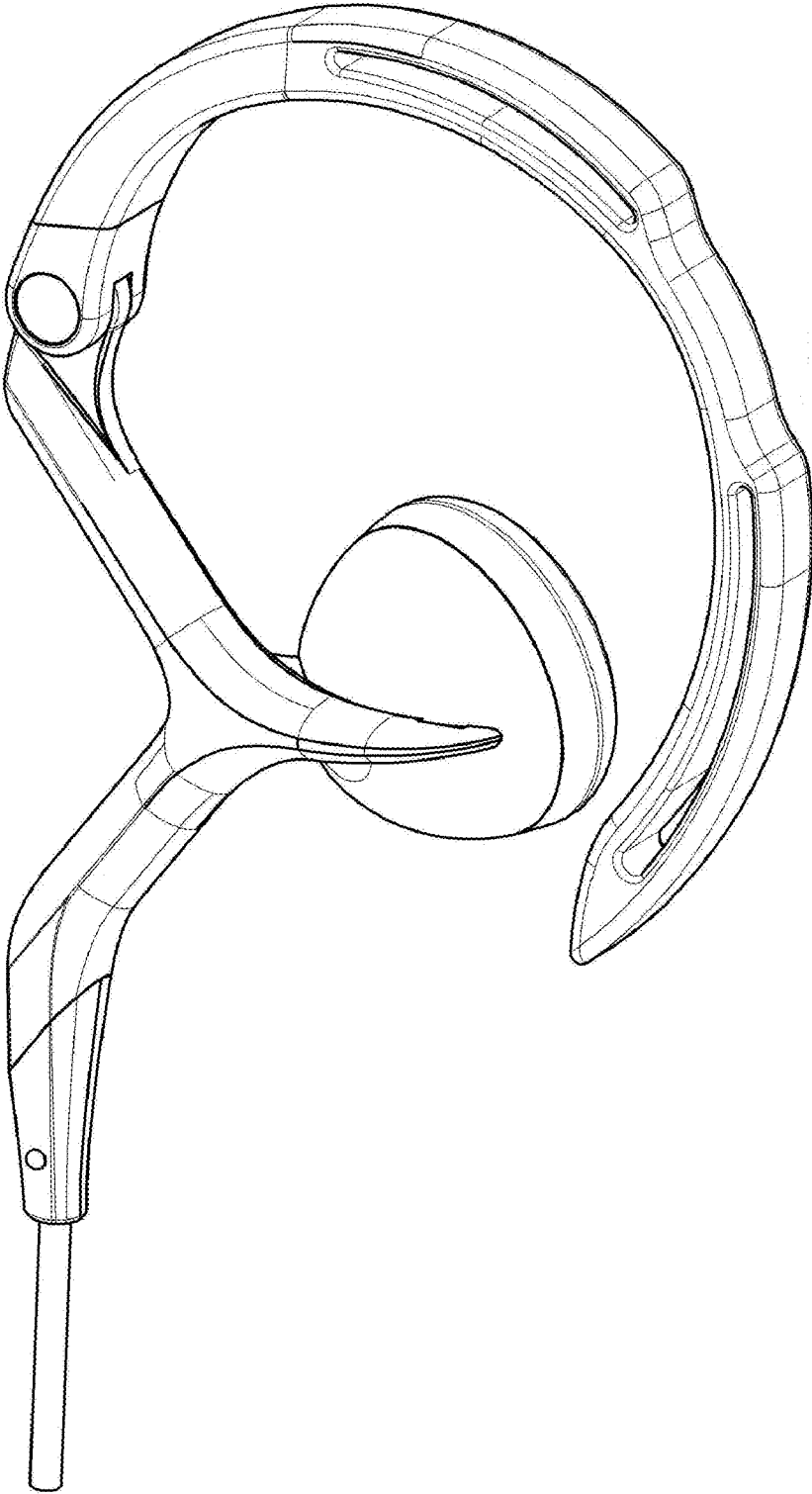

FIG. 1

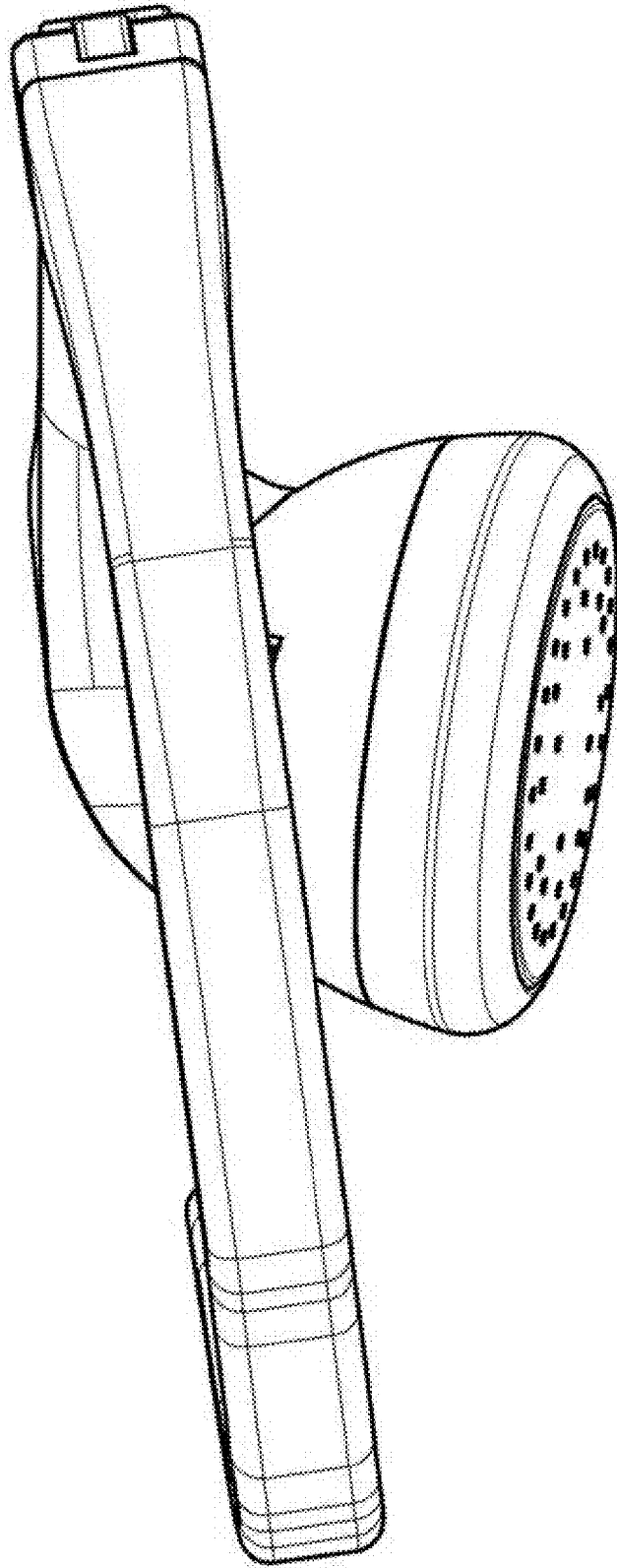

FIG. 2

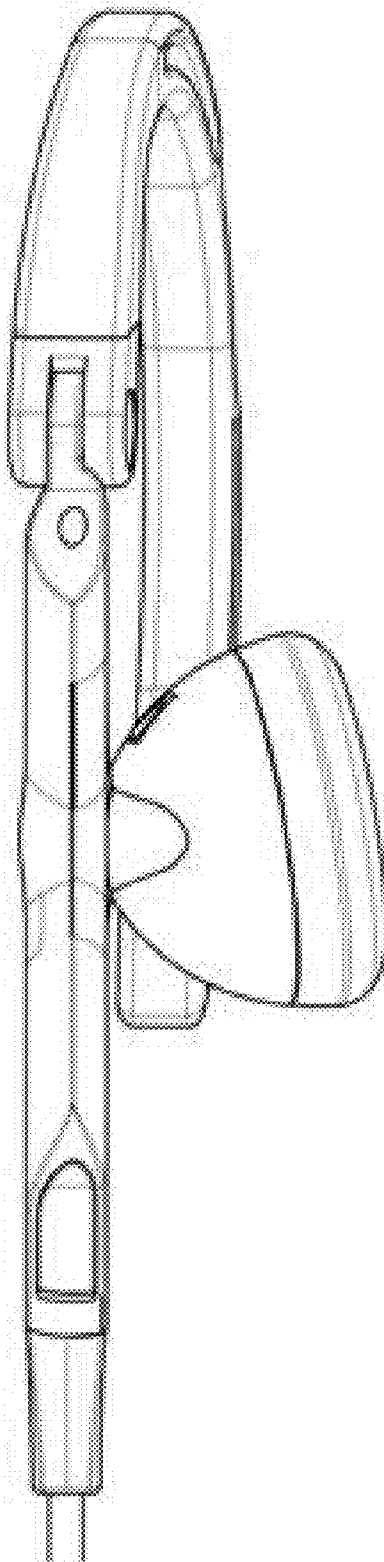

FIG. 3

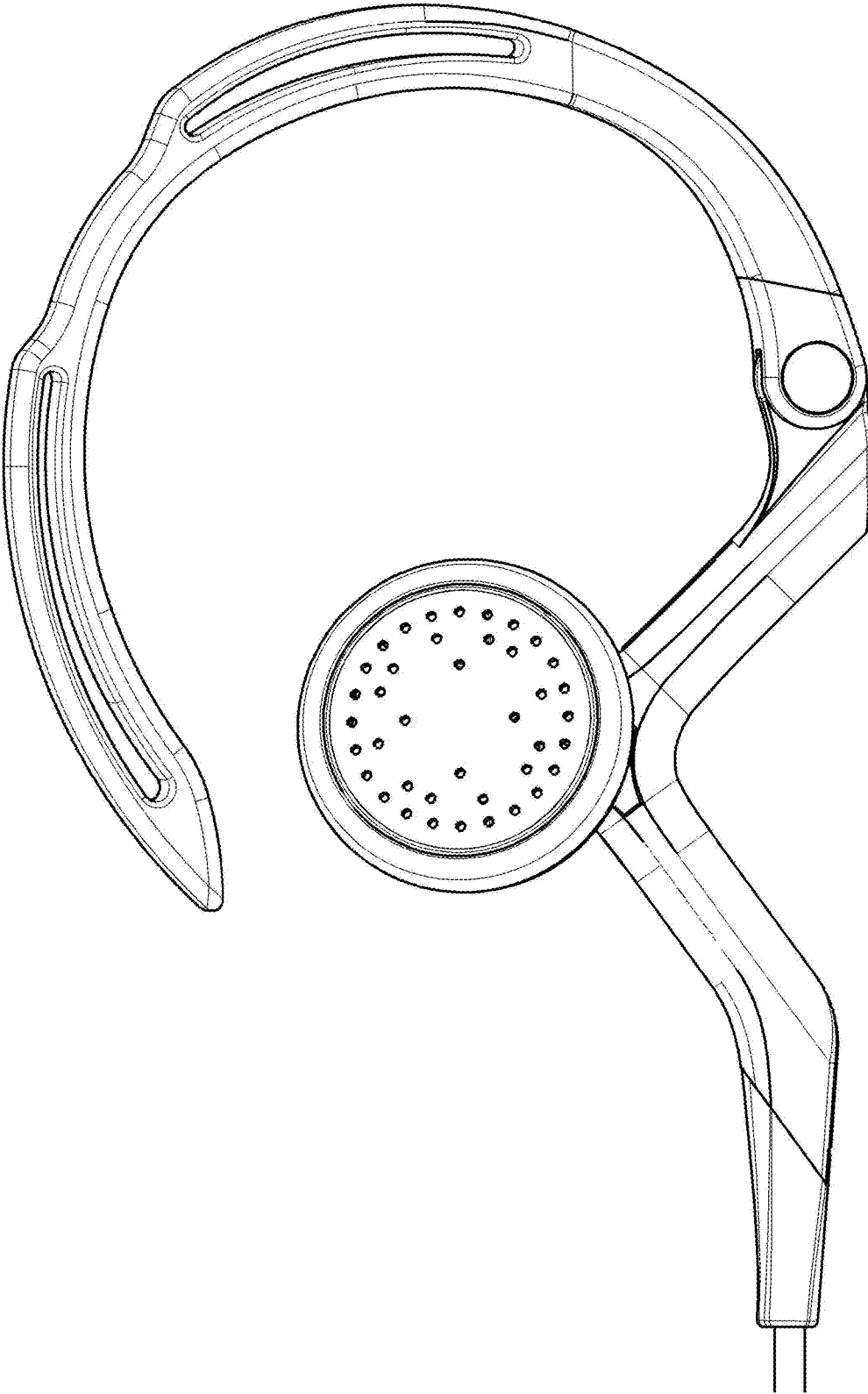

FIG. 4

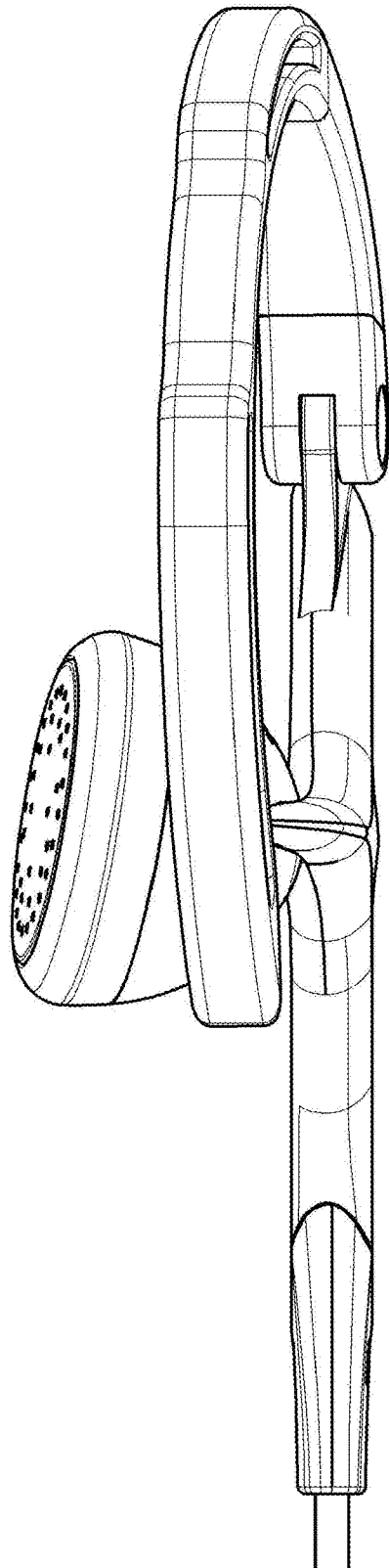

FIG. 5

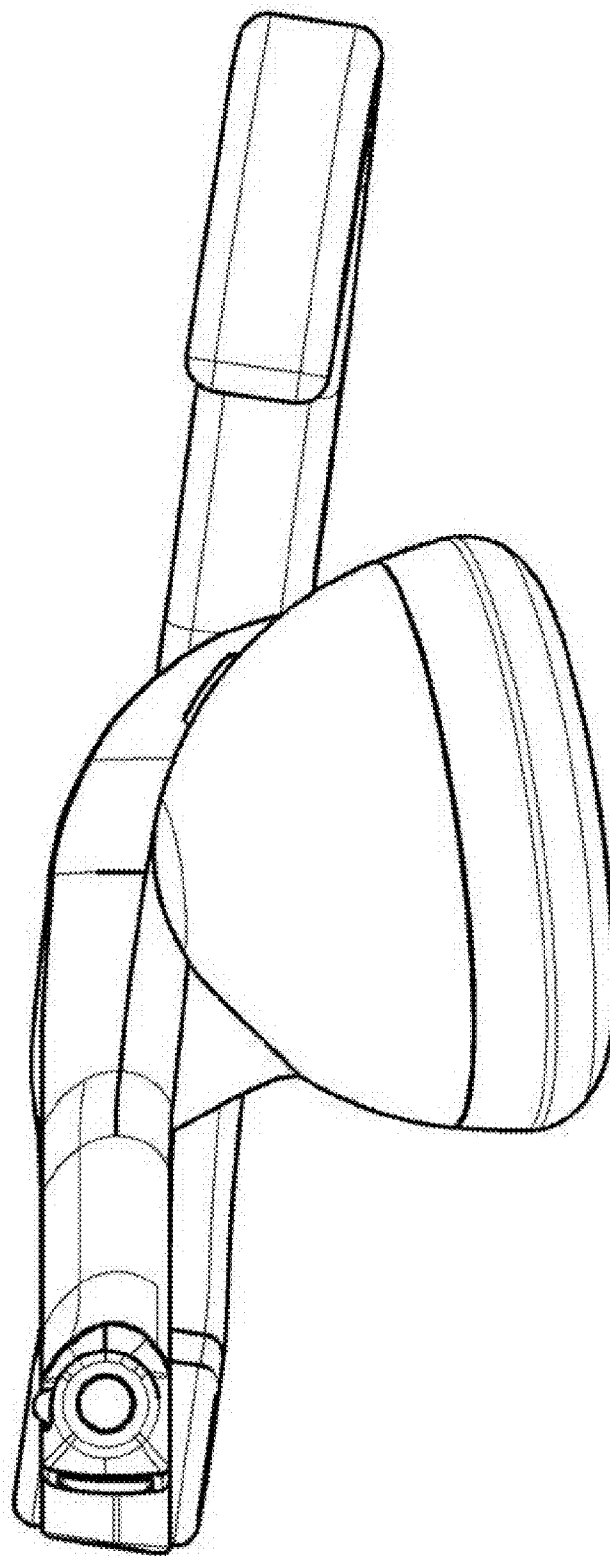

FIG. 6

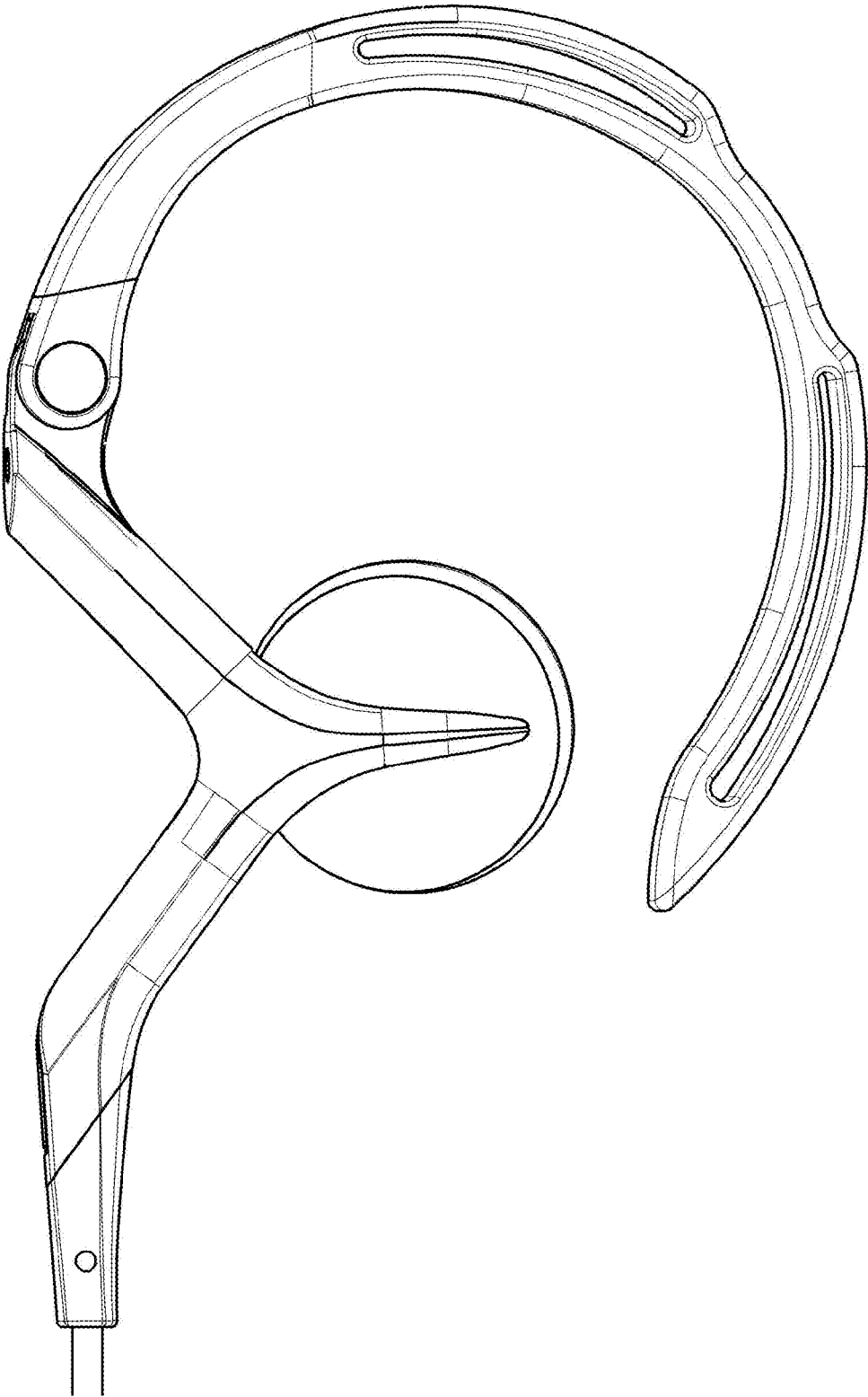

FIG. 7