



(12) **United States Design Patent**
Perez et al.

(10) **Patent No.:** **US D896,451 S**
(45) **Date of Patent:** **** Sep. 15, 2020**

- (54) **TELESCOPING SCOOP**
- (71) Applicant: **Walmart Apollo, LLC**, Bentonville, AR (US)
- (72) Inventors: **Jamie Russell Perez**, Bentonville, AR (US); **Raul Gutierrez**, Rogers, AR (US)
- (73) Assignee: **Walmart Apollo, LLC**, Bentonville, AR (US)
- (**) Term: **15 Years**
- (21) Appl. No.: **29/685,659**
- (22) Filed: **Mar. 29, 2019**
- (51) **LOC (12) Cl.** **30-99**
- (52) **U.S. Cl.**
USPC **D30/162**
- (58) **Field of Classification Search**
USPC D30/161, 162, 199; 119/166, 167, 168, 119/169, 170, 867; 209/419
See application file for complete search history.

(56) **References Cited**

U.S. PATENT DOCUMENTS

5,921,596	A	7/1999	Sheriff et al.	
D480,519	S *	10/2003	Firth	D30/162
7,942,460	B2	5/2011	Boskett et al.	
D679,876	S *	4/2013	Teren	D30/162
D686,787	S *	7/2013	Dabrushman	D30/162
8,955,893	B1	2/2015	Stern et al.	
D799,760	S *	10/2017	Peng	D30/162
D805,264	S *	12/2017	Wendling	D30/162
D833,090	S *	11/2018	Leick	D30/162

(Continued)

OTHER PUBLICATIONS

“Vibrant Life Expandable Aluminum Cat Litter Scoop” available Feb. 23, 2020, [online], [site visited Mar. 25, 2020]. Retrieved from

Internet, URL: <https://www.walmart.com/ip/Vibrant-Life-Expandable-Aluminum-Cat-Litter-Scoop/646939508> (Year: 2020).*

(Continued)

Primary Examiner — Michael C Stout
Assistant Examiner — Katrina N Gonzalez
(74) *Attorney, Agent, or Firm* — McCarter & English, LLP

(57) **CLAIM**

The ornamental design for a telescoping scoop, as shown and described.

DESCRIPTION

FIG. 1 is a front perspective view of a telescoping scoop in an extended configuration with portions removed for clarity of illustration;
 FIG. 2 is a rear perspective view thereof;
 FIG. 3 is a front view thereof;
 FIG. 4 is a rear view thereof;
 FIG. 5 is a left side elevation view thereof;
 FIG. 6 is a right side elevation view thereof;
 FIG. 7 is a top plan view thereof;
 FIG. 8 is a bottom plan view thereof;
 FIG. 9 is another front perspective view thereof, but shown with all portions for clarity of illustration;
 FIG. 10 is another rear perspective view thereof;
 FIG. 11 is another front perspective view thereof, but shown in a collapsed configuration for clarity of illustration;
 FIG. 12 is another rear perspective view thereof;
 FIG. 13 is a front view thereof;
 FIG. 14 is a rear view thereof;
 FIG. 15 is a left side elevation view thereof;
 FIG. 16 is a right side elevation view thereof;
 FIG. 17 is a top plan view thereof; and,
 FIG. 18 is a bottom plan view thereof.

1 Claim, 15 Drawing Sheets

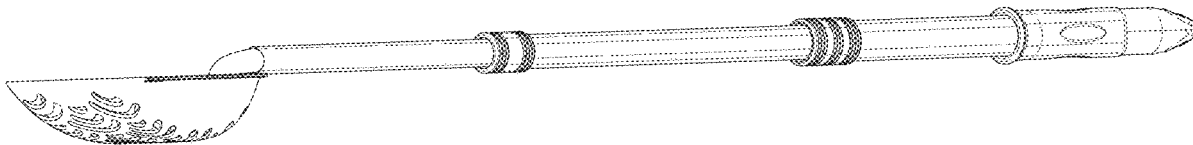

(56)

References Cited

U.S. PATENT DOCUMENTS

2013/0292957 A1* 11/2013 Paculdo A01K 1/0114
294/179
2019/0289811 A1* 9/2019 Veness A01K 1/0114

OTHER PUBLICATIONS

“Whisker City Adjustable Cat Litter Scoop” available 2018, [online], [site visited Mar. 25, 2020]. Retrieved from Internet, URL: <https://www.petsmart.com/cat/litter-and-waste-disposal/waste-disposal/whisker-city-adjustable-cat-litter-scoop-47041.html> (Year: 2018).*
Cats Rule Stand Up & Scoop Extendable Litter Scoop, <https://www.chewy.com/cats-rule-stand-up-scoop-extendable/dp/137148>.
Whisker City Adjustable Cat Litter Scoop, <https://www.petsmart.com/cat/litter-and-waste-disposal/waste-disposal/whisker-city-adjustable-cat-litter-scoop-47041.html?cgid=200155>.
TOYPOPOR Cat Litter Scooper with Deep Shovel-Non Stick Plated Aluminum Telescoping Litter Scoop with Long Handle, <https://www.amazon.com/TOYPOPOR-Stainless-Telescoping-Perfect-Scooper/dp/B07DSVQ4HJ>.
Pet Champion Extendable Aluminum Cat Litter Scoop, <https://www.walmart.com/ip/Pet-Champion-Extendable-Aluminum-Cat-Litter-Scoop/640287675>.

* cited by examiner

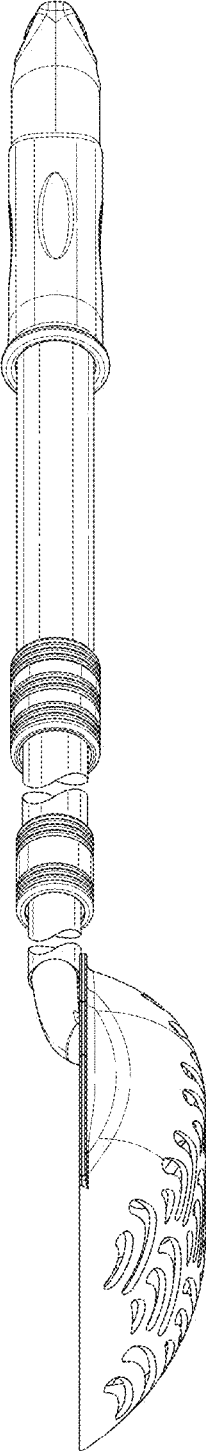

FIG. 1

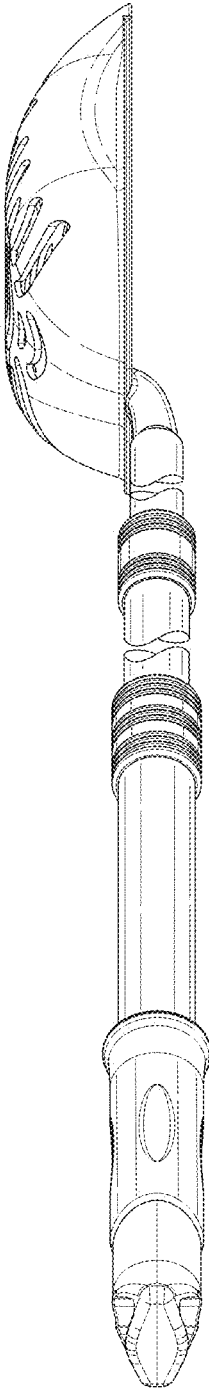

FIG. 2

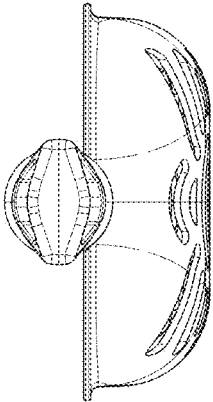

FIG. 4

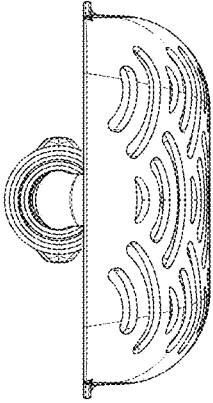

FIG. 3

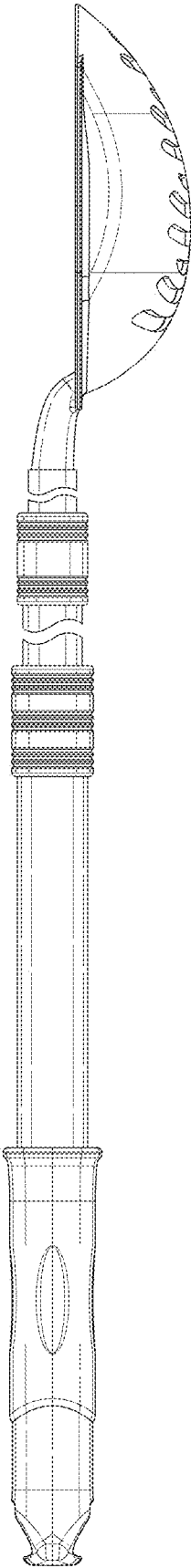

FIG. 5

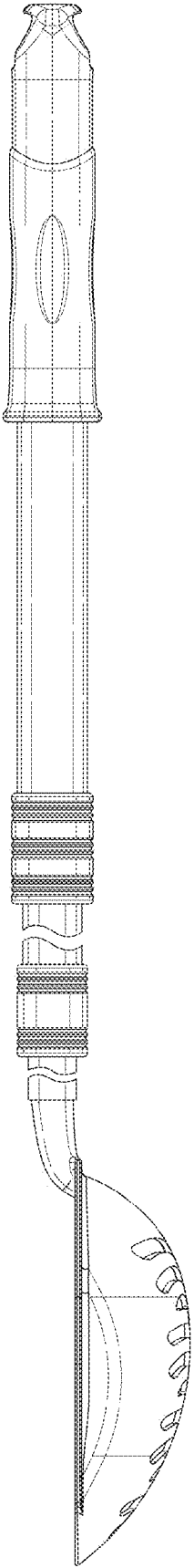

FIG. 6

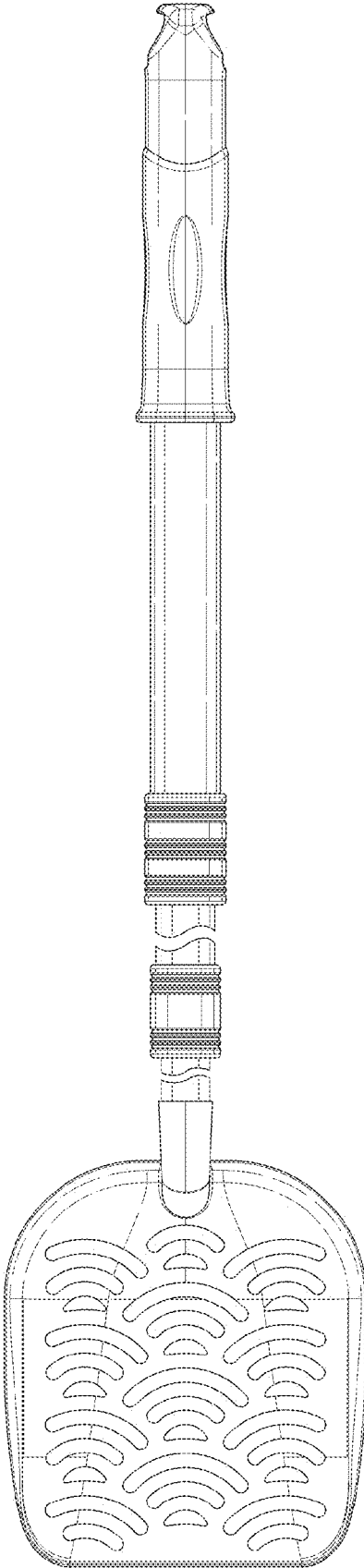

FIG. 7

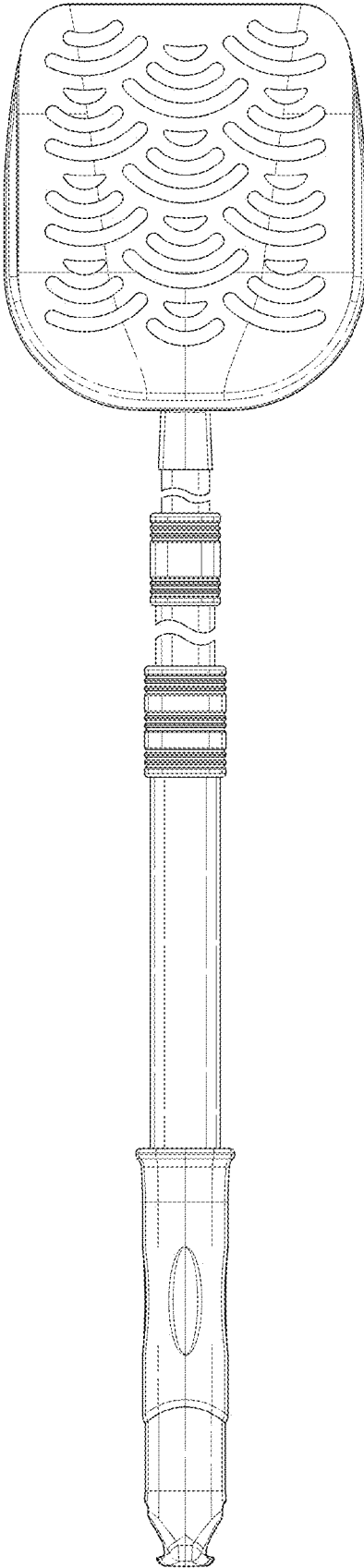

FIG. 8

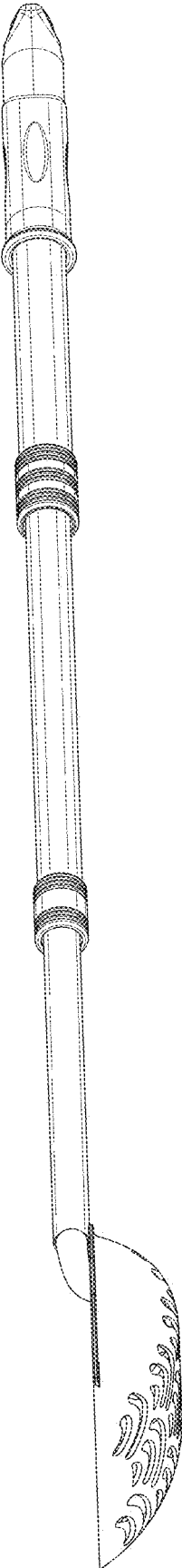

FIG. 9

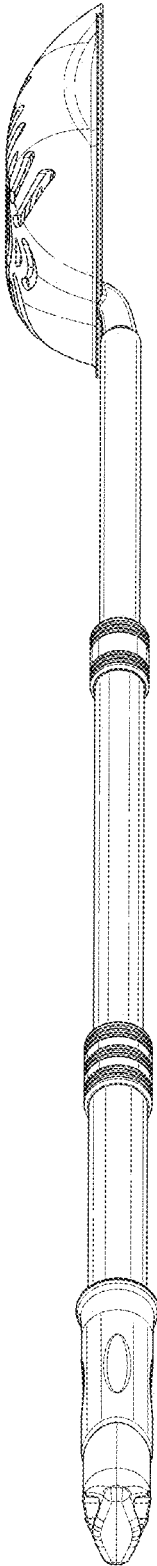

FIG. 10

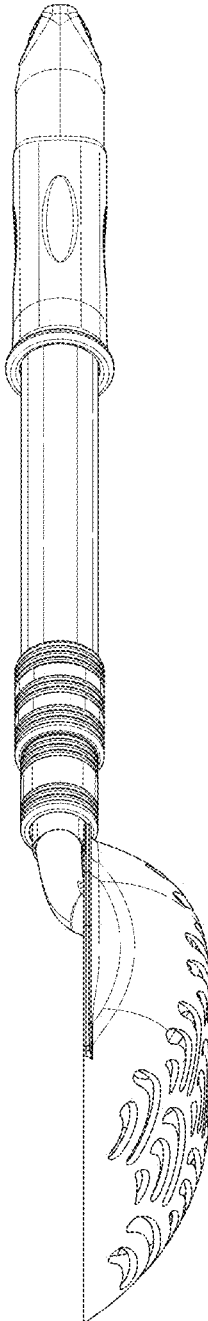

FIG. 11

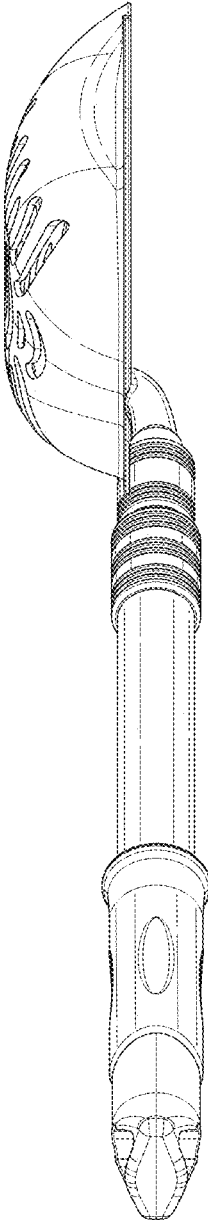

FIG. 12

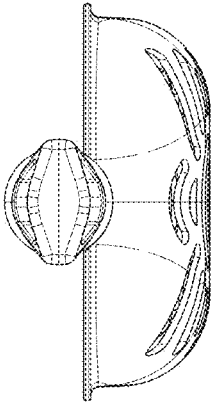

FIG. 13

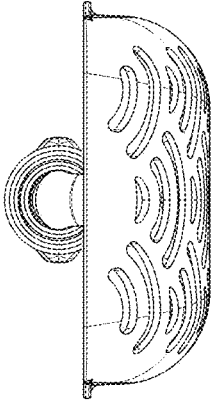

FIG. 14

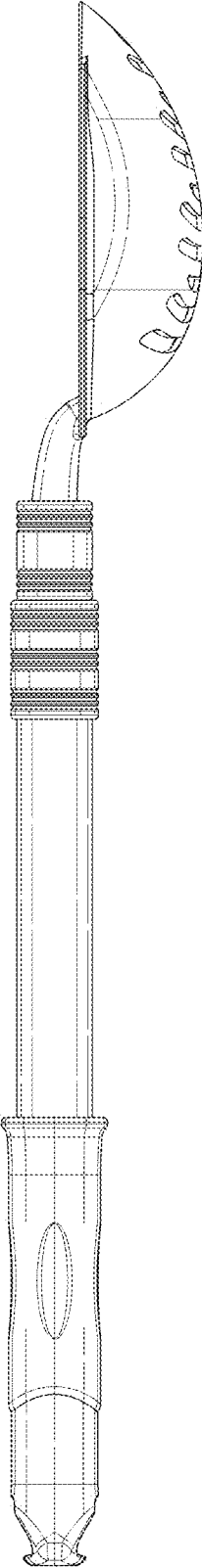

FIG. 15

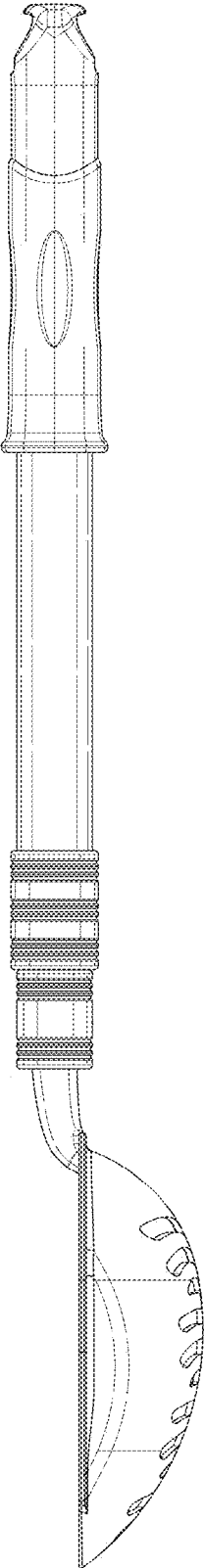

FIG. 16

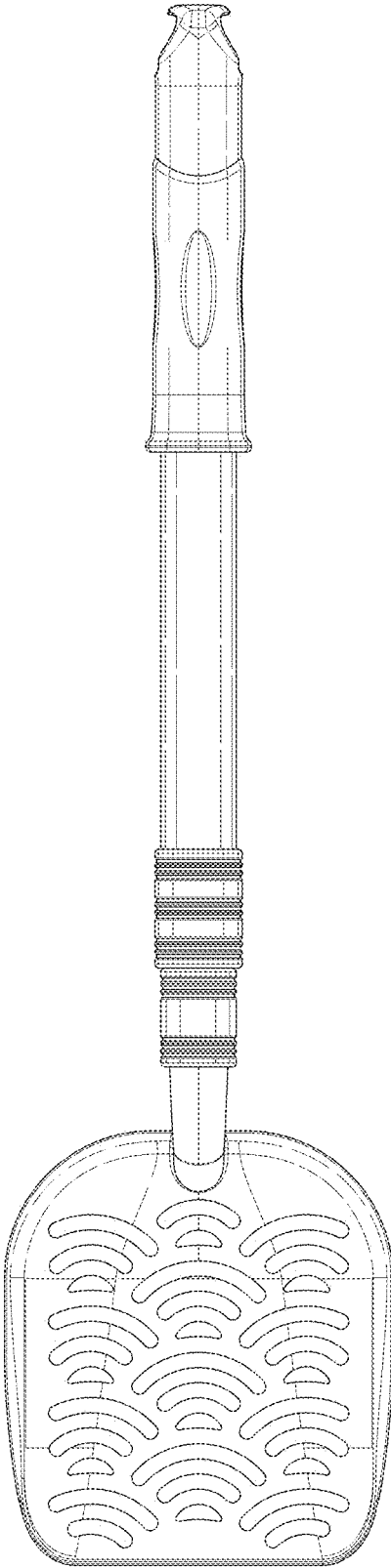

FIG. 17

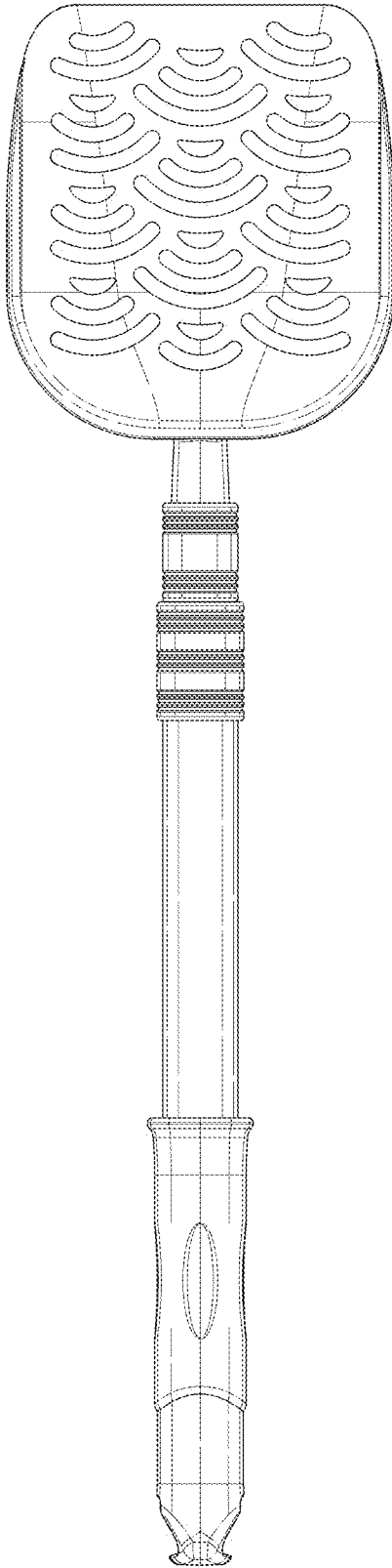

FIG. 18