



US00D464591S

(12) **United States Design Patent**
Czaja

(10) **Patent No.:** **US D464,591 S**

(45) **Date of Patent:** **** Oct. 22, 2002**

(54) **MINIATURE FLAG ENCASEMENT**

(76) **Inventor:** **Michael Czaja, 25 Winston Ave.,
Bourne, MA (US) 02532**

(**) **Term:** **14 Years**

(21) **Appl. No.:** **29/142,340**

(22) **Filed:** **May 24, 2001**

(51) **LOC (7) Cl. 11-05**

(52) **U.S. Cl. D11/166; D6/470; D11/131**

(58) **Field of Search D11/165, 166,
D11/167, 168, 169, 170, 171, 172, 173,
174, 175, 176, 177, 178, 179, 180, 181,
182, 183, 184, 108, 109, 131, 157; D19/80,
82, 94, 65; 40/218, 358, 722, 734, 745,
798; 52/120.1, 300, 301; 116/173, 174,
175; 248/127, 309.1, 511, 512, 519, 469,
510, 13; 428/542.2, 542.4, 542.6, 542.8,
913.3; D20/11, 15; D6/300, 310, 314**

(56) **References Cited**

U.S. PATENT DOCUMENTS

2,535,149	A	*	12/1950	McBride	D11/181
2,841,272	A	*	7/1958	Dreier	428/542.4
D231,994	S	*	7/1974	Demsey, Sr.	D11/182
3,955,786	A	*	5/1976	Duddy	248/539
D267,686	S	*	1/1983	Dawson	D11/181

4,879,145	A	*	11/1989	McLellan et al.	428/542.4
D315,323	S	*	3/1991	Bailey	D11/181
D318,198	S	*	7/1991	Francetic	D11/157
D319,200	S	*	8/1991	Stephenson	D11/166
D323,257	S	*	1/1992	Cornwell	D11/181
5,087,012	A	*	2/1992	Doublet	248/512
D335,784	S	*	5/1993	Guilfoil, Sr.	D11/181
D337,460	S	*	7/1993	Tannehill, II et al.	D11/131

* cited by examiner

Primary Examiner—Doris V. Coles

Assistant Examiner—Elizabeth A. Albert

(74) *Attorney, Agent, or Firm*—Thomas Kahrl, Esq.

(57) **CLAIM**

I claim the ornamental design for miniature flag encasement, as shown and described.

DESCRIPTION

FIG. 1 is a perspective view of a miniature flag encasement showing my new design;

FIG. 2 is a front elevational view thereof;

FIG. 3 is a rear elevational view thereof;

FIG. 4 is a top plan view thereof;

FIG. 5 is a left side elevational view thereof;

FIG. 6 is a right side elevational view thereof; and,

FIG. 7 is a bottom plan view thereof.

1 Claim, 3 Drawing Sheets

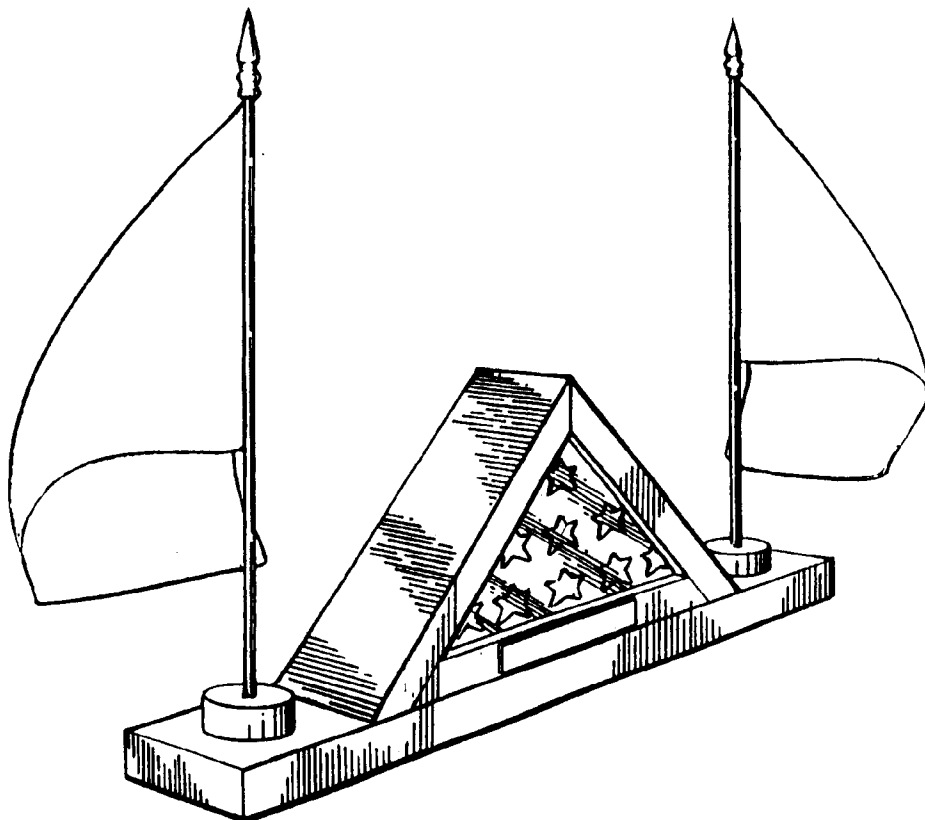

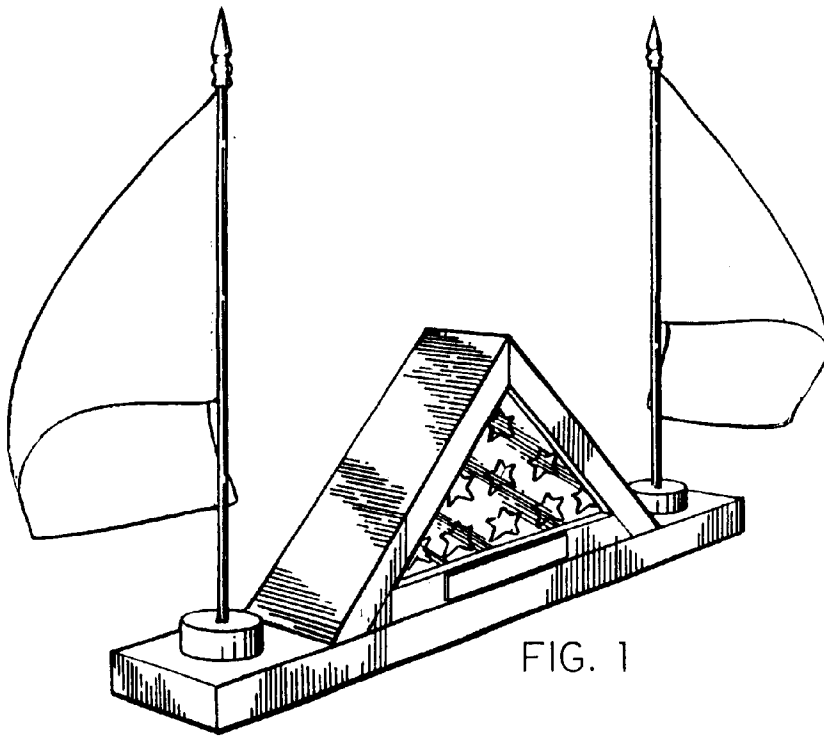

FIG. 1

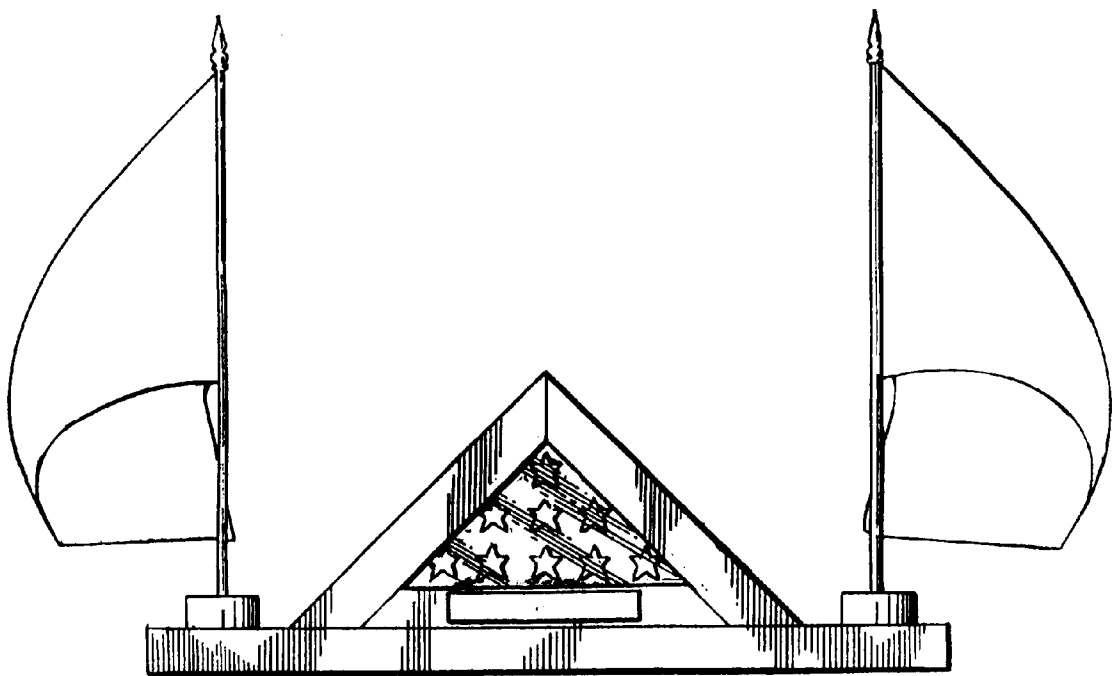

FIG. 2

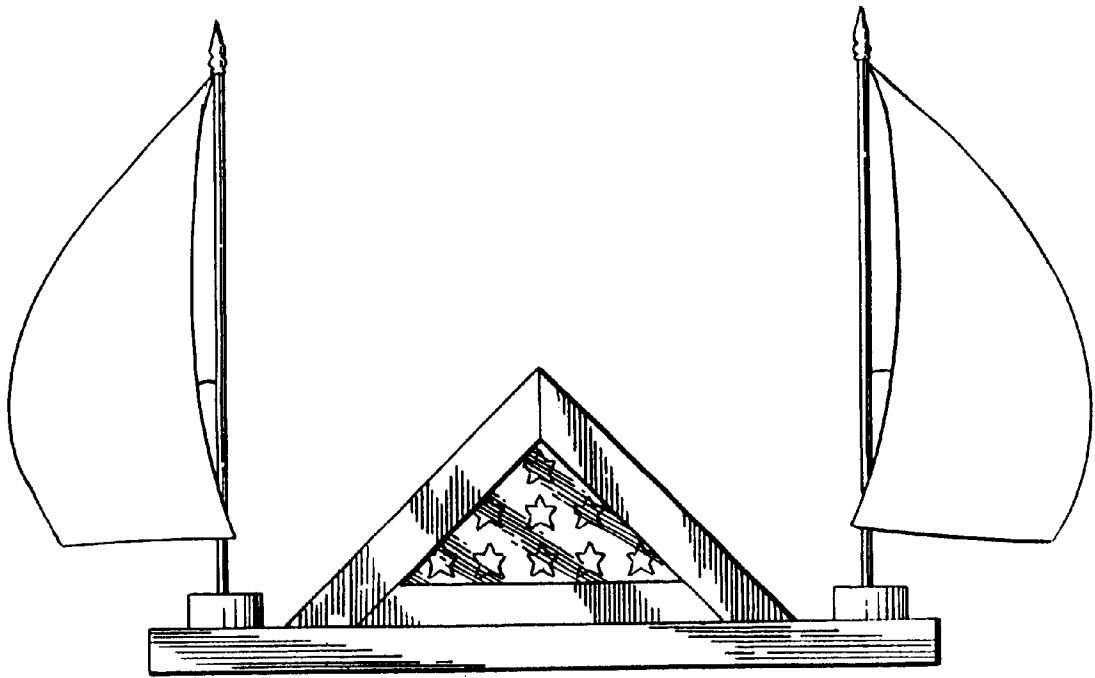

FIG. 3

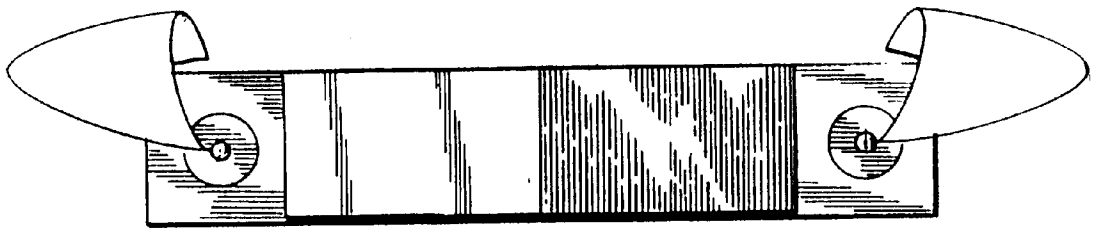

FIG. 4

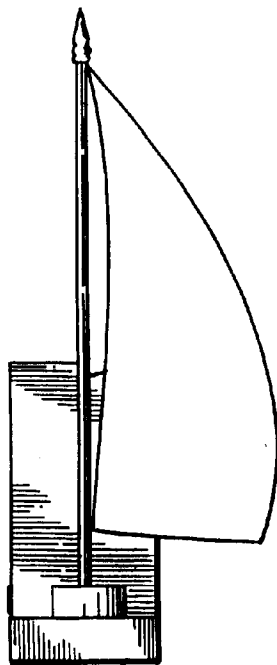

FIG. 5

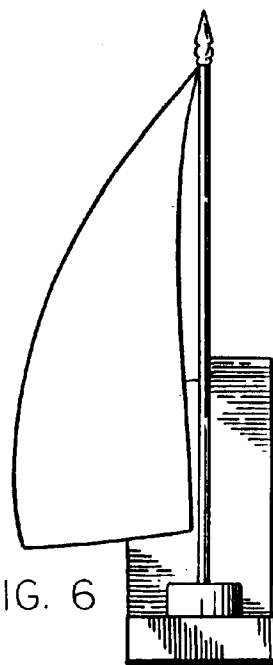

FIG. 6

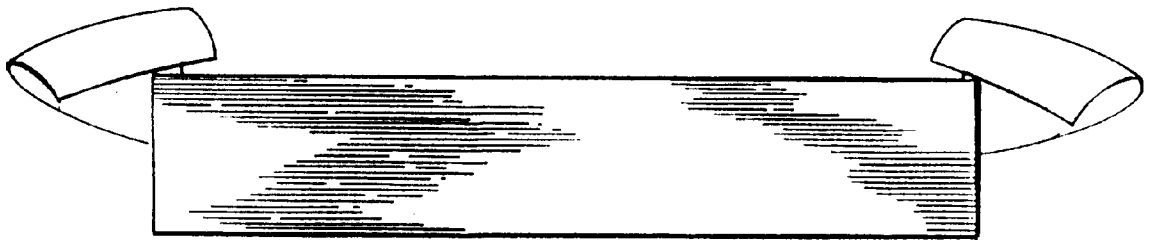

FIG. 7