



INTERNATIONAL APPLICATION PUBLISHED UNDER THE PATENT COOPERATION TREATY (PCT)

<p>(51) International Patent Classification ⁶ : G06F 3/033</p>	<p>A1</p>	<p>(11) International Publication Number: WO 99/28813 (43) International Publication Date: 10 June 1999 (10.06.99)</p>
<p>(21) International Application Number: PCT/IB98/01929 (22) International Filing Date: 3 December 1998 (03.12.98) (30) Priority Data: 08/985,265 4 December 1997 (04.12.97) US (71) Applicant: NORTHERN TELECOM LIMITED [CA/CA]; Station A, P.O. Box 6123, Montreal, Quebec H3C 3J5 (CA). (72) Inventors: BEATON, Brian, Finlay; 6136 SilverBirch Street, Orleans, Ontario K1W 1C4 (CA). SMITH, Colin, Donald; 565 Athlone Avenue, Ottawa, Ontario K1Z 5N1 (CA). STALKIE, Bruce, Dale; 63 Beamish Crescent, Kanata, Ontario K2K 2R7 (CA).</p>	<p>(81) Designated States: BR, CA, CN, IL, JP, KR, MX, VN, European patent (AT, BE, CH, CY, DE, DK, ES, FI, FR, GB, GR, IE, IT, LU, MC, NL, PT, SE). Published <i>With international search report.</i></p>	

(54) Title: NAVIGATION TOOL FOR GRAPHICAL USER INTERFACE

(57) Abstract

The system and method consistent with the present invention provides improved graphical navigation tool for electronic devices. The graphical navigation tools may be used to navigate through documents at any direction at varying speeds. The navigation tool is preferably transparent to prevent obscuring the text of the underlying document. Accordingly, the navigational tool does not take up additional screen real estate. The GUI of the present invention may be especially useful in portable electronic devices with small displays.



FOR THE PURPOSES OF INFORMATION ONLY

Codes used to identify States party to the PCT on the front pages of pamphlets publishing international applications under the PCT.

AL	Albania	ES	Spain	LS	Lesotho	SI	Slovenia
AM	Armenia	FI	Finland	LT	Lithuania	SK	Slovakia
AT	Austria	FR	France	LU	Luxembourg	SN	Senegal
AU	Australia	GA	Gabon	LV	Latvia	SZ	Swaziland
AZ	Azerbaijan	GB	United Kingdom	MC	Monaco	TD	Chad
BA	Bosnia and Herzegovina	GE	Georgia	MD	Republic of Moldova	TG	Togo
BB	Barbados	GH	Ghana	MG	Madagascar	TJ	Tajikistan
BE	Belgium	GN	Guinea	MK	The former Yugoslav Republic of Macedonia	TM	Turkmenistan
BF	Burkina Faso	GR	Greece	ML	Mali	TR	Turkey
BG	Bulgaria	HU	Hungary	MN	Mongolia	TT	Trinidad and Tobago
BJ	Benin	IE	Ireland	MR	Mauritania	UA	Ukraine
BR	Brazil	IL	Israel	MW	Malawi	UG	Uganda
BY	Belarus	IS	Iceland	MX	Mexico	US	United States of America
CA	Canada	IT	Italy	NE	Niger	UZ	Uzbekistan
CF	Central African Republic	JP	Japan	NL	Netherlands	VN	Viet Nam
CG	Congo	KE	Kenya	NO	Norway	YU	Yugoslavia
CH	Switzerland	KG	Kyrgyzstan	NZ	New Zealand	ZW	Zimbabwe
CI	Côte d'Ivoire	KP	Democratic People's Republic of Korea	PL	Poland		
CM	Cameroon	KR	Republic of Korea	PT	Portugal		
CN	China	KZ	Kazakstan	RO	Romania		
CU	Cuba	LC	Saint Lucia	RU	Russian Federation		
CZ	Czech Republic	LI	Liechtenstein	SD	Sudan		
DE	Germany	LK	Sri Lanka	SE	Sweden		
DK	Denmark	LR	Liberia	SG	Singapore		
EE	Estonia						

- 1 -

NAVIGATION TOOL FOR GRAPHICAL USER INTERFACE

Description

RELATED APPLICATIONS

This application is related to U.S. patent application, Serial No. 08/985,264 (Atty. Docket No. 3884.0116-00), entitled INTELLIGENT TOUCH DISPLAY; and U.S. patent application, Serial No. 08/985,261 (Atty. Docket No. 3884.0117-00), entitled CONTEXTUAL GESTURE INTERFACE, both of which are filed concurrently herewith, and both of which are hereby incorporated by reference.

BACKGROUND OF THE INVENTION

The present invention relates generally to graphical user interfaces (GUI), and more particularly to a navigation tool for graphical user interfaces.

Until relatively recently, software-based documents have been primarily viewed and manipulated on desktop or laptop computers with relatively large displays, typically 640 x 480 pixels or larger. These displays are often large enough to display a full page of standard size page or at least a significant portion of the page. Hence, on-screen graphical menus and controls displayed in window of an application did not greatly reduce the display area for the underlying document. Computers also have peripheral devices such as a keyboard or a mouse to control the display of content information. Thus, viewing and navigating around a single-page or multi-page document have not posed much difficulty.

Due to increasing focus on compactness of electronic devices, however, the displays especially in portable electronic devices are becoming smaller and smaller. Popular electronic devices with smaller display area include electronic organizers, PDA's (personal digital assistants), and graphical display-based telephones. Also available today are communicators that facilitate various types of communication such as voice, faxes, SMS (Short Messaging Services)

- 2 -

messages, e-mail, and Internet-related applications. These products can likewise only contain a small display area.

To enable users to navigate around a full page of content information, these devices typically provide hard-keys for arrows as shown in Fig. 1. The hard-keys, however, not only increase the size but also add to the cost of the devices. Also, hard-keys generally provide limited options for direction of movement, *e.g.*, vertical or horizontal. They generally do not provide the freedom to move in any direction.

Some displays of these devices also require a separate stylus having peripheral technology that requires transmission of electromagnetic pulses or light to the display. These devices often require additional controllers such as buttons on the body or the tip of the stylus for activation. Furthermore, these styli require a power source, either through wire or battery, and their compatibility is generally limited to a specific device.

As shown in Fig. 2, other devices substitute hard-keys with graphical on-screen arrows or scroll bars that are typically used in full-size computer displays. The on-screen scroll bars, however, occupy valuable screen real estate and compound the limitations of small displays. Similar to the hard-keys, the on-screen arrows also generally restrict the navigational movement to horizontal or vertical direction.

In other forms of on-screen GUIs, *e.g.*, pop-up menus, also take up valuable screen space, further reducing the available display area for content information. Additionally, on-screen pop-up menus typically provide available functions in multiple layers, thus requiring a user to move deeply into the hierarchy before reaching the desired function. This is time consuming and renders the GUI cumbersome and ineffective.

Therefore, it is desirable to provide navigation tools that allow small-size devices while maximizing the use of available screen real estate.

It is also desirable to provide tools to navigate within a document at any direction at varying speeds.

- 3 -

It is further desirable to provide navigation tools that can be activated without requiring specific electronic devices.

In addition, it is further desirable to provide an improved GUI that simplifies GUI by recognizing various characteristics of the touch input.

SUMMARY OF THE INVENTION

Systems and methods consistent with the present invention provide graphical control tools for efficient navigation in display devices.

Specifically, a method consistent with this invention of controlling display of content information in a physical viewing area comprises several steps. Initially, the system displays the content information in the physical viewing area. The system also displays a representation of a control tool over the display of content information. Thereafter, the system receives a user input selecting the control tool, and controls the display of content information according to the user input.

A system consistent for this invention for controlling display of content information in a physical viewing area includes displaying means, receiving means, and controlling means. The displaying means displays the content information in the physical viewing area, and displays a representation of a control tool over the display of content information. The receiving means receives a user input selecting the control tool. Thereafter, the controlling means controls the display of the content information according to the user input.

BRIEF DESCRIPTION OF THE DRAWINGS

The accompanying drawings, which are incorporated in and constitute a part of this specification, illustrate the invention and together with the description, serve to explain the principles of the invention.

In the drawings,

Fig. 1 shows conventional hard-key arrows for navigation control;

Fig. 2 shows conventional on-screen graphical navigation tool;

Figs. 3A-3B are diagrams of an exemplary mobile telephone consistent with the principles of the present invention;

- 4 -

Fig. 4 is a block diagram showing the elements of the mobile telephone of Fig. 3A;

Fig. 5 is a block diagram showing the components of the memory of Fig. 4;

Fig. 6 is a block diagram of touch screen functionalities;

Figs. 7A-7B show an exemplary inactive and active graphical navigation tool, respectively;

Fig. 8 is a sample screen showing an active navigation tool;

Figs. 9A-9C show exemplary features of the navigation tool;

Figs. 10A-10C are sample screens showing the navigation tool performing various navigation functions;

Figs. 11A-11B show exemplary features of the navigation tool relating to speed of navigation;

Fig. 12 is a diagram illustrating a touch point distribution; and

Fig. 13 is a flowchart illustrating the process of determining the size of the object making contact with the viewing area.

Figs. 14A and 14B are graphs showing the touch characteristics of a pen and a finger, respectively.

DESCRIPTION OF THE PREFERRED EMBODIMENT

Reference will now be made in detail to the present preferred embodiment of the invention, an example of which is illustrated in the accompanying drawings. Where appropriate, the same reference numerals refer to the same or similar elements. The appended claims define the scope of the invention; the following description does not limit that scope.

The graphical navigation tool of the present invention may be implemented in a wide range of electronic devices mentioned above such as electronic organizers, PDA's, and graphical display-based telephones. Although the need to maximize the use of screen real estate is most critical in portable electronic devices with small displays, the present invention can also be implemented in full-size computers or electronic devices. For purposes of

- 5 -

illustration, however, the present invention will be explained in detail in a mobile telephone environment.

Specifically, Fig. 3A shows a mobile telephone 310 and Fig. 3B shows an exemplary wireline telephone preferably having the graphical navigation tool consistent with the present invention. Mobile telephone 310 includes main housing 310, antenna 320, keypad 330, and display 340. Fig. 4 shows the hardware elements in mobile telephone 310 including antenna 410, communications module 420, feature processor 430, memory 440, sliding keypad 450, analog controller 460, display module 470, battery pack 480, and switching power supply 490.

Antenna 410 transmits and receives radio frequency information for mobile telephone 210. Antenna 410 preferably comprises a planar inverted F antenna (PIFA)-type or a short stub (2 to 4 cm) custom helix antenna. Antenna 410 communicates over a GSM (Global System for Mobile Communications) switching fabric using a conventional voice B-channel, data B-channel, or GSM signaling channel connection.

Communications module 420 connects to antenna 410 and provides the GSM radio, baseband, and audio functionality for mobile telephone 310. Communications module 420 includes GSM radio 421, VEGA 423, BOCK 425, and audio transducers 427.

GSM radio 421 converts the radio frequency information to/from the antenna into analog baseband information for presentation to VEGA 423. VEGA 423 is preferably a Texas Instruments VEGA device, containing analog-to-digital (A/D)/digital-to-analog (D/A) conversion units 424. VEGA 423 converts the analog baseband information from GSM radio 421 to digital information for presentation to BOCK 425.

BOCK 425 is preferably a Texas Instruments BOCK device containing a conventional ARM microprocessor and a conventional LEAD DSP device. BOCK 425 performs GSM baseband processing for generating digital audio signals and supporting GSM protocols. BOCK 425 supplies the digital audio signals to VEGA 423 for digital-to-analog conversion. VEGA 423 applies the

- 6 -

analog audio signals to audio transducers 427. Audio transducers 427 include speaker 428 and microphone 429 to facilitate audio communication by the user.

Feature processor 430 provides GUI features and a Java Virtual Machine (JVM). Feature processor 430 communicates with BOCK 425 using high level messaging over an asynchronous (UART) data link. Feature processor 430 contains additional system circuitry, such as a liquid crystal display (LCD) controller, timers, UART and bus interfaces, and real time clock and system clock generators (not shown).

Memory 440 stores data and program code used by feature processor 430. Memory 440 includes static RAM 442 and flash ROM 444. Static RAM 442 is a volatile memory that stores data and other information used by feature processor 430. Flash ROM 444, on the other hand, is a non-volatile memory that stores the program code executed by feature processor 430.

Sliding keypad 450 enables the user to dial a telephone number, access remote databases, and manipulate the GUI features. Sliding keypad 450 preferably includes a mylar resistive key matrix that generates analog resistive voltage in response to actions by the user. Sliding keypad 450 preferably connects to main housing 310 (Fig. 4) of mobile telephone 210 through two mechanical "push pin"-type contacts.

Analog controller 460 is preferably a Phillips UCB1100 device that acts as an interface between feature processor 430 and sliding keypad 450. Analog controller 460 converts the analog resistive voltage from sliding keypad 450 to digital signals for presentation to feature processor 430.

Display module 470 preferably includes a 160 x 320 pixel LCD 472 with an analog touch screen panel 474 and an electroluminescent backlight. LCD 472 operates in conjunction with feature processor 430 to display the GUI features. Analog controller 460 scans touch screen overlay 474 while feature processor 430 refreshes LCD 472.

Battery pack 480 is preferably a single lithium-ion battery with active protection circuitry. Switching power supply 490 ensures highly efficient use of the lithium-ion battery power by converting the voltage of the lithium-ion battery

- 7 -

into stable voltages used by the other hardware elements of mobile telephone 210.

Fig. 5 is a block diagram illustrating the components of memory 440. Static RAM 442 stores data and other information used by feature processor 430. Flash ROM 444 contains various programs including a program 510, a touch screen program 520, a navigation program 530, and a drawing program 540. Program 520, preferably written in languages such as Java, C, or C++ for Macintosh, is a main program overseeing the operation of mobile telephone 310.

Touch screen program 520 facilitates processing of touch input on touch screen panel 474 using a typical touch input algorithm. Navigation program 530 handles navigation of the content information display. Drawing program 540 is a graphical drawing package. Programs 520, 530, and 540 may be one of any commercially available packages or a user-defined feature program or macro.

The present invention provides various features through tactile GUI. Initially, LCD 472 displays various GUI features. Referring to Fig. 6, a user touches touch screen panel 474 to provide user input, for example, to navigate around a document or invoke a desired function. Analog controller 460 scans touch screen panel 474 and reads the corresponding analog voltage of touch screen panel 474. Analog controller 460 then converts the analog values into corresponding digital values representing the Cartesian coordinates, which are transmitted to feature processor 430 for processing. The resolution of the touch input depends on the ability of analog controller 460 to discern among multiple levels of analog values, generally defined in bits.

Figs. 7A-7B show an exemplary graphical navigation tool preferably used to navigate around documents that are too large to view within a single screen of a physical display (hereinafter referred as "viewing area"). The navigation tool may be used to view any kind of document including faxes, Web pages, or e-mail. In one embodiment consistent with the present invention, an inactive navigation tool is displayed and accessible to the user at all times (Fig. 7A). The user may activate the navigation tool by touching and holding the center of the navigation tool for a predetermined time period, for example, one to two seconds

- 8 -

(Fig. 7B). An activated navigation tool is preferably transparent to avoid hindering the display of content information in the viewing area as shown in Fig. 8. Alternatively, the navigation star may change colors or other features of its appearance to indicate its active status. A solid line image, for example, may be used in greyscale displays that do not support transparency.

The present invention may be designed such that feature processor 430 ignores any touch input on the navigation tool unless the navigation tool has been activated. Instead, the touch input may be interpreted as input to access control buttons in the underlying document, write on the underlying document, or invoke other functions related to the underlying document. This will prevent against unintentional navigation in the viewing window in case the user inadvertently touches touch screen panel 474. In an alternative embodiment, the present invention may accept stylus input to access the underlying document while a finger or non-electromagnetic touch on any part of the navigation tool invokes the navigation function.

Referring to Figs. 9A-9C, once the navigation tool is activated, the user may navigate through the document by selecting the graphical arrows, *e.g.*, up, right, left, and down arrows (Fig. 9A), or graphical page icons, *e.g.*, previous or next page (Fig. 9B). One skilled in the art may vary the type and number of graphical tools significantly. For example, the navigation tool may provide graphical representations for forward, next document, back, or home functions (Fig. 9C).

Figs. 10A-10C show exemplary screen displays while the user is touching the navigation tool. Upon touching the right arrow of the navigation tool, for example, the right arrow is highlighted and navigation program 530 moves the display to the right (Fig. 10A). Similarly, touching the down arrow moves the display down (Fig. 10B). Although the four arrows are presented to guide the users, navigation program 530 supports navigational movement at any direction. If the user touches an area of the navigation tool equidistant between the up and right arrows, for example, navigation program 530 will move the display towards the upper-right portion of the underlying document at a 45-degree angle.

- 9 -

Touching the arrows or any area in between, moves the display in the selected direction until navigation program 530 reaches the edge of the page.

Touching the next page icon moves the viewing window to the next page of the underlying document (Fig. 10C). If a particular document does not have a page corresponding to a previous or next page icon, navigation program 530 will not display the respective previous or next page icons. This would apply to one-page documents, or when the user is at the beginning or end of a multi-page document. In one embodiment consistent with the present invention, a momentary touch of the next page icon causes navigation program 530 to jump to the next page while a continuous touch on the next page icon causes navigation program 530 to continue scrolling through succeeding pages of the underlying document. The previous page icon may embody similar characteristics.

The user may also control the speed of the navigation. As shown in Fig. 11A, the speed of the navigation accelerates as the user touch moves from the center of the circle toward the circumference of the circle, *i.e.*, tip of the arrow. Hence, the viewing window moves slowly when the user touches the blunt end of the arrow located at the center of the circle while the speed accelerates as the user moves the finger towards the tip of the arrow. The speed of navigation, therefore, is determined by the distance of the touch relative to the center of the circle. Likewise, similar principles apply to previous or next page/document icons where a touch closer to the outer edge of the previous or next page/document icons accelerates navigation through the document as shown in Fig. 11B.

Although the exemplary transparent tool discussed above is for navigation, transparent control tools may be implemented for a variety of functions. A transparent tool may, for example, be used for a Web browser application where the controls may be used for appropriate functions such as moving forwards or backwards through different Web pages or returning to home page. One skilled in the art may easily vary the design or the functionality of the

- 10 -

graphical navigation tools described above without departing from the scope of the present invention.

In an exemplary embodiment of a navigation tool described above, a finger touch invokes navigational functions based on the feature selected and the location of the user touch. Alternatively, other objects making contact with touch screen panel 474 may invoke other tools or functions. A pointy stylus touch, for example, may invoke a menu with cardinal points representing multiple line widths, colors, or patterns.

In another embodiment consistent with the present invention, tools or application programs may be stored in flash ROM 444 to provide related interfaces to the user. The use of a finger may, for example, invoke tools or dialogues that are finger-touchable and large whereas the use of a sharp stylus may invoke a modified GUI with smaller touch targets. In a yet another embodiment, in a document viewing application normally navigable by a finger touch, use of a sharp stylus may automatically invoke a document annotation application for marking up the underlying document.

As described above, the touch-responsive GUI of the present invention are facilitated through various components including touch screen panel 474, analog controller 460, and feature processor 430. Specifically, analog controller 460 scans touch screen panel 474 to read the corresponding analog voltage of touch screen panel 474 activated by a user touch. Analog controller 460 then converts the analog values into a digital value representing the Cartesian coordinates, which is transmitted to feature processor 430 for processing according to the functionalities of the present invention.

When a user touches touch screen panel 474, program 510 initiates touch screen program 520 to determine the pointer size of the object making contact with touch screen panel 474 based on a touch point distribution or pointer size of the touch input. As shown in Fig. 12, touch screen program 520 can, for example, determine whether the pointer size of the object is a finger or a sharp object.

- 11 -

Fig. 13 is a flowchart illustrating the process of determining the size of the object making contact with the viewing area. Touch point program 520 first determines the individual points of contact made by the object (step 1310). It computes a centroid, or other average point, of the determined points of contact (step 1320). Touch program 520 then computes a standard deviation of the centroid as well as the variance (step 1330), and determines the pointer size based on the centroid and the standard deviation (step 1340). These computations are preferably performed on a real-time basis to provide immediate system response to the touch input. In order to achieve optimum results and accuracy, analog touch controller 460 preferably generates 150 points per second or more. Touch program 520 may also use the amount of pressure imposed on touch screen panel 474 as a function of time to determine the size of object. As shown in Fig. 14A, for example, if the amount of pressure increases or decreases sharply at a particular instant in time, touch point program 520 may determine that the touch corresponds to a pen. A finger touch, on the other hand, results in a gradual increase and decrease in pressure as illustrated by a smoother curve in Fig. 14B.

Program 510 can also be programmed to correlate certain pointer size to certain objects and invoke corresponding functions or tools. Such GUI provides a richer, yet simplified interaction between the user and mobile telephone 310. If program 510 determines that the pointer size of the object corresponds to the size of a finger, program 510 may initiate a navigation tool. If the pointer size corresponds to the size of several fingers, program 510 may invoke a drag function of the navigation tool. On the other hand, if program 510 determines that the pointer size of the object corresponds to size of a sharp point or pen, program 510 may initiate a drawing tool supported by drawing program 540. Similarly, if program 510 determines that the pointer size of the object corresponds to size of a pencil eraser, program 510 may initiate an erase function of the drawing tool. One skilled in the art may easily vary the functions or tools initiated by program 510. Additionally, the functions or tools may be commercial software packages, predetermined functions, or user-defined macros.

- 12 -

In addition to using the pointer size to determine the desired GUI, program 510 can also incorporate other characteristics of the user touch, *e.g.*, gestures or movements, to simplify GUI and maximize screen real estate. A gesture recognizing interface extends the ability of the present invention to distinguish between different sized pointers to track gestures and movement of user input based on vector direction and magnitude, all in the context of active user application. This type of contextual gesture interface can infer by context, the implement, and the gesture chosen by the user what functions the user wishes to invoke. Accordingly, all these functions are available without menus or scroll bars and do not require additional screen areas to display the functions.

Program 510 recognizes other characteristics of the touch input including the context of the input, namely the task or sub-task applications running when the GUI is invoked. If a user is in a document navigation application, for example, program 510 interprets a quick drag to the right as a next page function. If the underlying task is an editing application, program 510 may interpret the same gesture as a highlight function and highlight a portion of the document touched by the user. Similarly, in graphics application, a quick drag to the right may invoke a drawing tool to draw from the starting point to the ending point of the touch points. In a document viewing application, the same touch may invoke a navigation tool to move the view of the document in the direction of the finger drag.

All of the above functions and features described above focuses on providing intuitive GUIs and minimize the need for users to memorize complicated, hierarchical menus or procedures. Additionally, the present invention maximize available screen real estate while providing a wide array of GUI and tools.

It will be apparent to those skilled in the art that various modifications and variations can be made in the system of the present invention and in construction of this system without departing from the scope or spirit of the invention. Other embodiments of the invention will be apparent to those skilled

- 13 -

in the art from consideration of the specification and practice of the invention disclosed herein. The specification and examples should be considered as exemplary only, with the true scope and spirit of the invention indicated by the following claims.

- 14 -

WHAT IS CLAIMED IS:

1. A method of controlling display of content information in a physical viewing area comprising the steps of:
 - displaying the content information in the physical viewing area;
 - displaying a representation of a control tool over the display of content information;
 - receiving a user input selecting the control tool; and
 - controlling the display of content information according to the user input.

2. The method of claim 1, further including the steps of
 - receiving a user input selecting a predetermined portion of the control tool, and
 - activating the control tool in response to the user input, andwherein the controlling step includes the substep of
 - changing the display to a different portion of the content information.

3. The method of claim 1, wherein the controlling step includes the substep of
 - shifting the content information in the physical viewing area.

4. The method of claim 3, wherein the shifting step includes the substep of
 - scrolling to a different portion of the content information.

5. The method of claim 3, wherein the shifting step includes the substep of
 - jumping to a different portion of the content information.

- 15 -

6. The method of claim 1, wherein the controlling step includes the substep of
shifting the display of content information at a speed determined by to the user input.
7. The method of claim 1, wherein the control information includes a plurality of pages, and wherein the controlling step includes the substep of displaying a different one of the pages of the content information.
8. The method of claim 1, wherein the step of displaying the control tool includes the substep of
displaying the control tool containing arrows indicating direction.
9. The method of claim 1, wherein the control information includes a document and
wherein the step of displaying the control tool includes the substep of
displaying the control tool indicating various functions related to the document.
10. The method of claim 1, wherein the step of displaying the control tool includes the substep of
displaying a transparent control tool.
11. The method of claim 1, wherein the step of displaying the control tool includes the substep of
displaying an opaque control tool.
12. An apparatus for controlling display of content information in a physical viewing area comprising:
means for displaying the content information in the physical viewing area;

- 16 -

means for displaying a representation of a control tool over the display of content information;

means for receiving a user input selecting the control tool; and

means for controlling the display of the content information according to the user input.

13. The apparatus of claim 12, further including

means for receiving a user input selecting a predetermined portion of the control tool, and

means for activating the control tool in response to the user input, and wherein the controlling means includes

means for changing the display to a different portion of the content information.

14. The apparatus of claim 12, wherein the controlling means includes means for shifting the content information in the physical viewing area.

15. The apparatus of claim 14, wherein the shifting means includes means for scrolling to a different portion of the content information.

16. The apparatus of claim 14, wherein the shifting means includes means for jumping to a different portion of the content information.

17. The apparatus of claim 12, wherein the controlling means includes means for shifting the display of content information at a speed determined by the user input.

18. The apparatus of claim 12, wherein the content information includes a plurality of pages, and wherein the controlling means includes

- 17 -

means for displaying a different ones of the pages of the content information.

19. The apparatus of claim 12, wherein the means for displaying the control tool includes

means for displaying the control tool containing arrows indicating direction.

20. The apparatus of claim 12, wherein the content information includes a document, and

wherein the means for displaying the control tool includes

means for displaying the control tool indicating various functions related to the document.

21. The apparatus of claim 12, wherein the means for displaying the control tool includes

means for displaying a transparent control tool.

22. The apparatus of claim 12, wherein the means for displaying the control tool includes

means for displaying an opaque control tool.

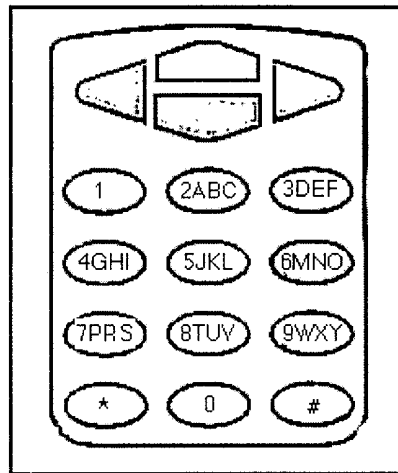

Fig.1

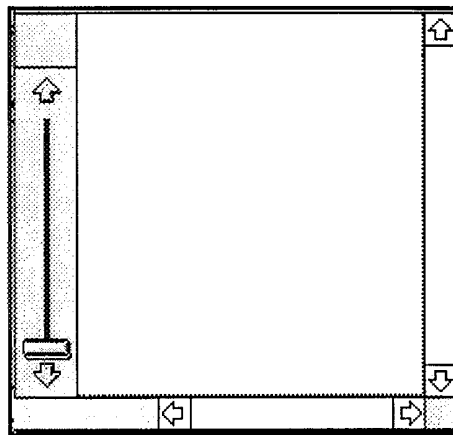
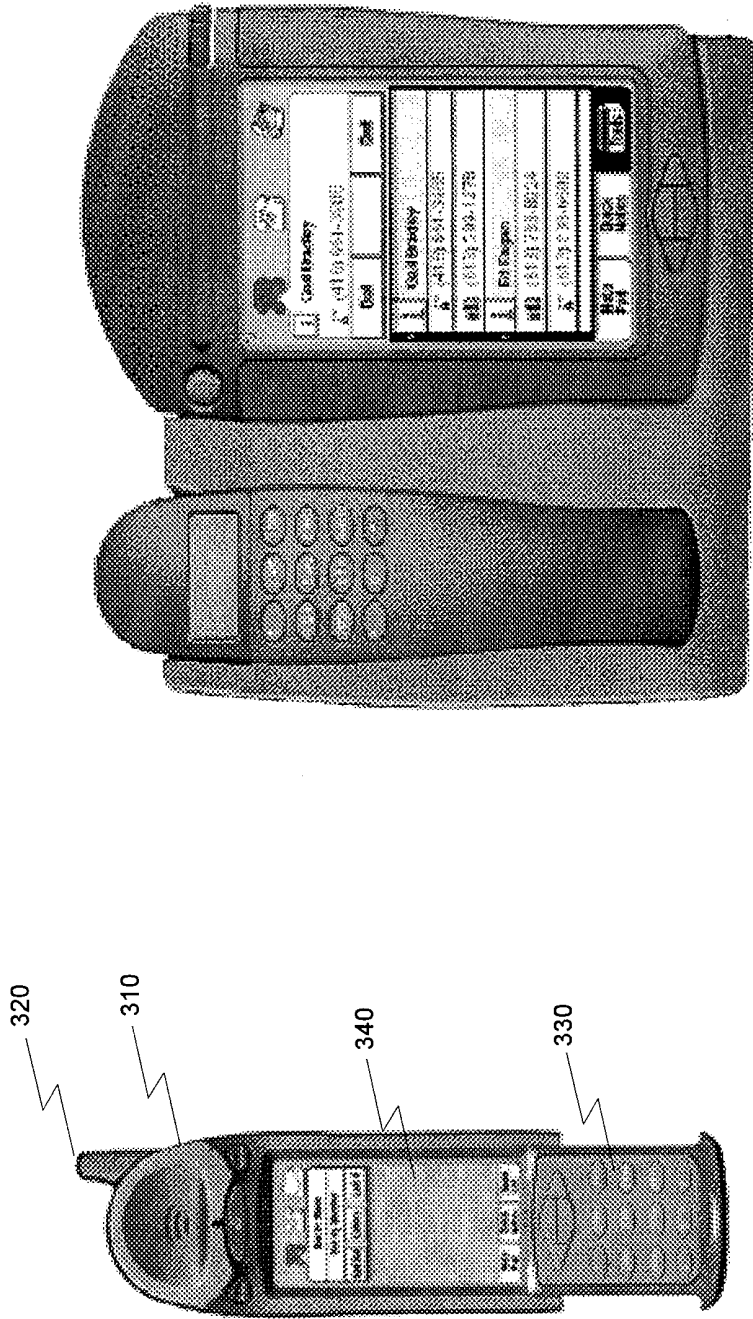

Fig. 2



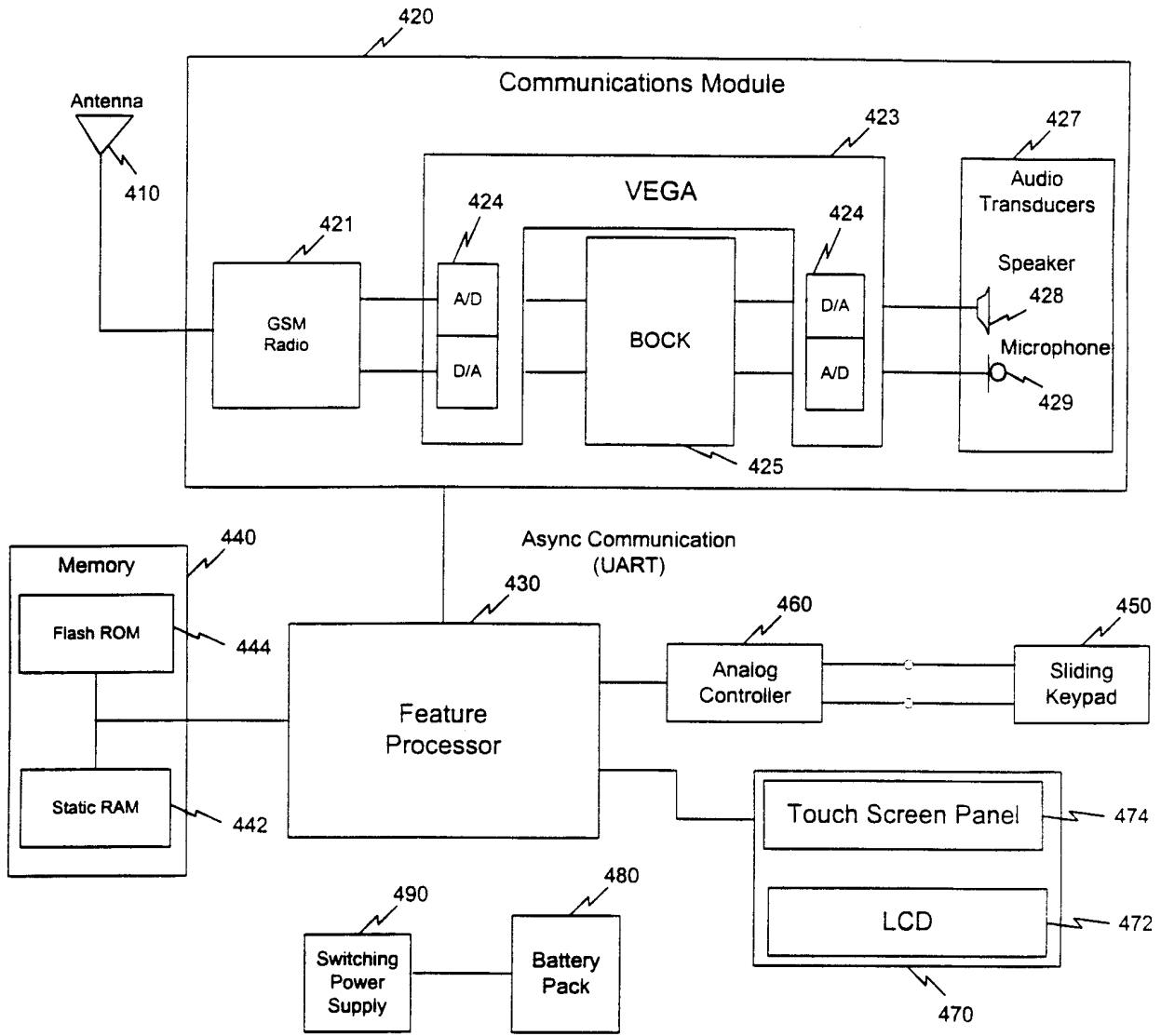

Fig. 4

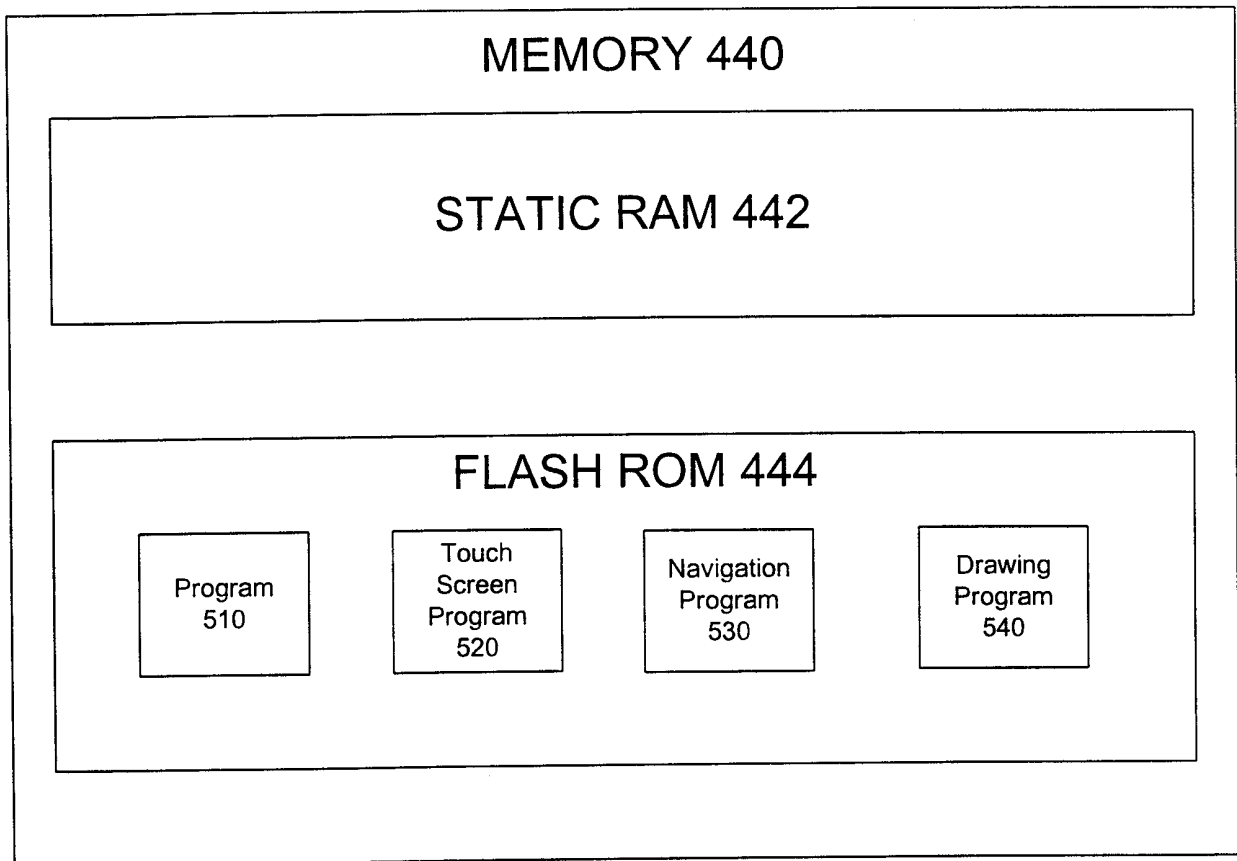

Fig. 5

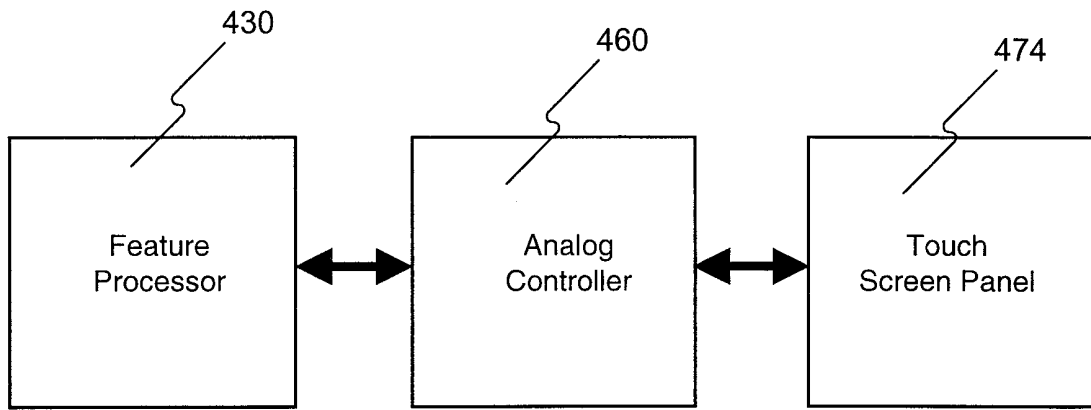

Fig. 6

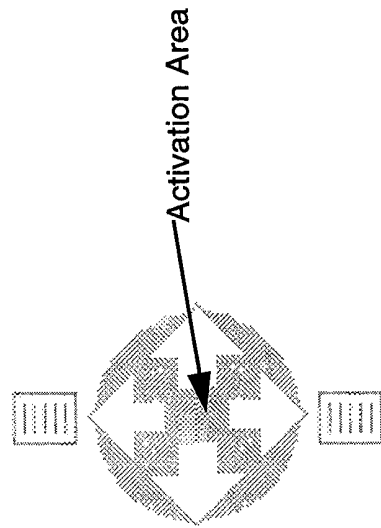

Fig. 7B

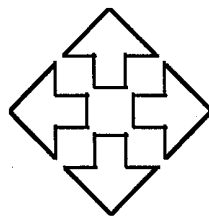

Fig. 7A



Fig. 8

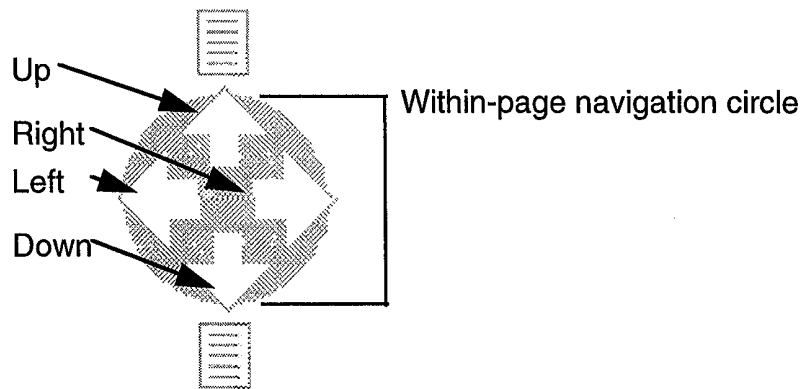

Fig. 9A

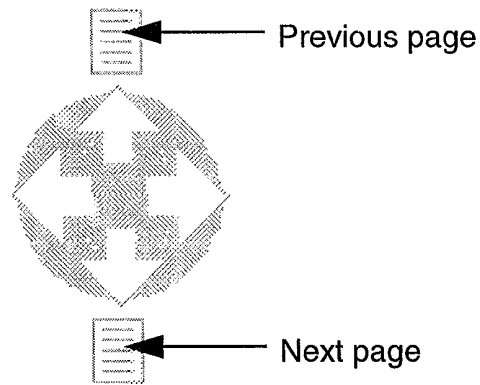

Fig. 9B

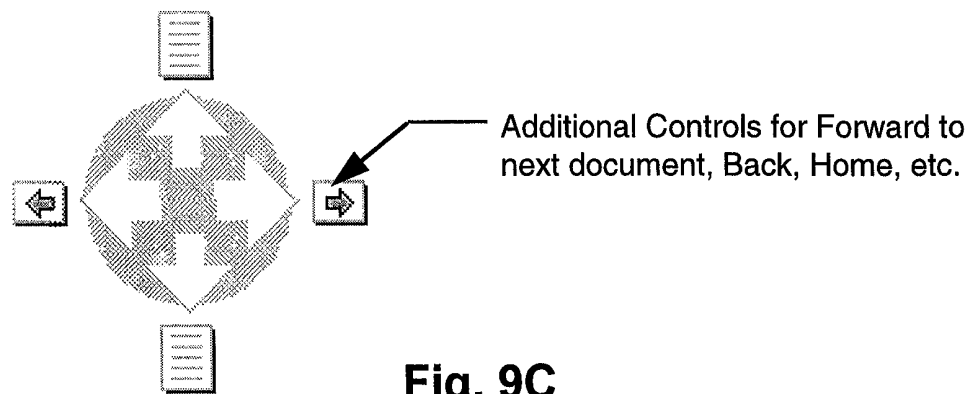

Fig. 9C

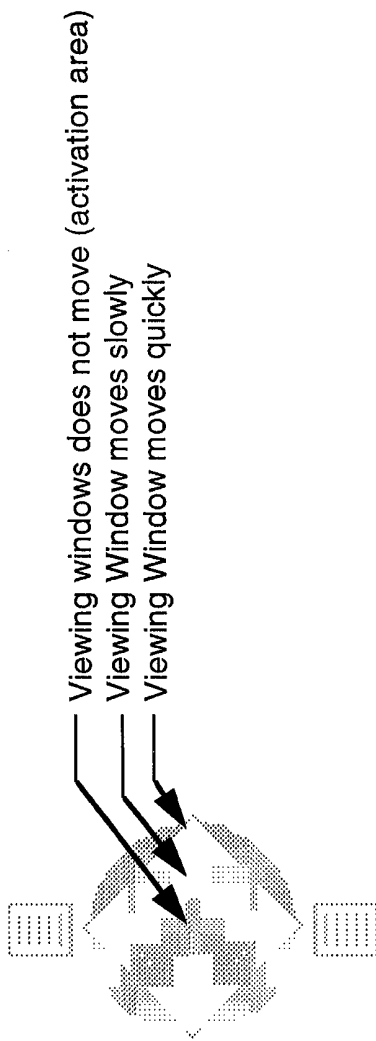

Fig. 11A

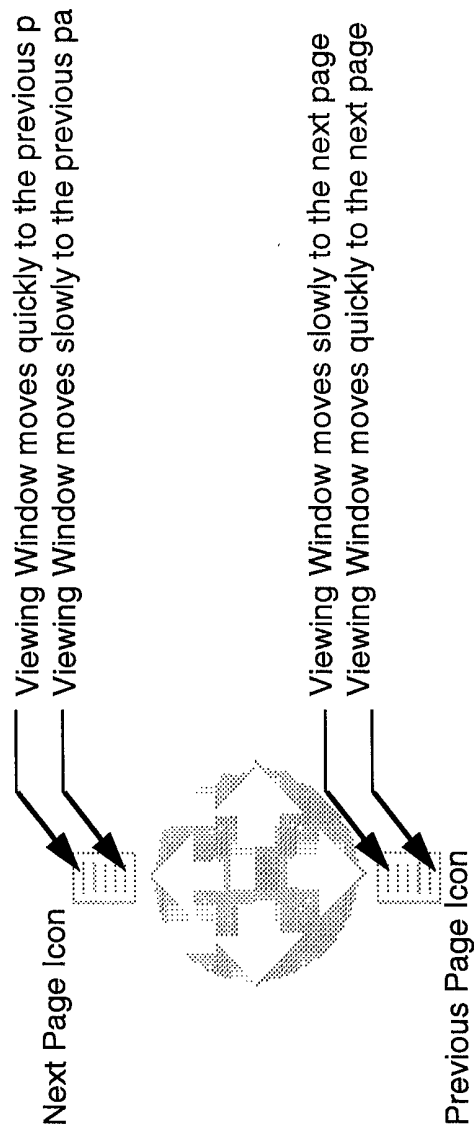

Fig. 11B

Touch point distribution



Fig. 12

13/14

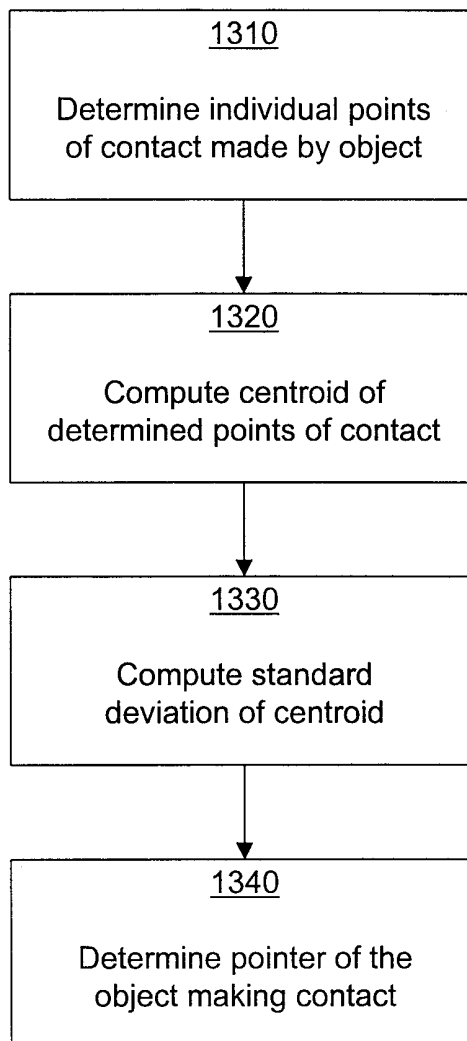
**Fig. 13**

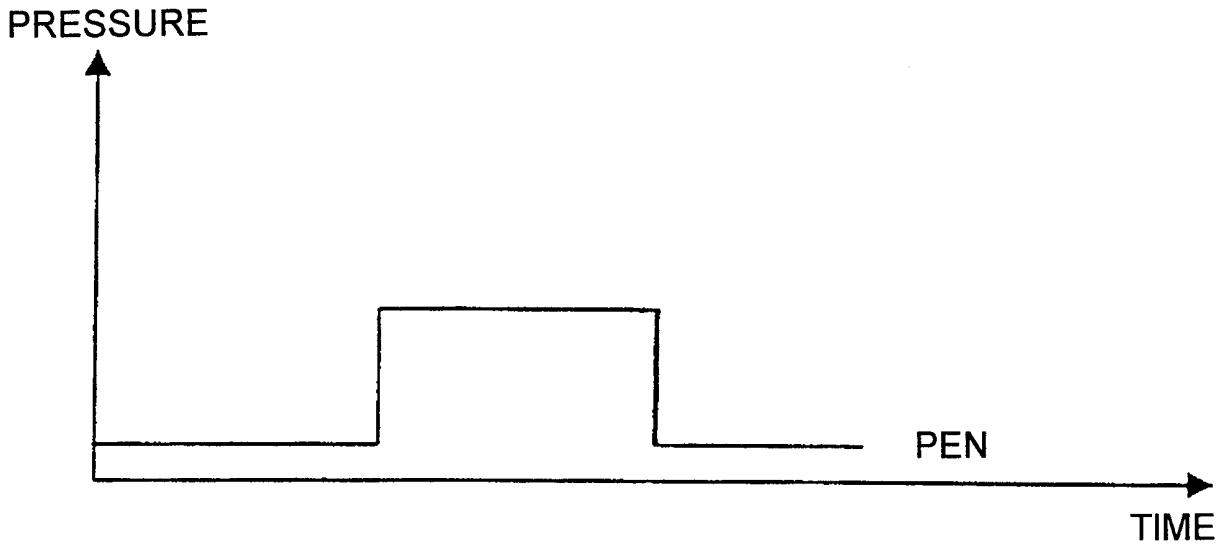

FIG. 14A

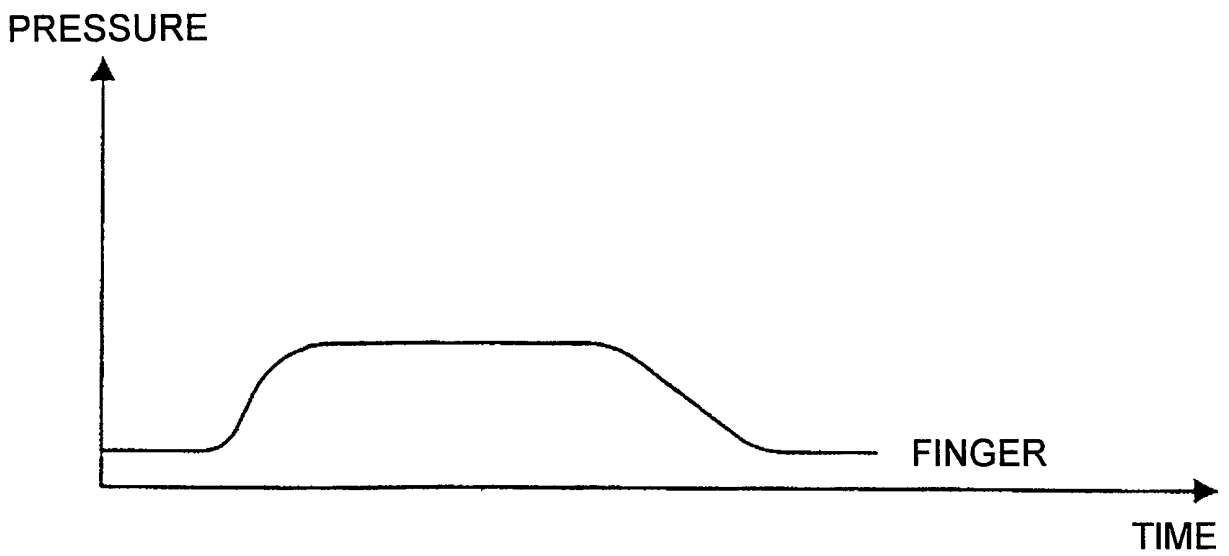

FIG. 14B

INTERNATIONAL SEARCH REPORT

International Application No

PCT/IB 98/01929

A. CLASSIFICATION OF SUBJECT MATTER
IPC 6 G06F3/033

According to International Patent Classification (IPC) or to both national classification and IPC

B. FIELDS SEARCHED

Minimum documentation searched (classification system followed by classification symbols)

IPC 6 G06F

Documentation searched other than minimum documentation to the extent that such documents are included in the fields searched

Electronic data base consulted during the international search (name of data base and, where practical, search terms used)

C. DOCUMENTS CONSIDERED TO BE RELEVANT

Category °	Citation of document, with indication, where appropriate, of the relevant passages	Relevant to claim No.
X	"SCROLL CONTROL BOX" IBM TECHNICAL DISCLOSURE BULLETIN, vol. 36, no. 4, 1 April 1993, pages 399-403, XP000364559 see the whole document ---	1-8, 11-19,22
X	US 5 592 195 A (IWANO KAZUO ET AL) 7 January 1997 see abstract see column 9, line 42 - column 13, line 43; figures 7-8F see column 15, line 13 - line 20 see column 15, line 28 - line 36; figure 13 --- -/--	1-6,8, 11-17, 19,22

Further documents are listed in the continuation of box C.

Patent family members are listed in annex.

° Special categories of cited documents :

- "A" document defining the general state of the art which is not considered to be of particular relevance
- "E" earlier document but published on or after the international filing date
- "L" document which may throw doubts on priority claim(s) or which is cited to establish the publication date of another citation or other special reason (as specified)
- "O" document referring to an oral disclosure, use, exhibition or other means
- "P" document published prior to the international filing date but later than the priority date claimed

- "T" later document published after the international filing date or priority date and not in conflict with the application but cited to understand the principle or theory underlying the invention
- "X" document of particular relevance; the claimed invention cannot be considered novel or cannot be considered to involve an inventive step when the document is taken alone
- "Y" document of particular relevance; the claimed invention cannot be considered to involve an inventive step when the document is combined with one or more other such documents, such combination being obvious to a person skilled in the art.
- "&" document member of the same patent family

Date of the actual completion of the international search

1 March 1999

Date of mailing of the international search report

08/03/1999

Name and mailing address of the ISA

European Patent Office, P.B. 5818 Patentlaan 2
NL - 2280 HV Rijswijk
Tel. (+31-70) 340-2040, Tx. 31 651 epo nl,
Fax: (+31-70) 340-3016

Authorized officer

Bravo, P

INTERNATIONAL SEARCH REPORT

International Application No

PCT/IB 98/01929

C.(Continuation) DOCUMENTS CONSIDERED TO BE RELEVANT		
Category	Citation of document, with indication, where appropriate, of the relevant passages	Relevant to claim No.
X	<p>EP 0 565 253 A (NCR INT INC) 13 October 1993</p> <p>see column 4, line 16 - column 54; figures 7-11H</p> <p>---</p>	<p>1-4, 8, 10, 12-15, 19, 21</p>
X	<p>US 4 954 967 A (TAKAHASHI) 4 September 1990</p> <p>see abstract see column 1, line 54 - column 2, line 5 see column 2, line 59 - column 3, line 21; figure 6A see column 3, line 62 - line 64</p> <p>---</p>	<p>1-4, 6, 8, 11-15, 17, 19, 22</p>
A	<p>EP 0 684 543 A (IBM) 29 November 1995</p> <p>see abstract see column 2, line 55 - column 3, line 28 see column 5, line 20 - column 6, line 5; figures 5, 6 see column 6, line 33 - line 42 see column 7, line 9 - line 41</p> <p>---</p>	<p>1-9, 12-20</p>
A	<p>EP 0 605 945 A (FIRSTPERSON INC) 13 July 1994 see abstract see page 9, line 14 - line 29; figure 10</p> <p>-----</p>	<p>1</p>

INTERNATIONAL SEARCH REPORT

Information on patent family members

International Application No

PCT/IB 98/01929

Patent document cited in search report	Publication date	Patent family member(s)	Publication date
US 5592195 A	07-01-1997	NONE	
EP 0565253 A	13-10-1993	US 5297030 A	22-03-1994
		DE 69318883 D	09-07-1998
		JP 6223269 A	12-08-1994
US 4954967 A	04-09-1990	JP 1683073 C	31-07-1992
		JP 3049119 B	26-07-1991
		JP 60066298 A	16-04-1985
EP 0684543 A	29-11-1995	CA 2124028 A	21-11-1995
		JP 7325700 A	12-12-1995
		US 5664132 A	02-09-1997
EP 0605945 A	13-07-1994	DE 69315969 D	05-02-1998
		DE 69315969 T	30-07-1998
		JP 6301505 A	28-10-1994
		US 5651107 A	22-07-1997