



US00D831436S

(12) **United States Design Patent**  
**Seiders et al.**

(10) **Patent No.:** **US D831,436 S**

(45) **Date of Patent:** **\*\* Oct. 23, 2018**

(54) **BOTTLE**

(71) Applicant: **YETI Coolers, LLC**, Austin, TX (US)

(72) Inventors: **Roy Joseph Seiders**, Austin, TX (US);  
**Matthew Joseph Petrillo**, Austin, TX (US);  
**Steve Charles Nichols**, Austin, TX (US)

(73) Assignee: **YETI Coolers, LLC**, Austin, TX (US)

(\*\*) Term: **15 Years**

(21) Appl. No.: **29/604,117**

(22) Filed: **May 15, 2017**

(51) **LOC (11) Cl.** ..... **07-01**

(52) **U.S. Cl.**

USPC ..... **D7/608**

(58) **Field of Classification Search**

USPC ..... D7/603-608, 509-511; D9/500-504,  
D9/443, 516, 532, 522, 558, 549, 559,  
D9/574, 575

CPC .. A45C 11/20; F25D 3/08; F25D 3/14; A47G  
19/2205; A47G 2019/2294; A47G 19/23;  
A47G 19/2272; A47J 41/02; A47J  
41/022; A47J 41/024; A47J 41/026; A47J  
41/028; A47J 41/00; A47J 41/0077; B65D  
81/3823; B65D 81/3818; B65D 81/3846

See application file for complete search history.

(56) **References Cited**

**U.S. PATENT DOCUMENTS**

D109,331 S	4/1938	McManus et al.	
D154,378 S	7/1949	Fuller	
D177,761 S	5/1956	Reinhardt	
2,963,187 A *	12/1960	Bramming	A47J 41/02 215/12.1
3,089,603 A	5/1963	Leslie-Smith	
D224,646 S	8/1972	Vollquartz	
D235,303 S	6/1975	Boucher	

D256,651 S	9/1980	Leung et al.	
D279,346 S *	6/1985	Ruxton	D7/321
D281,567 S	12/1985	Zimmermann	
D286,604 S	11/1986	Bierlein et al.	
D286,847 S	11/1986	Zimmermann	
D287,211 S	12/1986	Weiss	
D316,371 S	4/1991	Vola	
D321,628 S	11/1991	Kobayashi et al.	

(Continued)

**FOREIGN PATENT DOCUMENTS**

CN	301110494	1/2010
CN	203987709 U	12/2014

(Continued)

**OTHER PUBLICATIONS**

United States District Court Western District of Texas Austin Division, "Second Amended Complaint," *YETI Coolers, LLC v. Sam's West, Inc., and Sam's East, Inc., and CY Top, Ltd.*, Case: 1:16-cv-00829-RP, Document #51, filed Sep. 22, 2017, 49 pages.

(Continued)

*Primary Examiner* — Terry A Wallace

(74) *Attorney, Agent, or Firm* — Banner & Witcoff, Ltd.

(57) **CLAIM**

The ornamental design for a bottle, as shown and described.

**DESCRIPTION**

FIG. 1 is a top, front, right perspective view of a bottle showing our new design;

FIG. 2 is a bottom, front, right perspective view thereof;

FIG. 3 is a front view thereof;

FIG. 4 is a rear view thereof;

FIG. 5 is a right side view thereof;

FIG. 6 is a left side view thereof;

FIG. 7 is a top view thereof; and,

FIG. 8 is a bottom thereof.

**1 Claim, 7 Drawing Sheets**

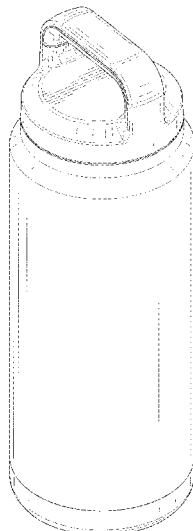

(56)

References Cited

U.S. PATENT DOCUMENTS

D332,379 S 1/1993 Murphy  
 D354,915 S 1/1995 Schneider et al.  
 D368,224 S 3/1996 Arndt  
 D396,191 S 7/1998 Kuzma et al.  
 D398,193 S 9/1998 Sanchez  
 D405,650 S 2/1999 Meier  
 D415,395 S 10/1999 Hunt et al.  
 D417,127 S 11/1999 Steadward et al.  
 D422,916 S 4/2000 Herrmann  
 6,332,557 B1 12/2001 Moran  
 D456,669 S 5/2002 Munari  
 D458,133 S 6/2002 Berish et al.  
 D458,134 S 6/2002 Berish et al.  
 D466,814 S 12/2002 Hurlburt  
 D479,800 S 9/2003 McRae  
 D482,607 S 11/2003 McRae  
 D494,425 S 8/2004 Segura  
 D524,909 S 7/2006 Bakke et al.  
 D525,518 S 7/2006 Baldwin  
 D533,032 S 12/2006 Liu et al.  
 D535,151 S 1/2007 Seum et al.  
 D536,929 S \* 2/2007 Kingsley ..... D7/510  
 D548,082 S \* 8/2007 Kingsley ..... D9/500  
 D553,914 S 10/2007 Wahl  
 D554,000 S 10/2007 Walsh  
 D564,363 S 3/2008 Rhea  
 D572,585 S 7/2008 Perrin et al.  
 D584,623 S 1/2009 Chupak  
 D586,184 S 2/2009 Miller et al.  
 D587,533 S 3/2009 Carreno  
 D592,909 S 5/2009 Alviar et al.  
 D596,460 S 7/2009 Nezu  
 D601,436 S 10/2009 Stephens et al.  
 D603,331 S 11/2009 Schupp  
 D603,722 S 11/2009 Reimer  
 D604,181 S 11/2009 Reimer  
 D604,561 S 11/2009 Chisholm  
 D605,040 S 12/2009 Fry et al.  
 D605,060 S 12/2009 Reimer  
 D611,346 S 3/2010 Camomile  
 D612,235 S 3/2010 Cresswell et al.  
 D614,918 S 5/2010 Chisholm  
 D615,360 S 5/2010 Joy et al.  
 D615,816 S 5/2010 Joy et al.  
 D616,703 S 6/2010 Joy et al.  
 D616,743 S 6/2010 Cresswell et al.  
 D616,744 S 6/2010 Cresswell et al.  
 D619,457 S 7/2010 Walsh  
 D619,458 S 7/2010 Walsh  
 D619,459 S 7/2010 Walsh  
 D620,798 S 8/2010 Cresswell et al.  
 D621,257 S 8/2010 Gullickson et al.  
 D621,258 S 8/2010 Gullickson et al.  
 D622,089 S 8/2010 Daniel et al.  
 D622,145 S 8/2010 Walsh  
 D623,475 S 9/2010 Aarnoudse et al.  
 D623,896 S 9/2010 Wahl et al.  
 D625,560 S \* 10/2010 Olson ..... D7/300.1  
 D625,563 S 10/2010 He  
 D625,564 S 10/2010 He  
 D625,616 S 10/2010 Gogola et al.  
 D626,414 S 11/2010 Cresswell et al.  
 D626,416 S \* 11/2010 Cresswell ..... D7/510  
 D627,601 S 11/2010 Eyal  
 D627,602 S 11/2010 Eyal  
 D627,604 S 11/2010 Eyal  
 D628,486 S 12/2010 Lane  
 D629,689 S 12/2010 Cresswell et al.  
 D629,690 S 12/2010 Cresswell et al.  
 D629,691 S 12/2010 Cresswell et al.  
 D630,474 S 1/2011 Gilbert  
 D630,475 S 1/2011 Lu  
 D631,666 S 2/2011 Lim et al.  
 D633,338 S 3/2011 Rosbach et al.  
 D633,794 S 3/2011 Cresswell et al.

D633,795 S 3/2011 Cresswell et al.  
 D633,796 S 3/2011 Cresswell et al.  
 D633,797 S 3/2011 Cresswell et al.  
 D635,457 S \* 4/2011 Lane ..... D7/511  
 D635,856 S 4/2011 Lauret  
 D638,695 S 5/2011 Woodrow et al.  
 D638,708 S 5/2011 Walsh  
 D639,164 S 6/2011 Walsh  
 D639,166 S 6/2011 Carreno  
 D639,661 S 6/2011 Llerena  
 D639,663 S 6/2011 Llerena  
 D641,591 S 7/2011 Tsukida  
 D651,847 S 1/2012 Gilbert  
 D652,255 S 1/2012 Carland  
 D652,682 S 1/2012 Eyal  
 D654,762 S 2/2012 Gilbert  
 D655,134 S 3/2012 Gilbert  
 D655,581 S 3/2012 Kotani  
 D657,196 S \* 4/2012 Beyers, III ..... D7/513  
 D658,064 S 4/2012 Barnes et al.  
 D658,445 S 5/2012 Carreno  
 D659,007 S 5/2012 Pape  
 D660,084 S 5/2012 Gilbert  
 D662,360 S \* 6/2012 George ..... D7/510  
 8,215,511 B1 7/2012 Lin  
 D664,809 S 8/2012 Eyal  
 D665,621 S 8/2012 Eyal  
 D668,913 S \* 10/2012 Mayer ..... D7/510  
 D670,137 S 11/2012 Gilbert  
 D672,238 S 12/2012 Aziz et al.  
 D672,609 S 12/2012 Aziz et al.  
 D675,100 S 1/2013 Herbst  
 D676,764 S 2/2013 Moore et al.  
 D678,772 S 3/2013 Johnson et al.  
 D680,389 S 4/2013 Zemel et al.  
 D684,059 S 6/2013 Johnson et al.  
 D686,078 S 7/2013 Johnson et al.  
 D688,093 S 8/2013 Roth et al.  
 D693,698 S 11/2013 Miller, Jr.  
 D695,138 S 12/2013 Ball  
 D696,945 S 1/2014 Newman  
 D697,404 S 1/2014 Johnson et al.  
 D698,668 S 2/2014 Vaughn  
 D701,464 S 3/2014 Ogata et al.  
 D702,092 S \* 4/2014 Mettler ..... D7/608  
 D702,506 S 4/2014 Mettler et al.  
 D708,954 S \* 7/2014 Barnes ..... D7/511  
 D709,734 S 7/2014 Kotani  
 D712,254 S 9/2014 Geis et al.  
 D712,255 S 9/2014 Geis et al.  
 D713,268 S 9/2014 Jones et al.  
 D713,365 S 9/2014 Green  
 D717,102 S 11/2014 Taketani et al.  
 D724,385 S \* 3/2015 Hurley ..... D7/511  
 D728,315 S 5/2015 Bo  
 D728,995 S 5/2015 Barberi  
 D729,579 S \* 5/2015 Molayem ..... D7/507  
 D729,584 S 5/2015 Weston et al.  
 D732,402 S 6/2015 Jones et al.  
 D734,154 S 7/2015 Johnson et al.  
 D735,578 S 8/2015 Mazurkiewicz et al.  
 D741,655 S 10/2015 Whelan et al.  
 D743,742 S 11/2015 Rummel et al.  
 D744,781 S 12/2015 Rummel et al.  
 D754,472 S 4/2016 Munari  
 D799,898 S 10/2017 Yao  
 D803,005 S 11/2017 Lane  
 D808,731 S 1/2018 Boroski et al.  
 D808,732 S 1/2018 Boroski  
 2011/0186585 A1 \* 8/2011 Lu ..... A47J 41/00  
 220/575  
 2014/0353275 A1 \* 12/2014 Hung ..... B65D 47/305  
 215/311

FOREIGN PATENT DOCUMENTS

CN 303528321 12/2015  
 CN 303905254 11/2016  
 DE 29707837 U1 7/1997

(56)

## References Cited

## FOREIGN PATENT DOCUMENTS

EP	2567909	A1	3/2013
JP	2014210613	A	11/2014
JP	1530358		8/2015
KR	300303813.0000		8/2002
KR	300751936.0000		7/2014
KR	300764889.0000		10/2014
WO	D088688-002		1/2016

## OTHER PUBLICATIONS

United States District Court Western District of Texas Austin Division, “Complaint,” *YETI Coolers, LLC v. Costco Wholesale Corporation*, Case: 1:17-cv-07025, Document #1, filed Sep. 28, 2017, 99 pages.

United States District Court Western District of Texas Austin Division, “Complaint,” *YETI Coolers, LLC v. Alibaba Group Holding Limited, Alibaba (China) Technology Co., Ltd., Alibaba.com Hong Kong Limited, Alibaba.com Singapore E-Commerce Private Limited, Hangzhou Alibaba Advertising Co. Ltd., and Huizhou Dashu Trading Co., Ltd.*, Case: 1:17-cv-00936, Document #1, filed Sep. 28, 2017, 272 pages.

United States District Court Western District of Texas Austin Division, “Complaint,” *YETI Coolers, LLC v. ContextLogic, Inc. d/b/a Wish.com*, Case: 1:17-cv-00937, Document #1, filed Sep. 28, 2017, 238 pages.

United States District Court Western District of Texas Austin Division, “Complaint,” *YETI Coolers, LLC v. Dunhuang Group, SZ Flowerfairy Technology Co., Ltd., Tan Er Pa Technology Co., Ltd., Shenzhen Great Electronic Technology Co., Ltd., and Huagong Trading Co., Ltd.*, Case: 1:17-cv-00938, Document #1, filed Sep. 28, 2017, 272 pages.

United States International Trade Commission of Washington, DC, “Complaint Under Section 337 of the Tariff Act of 1930, as Amended,” *YETI Coolers, LLC vs. Alibaba (China) Technology Co., Ltd., Alibaba Group Holding Limited, Alibaba.com Hong Kong Limited, Alibaba.com Singapore E-Commerce Private Limited, Bonanza.com, Inc., ContextLogic, Inc. d/b/a Wish, Dunhuang Group, Hangzhou Alibaba Advertising Co. Ltd., Huizhou Dashu Trading Co., Ltd., Huagong Trading Co., and Tan Er Pa Technology Co., Ltd.*, Case: 337-TA-3261, filed Sep. 28, 2017, 191 pages.

“64 oz Double-Wall Vacuum-Insulated Growler” published on Nov. 14, 2014, retrieved from [https://web.archive.org/web/\\*/http://www.fiftyfiftybottles.com/64oz-growler/](https://web.archive.org/web/*/http://www.fiftyfiftybottles.com/64oz-growler/) on Sep. 22, 2016.

“Hydro Flask Insulated Stainless Steel Water Bottle” published on Dec. 29, 2014, retrieved from [http://web.archive.org/web/\\*/https://www.amazon.com/dp/B004X55L9U/ref=twister\\_B00GA03LG4?\\_encoding=UTF8&psc=1](http://web.archive.org/web/*/https://www.amazon.com/dp/B004X55L9U/ref=twister_B00GA03LG4?_encoding=UTF8&psc=1) on Sep. 22, 2016.

“Eco Vessel 64 ounce Growler” published on Jan. 28, 2015, retrieved from [http://web.archive.org/web/\\*/http://www.snewsnet.com/press-release/eco-vessel-launches-the-boss-insulated-growler/](http://web.archive.org/web/*/http://www.snewsnet.com/press-release/eco-vessel-launches-the-boss-insulated-growler/) on Sep. 22, 2016.

“Classic Vacuum Bottle—1.1 qt.” published on Feb. 22, 2015, retrieved from [http://www.amazon.com/Stanley-Classic-Vacuum-Bottle-1-1qt/dp/images/B004E7NY3U/ref=dp\\_image\\_1\\_0?ie=UTF8&s=sporing-goods&img=color\\_name=1](http://www.amazon.com/Stanley-Classic-Vacuum-Bottle-1-1qt/dp/images/B004E7NY3U/ref=dp_image_1_0?ie=UTF8&s=sporing-goods&img=color_name=1).

“UA Beyond 18 oz. Vacuum Insulated Water Bottle” published on Mar. 29, 2015, retrieved from [http://web.archive.org/web/\\*/https://www.underarmour.com/en-us/beyond-18-oz-vacuum-insulated-ss-bottle-with-flip-top-lid/pid1232014](http://web.archive.org/web/*/https://www.underarmour.com/en-us/beyond-18-oz-vacuum-insulated-ss-bottle-with-flip-top-lid/pid1232014) on Sep. 22, 2016.

“KB8 20 oz. Double Wall Stainless Bottle,” published on May 22, 2015, retrieved from <https://web.archive.org/web/20150807054814/http://thermo-steel.com/work/keen-kb8> on Sep. 27, 2016.

“2015 Boulder Insulated Water Bottle with Tea, Fruit, Ice Strainer” published on Jun. 28, 2015, retrieved from [http://web.archive.org/web/\\*/http://www.ecovessel.com/boulder-insulated-water-bottle-with-tea-fruit-ice-strainer-20-oz/](http://web.archive.org/web/*/http://www.ecovessel.com/boulder-insulated-water-bottle-with-tea-fruit-ice-strainer-20-oz/) on Sep. 22.

“Klean Kanteen Insulated Classic with Polypropylene” published on Jul. 7, 2015, retrieved from [http://web.archive.org/web/\\*/https://](http://web.archive.org/web/*/https://)

[www.lifewithoutplastic.com/store/klean-kanteen-insulated-classic-with-polypropylene-loop-cap-0-95-1-32-oz.html](http://www.lifewithoutplastic.com/store/klean-kanteen-insulated-classic-with-polypropylene-loop-cap-0-95-1-32-oz.html) on Sep. 22, 2016. KOLD Vacuum Insulated Stainless Steel Sports Bottle: Announced Dec. 8, 2015 [online], site visited [May 11, 2016]. Available from Internet URL: <http://www.amazon.com/KOLD-Sports-Water-Bottles-Insulated/dp/B018YH K79E/ref=cm>.

YETI 36 oz. Rambler: Announced Jan. 11, 2016 [online], site visited [May 10, 2016]. Available from Internet URL: <http://yeticoolers.com/rambler-bottle-36-oz/>.

United States District Court Western District of Texas Austin Division, “Complaint for Damages and Injunctive Relief,” *YETI Coolers, LLC v. RTIC Coolers, LLC, RTIC Drinkware, LLC and RTIC Web Services, LLC*, Case: 1:16-cv-00985, Document #1, filed Aug. 18, 2016, 27 pages.

English translation of Office Action dated Sep. 6, 2016 for JP Application No. 2016-9603, 4 pages.

English translation of Office Action dated Sep. 6, 2016 for JP Application No. 2016-9604, 3 pages.

United States District Court Western District of Texas Austin Division, “Defendants’ Motion to Dismiss Pursuant to Rule 12(b)(6),” *YETI Coolers, LLC v. RTIC Coolers, LLC, RTIC Drinkware, LLC and RTIC Web Services, LLC*, Case: 1:16-cv-00985, Document 9, filed Sep. 23, 2016, 27 pages.

English translation of Office Action dated Oct. 4, 2016 for JP Application No. 2016-9607, 2 pages.

English translation of Office Action dated Oct. 4, 2016 for JP Application No. 2016-9608, 2 pages.

United States District Court Western District of Texas Austin Division, “Plaintiffs’ First Amended Complaint,” *YETI coolers, LLC v. RTIC Coolers, LLC, RTIC Drinkware, LLC, and RTIC Web Services, LLC*, Case 1:16-cv-00985-RP, Document 15, filed Oct. 14, 2016, 26 pages.

United States District Court Western District of Texas Austin Division, “Defendants’ Notice of Responsive Pleading to Plaintiff’s First Amended Complaint,” *YETI Coolers, LLC v. RTIC Coolers, LLC, RTIC Drinkware, LLC, and RTIC Web Services, LLC*, Case 1:16-cv-00985-RP, Document 23, filed Oct. 26, 2016, 4 pages.

English translation of Office Action dated Nov. 1, 2016 for JP Application No. 2016-9605, 2 pages.

English translation of Office Action dated Nov. 1, 2016 for JP Application No. 2016-9606, 2 pages.

United States District Court Western District of Texas Austin Division, “Plaintiff Yeti Coolers, LLC’s Original complaint,” *YETI Coolers, LLC v. Ontel Products Corporation and World Pack USA, LLC*, Case: 1:17-cv-00091-RP, Document #1, filed Feb. 8, 2017, 65 pages.

United States District Court Western District of Texas Austin Division, “Defendants’ Answers and Defenses to Plaintiff’s Original Complaint,” *YETI Coolers, LLC v. Ontel Products Corporation and World Pack USA, LLC*, Case: 1:17-v-00091-RP, Document #14, filed Mar. 21, 2017, 45 pages.

English Translation of Office Action dated Apr. 4, 2017 for JP Application No. 2016-9605, 11 pages.

English Translation of Office Action dated Apr. 4, 2017 for JP Application No. 2016-9606, 10 pages.

United States District Court Western District of Texas Austin Division, “Plaintiffs’ Complaint for Damages and Injunctive Relief,” *YETI Coolers, LLC v. Houssam Rabi d/b/a Hoo-Sizzy*, Case 1:17-cv-00418, Document 1, filed May 5, 2017, 37 pages.

United States District Court Western District of Texas Austin Division, “Plaintiffs’ Complaint for Damages and Injunctive Relief,” *YETI Coolers, LLC v. Seth Stevens d/b/a SDS Marketing d/b/a Eskimo Coolers, Panther Group LLC d/b/a Eskimo Coolers, Panther Group Sales, LLC d/b/a Eskimo Coolers, and Silver Fox Sales, LLC*, Case 1:17-cv-00423, Document 1, filed May 5, 2017, 77 pages.

United States District Court Western District of Texas Austin Division, “Complaint,” *YETI Coolers, LLC v. SF Associates, Inc.*, Case: 1:17-cv-01070, Document #1, filed Nov. 10, 2017, 39 pages.

(56)

**References Cited**

OTHER PUBLICATIONS

United States International Trade Commission Washington, DC, Respondents Alibaba, Dunhuang Group, and Bonanza.com's "Notice of Prior Art", Inv. No. 33-TA-1084 dated Feb. 9, 2018, 8 pages.

\* cited by examiner

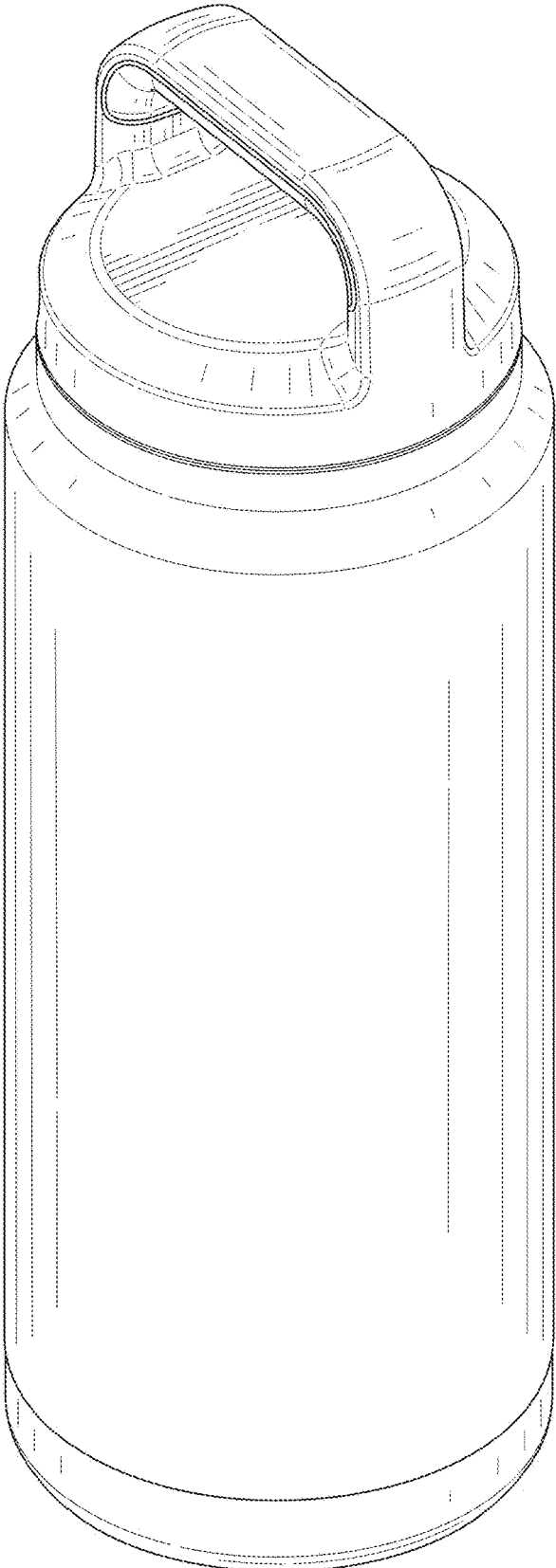

FIG. 1

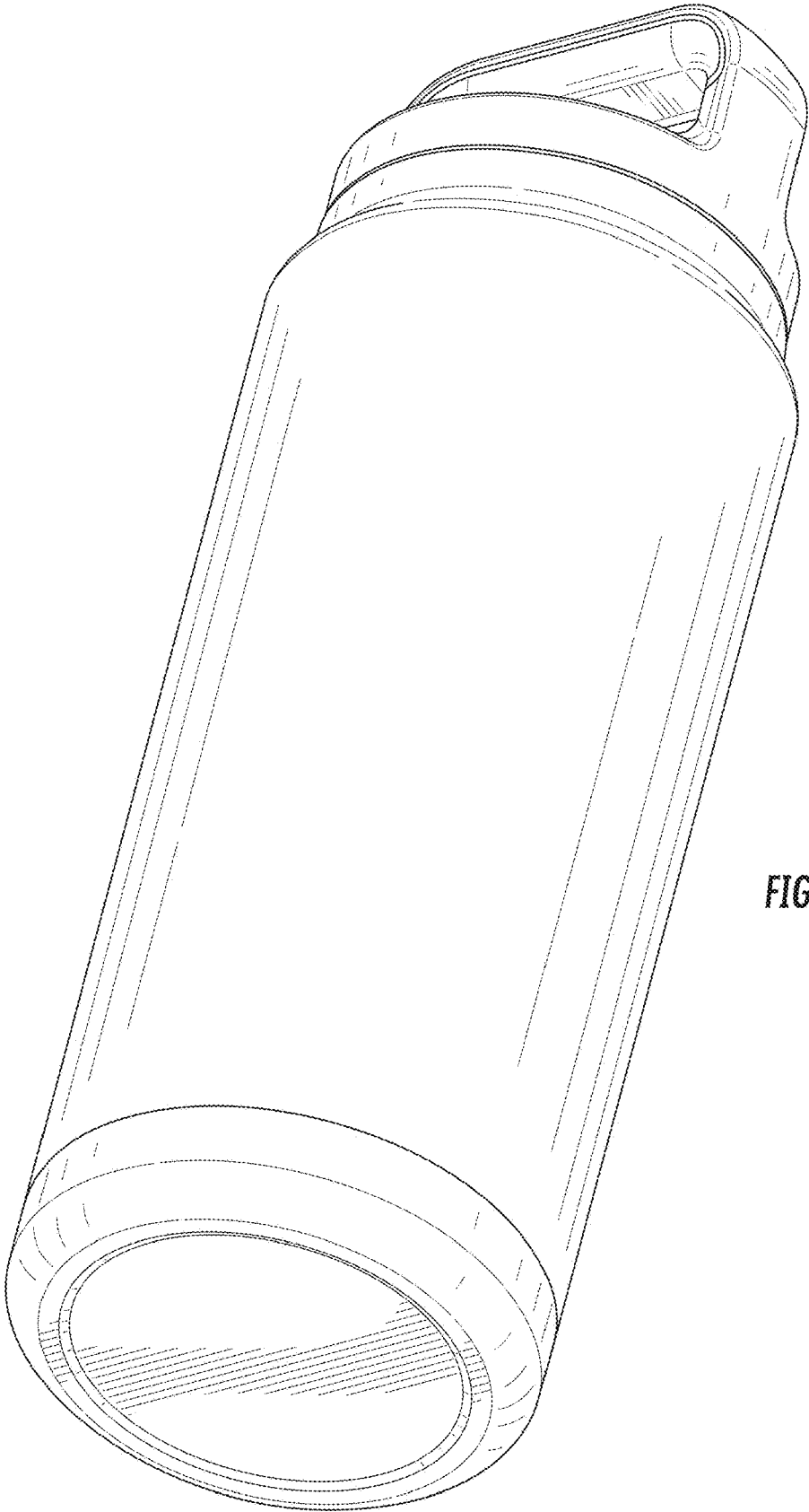

FIG. 2

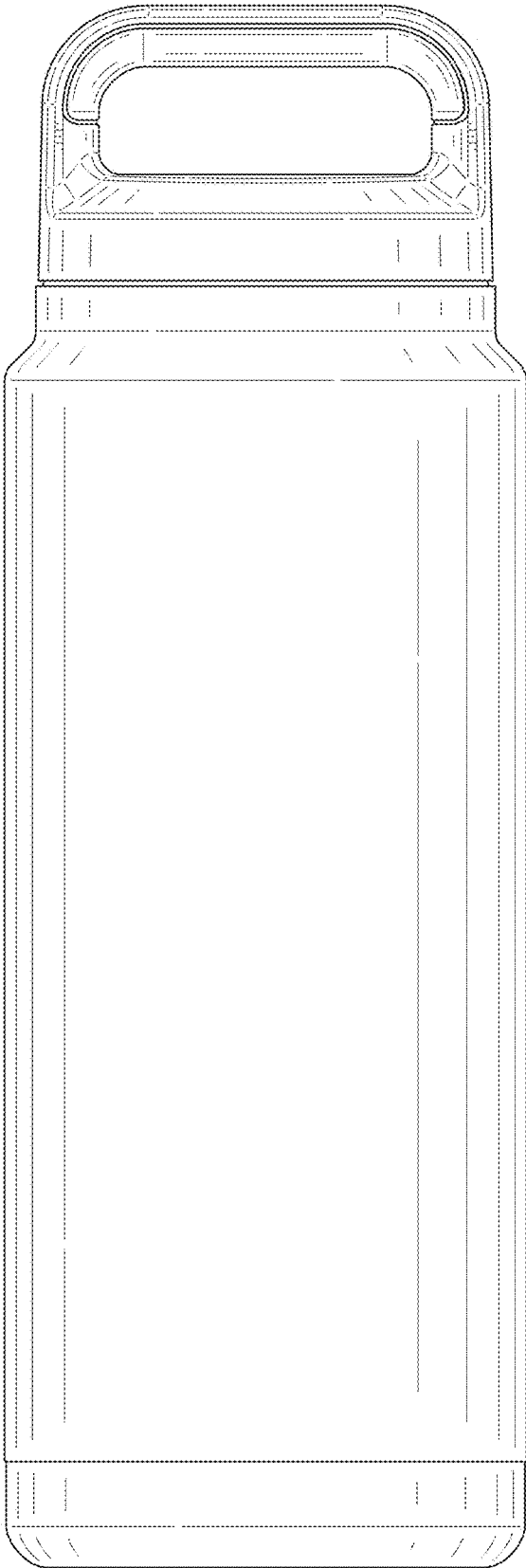

FIG. 3

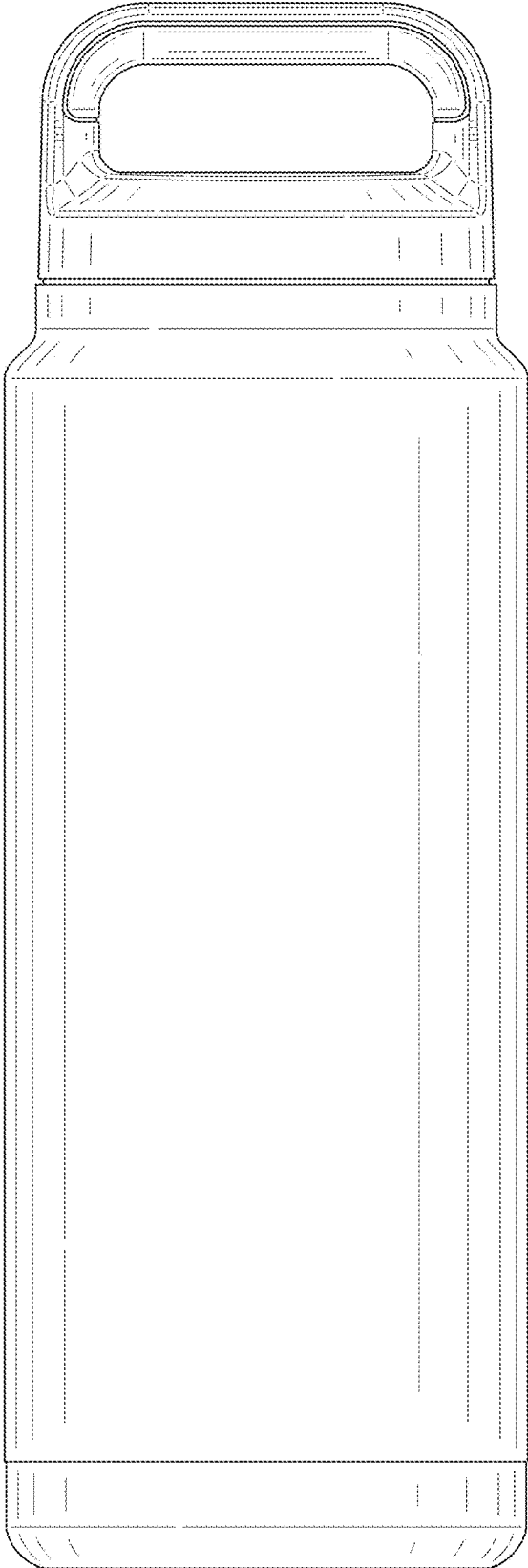

FIG. 4



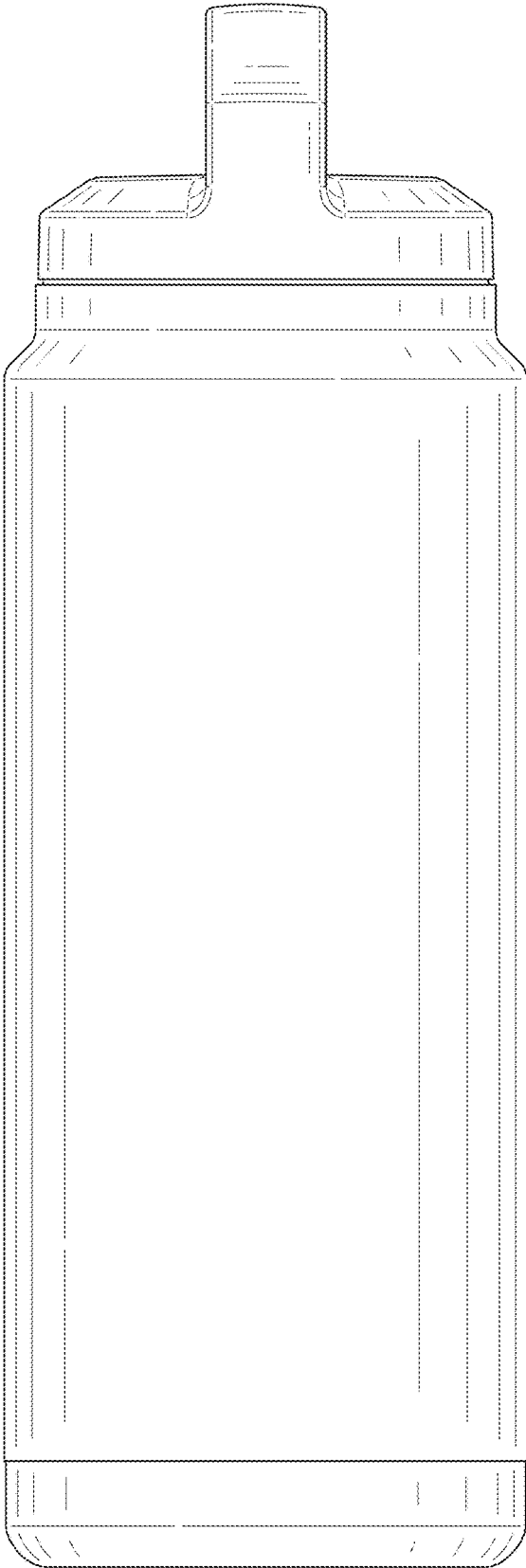

FIG. 5

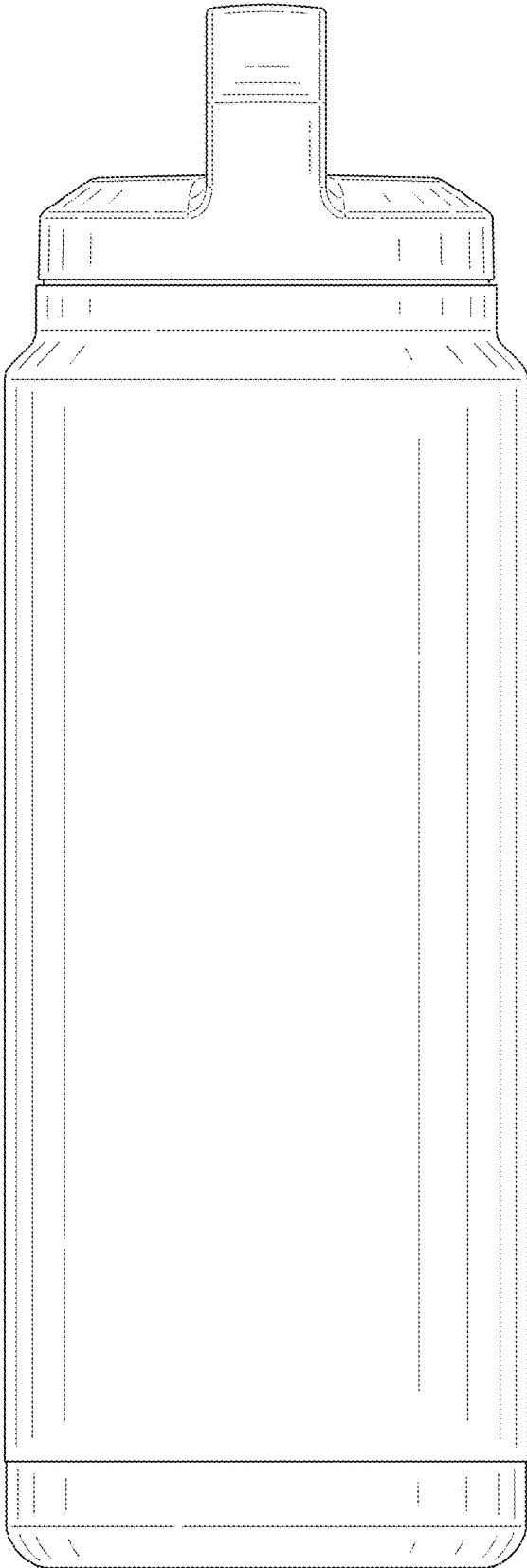

FIG. 6

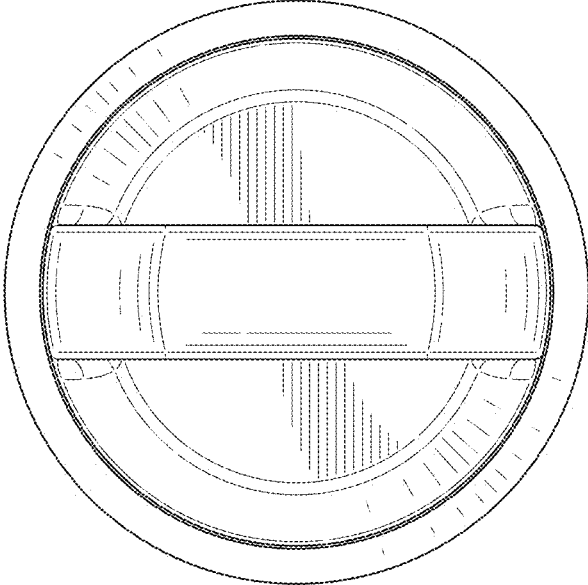

FIG. 7

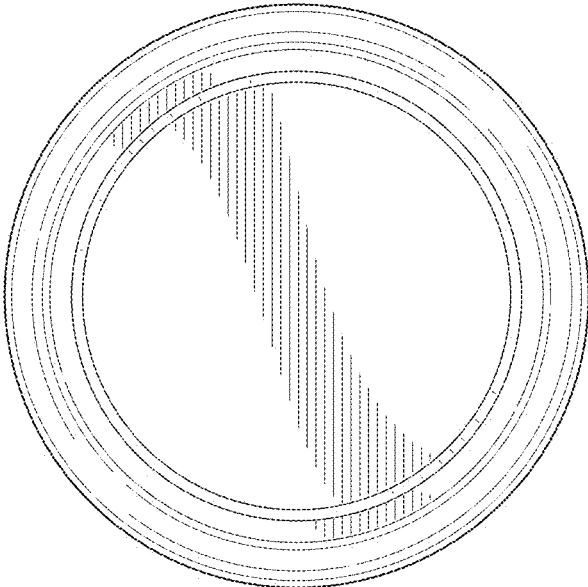

FIG. 8