



US00D585489S

(12) **United States Design Patent**
Han

(10) **Patent No.:** **US D585,489 S**

(45) **Date of Patent:** **** Jan. 27, 2009**

(54) **MARKER**

(76) Inventor: **Bongkeun Han**, c/o Shinhan Art Materials, Inc. 122-847 Shinhan Bldg., 16-24 Bulkwang-Dong, Eunpyung-Gu, Seoul (KR)

(**) Term: **14 Years**

(21) Appl. No.: **29/291,908**

(22) Filed: **Sep. 20, 2007**

(51) **LOC (9) Cl.** **19-06**

(52) **U.S. Cl.** **D19/36**

(58) **Field of Classification Search** D19/35, D19/36, 41-51, 53-57; 24/11 F, 11 P, 11 R; 401/52, 99, 100, 104-109, 192, 195, 196
See application file for complete search history.

(56) **References Cited**

U.S. PATENT DOCUMENTS

D83,668 S *	3/1931	De Sherbinin	D99/35
3,077,184 A *	2/1963	Vogel	401/34
D279,992 S *	8/1985	Gribb	D19/43
D306,316 S *	2/1990	Shintani	D19/36
D313,623 S *	1/1991	Yazaki	D19/48
D329,660 S *	9/1992	Yamanaka	D19/48
D369,384 S *	4/1996	Yasoshima	D19/36
D399,253 S *	10/1998	Raymond	D19/36
6,179,501 B1 *	1/2001	Fulop	401/34
D451,137 S *	11/2001	Reichmann	D19/36
D470,885 S *	2/2003	Tahara	D19/36
D482,065 S *	11/2003	Hung	D19/36

D500,081 S * 12/2004 Hung D19/43
D502,506 S * 3/2005 Reichmann D19/43

* cited by examiner

Primary Examiner—Elizabeth A Albert
(74) *Attorney, Agent, or Firm*—Adams & Wilks

(57) **CLAIM**

The ornamental design for a marker, as shown and described.

DESCRIPTION

FIG. 1 is a top and front perspective view of a marker showing my new design;

FIG. 2 is a front elevational view thereof, the rear, top and bottom all being the same in appearance as the front;

FIG. 3 is a left side elevational view thereof, the right side being the same in appearance as the left side;

FIG. 4 is a top and front perspective view of the marker in a state in which the cap members are removed;

FIG. 5 is a front elevational view of the marker in a state in which the cap members are removed;

FIG. 6 is a top view of the marker shown in FIG. 5;

FIG. 7 is a rear elevational view of the marker shown in FIG. 5;

FIG. 8 is a left side elevational view of the marker shown in FIG. 5; and,

FIG. 9 is a right side elevational view of the marker shown in FIG. 5.

1 Claim, 5 Drawing Sheets

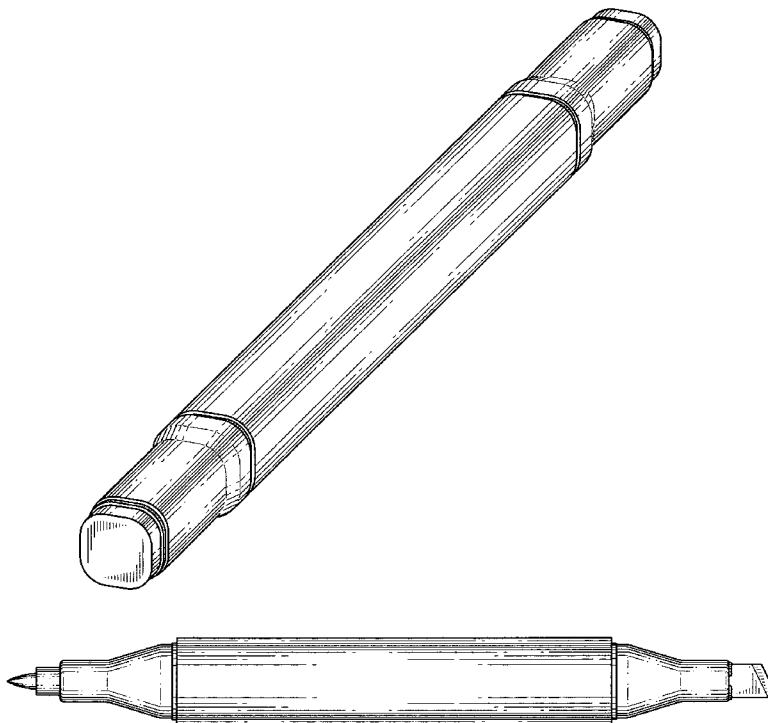

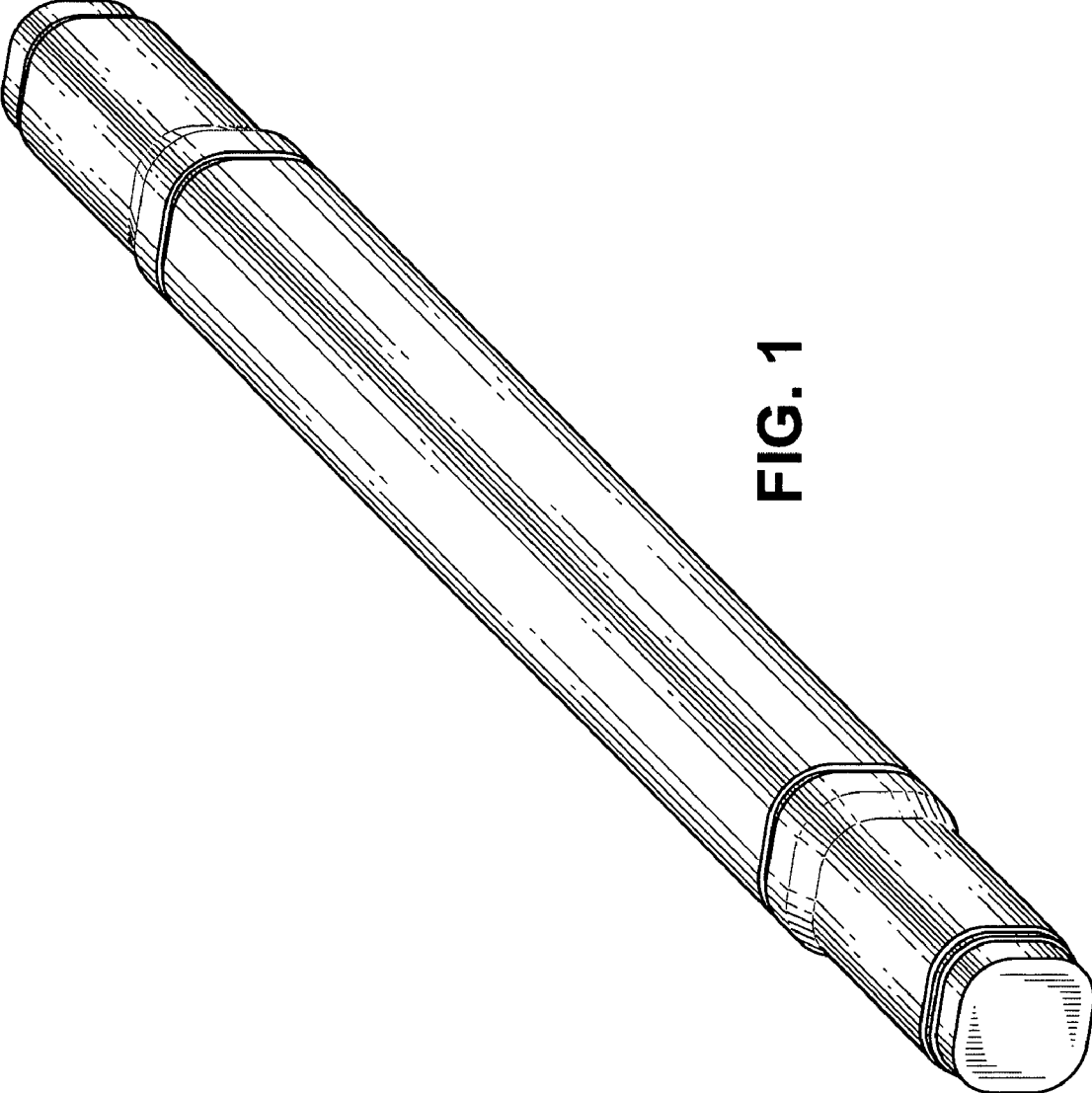

FIG. 1

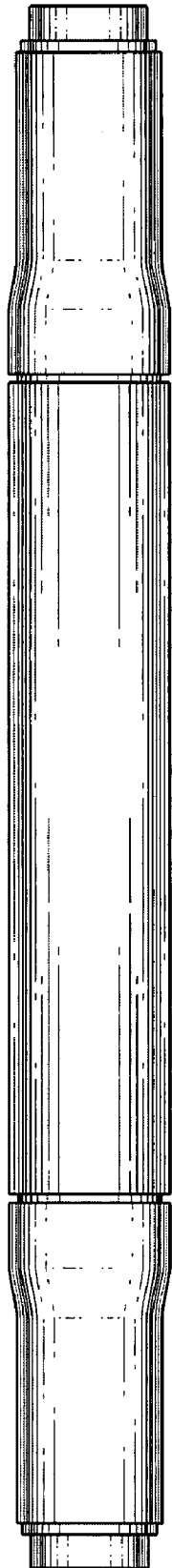

FIG. 2

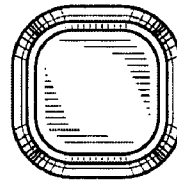

FIG. 3

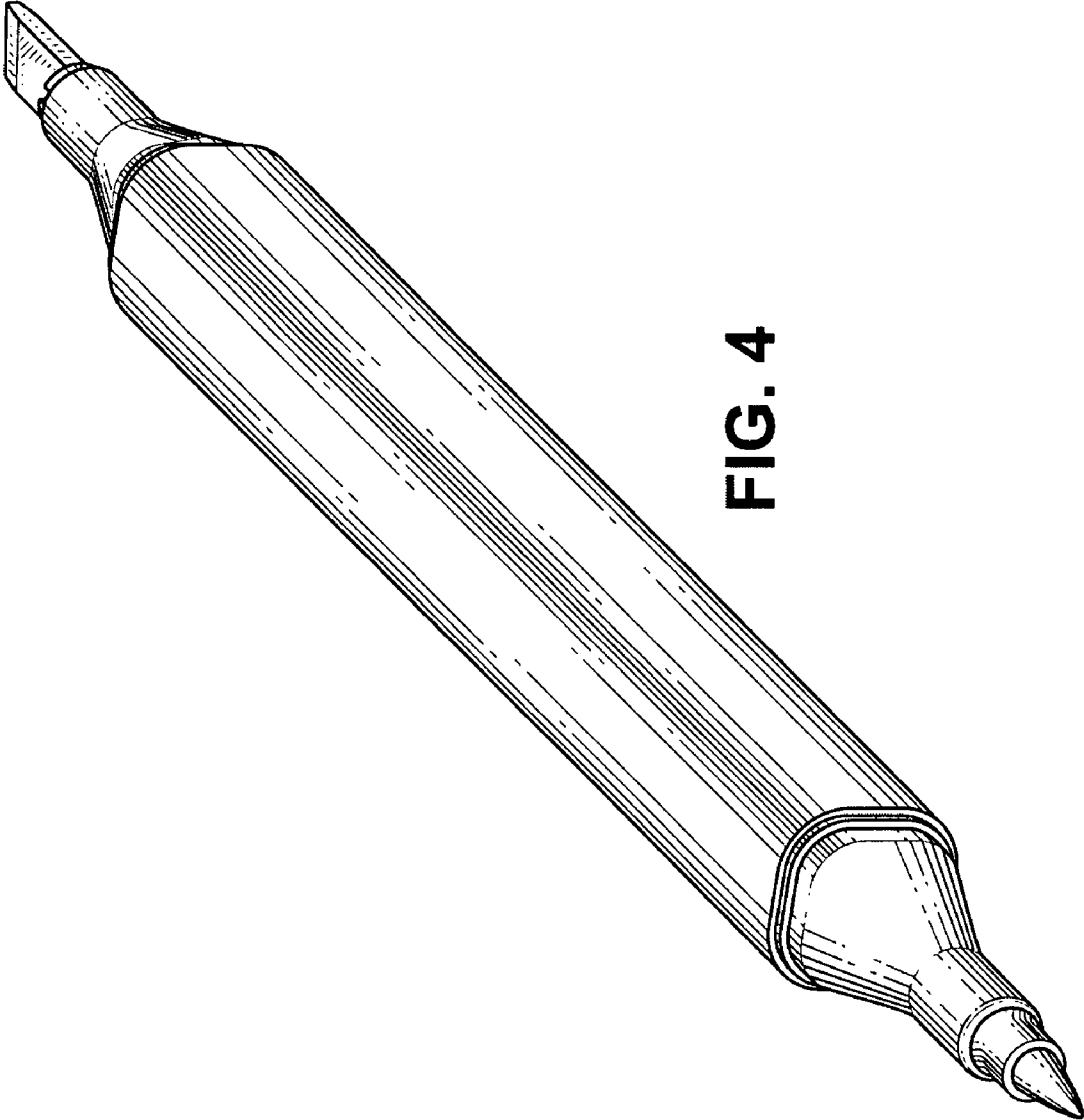

FIG. 4

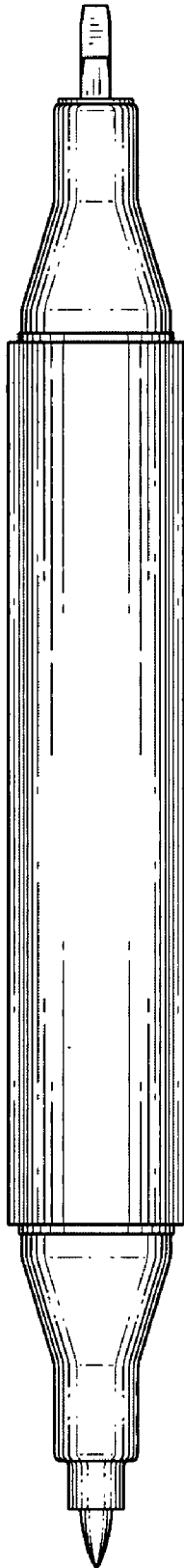

FIG. 5



FIG. 6



FIG. 7

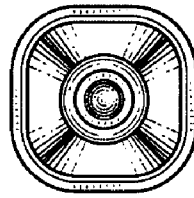

FIG. 8

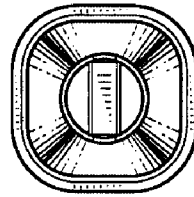

FIG. 9