



US00D761561S

(12) **United States Design Patent**  
**Cheng**

(10) **Patent No.:** **US D761,561 S**

(45) **Date of Patent:** **\*\* Jul. 19, 2016**

(54) **HANGBAG**

(71) Applicant: **Shu-Yen Cheng**, Taoyuan (TW)

(72) Inventor: **Shu-Yen Cheng**, Taoyuan (TW)

(\*\*) Term: **14 Years**

(21) Appl. No.: **29/516,568**

(22) Filed: **Feb. 4, 2015**

(51) **LOC (10) Cl.** ..... **03-01**

(52) **U.S. Cl.**  
USPC ..... **D3/246**

(58) **Field of Classification Search**

USPC ..... D3/304, 307, 232, 233, 240–243, 245,  
D3/246, 318, 276, 289, 900; 150/100,  
150/103–110, 113–114, 117–119  
CPC .. A45C 13/002; A45C 13/02; A45C 2200/10;  
A45C 3/08; A45C 3/06; A45C 3/04; A45C  
7/077; A21C 1/024

See application file for complete search history.

(56) **References Cited**

**U.S. PATENT DOCUMENTS**

526,566 A \* 9/1894 Field ..... B65D 33/12  
2/248  
2,164,641 A \* 7/1939 Davenport ..... A45C 7/0077  
383/127  
4,153,146 A \* 5/1979 Patton ..... A45C 7/0068  
190/103  
D280,043 S \* 8/1985 Allen ..... D3/303  
D463,118 S \* 9/2002 Tucker ..... D3/246

D491,354 S \* 6/2004 Chapelier ..... D3/246  
D535,820 S \* 1/2007 Kamiya ..... D3/246  
D596,396 S \* 7/2009 McCoy ..... D3/232  
D603,607 S \* 11/2009 Morelli ..... D3/245  
D711,094 S \* 8/2014 Simons ..... D3/232  
D732,899 S \* 6/2015 Seiders ..... D3/246  
2015/0201722 A1 \* 7/2015 Brouard ..... A45C 3/001  
150/107

\* cited by examiner

*Primary Examiner* — Derrick Holland

*Assistant Examiner* — Jennifer O King

(74) *Attorney, Agent, or Firm* — The Weintraub Group,  
P.L.C.

(57) **CLAIM**

The ornamental design for a hangbag, as shown and described.

**DESCRIPTION**

FIG. 1 is a perspective view of a hangbag showing my new design;

FIG. 2 is a front view thereof;

FIG. 3 is a rear view thereof;

FIG. 4 is a left side view thereof;

FIG. 5 is a right side view thereof;

FIG. 6 is a top view thereof;

FIG. 7 is a bottom view thereof; and,

FIG. 8 is an enlarged view of the annotated portion in FIG. 1. The broken lines shown represent unclaimed subject matter and form no part of the claimed design.

**1 Claim, 8 Drawing Sheets**

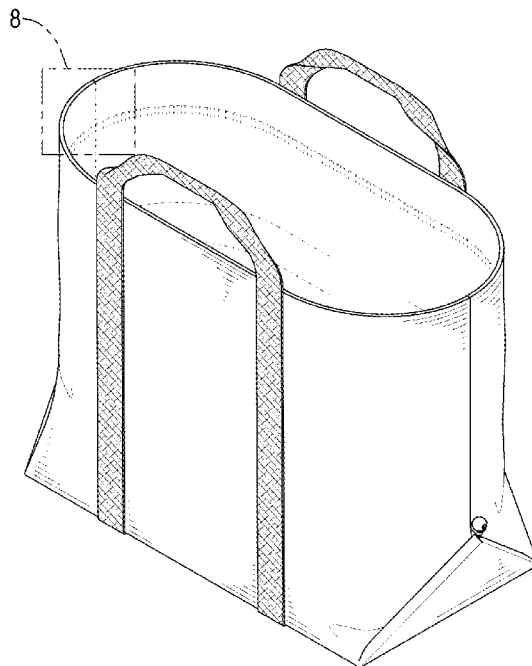

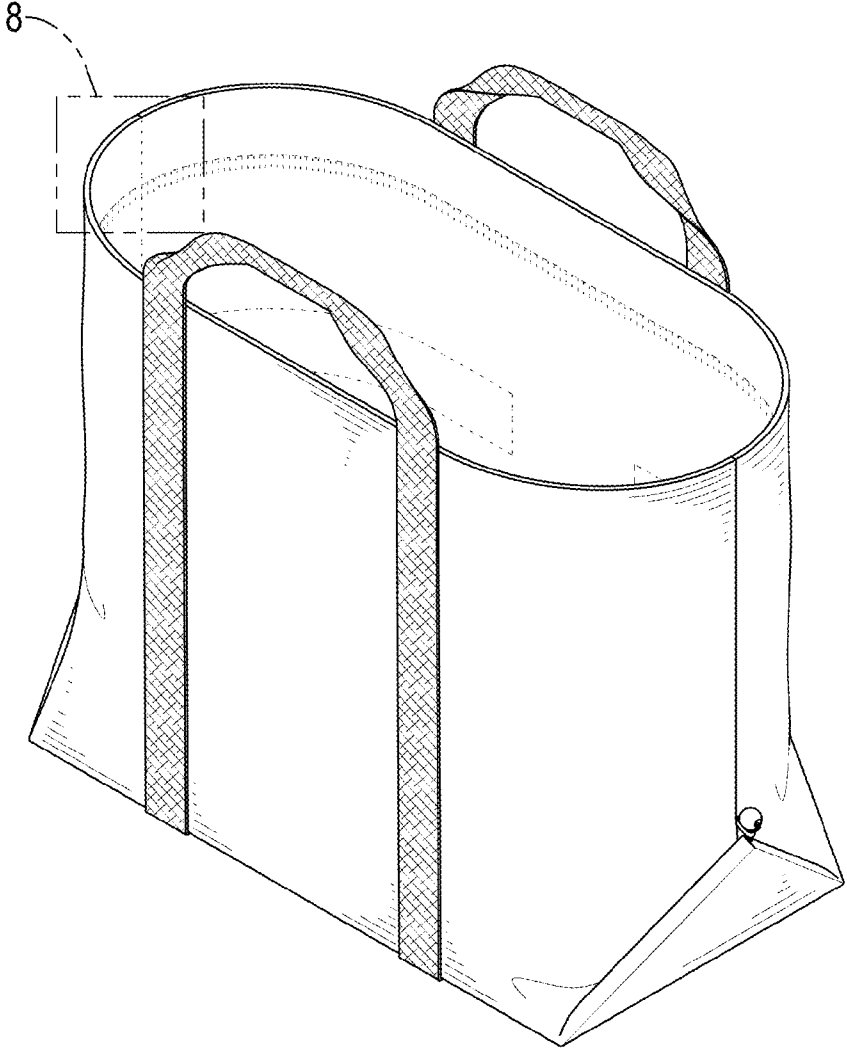

FIG.1

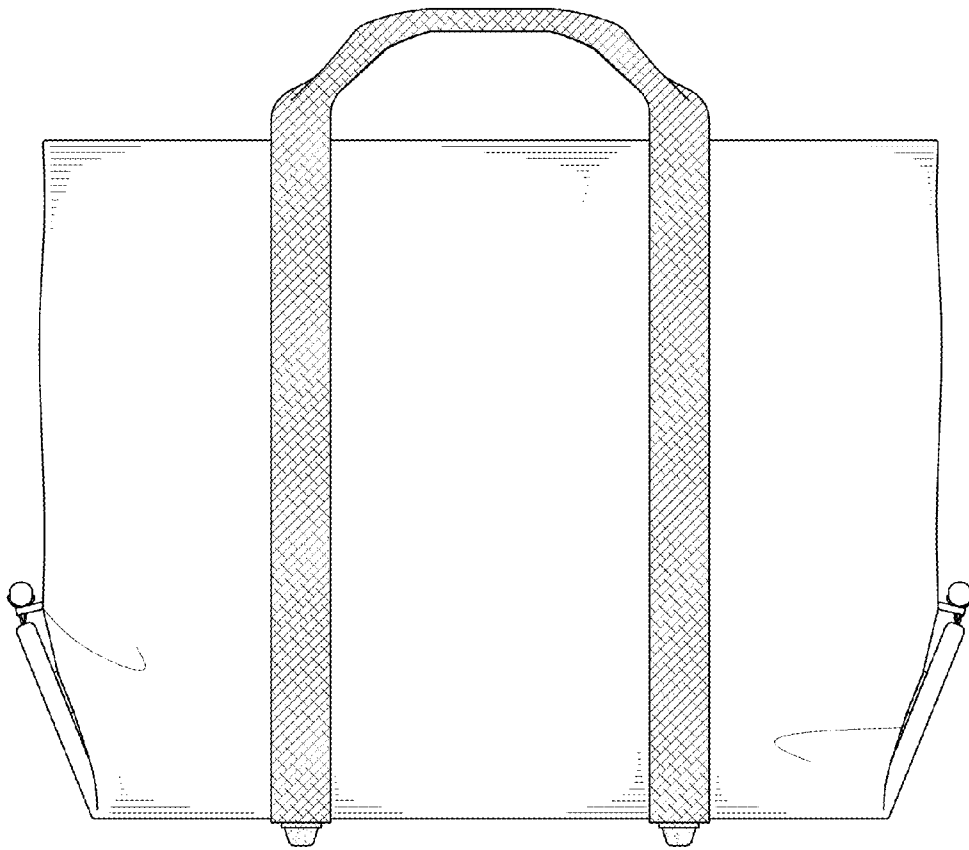

FIG.2

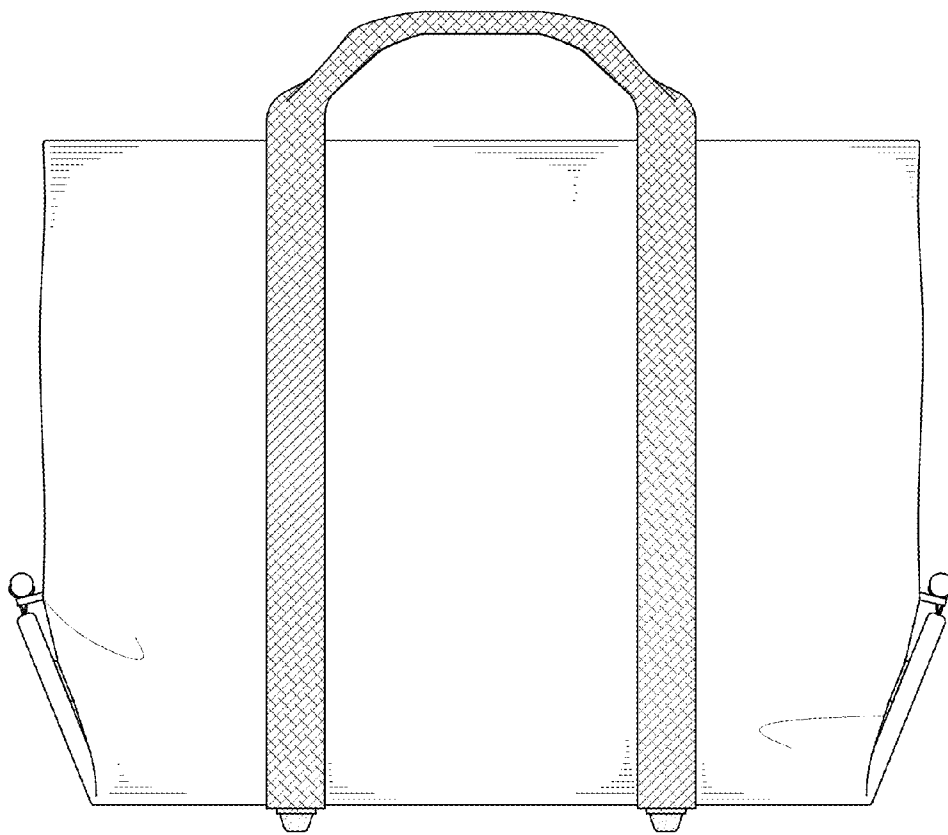

FIG.3

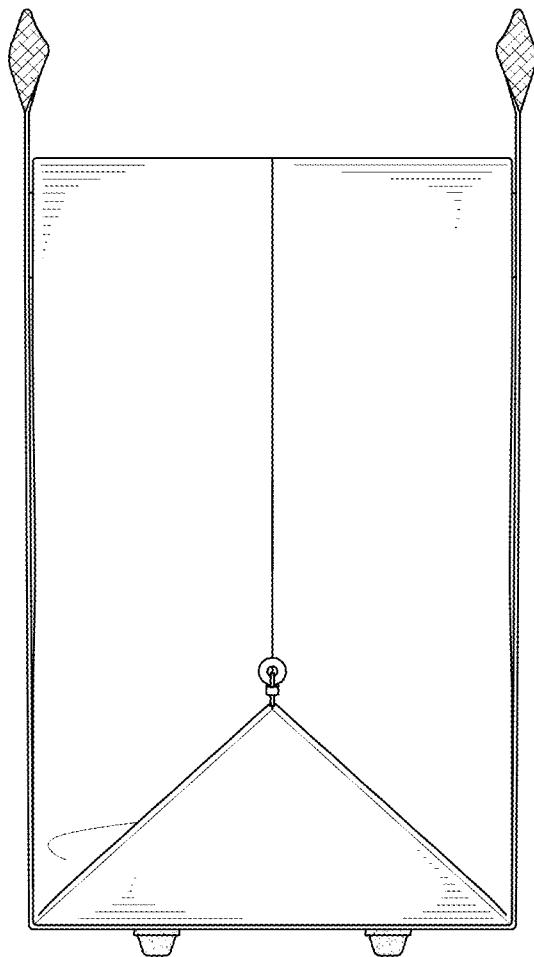

FIG.4

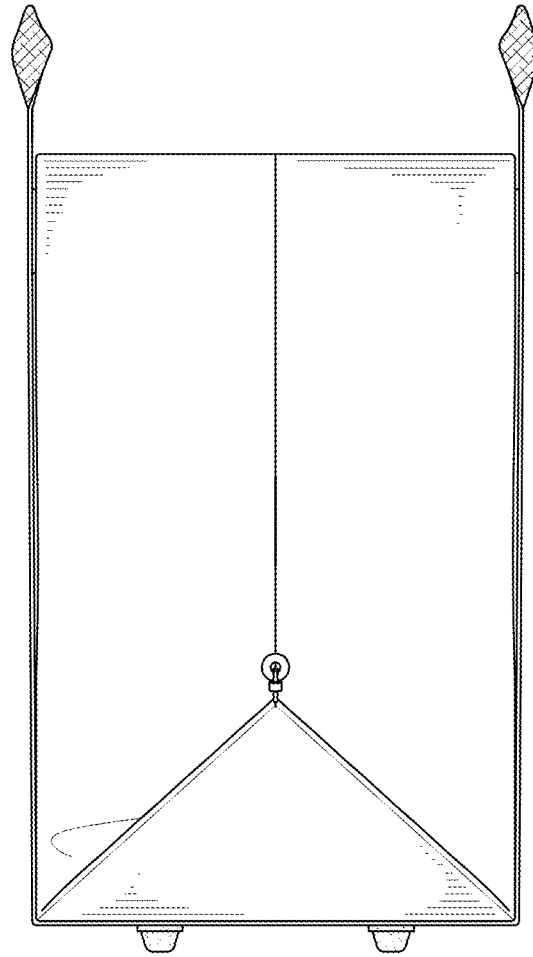

FIG.5

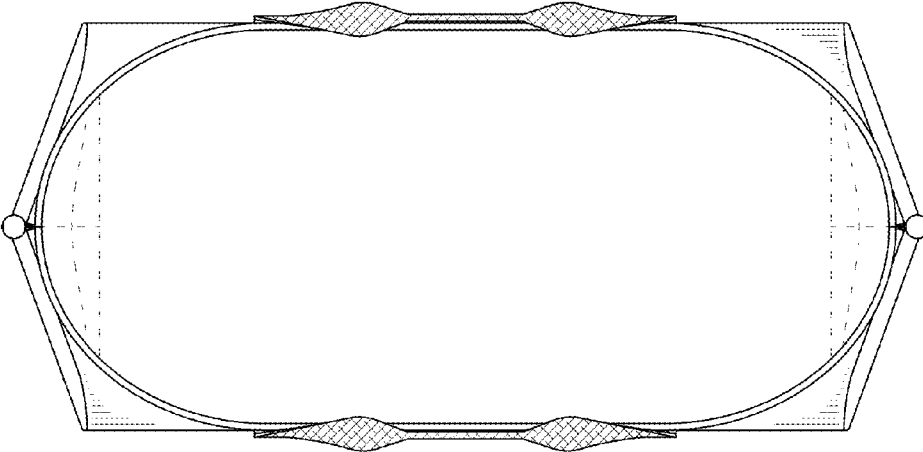

FIG.6

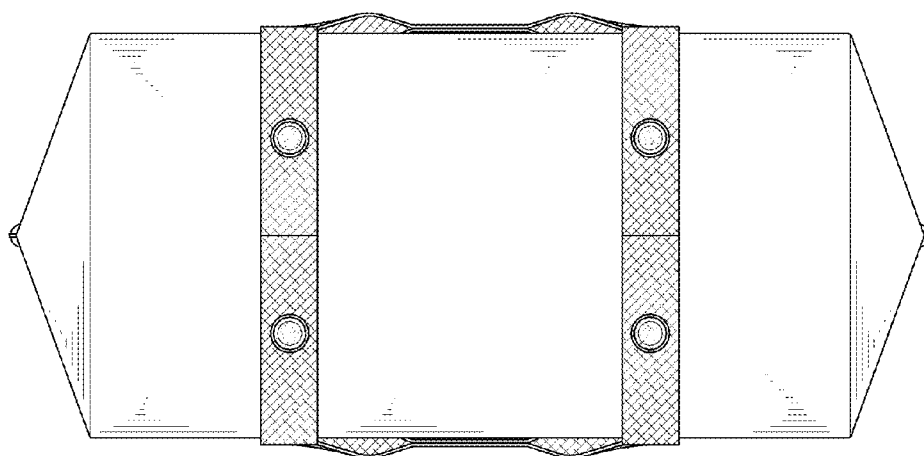

FIG.7



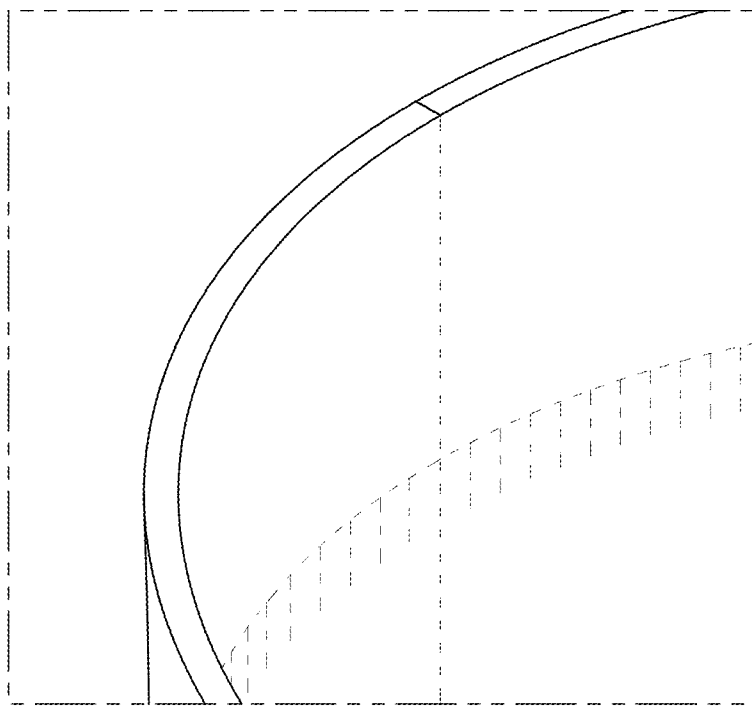

FIG.8