



US00D860975S

(12) **United States Design Patent**  
**Briggs et al.**

(10) **Patent No.:** **US D860,975 S**

(45) **Date of Patent:** **\*\* Sep. 24, 2019**

(54) **EARPHONE**

(71) Applicant: **New Audio LLC**, New York, NY (US)

(72) Inventors: **Drew Stone Briggs**, Brooklyn, NY (US); **Nicholas Slaney**, Jersey City, NJ (US); **Thomas C. Wilson**, Brooklyn, NY (US); **Marten Wallby**, Malmo (SE)

(73) Assignee: **New Audio LLC**, New York, NY (US)

(\*\*) Term: **15 Years**

(21) Appl. No.: **29/632,542**

(22) Filed: **Jan. 8, 2018**

(51) **LOC (12) Cl.** ..... **14-01**

(52) **U.S. Cl.**

USPC ..... **D14/223**

(58) **Field of Classification Search**

USPC ... D14/205, 217, 221, 223, 224, 224.1, 225;  
D24/173, 174

CPC ..... H04R 1/10; H04R 1/1016; H04R 1/1066;  
H04R 1/105; H04R 1/1033; H04R 1/08;  
H04R 5/033; H04R 5/0335; H04R 25/00

See application file for complete search history.

(56) **References Cited**

**U.S. PATENT DOCUMENTS**

D208,784 S *	10/1967	Sanzone .....	D24/174
D568,302 S *	5/2008	Oh .....	D14/223
D719,549 S *	12/2014	Henry .....	D14/223
D728,107 S *	4/2015	Torres Martin .....	D24/174
D745,862 S *	12/2015	Otani .....	D14/223
D755,158 S *	5/2016	Lee .....	D14/205
D801,950 S *	11/2017	Otani .....	D14/223
D813,205 S *	3/2018	Palmborg .....	D14/223
D817,309 S *	5/2018	Czaniecki .....	D14/223
D818,989 S *	5/2018	Silva .....	D14/205

D822,646 S *	7/2018	Dang .....	D14/223
D823,835 S *	7/2018	Loermann .....	D14/223
D824,371 S *	7/2018	Loermann .....	D14/223
2018/0221209 A1 *	8/2018	Ogut .....	A61F 11/08

**OTHER PUBLICATIONS**

True Wireless Earphones, posted © 2018 [online], retrieved Dec. 6, 2018, retrieved from internet, <<https://www.masterdynamic.com/products/mw07-true-wireless-earphones>>.\*

MW07\_SKU\_TS\_15, posted Sep. 11, 2018 0:04 [online], retrieved Dec. 6, 2018, retrieved from internet, <<https://www.youtube.com/watch?v=UKkBh3XIIQk&feature=youtu.be>>.\*

Master & Dynamic MW07 True Wireless Earphones, posted Sep. 19, 2018 [online], retrieved Dec. 6, 2018, retrieved from internet, <<https://www.amazon.com/Master-Dynamic-Earphones-Connectivity-Tortoiseshell/dp/B07H8S4N36>>.\*

\* cited by examiner

*Primary Examiner* — Barbara Fox

*Assistant Examiner* — Messina L Smith

(74) *Attorney, Agent, or Firm* — Perkins Coie LLP

(57) **CLAIM**

The ornamental design for an earphone, as shown and described.

**DESCRIPTION**

FIG. 1 is a perspective view of an earphone showing our design, as viewed from the top and front.

FIG. 2 is a perspective view thereof, as viewed from the bottom and back.

FIG. 3 is an outer side elevation view thereof.

FIG. 4 is an inner side elevation view thereof.

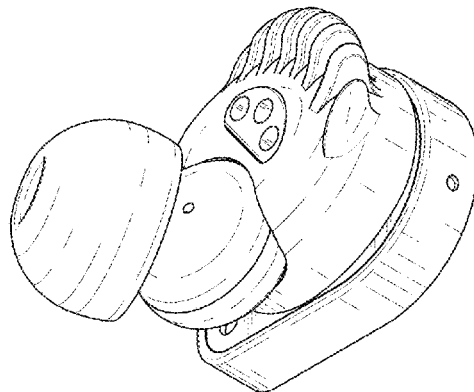
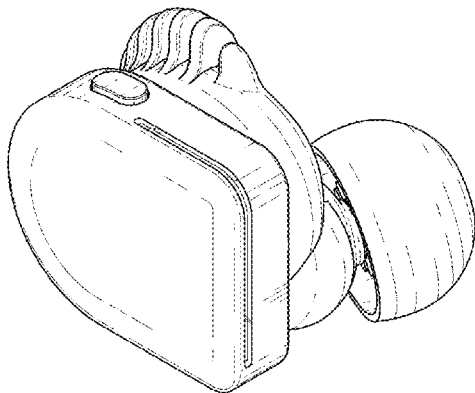
FIG. 5 is a front elevation view thereof.

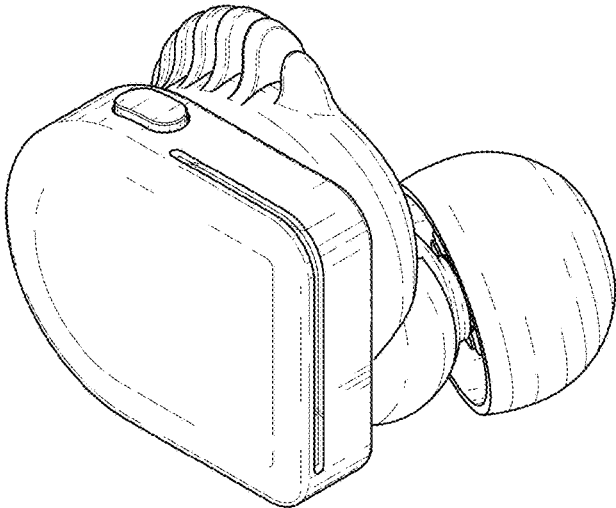
FIG. 6 is a back elevation view thereof.

FIG. 7 is a top plan view thereof; and,

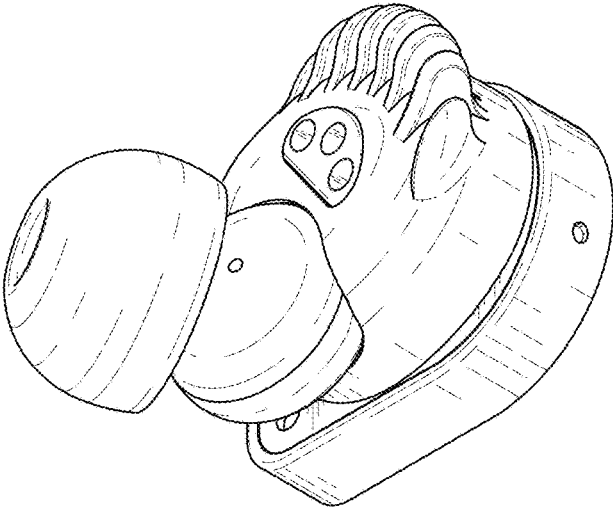
FIG. 8 is a bottom plan view thereof.

**1 Claim, 4 Drawing Sheets**

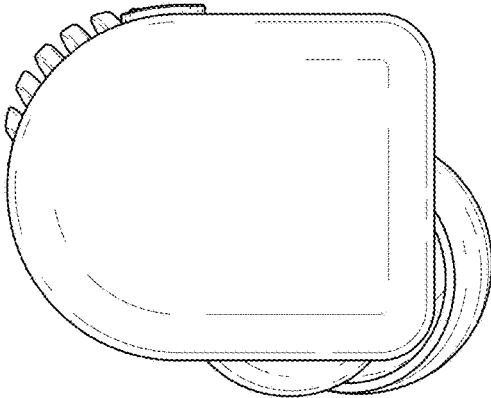




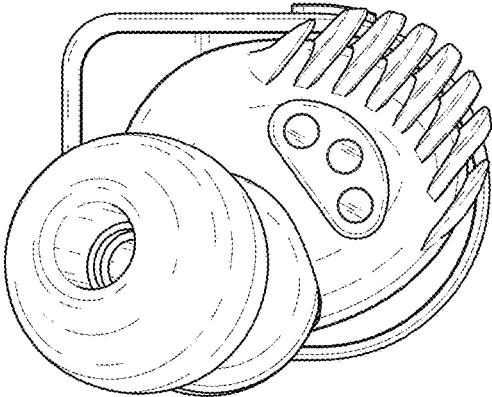
*Fig. 1*



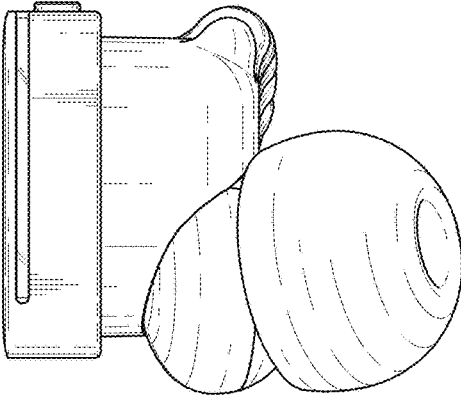
*Fig. 2*



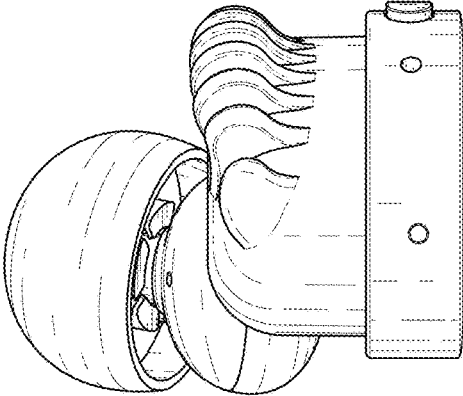
*Fig. 3*



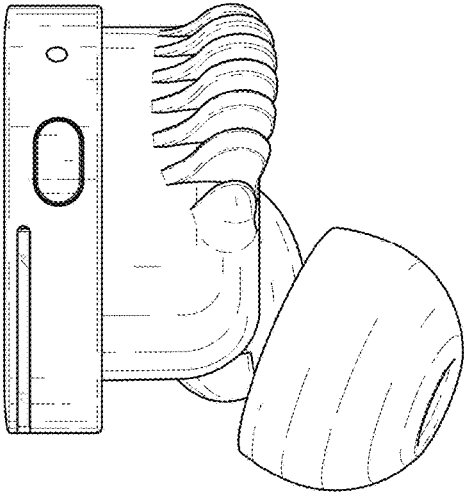
*Fig. 4*



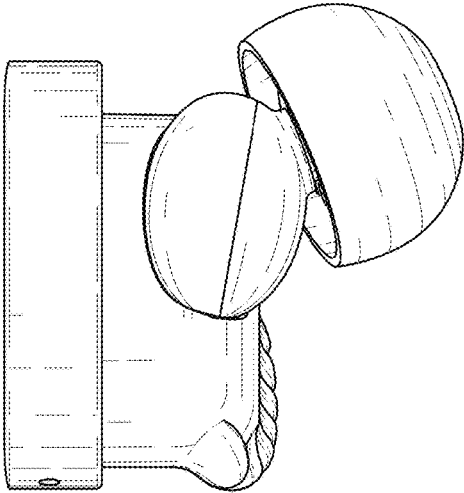
*Fig. 5*



*Fig. 6*



*Fig. 7*



*Fig. 8*