



US00D717544S

(12) **United States Design Patent**
Wang et al.

(10) **Patent No.:** **US D717,544 S**

(45) **Date of Patent:** **** Nov. 18, 2014**

(54) **BAG WITH FEET**

(71) Applicant: **Alexander Wang Incorporated**, New York, NY (US)

(72) Inventors: **Alexander Wang**, New York, NY (US);
Claudia Kim, Brooklyn, NY (US)

(73) Assignee: **Alexander Wang Incorporated**, New York, NY (US)

(**) Term: **14 Years**

(21) Appl. No.: **29/445,106**

(22) Filed: **Feb. 7, 2013**

(51) **LOC (10) Cl.** **03-01**

(52) **U.S. Cl.**
USPC **D3/318**

(58) **Field of Classification Search**
CPC A45C 1/02
USPC D3/232-233, 240-243, 245-246, 318;
150/100, 103-110, 113-114, 117-119

See application file for complete search history.

(56) **References Cited**

U.S. PATENT DOCUMENTS

D631,656 S * 2/2011 Della Valle D3/243
D631,657 S * 2/2011 Della Valle D3/243

* cited by examiner

Primary Examiner — Holly Baynham

(74) *Attorney, Agent, or Firm* — McCarter & English, LLP

(57) **CLAIM**

The ornamental design for a bag with feet, as shown.

DESCRIPTION

FIG. 1 is a front perspective view of a bag with feet showing our new design;

FIG. 2 is a front view thereof;

FIG. 3 is a rear view thereof;

FIG. 4 is a right side view thereof;

FIG. 5 is a left side view thereof;

FIG. 6 is a top view thereof; and,

FIG. 7 is a bottom view thereof.

The broken lines showing the body of the bag are for the purposes of illustrating environment and forms no part of the claimed design.

1 Claim, 5 Drawing Sheets

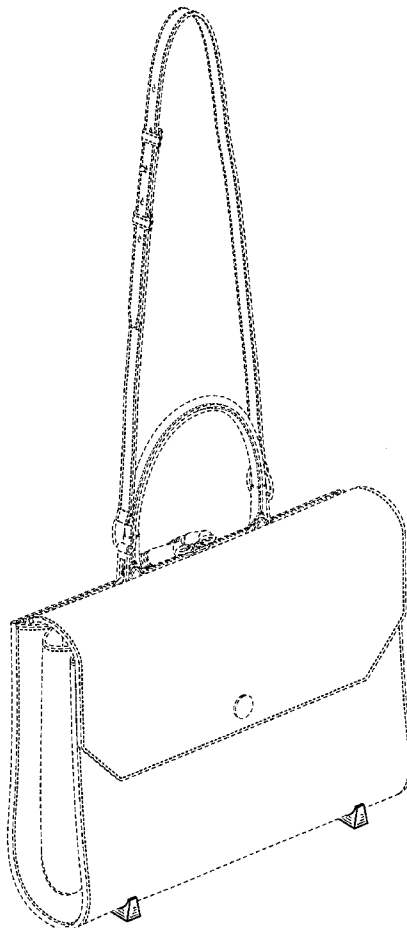

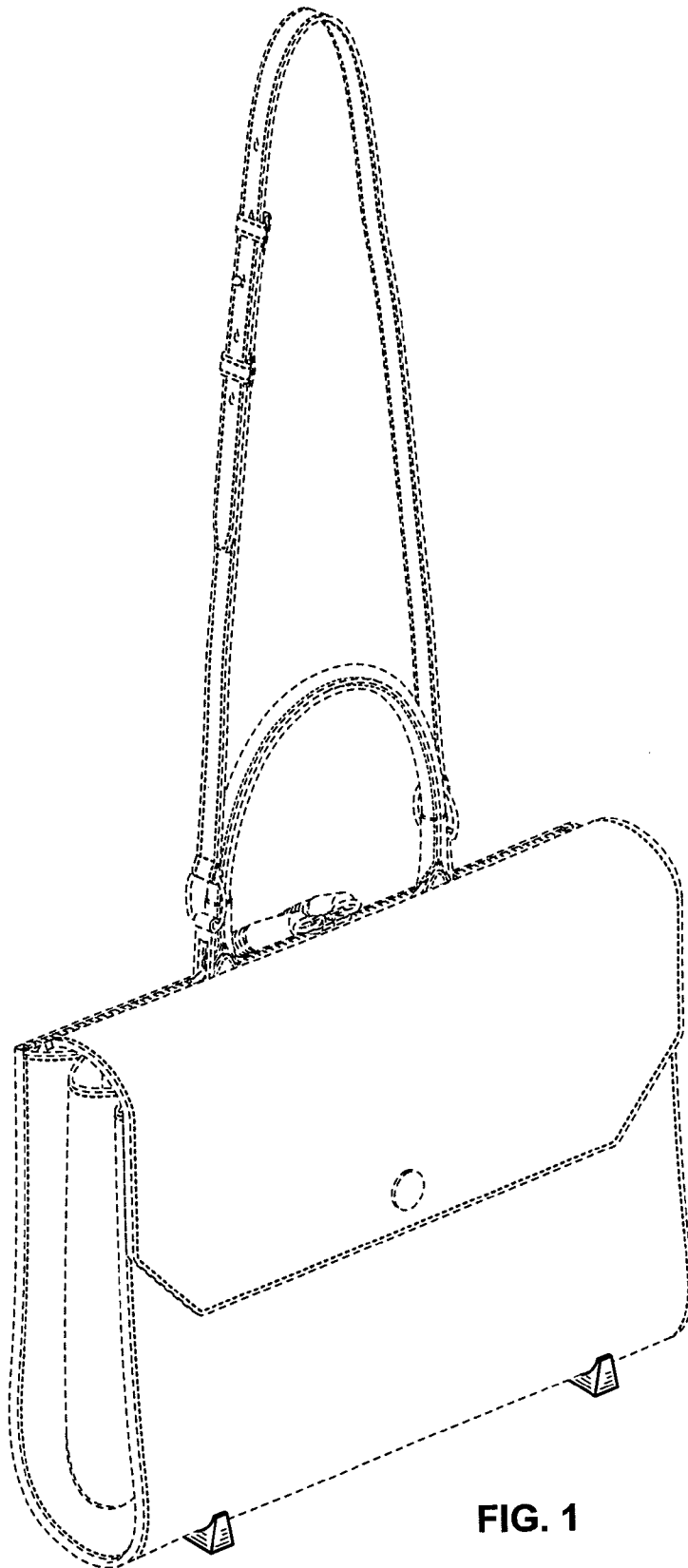

FIG. 1

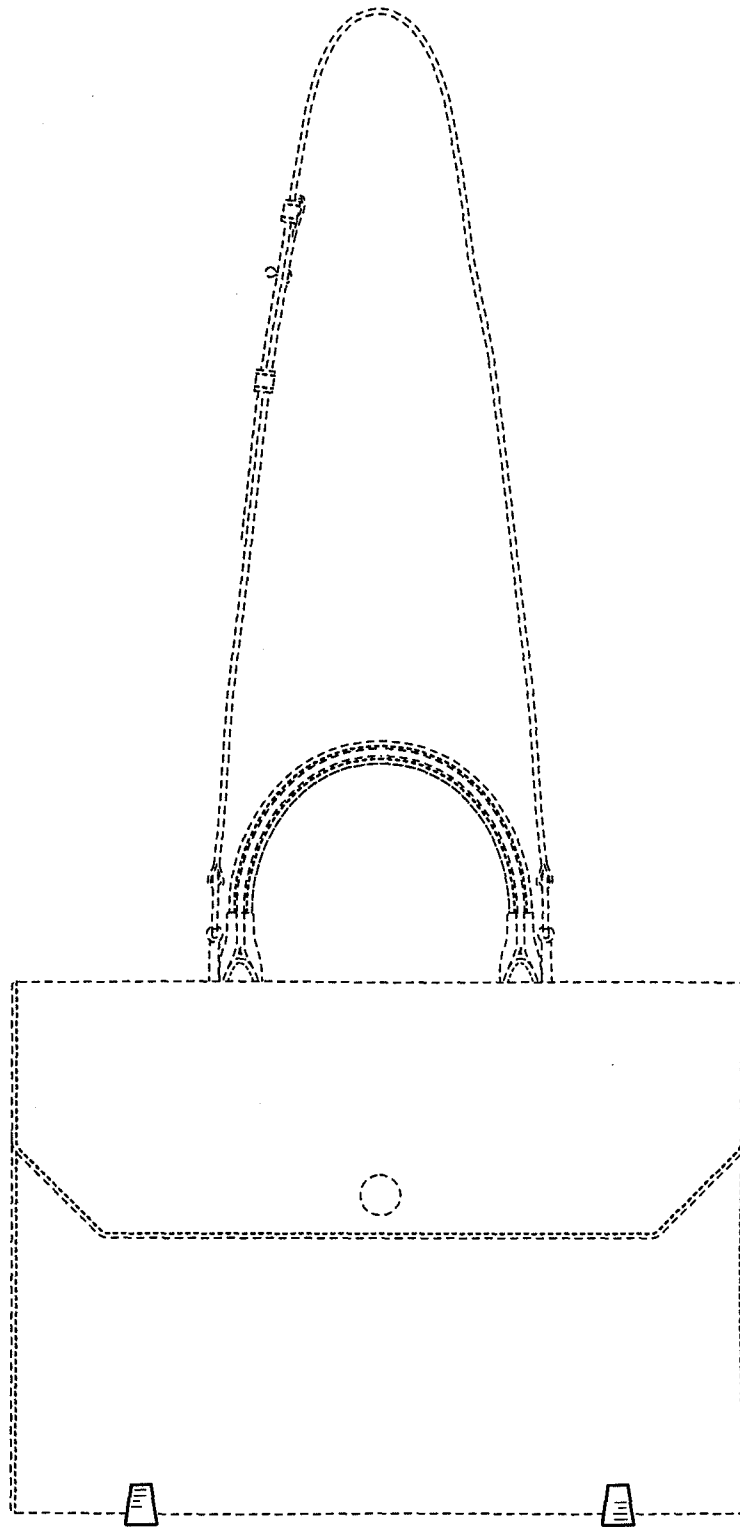

FIG. 2

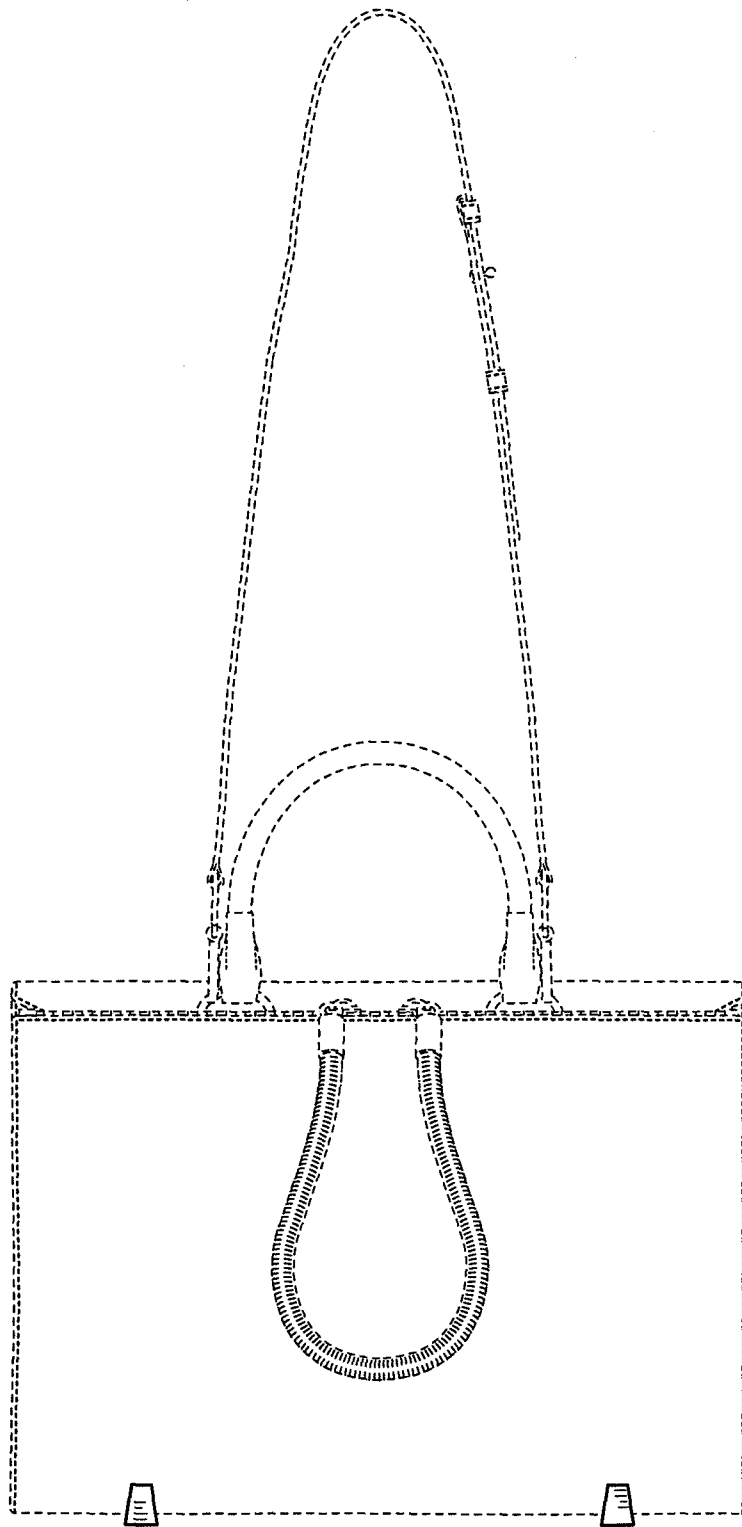

FIG. 3

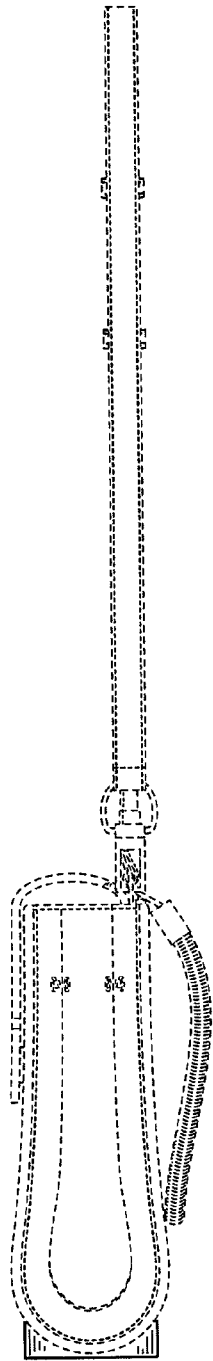

FIG. 4

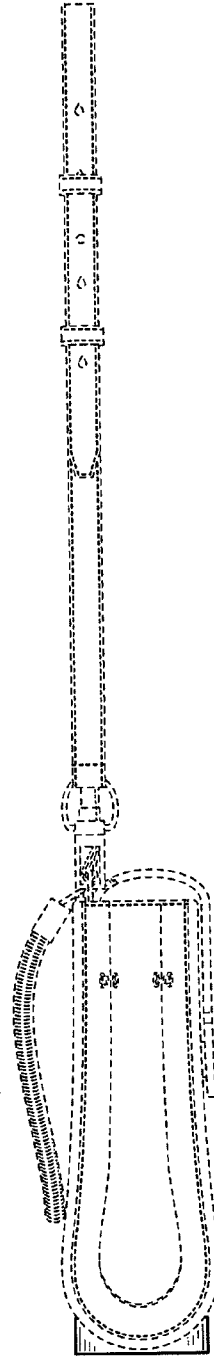

FIG. 5

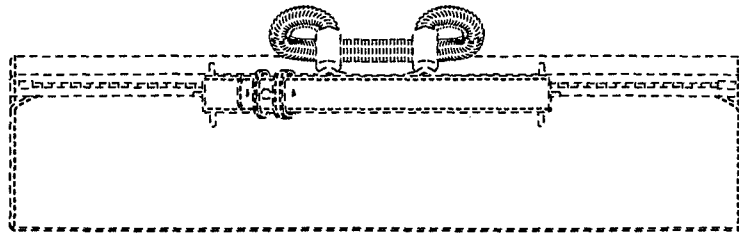

FIG. 6

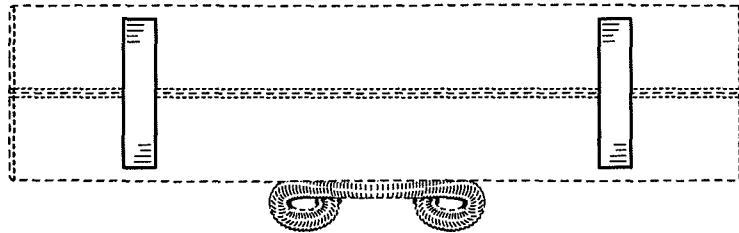

FIG. 7