



US00D760090S

(12) **United States Design Patent**
Braz et al.

(10) **Patent No.:** **US D760,090 S**

(45) **Date of Patent:** **** Jun. 28, 2016**

(54) **COMBINED CONTAINER AND CAP**

FOREIGN PATENT DOCUMENTS

(75) Inventors: **Felipe Carion Braz**, Sao Paulo (BR);
Romulo Zamberlan, Sao Paulo (BR);
Gustavo Senna Chelles, Sao Paulo
(BR); **Miriam Romy Hayashi**, Sao
Paulo (BR); **Daniella Karine Brochado**,
Sao Paulo (BR)

CN 300812202 * 8/2006
CN 3597199 * 1/2007

(Continued)

Primary Examiner — Catherine Tuttle

(74) *Attorney, Agent, or Firm* — B. Aaron Schulman, Esq.;
Stites & Harbison, PLLC.

(73) Assignee: **NATURA COSMETICOS S.A.**, São
Paulo (BR)

(57) **CLAIM**

(**) Term: **14 Years**

We claim the ornamental design for the combined container
and cap, as shown and described.

(21) Appl. No.: **29/356,059**

DESCRIPTION

(22) Filed: **Feb. 19, 2010**

(30) **Foreign Application Priority Data**

Aug. 20, 2009 (BR) DI6903231

(51) **LOC (10) Cl.** **09-01**

(52) **U.S. Cl.**
USPC **D9/688**

(58) **Field of Classification Search**

USPC D9/682-694, 500-505, 447-450;
D28/5, 7, 76-91.1; 222/129, 135,
222/153.01, 153.03, 153.04, 153.09,
222/153.11-153.14, 182, 631, 635, 209,
222/211-213, 215, 321.7-321.9, 372, 373,
222/378, 379, 383.1, 384-386, 398, 400.7,
222/400.8, 401, 402.1-402.25

See application file for complete search history.

(56) **References Cited**

U.S. PATENT DOCUMENTS

1,770,093 A * 7/1930 West 222/547
3,656,660 A * 4/1972 Mueller 222/94
D337,939 S * 8/1993 Smith, Jr. D9/726
5,489,026 A * 2/1996 D'Aloia 206/570
D385,793 S * 11/1997 Marsal D9/503

(Continued)

FIG. 1 is a perspective view showing our new design for a
combined container and cap;
FIG. 2 is a rear view of FIG. 1;
FIG. 3 is a left side view of FIG. 1;
FIG. 4 is a right side view of FIG. 1;
FIG. 5 is a top view of FIG. 1;
FIG. 6 is a bottom view of FIG. 1;
FIG. 7 is a perspective view showing a second embodiment of
our new design for the combined container and cap;
FIG. 8 is a rear view of FIG. 7;
FIG. 9 is a left side view of FIG. 7;
FIG. 10 is a right side view of FIG. 7;
FIG. 11 is a top view of FIG. 7;
FIG. 12 is a bottom view of FIG. 7;
FIG. 13 is a perspective view showing a third embodiment of
our new design for the combined container and cap;
FIG. 14 is a rear view of FIG. 13;
FIG. 15 is a left side view of FIG. 13;
FIG. 16 is a right side view of FIG. 13;
FIG. 17 is a top view of FIG. 13;
FIG. 18 is a bottom view of FIG. 13; and,
FIG. 19 is an exploded perspective view of FIGS. 1-6.
The broken lines are included for the purpose of illustrating
internal portions of the container that form no part of the
claimed design.

1 Claim, 9 Drawing Sheets

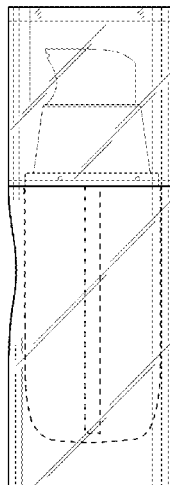
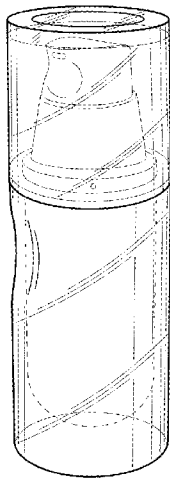

(56)

References Cited

FOREIGN PATENT DOCUMENTS

U.S. PATENT DOCUMENTS

D406,054	S	*	2/1999	Wagner	D9/725
D406,761	S	*	3/1999	Garcia	D9/434
D413,257	S	*	8/1999	Favre	D9/690
D413,793	S	*	9/1999	Favre	D9/692
5,950,880	A	*	9/1999	Garcia	222/321.7
D440,150	S	*	4/2001	Tsai	D9/689
D463,746	S	*	10/2002	de Baschmakoff	D9/500
D472,152	S	*	3/2003	Joubert	D9/529
D515,420	S	*	2/2006	Gardet	D9/448
D516,909	S	*	3/2006	Bloc	D9/434
D521,386	S	*	5/2006	Priestman	D9/529
D570,051	S	*	5/2008	Bakic	D28/88
D570,707	S	*	6/2008	Blasko et al.	D9/689
D578,894	S	*	10/2008	Seum et al.	D9/529
D615,419	S	*	5/2010	Owen	D9/726
D628,086	S	*	11/2010	Tanner et al.	D9/688

CN	3625597	*	3/2007
CN	300806249	*	7/2008
CN	300903367	*	4/2009
EM	000117890-0001	*	3/2004
EM	000187380-0008	*	11/2004
EM	000187380-0009	*	11/2004
KR	300377408.0000	*	3/2005
KR	300379458.0000	*	4/2005
KR	300407533.0000	*	2/2006
KR	300440382.0000	*	2/2007
KR	300481562.0000	*	2/2008
KR	300507715.0000	*	10/2008
KR	300522249.0000	*	3/2009
KR	300530992.0000	*	6/2009
KR	300536267.0000	*	8/2009

* cited by examiner

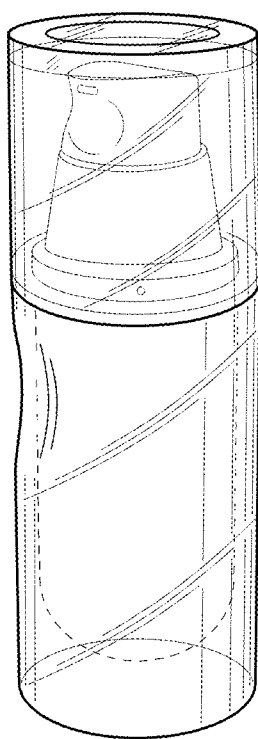

FIG. 1

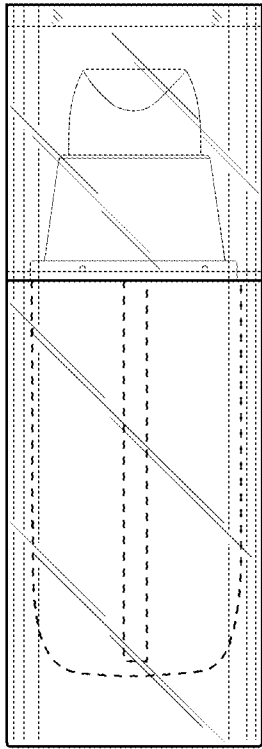

FIG. 2

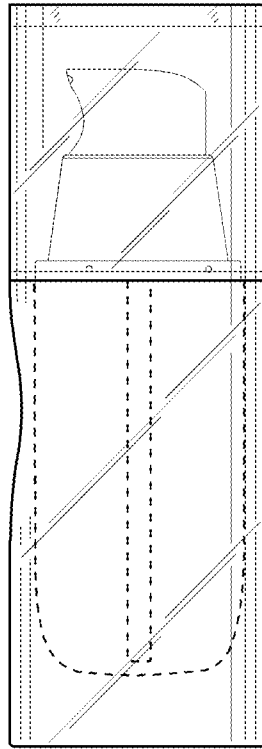

FIG. 3

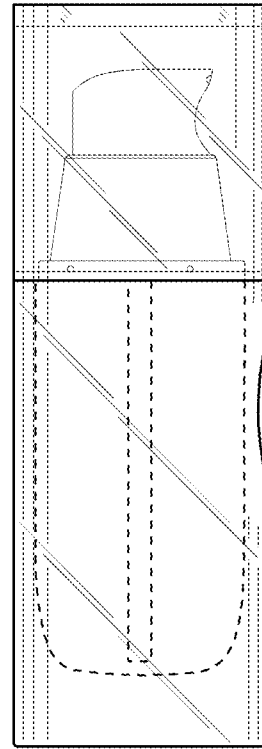

FIG. 4

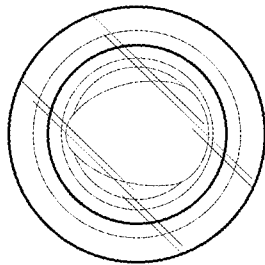

FIG. 5

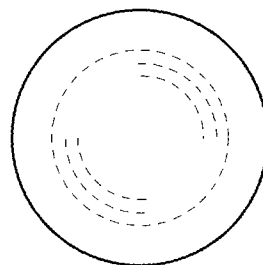

FIG. 6

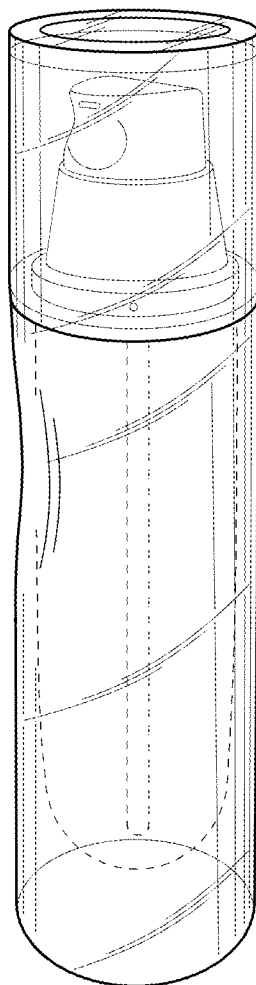

FIG. 7

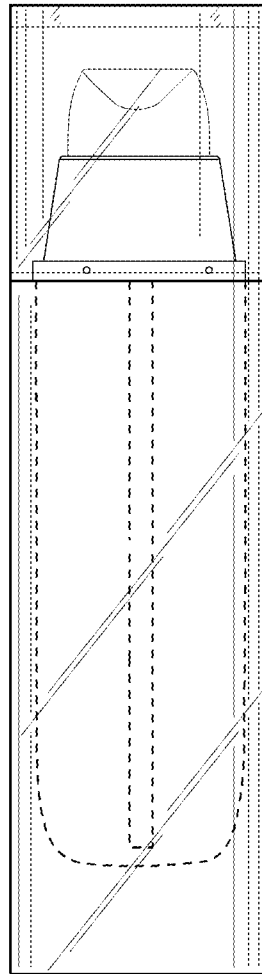

FIG. 8

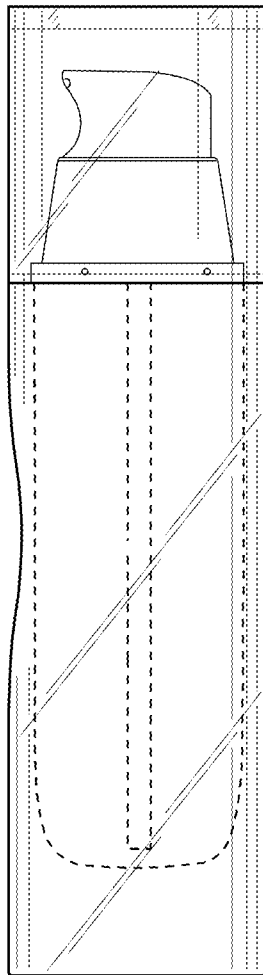

FIG. 9

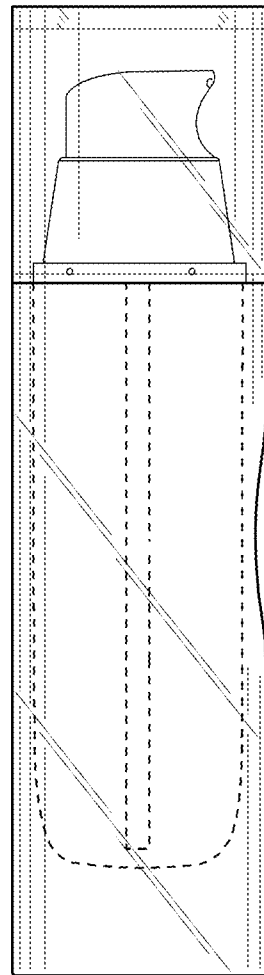

FIG. 10

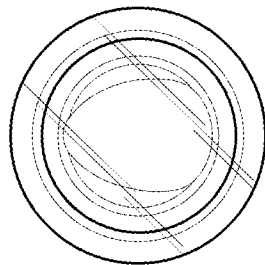

FIG. 11

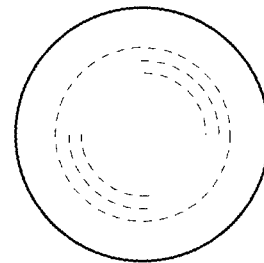

FIG. 12

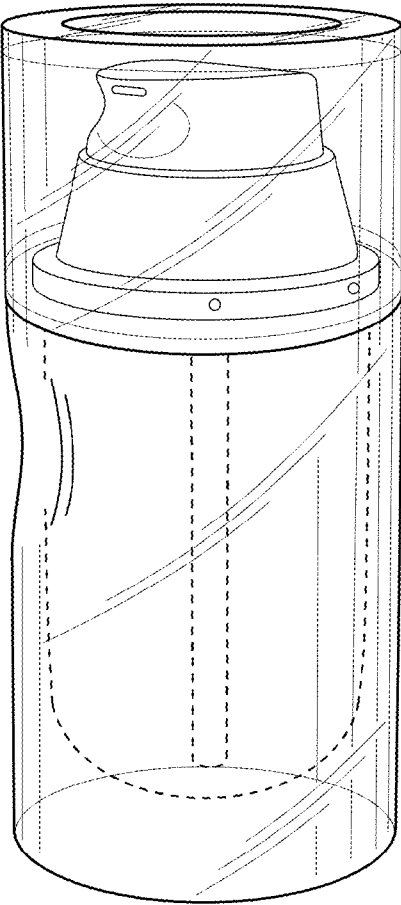

FIG. 13

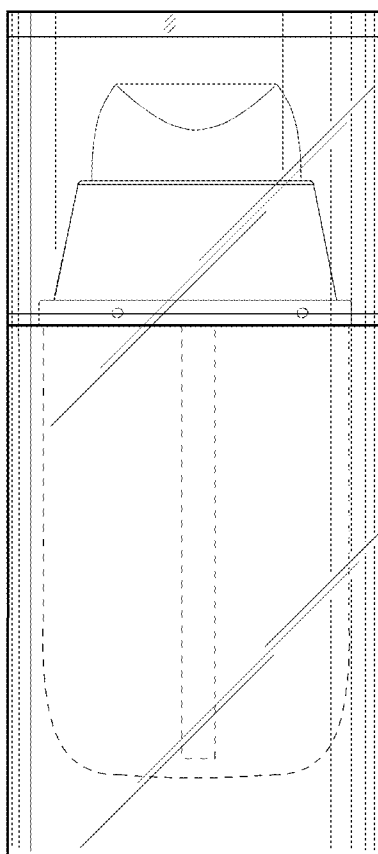

FIG. 14

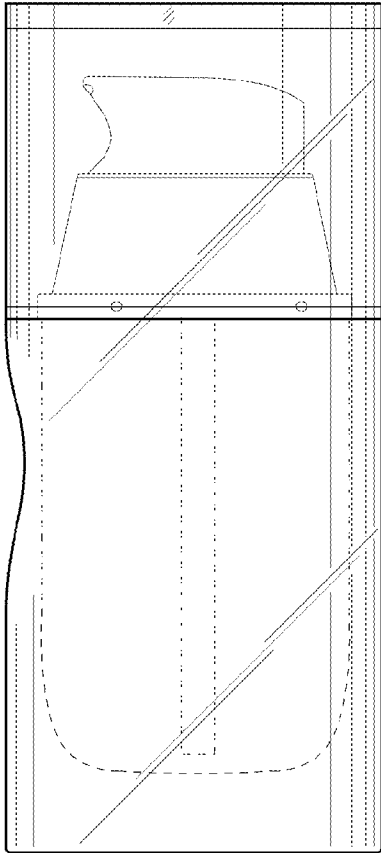

FIG. 15

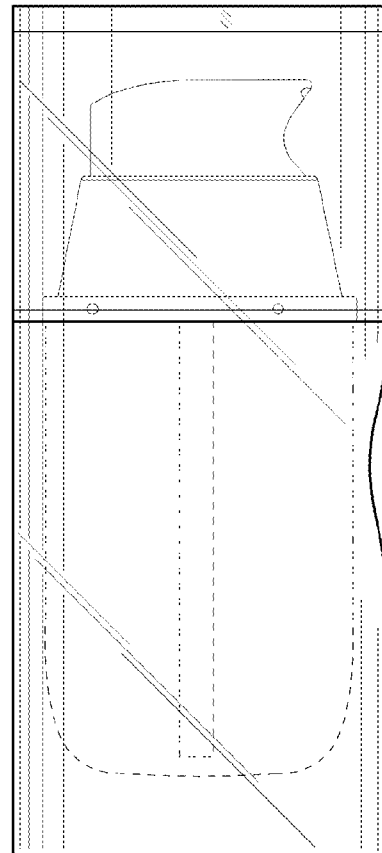

FIG. 16

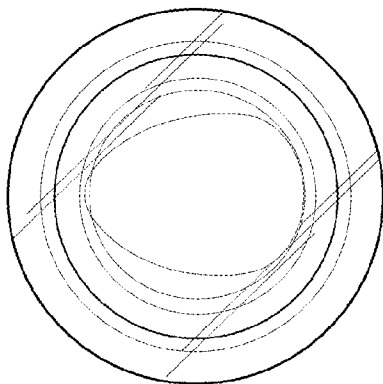

FIG. 17

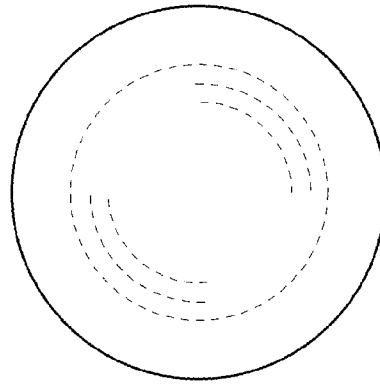

FIG. 18

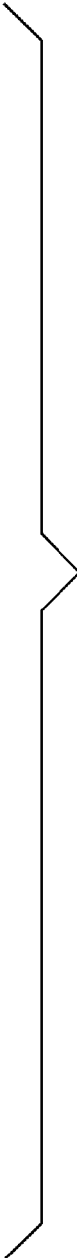
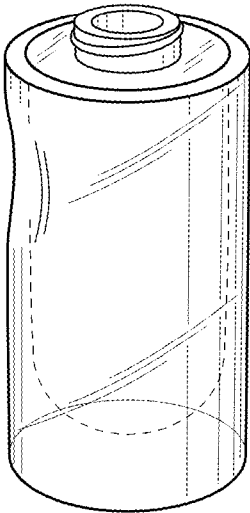
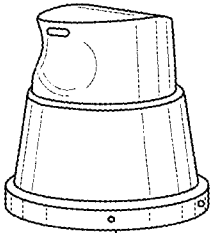
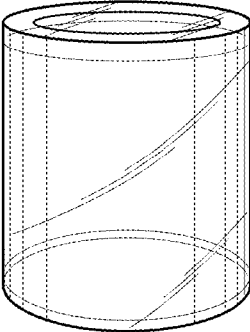

FIG. 19