

FOR THE PURPOSES OF INFORMATION ONLY

Codes used to identify States party to the PCT on the front pages of pamphlets publishing international applications under the PCT.

AL	Albania	ES	Spain	LS	Lesotho	SI	Slovenia
AM	Armenia	FI	Finland	LT	Lithuania	SK	Slovakia
AT	Austria	FR	France	LU	Luxembourg	SN	Senegal
AU	Australia	GA	Gabon	LV	Latvia	SZ	Swaziland
AZ	Azerbaijan	GB	United Kingdom	MC	Monaco	TD	Chad
BA	Bosnia and Herzegovina	GE	Georgia	MD	Republic of Moldova	TG	Togo
BB	Barbados	GH	Ghana	MG	Madagascar	TJ	Tajikistan
BE	Belgium	GN	Guinea	MK	The former Yugoslav Republic of Macedonia	TM	Turkmenistan
BF	Burkina Faso	GR	Greece	ML	Mali	TR	Turkey
BG	Bulgaria	HU	Hungary	MN	Mongolia	TT	Trinidad and Tobago
BJ	Benin	IE	Ireland	MR	Mauritania	UA	Ukraine
BR	Brazil	IL	Israel	MW	Malawi	UG	Uganda
BY	Belarus	IS	Iceland	MX	Mexico	US	United States of America
CA	Canada	IT	Italy	NE	Niger	UZ	Uzbekistan
CF	Central African Republic	JP	Japan	NL	Netherlands	VN	Viet Nam
CG	Congo	KE	Kenya	NO	Norway	YU	Yugoslavia
CH	Switzerland	KG	Kyrgyzstan	NZ	New Zealand	ZW	Zimbabwe
CI	Côte d'Ivoire	KP	Democratic People's Republic of Korea	PL	Poland		
CM	Cameroon	KR	Republic of Korea	PT	Portugal		
CN	China	KZ	Kazakstan	RO	Romania		
CU	Cuba	LC	Saint Lucia	RU	Russian Federation		
CZ	Czech Republic	LI	Liechtenstein	SD	Sudan		
DE	Germany	LK	Sri Lanka	SE	Sweden		
DK	Denmark	LR	Liberia	SG	Singapore		
EE	Estonia						

Title: Chimaeric adenoviruses

The invention relates to the field of molecular genetics and medicine. In particular the present invention relates to the field of gene therapy, more in particular to gene therapy using viruses, especially adenoviruses.

5 In gene therapy, genetic information is delivered to a host cell in order to either correct (supplement) a genetic deficiency in said cell, or to inhibit an unwanted function in said cell, or to eliminate said host cell. Of course the genetic information can also be intended to provide the host
10 cell with a wanted function, for instance to supply a secreted protein to treat other cells of the host, etc.

Thus there are basically three different approaches in gene therapy, one directed towards compensating a deficiency present in a (mammalian) host; the second directed towards
15 the removal or elimination of unwanted substances (organisms or cells) and the third towards providing a cell with a wanted function.

For the purpose of gene therapy, adenoviruses have been
20 proposed as suitable vehicles to deliver genes to the host. Gene-transfer vectors derived from adenoviruses (so-called adenoviral vectors) have a number of features that make them particularly useful for gene transfer. 1) the biology of the adenoviruses is characterized in detail, 2) the adenovirus
25 is not associated with severe human pathology, 3) the virus is extremely efficient in introducing its DNA into the host cell, 4) the virus can infect a wide variety of cells and has a broad host-range, 5) the virus can be produced at high virus titers in large quantities, and 6) the virus can be
30 rendered replication defective by deletion of the early-region 1 (E1) of the viral genome (Brody et al, 1994). However, there are still drawbacks associated with the use of adenoviral vectors. Typically adenoviruses, especially the well investigated serotypes usually elicit an immune
35 response by a host into which they are introduced. Also,

although the virus generally spoken has a wide infection range, there is a problem in targeting certain cells and tissues. Also, the replication and other functions of the adenovirus are not always very well suited for the cells
5 which are to be provided with the additional genetic material.

The adenovirus genome is a linear double-stranded DNA molecule of approximately 36000 base pairs. The adenovirus
10 DNA contains identical Inverted Terminal Repeats (ITR) of approximately 90-140 base pairs with the exact length depending on the serotype. The viral origins of replication are within the ITRs exactly at the genome ends.
Most adenoviral vectors currently used in gene therapy have
15 a deletion in the E1 region, where novel genetic information can be introduced. The E1 deletion renders the recombinant virus replication defective (Levrero et al, 1991). It has been demonstrated extensively that recombinant adenovirus, in particular serotype 5 is suitable for efficient transfer
20 of genes *in vivo* to the liver, the airway epithelium and solid tumors in animal models and human xenografts in immunodeficient mice (Bout, 1996; Blaese et al., 1995).
Thus, preferred methods for *in vivo* gene transfer into
25 target cells make use of adenoviral vectors as gene delivery vehicles.

At present, six different subgroups of human adenoviruses have been proposed which in total encompasses 51 distinct adenovirus serotypes (see table 1). Besides these human
30 adenoviruses an extensive number of animal adenoviruses have been identified (see Ishibashi et al, 1983).

A serotype is defined on the basis of its immunological distinctiveness as determined by quantitative neutralization
35 with animal antisera (horse, rabbit). If neutralization shows a certain degree of cross-reaction between two viruses,

distinctiveness of serotype is assumed if A) the hemagglutinins are unrelated, as shown by lack of cross-reaction on hemagglutination-inhibition, or B) substantial biophysical/ biochemical differences in DNA exist (Francki et al, 1991). The nine serotypes identified last (42-51) were isolated for the first time from HIV- infected patients (Hierholzer et al 1988; Schnurr et al 1993; De Jong et al 1998). For reasons not well understood, most of such immunocompromised patients shed adenoviruses that were rarely or never isolated from immuno-competent individuals (Hierholzer et al 1988, 1992; Khoo et al, 1995, De Jong et al, 1998).

Besides differences towards the sensitivity against neutralizing antibodies of different adenovirus serotypes, it has also been shown that adenoviruses in subgroup C such as Ad2, and Ad5 bind to different receptors as compared to adenoviruses from subgroup B such as Ad3 (Defer et al, 1990). Likewise, it was demonstrated that receptor specificity could be altered by exchanging the Ad3 with the Ad 5 knob protein, and vice versa (Krasnykh et al, 1996; Stevenson et al, 1995, 1997). The adenovirus serotype 5 is most widely used for gene therapy purposes. Similar to serotypes 2, 4 and 7, serotype 5 has a natural affiliation towards lung epithelia and other respiratory tissues. In contrast, it is known that, for instance, serotypes 40 and 41 have a natural affiliation towards the gastrointestinal tract. For a detailed overview of the disease association of the different adenovirus serotypes see table 2. The serotypes described above, differ in at least capsid proteins (penton-base, hexon), proteins responsible for cell binding (fiber protein), and proteins involved in adenovirus replication.

One of the major problems of adenovirus gene therapy is thus that none of the above described serotypes are ideally suitable for delivering additional genetic material to host cells. Some have a somewhat limited host range, but have the

benefit of being less immunogenic, some are the other way round. Some have a problem of being of a limited virulence, but have a broad host range and/or a reduced immunogenicity. To make things even more complicated this variation in the adenovirus serotypes is also very dependent on the host to be treated. Some hosts may already have encountered certain serotypes and thus mount a strong immune response to said serotype or a related serotype. Persons skilled in the art know that there are many other variations on this same theme.

The present invention now makes use of the fact that some adenoviruses have lower immunogenicity than others, which others typically excel in one of the other requirements for an efficient gene therapy regime, such as having a high specificity for a certain group of host cells, a good replication machinery in such host cells, a high rate of infection in certain host cells, etc. The invention thus provides chimaeric adenoviruses having the useful properties of at least two adenoviruses of different serotypes. Typically, more than two requirements from the above non-exhaustive list are required to obtain an adenovirus capable of efficiently transferring additional material to a host cell and therefore the invention provides adenovirus derived vectors which can be used as cassettes to insert different adenoviral genes from different adenoviral serotypes at the required sites for obtaining a vector capable of expressing a chimaeric adenovirus, whereby of course also a gene of interest can be inserted at for instance the site of E1 of the original adenovirus from which the vector is derived. In this manner the chimaeric adenovirus to be produced can be adapted to the requirements and needs of certain hosts in need of gene therapy for certain disorders. Of course to enable this production a packaging cell will generally be needed in order to produce sufficient amount of safe chimaeric adenoviruses.

Thus in one embodiment the invention provides a chimaeric adenovirus comprising at least a part of a fiber protein and/or a protein involved in replication of an adenovirus serotype providing the chimaeric virus with a desired host range and/or improved replication properties and at least a part of a penton or hexon protein from another less antigenic adenovirus serotype resulting in a less antigenic chimaeric adenovirus. Typically such a virus will be produced using a vector (typically a plasmid, a cosmid or baculovirus system) which vector is of course also part of the present invention. A preferred vector is a vector which can be used to make a chimaeric recombinant virus specifically adapted to the host to be treated and the disorder to be treated. Such a vector is another embodiment of the present invention. Thus the invention also provides a recombinant vector derived from an adenovirus comprising at least one ITR and a packaging signal, having an insertion site for a nucleic acid sequence of interest, and further having an insertion site for functionally inserting a gene encoding a penton and/or a hexon protein of a first serotype of adenovirus and having an insertion site for a gene encoding a fiber protein of a second adenovirus of a different serotype, and/or an insertion site for a gene derived from a serotype having improved characteristics in the function carried out by that gene or its product. Typically the invention provides cassettes which allow for the production of any desired chimaeric adenovirus, be it only derived from two serotypes or as many as needed to obtain the desired characteristics, whereby it is not always necessary that all characteristics are the best when seen as single properties. It may not even be necessary, for instance, to always alter penton and/or hexon together with another part of adenovirus genes. Sometimes the immunogenicity needs not be altered together with other properties. However, it is preferred to use penton and/or hexon genes from less immunogenic adenovirus serotypes. An important feature of the present invention is

the means to produce the chimaeric virus. Typically, one does not want an adenovirus batch to be administered to the host cell which contains replication competent adenovirus, although this is not always true. In general therefor it is
5 desired to omit a number of genes (but at least one) from the adenoviral genome on the vector encoding the chimaeric virus and to supply these genes in the genome of the cell in which the vector is brought to produce chimaeric adenovirus. Such a cell is usually called a packaging cell. The invention thus
10 also provides a packaging cell for producing a chimaeric adenovirus according to the invention, comprising in trans all elements necessary for adenovirus production not present on the adenoviral vector according to the invention. Typically vector and packaging cell have to be adapted to one
15 another in that they have all the necessary elements, but that they do not have overlapping elements which lead to replication competent virus by recombination. Thus the invention also provides a kit of parts comprising a packaging cell according to the invention and a recombinant
20 vector according the invention whereby there is essentially no sequence overlap leading to recombination resulting in the production of replication competent adenovirus between said cell and said vector. In order to be able to precisely adapt the viral vector and
25 provide the chimaeric virus with the desired properties at will, it is preferred that a library of adenoviral genes is provided whereby the genes are located within restriction sites. Typically it is preferred to have same kinds of genes of different serotypes within the same restriction sites and
30 to have that same restriction site in the adenoviral vector used to produce the chimaeric virus. If all sites for different genes are unique then a system to pick and choose from has been made. One can cut a penton gene from the desired serotype from the library and insert it at the same
35 site in the vector. One can then use a different restriction enzyme to cut a replication gene from the bank of a different

serotype using another restriction enzyme and insert that gene at the corresponding restriction site in the chimaeric vector. Thus it is to be preferred to have a vector according to the invention where the insertion sites are different and preferably unique restriction sites. Preferably this vector is combined with a library having the corresponding genes within the same restriction sites. Methods to use this library and the vector are within the skill in the art and are part of the present invention. Typically such a method comprises a number of restriction and ligation steps and expression of the result in a packaging cell. Also one can use a library from which the different desired adenoviral genes are obtained through homologous recombination or a combination of restriction and recombination. Thus the invention provides a method for producing a chimaeric adenovirus having a desired host range and diminished antigenicity, comprising providing a vector according to the invention having the desired insertion sites, inserting into said vector at least a functional part of a penton or hexon protein derived from an adenovirus serotype having relatively low antigenicity, inserting at least a functional part of a fiber protein derived from an adenovirus serotype having the desired host range and transfecting said vector in a packaging cell according to the invention and allowing for production of chimaeric viral particles. Of course other combinations of other viral genes originating from different serotypes can also be inserted as disclosed herein before. An immunogenic response to adenovirus that typically occurs is the production of neutralizing antibodies by the host. This is typically a reason for selecting a penton, hexon and/or fiber of a less immunogenic serotype. Of course it may not be necessary to make chimaeric adenoviruses which have complete proteins from different serotypes. It is well within the skill of the art to produce chimaeric proteins, for instance in the case of fiber proteins it is very well possible to have the base of one

serotype and the shaft and the knob from another serotype. In this manner it becomes possible to have the parts of the protein responsible for assembly of viral particles originate from one serotype, thereby enhancing the production of intact viral particles. Thus the invention also provides a chimaeric adenovirus according to the invention, wherein the hexon, penton and/or fiber proteins are chimaeric proteins originating from different adenovirus serotypes. Besides generating chimaeric adenoviruses by swapping entire wild type hexon, penton, fiber (protein) genes etc. or parts thereof, it is also within the scope of the present invention to insert hexon, penton, fiber (protein) genes etc. carrying mutations such as point mutations, deletions, insertions etc. which can be easily screened for preferred characteristics such as temperature stability, assembly, anchoring, redirected infection, altered immune response etc. Again other chimaeric combinations can also be produced and are within the scope of the present invention.

The availability of a library of nucleic acids derived from different serotypes allows, among others, the generation of a library of chimaeric adenoviruses. The invention therefore further provides a library of chimaeric adenoviruses. In one embodiment the invention provides a library of chimaeric adenoviruses wherein said adenoviruses comprise chimaeric capsids, i.e. comprising capsid proteins derived at least in part from at least two different adenovirus serotypes. Preferably, nucleic acid and/or protein or parts thereof, from at least one representative adenovirus of each adenovirus subgroup is represented in said (chimaeric) adenovirus library. Preferably, nucleic acid and/or protein or parts thereof is derived from more than one representative of each adenovirus subgroup. Most preferably, said library comprises nucleic acid and/or protein or a part thereof, from essentially every known representative of each adenovirus subgroup. Nucleic acid and/or protein or parts

thereof derived from more than one representative adenovirus from each adenovirus subgroup in said (chimaeric) library is desired because a desirable property may not be a general property of a subgroup. Also, a desirable property of a subgroup of adenovirus may be expressed in different amounts on the various members of the subgroup. Ensuring that more than one representative of a subgroup is represented in the library thus warrants the selection of the best expressor of the desired property.

Typically, a library of chimaeric adenoviruses or a part thereof is used in screening assays to determine properties of said chimaeric adenoviruses. Any particular chimaeric adenovirus comprising particularly desirable properties can thereby be identified and subsequently be used in, for instance, the development of an improved nucleic acid delivery vehicle. Desirable properties said chimaeric adenovirus library may be screened for include, but are not limited to, target cell specificity, reduced immunogenicity, increased immunogenicity, re-directed neutralization, re-directed hemagglutination, improved infection efficiency, reduced toxicity, improved replication and/or improved pharmacokinetics such as altered tissue distribution upon in vivo administration. Comparison of properties of different chimaeric adenoviruses can lead to the delineation of adenovirus elements involved in providing an adenovirus with said property. Such knowledge can then be used to further optimize nucleic acid delivery vehicles. In one aspect the invention provides a selection of (chimaeric) adenoviruses with an improved capacity to transduce macrophage- or fibroblast-like cells compared to adenovirus 5, preferably said (chimaeric) adenoviruses comprise at least part of a tissue tropism determining part of a fiber protein of an adenovirus of subgroup B, or a derivative and/or analogue of said fiber protein. The invention further provides a selection of (chimaeric) adenoviruses with an improved capacity to transduce smooth muscle cells compared to

adenovirus 5, preferably said (chimaeric) adenoviruses comprise at least part of a tissue tropism determining part of a fiber protein of an adenovirus of subgroup B, or a derivative and/or analogue of said fiber protein. A

5 chimaeric adenovirus library of the invention may further be used to study adenovirus biology. Such a library is for instance very well suited to study differences in the biology of the various adenovirus serotypes. In one aspect the invention provides a selection of (chimaeric)

10 adenoviruses, capable of transducing a CAR negative cell. Preferably said CAR negative cell is a amnion fluid cell or a derivative thereof. Preferably said amnion fluid cell is a chorion villi cell or a derivative thereof. Preferably said CAR negative cell is a CAR negative hemopoietic cell, such

15 as but not limited to an erythroid precursor cell and/or a monocyte precursor cell and/or derivatives thereof. Preferably said (chimaeric) adenoviruses capable of transducing a CAR negative cell comprise at least an

20 adenovirus of subgroup D or F. In one aspect the invention provides a chimaeric adenovirus comprising a re-directed neutralization pattern compared to adenovirus 5. Re-directed neutralization is useful in a number of circumstances. For instance, but not limited to,

25 getting round pre-existing neutralizing antibodies in a patient administered with said chimaeric adenovirus. Pre-existing neutralizing antibodies would neutralize the adenovirus and thereby diminish the effective amount of virus administered. This effect is usually not desired in

30 for instance gene therapy settings wherein a nucleic acid is to be delivered to target cells. However, pre-existing neutralizing antibodies can for instance in other gene therapy applications be an advantage when the nucleic acid of interest delivered through said chimaeric adenovirus

35 should not be delivered to cells throughout the body. Local delivery for instance by using a needle in a solid tissue

combined with the presence of neutralizing antibodies in the blood that can neutralize leaking chimaeric adenovirus can in that case help to contain the transduction to a certain area.

5 In another aspect the invention provides a chimaeric adenovirus comprising a re-directed hemagglutination pattern compared to adenovirus 5. Re-directed hemagglutination is useful in a number of circumstances. Hemagglutinated material is preferentially taken up by macrophages and
10 derivatives and/or precursors. Thus enhanced hemagglutination of a chimaeric adenovirus is preferred in case where enhanced delivery of nucleic acid to said macrophages is desired. However, in general the target cell will not be said macrophages thus in those cases a reduced
15 hemagglutination is desired. A chimaeric adenovirus re-directed in its hemagglutination is useful for many applications which the person skilled art can now think of and thus form an integral part of the present invention.

20 **Detailed description.**

It has been demonstrated in mice that upon *in vivo* systemic delivery of recombinant adenovirus serotype 5 for gene
25 therapy purposes approximately 99% of the virus is trapped in the liver (Herz et al, 1993). Therefore, alteration of the adenovirus serotype 5 host cell range to be able to target other organs *in vivo* is a major interest of the invention, particularly in combination with other alterations, in particular the immunogenicity.

30 The initial step for successful infection is binding of adenovirus to its target cell, a process mediated through fiber protein. The fiber protein has a trimeric structure (Stouten et al, 1992) with different lengths depending on
35 the virus serotype (Signas et al 1985; Kidd et all 1993). Different serotypes have polypeptides with structurally

similar N and C termini, but different middle stem regions. N-terminally, the first 30 amino acids are involved in anchoring of the fiber to the penton base (Chroboczek et al, 1995), especially the conserved FNPVYP region in the tail (Arnberg et al 1997). The C-terminus, or knob, is responsible for initial interaction with the cellular adenovirus receptor. After this initial binding secondary binding between the capsid penton base and cell-surface integrins leads to internalization of viral particles in coated pits and endocytosis (Morgan et al, 1969; Svensson et al, 1984; Varga et al, 1992; Greber et al, 1993; Wickham et al, 1994). Integrins are $\alpha\beta$ -heterodimers of which at least 14 α -subunits and 8 β -subunits have been identified (Hynes et al, 1992). The array of integrins expressed in cells is complex and will vary between cell types and cellular environment. Although the knob contains some conserved regions, between serotypes, knob proteins show a high degree of variability, indicating that different adenovirus receptors exist. For instance, it has been demonstrated that adenoviruses of subgroup C (Ad2, Ad5) and adenoviruses of subgroup B (Ad3) bind to different receptors (Defner et al, 1990). The fiber protein also contains the type specific γ -antigen, which together with the ϵ -antigen of the hexon determines the serotype specificity. The γ -antigen is localized on the fiber and it is known that it consists of 17 amino acids (Eiz et al, 1997). The anti-fiber antibodies of the host are therefore directed to the trimeric structure of the knob. The anti-fiber antibodies together with antibodies directed against the penton base and hexon proteins are responsible for the neutralization of adenovirus particles. First the anti-fiber antibodies uncoat the adenovirus particles after which the penton base is accessible to the anti-penton base antibodies (Gahery-Segard et al, 1998). Although this seems to be a very effective way to neutralize adenovirus particles others have described

that the anti-hexon antibodies are the most effective ones in neutralization of the particles (Gall et al, 1996).

To obtain re-directed infection of recombinant adenovirus serotype 5, several approaches have been or still are under investigation. Wickham et al has altered the RGD (Arg, Gly, Asp) motif in the penton base which is believed to be responsible for the $\alpha_v\beta_3$ and $\alpha_v\beta_5$ integrin binding to the penton base. They have replaced this RGD motif by another peptide motif which is specific for the $\alpha_4\beta_1$ receptor. In this way targeting the adenovirus to a specific target cell could be accomplished (Wickham et al, 1995, 1996). Krasnykh et al has made use of the HI loop available in the knob. This loop is, based on X-ray crystallographics, located on the outside of the knob trimeric structure and therefore is thought not to contribute to the intramolecular interactions in the knob (Krasnykh et al, 1998). However, complete CAR independent infection was not observed.

It is an object of the present invention to provide a method and means by which adenoviruses can be constructed with an altered immune response, or with the absence or decreased infection in antigen presenting cells such as dendritic cells or macrophages. It is a further object of the present invention to provide methods for the generation of chimaeric adenoviruses as described above which can be targeted to specific cell types *in vitro* as well as *in vivo* have an altered tropism for certain cell types. It is a further object of the present invention to provide a method and means by which such an adenovirus can be used as a protein or nucleic acid delivery vehicle to a specific cell type or tissue.

The generation of chimaeric adenoviruses based on adenovirus serotype 5 with modified late genes is described. For this purpose, three plasmids, which together contain the complete adenovirus serotype 5 genome, were constructed. From these

plasmids the DNA encoding the adenovirus serotype 5 penton-base protein, hexon protein, and fiber protein were removed and replaced by linker DNA sequences which facilitate easy cloning. These plasmids subsequently served as template for the insertion of DNA encoding for penton-base protein, hexon protein, and fiber protein derived from different adenovirus, serotypes (human or animal). The DNAs derived from the different serotypes were obtained using the polymerase chain reaction technique in combination with (degenerate) oligonucleotides. At the former E1 location in the genome of adenovirus serotype 5, any gene of interest can be cloned. A single transfection procedure of the three plasmids together resulted in the formation of a recombinant chimaeric adenovirus. This new technology of libraries consisting of chimaeric adenoviruses thus allows for a rapid screening for improved recombinant adenoviral vectors for *in vitro* and *in vivo* gene therapy purposes.

Although successful introduction of changes in the adenovirus serotype 5 fiber and penton-base have been reported, the complex structure of knob and the limited knowledge of the precise amino acids interacting with CAR render such targeting approaches laborious and difficult. To overcome the limitations described above we used pre-existing adenovirus fibers, penton base proteins, and hexon proteins derived from other adenovirus serotypes. By generating chimaeric adenovirus serotype 5 libraries containing structural proteins of alternative adenovirus serotypes, we have developed a technology which enables rapid screening for a recombinant adenoviral vector with preferred characteristics.

In one aspect this invention describes the use of chimaeric adenoviruses to overcome, natural existing or induced, neutralizing host activity towards recombinant adenoviruses

administered *in vivo* for therapeutic applications. The host immune response is predominantly directed against penton base - and hexon proteins present in the adenoviral capsid and to a lesser extent directed to fiber.

5 The adenovirus serotypes are defined by the inability to cross-react with neutralizing antibodies in animal sera. Therefore chimaeric viruses based on for example adenovirus serotype 5 but chimaeric for penton base protein, and/ or hexon protein provoke an altered, less severe immune
10 response. The need for such chimaeric adenoviruses is stressed by observations that 1) repeated systemic delivery of recombinant adenovirus serotype 5 is unsuccessful due to formation of high titers of neutralizing antibodies against the recombinant adenovirus serotype 5 (Schulick et al,
15 1997), and 2) pre-existing or natural immunity. This aspect of the invention therefore circumvents the inability to repeat the administration of an adenovirus for gene therapy purposes. Preferably, the penton base-, hexon-, and fiber proteins are derived from adenoviruses in subgroup
20 B and D and are more specifically of the adenovirus serotype 16, 24, 33, 36, 38, 39, 42, and 50. This latter is because these serotypes are rarely isolated from humans indicating that low titers of circulating neutralizing antibodies are present against these serotypes.

25 In another aspect this invention describes chimaeric adenoviruses and methods to generate these viruses that have an altered tropism different from that of adenovirus serotype 5. For example, viruses based on adenovirus
30 serotype 5 but displaying any adenovirus fiber existing in nature. This chimaeric adenovirus serotype 5 is able to infect certain cell types more efficiently, or less efficiently *in vitro* and *in vivo* than the adenovirus serotype 5. Such cells include but are not limited to
35 endothelial cells, smooth muscle cells, dendritic cells, neuronal cells, glial cells, synovial cells, lung

epithelial cells, hemopoietic stem cells, monocytic/
macrophage cells etc.

In another aspect this invention describes methods which
5 identify chimaeric adenoviruses that display improved in
vitro amplification in static or suspension cell cultures.
Adenoviruses derived from different subgroups, but also
within one subgroup, display a high variability in
productive infection in cell types that are used for
10 production of recombinant adenovirus. Table 2 lists an
overview of different adenovirus serotypes and their
association with human disease, demonstrating that
replication of a given adenovirus serotype is enhanced in
certain cell types. For the production of recombinant
15 adenoviruses for gene therapy purposes, several cell lines
are available. These include but do not limit PER.C6, 911,
293, and E1 A549. These adenovirus producer cells may not be
the most suited cell types to amplify adenovirus serotype 5
based viruses. Therefore, in this aspect of the invention we
20 select adenoviruses from different serotypes based on their
ability to propagate for example on PER.C6 and use their
early genes (without E1) and ITRs to construct chimaeric
viruses which are superior in terms of propagation and thus
yield higher titers as compared to commonly used adenovirus
25 serotype 2 or 5.

In another aspect the invention describes the construction
and use of libraries consisting of distinct parts of
adenovirus serotype 5 in which one or more genes or
30 sequences have been replaced with DNA derived from
alternative human or animal serotypes. This set of
constructs, in total encompassing the complete adenovirus
genome, allows for the construction of unique chimaeric
adenoviruses customized for a certain group of patients or
35 even a single individual.

In all aspects of the invention the chimaeric adenoviruses may, or may not, contain deletions in the E1 region and insertions of heterologous genes linked either or not to a promoter. Furthermore, chimaeric adenoviruses may, or may not, contain deletions in the E3 region and insertions of heterologous genes linked to a promoter. Furthermore, chimaeric adenoviruses may, or may not, contain deletions in the E2 and/ or E4 region and insertions of heterologous genes linked to a promoter. In the latter case E2 and/ or E4 complementing cell lines are required to generate recombinant adenoviruses.

Example 1: Generation of adenovirus serotype 5 genomic plasmid clones

The complete genome of adenovirus serotype 5 has been cloned into various plasmids or cosmids to allow easy modification of parts of the adenovirus serotype 5 genome, while still retaining the capability to produce recombinant virus. For this purpose the following plasmids were generated:

1. pBr/Ad.Bam-rITR (ECACC deposit P97082122)

In order to facilitate blunt end cloning of the ITR sequences, wild-type human adenovirus type 5 (Ad5) DNA was treated with Klenow enzyme in the presence of excess dNTPs. After inactivation of the Klenow enzyme and purification by phenol/chloroform extraction followed by ethanol precipitation, the DNA was digested with BamHI. This DNA preparation was used without further purification in a ligation reaction with pBr322 derived vector DNA prepared as follows: pBr322 DNA was digested with EcoRV and BamHI, dephosphorylated by treatment with TSAP enzyme (Life Technologies) and purified on LMP agarose gel (SeaPlaque GTG). After transformation into competent *E.coli* DH5a (Life Techn.) and analysis of ampiciline resistant colonies, one clone was selected that showed a digestion pattern as

expected for an insert extending from the BamHI site in Ad5 to the right ITR.

Sequence analysis of the cloning border at the right ITR revealed that the most 3' G residue of the ITR was missing, the remainder of the ITR was found to be correct. Said
5 missing G residue is complemented by the other ITR during replication.

2. pBr/Ad.Sal-rITR (ECACC deposit P97082119)

10 pBr/Ad.Bam-rITR was digested with BamHI and Sali. The vector fragment including the adenovirus insert was isolated in LMP agarose (SeaPlaque GTG) and ligated to a 4.8 kb Sali-BamHI fragment obtained from wt Ad5 DNA and purified with the GeneClean II kit (Bio 101, Inc.). One clone was chosen and
15 the integrity of the Ad5 sequences was determined by restriction enzyme analysis. Clone pBr/Ad.Sal-rITR contains adeno type 5 sequences from the Sali site at bp 16746 up to and including the rITR (missing the most 3' G residue).

20 3. pBr/Ad.Cla-Bam (ECACC deposit P97082117)

wt Adeno type 5 DNA was digested with ClaI and BamHI, and the 20.6 kb fragment was isolated from gel by electro-elution. pBr322 was digested with the same enzymes and purified from agarose gel by GeneClean. Both fragments were ligated and
25 transformed into competent DH5a. The resulting clone pBr/Ad.Cla-Bam was analyzed by restriction enzyme digestion and shown to contain an insert with adenovirus sequences from bp 919 to 21566.

30 4. pBr/Ad.AflIII-Bam (ECACC deposit P97082114)

Clone pBr/Ad.Cla-Bam was linearized with EcoRI (in pBr322) and partially digested with AflIII. After heat inactivation of AflIII for 20' at 65°C the fragment ends were filled in with Klenow enzyme. The DNA was then ligated to a blunt double
35 stranded oligo linker containing a PacI site (5'-AATTGCTTAATTAACCGCTTAA-3'). This linker was made by

annealing the following two oligonucleotides: 5'-
AATTGTCTTAATTAACCGC-3' and 5'-AATTGCGGTTAATTAAGAC-3',

5 followed by blunting with Klenow enzyme. After precipitation
of the ligated DNA to change buffer, the ligations were
digested with an excess PacI enzyme to remove concatamers of
the oligo. The 22016 bp partial fragment containing Ad5
sequences from bp 3534 up to 21566 and the vector sequences,
was isolated in LMP agarose (SeaPlaque GTG), religated and
transformed into competent DH5a. One clone that was found to
10 contain the PacI site and that had retained the large adeno
fragment was selected and sequenced at the 5' end to verify
correct insertion of the PacI linker in the (lost) AflII
site.

15 5. pBr/Ad.Bam-rITRpac#2 (ECACC deposit P97082120) and
pBr/Ad.Bam-rITR#8 (ECACC deposit P97082121)

To allow insertion of a PacI site near the ITR of Ad5 in
clone pBr/Ad.Bam-rITR about 190 nucleotides were removed
between the ClaI site in the pBr322 backbone and the start of
20 the ITR sequences. This was done as follows: pBr/Ad.Bam-rITR
was digested with ClaI and treated with nuclease Bal31 for
varying lengths of time (2', 5', 10' and 15'). The extent of
nucleotide removal was followed by separate reactions on
pBr322 DNA (also digested at the ClaI site), using identical
25 buffers and conditions. Bal31 enzyme was inactivated by
incubation at 75°C for 10 minutes, the DNA was precipitated
and resuspended in a smaller volume of TE buffer. To ensure
blunt ends, DNAs were further treated with T4 DNA polymerase
in the presence of excess dNTPs. After digestion of the
30 (control) pBr322 DNA with SalI, satisfactory degradation
(~150 bp) was observed in the samples treated for 10' or 15'.
The 10' or 15' treated pBr/Ad.Bam-rITR samples were then
ligated to the above described blunted PacI linkers (See
pBr/Ad.AflII-Bam). Ligations were purified by precipitation,
35 digested with excess PacI and separated from the linkers on
an LMP agarose gel. After religation, DNAs were transformed

into competent DH5a and colonies analyzed. Ten clones were selected that showed a deletion of approximately the desired length and these were further analyzed by T-track sequencing (T7 sequencing kit, Pharmacia Biotech). Two clones were found with the PacI linker inserted just downstream of the rITR. After digestion with PacI, clone #2 has 28 bp and clone #8 has 27 bp attached to the ITR.

pWE/Ad.AflIII-rITR (ECACC deposit P97082116)

10 Cosmid vector pWE15 (Clontech) was used to clone larger Ad5 inserts. First, a linker containing a unique PacI site was inserted in the EcoRI sites of pWE15 creating pWE.pac. To this end, the double stranded PacI oligo as described for pBr/Ad.AflIII-BamHI was used but now with its EcoRI protruding ends. The following fragments were then isolated by electro-
15 elution from agarose gel: pWE.pac digested with PacI, pBr/AflIII-Bam digested with PacI and BamHI and pBr/Ad.Bam-rITR#2 digested with BamHI and PacI. These fragments were ligated together and packaged using 1 phage packaging
20 extracts (Stratagene) according to the manufacturer's protocol. After infection into host bacteria, colonies were grown on plates and analyzed for presence of the complete insert. pWE/Ad.AflIII-rITR contains all adenovirus type 5 sequences from bp 3534 (AflIII site) up to and including the
25 right ITR (missing the most 3' G residue).

pBr/Ad.lITR-Sal(9.4) (ECACC deposit P97082115)

Adeno 5 wt DNA was treated with Klenow enzyme in the presence of excess dNTPs and subsequently digested with SalI. Two of
30 the resulting fragments, designated left ITR-Sal(9.4) and Sal(16.7)-right ITR, respectively, were isolated in LMP agarose (Seaplaque GTG). pBr322 DNA was digested with EcoRV and SalI and treated with phosphatase (Life Technologies). The vector fragment was isolated using the GeneClean method
35 (BIO 101, Inc.) and ligated to the Ad5 SalI fragments. Only the ligation with the 9.4 kb fragment gave colonies with an

insert. After analysis and sequencing of the cloning border a clone was chosen that contained the full ITR sequence and extended to the SallI site at bp 9462.

5 pBr/Ad.lITR-Sal(16.7) (ECACC deposit P97082118)
pBr/Ad.lITR-Sal(9.4) is digested with SallI and dephosphorylated (TSAP, Life Technologies). To extend this clone upto the third SallI site in Ad5, pBr/Ad.Cla-Bam was linearized with BamHI and partially digested with SallI. A 7.3
10 kb SallI fragment containing adenovirus sequences from 9462-16746 was isolated in LMP agarose gel and ligated to the SallI-digested pBr/Ad.lITR-Sal(9.4) vector fragment.

pWE/Ad.AflIII-EcoRI

15 pWE.pac was digested with ClaI and 5' protruding ends were filled using Klenow enzyme. The DNA was then digested with PacI and isolated from agarose gel. pWE/AflIII-rITR was digested with EcoRI and after treatment with Klenow enzyme digested with PacI. The large 24 kb fragment containing the
20 adenoviral sequences was isolated from agarose gel and ligated to the ClaI-digested and blunted pWE.pac vector using the Ligation Expresstm kit from Clontech. After transformation of Ultracompetent XL10-Gold cells from Stratagene, clones were identified that contained the
25 expected insert. pWE/AflIII-EcoRI contains Ad5 sequences from bp 3534-27336.

Construction of new adapter plasmids

The absence of sequence overlap between the recombinant
30 adenovirus and E1 sequences in the packaging cell line is essential for safe, RCA-free generation and propagation of new recombinant viruses. The adapter plasmid pMLPI.TK (figure. 1) is an example of an adapter plasmid designed for use according to the invention in combination with the
35 improved packaging cell lines of the invention. This plasmid was used as the starting material to make a new vector in

which nucleic acid molecules comprising specific promoter and gene sequences can be easily exchanged.

First, a PCR fragment was generated from pZip Δ Mo+PyF101(N⁻) template DNA (described in PCT/NL96/00195) with the following primers: LTR-1: 5'-CTG TAC GTA CCA GTG CAC TGG CCT AGG CAT GGA AAA ATA CAT AAC TG-3' and LTR-2: 5'-GCG GAT CCT TCG AAC CAT GGT AAG CTT GGT ACC GCT AGC GTT AAC CGG GCG ACT CAG TCA ATC G-3'. Pwo DNA polymerase (Boehringer Mannheim) was used according to manufacturers protocol with the following temperature cycles: once 5' at 95°C; 3' at 55°C; and 1' at 72°C, and 30 cycles of 1' at 95°C, 1' at 60°C, 1' at 72°C, followed by once 10' at 72°C. The PCR product was then digested with BamHI and ligated into pMLP10 (Levrero et al., 1991) vector digested with PvuII and BamHI, thereby generating vector pLTR10. This vector contains adenoviral sequences from bp 1 up to bp 454 followed by a promoter consisting of a part of the Mo-MuLV LTR having its wild-type enhancer sequences replaced by the enhancer from a mutant polyoma virus (PyF101). The promoter fragment was designated L420. Next, the coding region of the murine HSA gene was inserted. pLTR10 was digested with BstBI followed by Klenow treatment and digestion with NcoI. The HSA gene was obtained by PCR amplification on pUC18-HSA (Kay et al., 1990) using the following primers: HSA1, 5'-GCG CCA CCA TGG GCA GAG CGA TGG TGG C-3' and HSA2, 5'-GTT AGA TCT AAG CTT GTC GAC ATC GAT CTA CTA ACA GTA GAG ATG TAG AA-3'. The 269 bp amplified fragment was subcloned in a shuttle vector using the NcoI and BglIII sites. Sequencing confirmed incorporation of the correct coding sequence of the HSA gene, but with an extra TAG insertion directly following the TAG stop codon. The coding region of the HSA gene, including the TAG duplication was then excised as a NcoI (sticky)-SalI (blunt) fragment and cloned into the 3.5 kb NcoI(sticky)/BstBI(blunt) fragment from pLTR10, resulting in pLTR-HSA10.

Finally, pLTR-HSA10 was digested with EcoRI and BamHI after which the fragment containing the left ITR, packaging signal,

L420 promoter and HSA gene was inserted into vector pMLPI.TK digested with the same enzymes and thereby replacing the promoter and gene sequences. This resulted in the new adapter plasmid pAd/L420-HSA (figure. 2) that contains convenient
5 recognition sites for various restriction enzymes around the promoter and gene sequences. SnaBI and AvrII can be combined with HpaI, NheI, KpnI, HindIII to exchange promoter sequences, while the latter sites can be combined with the
10 ClaI or BamHI sites 3' from HSA coding region to replace genes in this construct.

Another adapter plasmid that was designed to allow easy exchange of nucleic acid molecules was made by replacing the promoter, gene and poly A sequences in pAd/L420-HSA with the
15 CMV promoter, a multiple cloning site, an intron and a poly-A signal. For this purpose, pAd/L420-HSA was digested with AvrII and BglII followed by treatment with Klenow to obtain blunt ends. The 5.1 kb fragment with pBr322 vector and
adenoviral sequences was isolated and ligated to a blunt 1570 bp fragment from pcDNA1/amp (Invitrogen) obtained by
20 digestion with HhaI and AvrII followed by treatment with T4 DNA polymerase. This adapter plasmid was named pCLIP.Luc (figure. 3).

Generation of recombinant adenoviruses

25

To generate E1 deleted recombinant adenoviruses with the new plasmid-based system, the following constructs are prepared:

- a) An adapter construct containing the expression cassette with the gene of interest linearized with a restriction
30 enzyme that cuts at the 3' side of the overlapping adenoviral genome fragment, preferably not containing any pBr322 vector sequences, and
- b) A complementing adenoviral genome construct pWE/Ad.AflIII-rITR digested with PacI.

35 These two DNA molecules are further purified by phenol/chloroform extraction and EtOH precipitation. Co-transfection

of these plasmids into an adenovirus packaging cell line, preferably a cell line according to the invention, generates recombinant replication deficient adenoviruses by a one-step homologous recombination between the adapter and the complementing construct (figure. 4).

Alternatively, in stead of pWE/Ad.AflIII-rITR other fragments can be used, e.g., pBr/Ad.Cla-Bam digested with EcoRI and BamHI or pBr/Ad.AflIII-BamHI digested with PacI and BamHI can be combined with pBr/Ad.Sal-rITR digested with SalI. In this case, three plasmids are combined and two homologous recombinations are needed to obtain a recombinant adenovirus (figure. 5). It is to be understood that those skilled in the art may use other combinations of adapter and complementing plasmids without departing from the present invention.

A general protocol as outlined below and meant as a non-limiting example of the present invention has been performed to produce several recombinant adenoviruses using various adapter plasmids and the Ad.AflIII-rITR fragment. Adenovirus packaging cells (PER.C6) were seeded in $\sim 25 \text{ cm}^2$ flasks and the next day when they were at $\sim 80\%$ confluency, transfected with a mixture of DNA and lipofectamine agent (Life Techn.) as described by the manufacturer. Routinely, $40 \mu\text{l}$ lipofectamine, $4 \mu\text{g}$ adapter plasmid and $4 \mu\text{g}$ of the complementing adenovirus genome fragment AflIII- rITR (or $2 \mu\text{g}$ of all three plasmids for the double homologous recombination) are used. Under these conditions transient transfection efficiencies of $\sim 50\%$ (48 hrs post transfection) are obtained as determined with control transfections using a pAd/CMV-LacZ adapter. Two days later, cells are passaged to $\sim 80 \text{ cm}^2$ flasks and further cultured. Approximately five (for the single homologous recombination) to eleven days (for the double homologous recombination) later a cytopathogenic effect (CPE) is seen, indicating that functional adenovirus has formed. Cells and medium are harvested upon full CPE and recombinant virus is released by freeze-thawing. An extra

amplification step in an 80 cm² flask is routinely performed to increase the yield since at the initial stage the titers are found to be variable despite the occurrence of full CPE. After amplification, viruses are harvested and plaque
5 purified on PER.C6 cells. Individual plaques are tested for viruses with active transgenes.

Besides replacements in the E1 region it is possible to delete or replace (part of) the E3 region in the adenovirus
10 because E3 functions are not necessary for the replication, packaging and infection of the (recombinant) virus. This creates the opportunity to use a larger insert or to insert more than one gene without exceeding the maximum package size (approximately 105% of wt genome length). This can be done,
15 e.g., by deleting part of the E3 region in the pBr/Ad.Bam-rITR clone by digestion with XbaI and religation. This removes Ad5 wt sequences 28592-30470 including all known E3 coding regions. Another example is the precise replacement of the coding region of gp19K in the E3 region with a polylinker
20 allowing insertion of new sequences. This, 1) leaves all other coding regions intact and 2) obviates the need for a heterologous promoter since the transgene is driven by the E3 promoter and pA sequences, leaving more space for coding sequences.

25 To this end, the 2.7 kb EcoRI fragment from wt Ad5 containing the 5' part of the E3 region was cloned into the EcoRI site of pBluescript (KS⁻) (Stratagene). Next, the HindIII site in the polylinker was removed by digestion with EcoRV and HincII and subsequent religation. The resulting clone pBS.Eco-
30 Eco/ad5DHIII was used to delete the gp19K coding region. Primers 1 (5'-GGG TAT TAG GCC AA AGG CGC A-3') and 2 (5'-GAT CCC ATG GAA GCT TGG GTG GCG ACC CCA GCG-3') were used to amplify a sequence from pBS.Eco-Eco/Ad5DHIII corresponding to sequences 28511 to 28734 in wt Ad5 DNA. Primers 3 (5'-GAT CCC
35 ATG GGG ATC CTT TAC TAA GTT ACA AAG CTA-3') and 4 (5'-GTC GCT GTA GTT GGA CTG G-3') were used on the same DNA to amplify

Ad5 sequences from 29217 to 29476. The two resulting PCR fragments were ligated together by virtue of the new introduced NcoI site and subsequently digested with XbaI and MunI. This fragment was then ligated into the pBS.Eco-Eco/ad5
5 Δ HIII vector that was digested with XbaI (partially) and MunI generating pBS.Eco-Eco/ad5 Δ HIII. Δ gpl9K. To allow insertion of foreign genes into the HindIII and BamHI site, an XbaI deletion was made in pBS.Eco-Eco/ad5 Δ HIII. Δ gpl9K to remove the BamHI site in the Bluescript polylinker. The resulting
10 plasmid pBS.Eco-Eco/ad5 Δ HIII Δ gpl9K Δ XbaI, contains unique HindIII and BamHI sites corresponding to sequences 28733 (HindIII) and 29218 (BamHI) in Ad5. After introduction of a foreign gene into these sites, either the deleted XbaI
15 fragment is re-introduced, or the insert is recloned into pBS.Eco-Eco/ad5 Δ HIII. Δ gpl9K using HindIII and for example MunI. Using this procedure, we have generated plasmids expressing HSV-TK, hIL-1a, rat IL-3, luciferase or LacZ. The unique SrfI and NotI sites in the pBS.Eco-Eco/ad5 Δ HIII. Δ gpl9K
20 plasmid (with or without inserted gene of interest) are used to transfer the region comprising the gene of interest into the corresponding region of pBr/Ad.Bam-rITR, yielding construct pBr/Ad.Bam-rITR Δ gpl9K (with or without inserted gene of interest). This construct is used as described *supra*
25 to produce recombinant adenoviruses. In the viral context, expression of inserted genes is driven by the adenovirus E3 promoter.

Recombinant viruses that are both E1 and E3 deleted are generated by a double homologous recombination procedure as described above for E1-replacement vectors using a plasmid-
30 based system consisting of:

- a) an adapter plasmid for E1 replacement according to the invention, with or without insertion of a first gene of interest,
- b) the pWE/Ad.AflIII-EcoRI fragment, and
- 35 c) the pBr/Ad.Bam-rITR Δ gpl9K plasmid with or without insertion of a second gene of interest.

In addition to manipulations in the E3 region, changes of (parts of) the E4 region can be accomplished easily in pBr/Ad.Bam-rITR. Generation and propagation of such a virus, however, in some cases demands complementation *in trans*.

5

Example 2: Generation of adenovirus serotype 5 based viruses with chimaeric fiber proteins

The method described *infra* to generate recombinant adenoviruses by co-transfection of two, or more separate cloned adenoviral sequences. These cloned adenoviral sequences were subsequently used to remove specific adenovirus serotype 5 sequences in order to generate template clones which allow for the easy introduction of DNA sequences derived from other adenovirus serotypes. As an example of these template clones, the construction of plasmids enabling swapping of DNA encoding for fiber protein is given below.

Generation of adenovirus template clones lacking DNA encoding fiber

The fiber coding sequence of adenovirus serotype 5 is located between nucleotides 31042 and 32787. To remove the adenovirus serotype 5 DNA encoding fiber we started with construct pBr/Ad.Bam-rITR. First a NdeI site was removed from this construct. For this purpose, pBr322 plasmid DNA was digested with NdeI after which protruding ends were filled using Klenow enzyme. This pBr322 plasmid was then re-ligated, digested with NdeI and transformed into *E.coli* DH5 α . The obtained pBr/ Δ NdeI plasmid was digested with ScaI and SalI and the resulting 3198 bp vector fragment was ligated to the 15349 bp ScaI-SalI fragment derived from pBr/Ad.BamrITR, resulting in plasmid pBr/Ad.Bam-rITR Δ NdeI which hence contained a unique NdeI site. Next a PCR was performed with oligonucleotides NY-up: 5'- CGA CAT ATG TAG ATG CAT TAG TTT
35 GTG TTA TGT TTC AAC GTG-3'

And NY-down:5'-GGA GAC CAC TGC CAT GTT-3' (figure 6). During amplification, both a NdeI (bold face) and a NsiI restriction site (underlined) were introduced to facilitate cloning of the amplified fiber DNAs. Amplification consisted of 25
5 cycles of each 45 sec. at 94°C, 1 min. at 60°C, and 45 sec. at 72°C. The PCR reaction contained 25 pmol of oligonucleotides NY-up or NY-down, 2mM dNTP, PCR buffer with 1.5 mM MgCl₂, and 1 unit of Elongase heat stable polymerase (Gibco, The Netherlands). One-tenth of the PCR product was
10 run on an agarose gel which demonstrated that the expected DNA fragment of ± 2200 bp was amplified. This PCR fragment was subsequently purified using GeneClean kit system (Bio101 Inc.). Then, both the construct pBr/Ad.Bam-rITRANdeI as well as the PCR product were digested with restriction enzymes
15 NdeI and SbfI. The PCR fragment was subsequently cloned using T4 ligase enzyme into the NdeI and SbfI digested pBr/Ad.Bam-rITRANdeI, generating pBr/Ad.BamRAFib. This plasmid allows insertion of any PCR amplified fiber sequence through the unique NdeI and NsiI sites that are inserted in place of the
20 removed fiber sequence. Viruses can be generated by a double homologous recombination in packaging cells described *infra* using an adapter plasmid, construct pBr/Ad.AflIII-EcoRI digested with PacI and EcoRI and a pBr/Ad.BamRAFib construct in which heterologous fiber sequences have been inserted. To
25 increase the efficiency of virus generation, the construct pBr/Ad.BamRAFib was modified to generate a PacI site flanking the right ITR. Hereto, pBr/Ad.BamRAFib was digested with AvrII and the 5 kb adeno fragment was isolated and introduced into the vector pBr/Ad.Bam-rITR.pac#8 replacing the
30 corresponding AvrII fragment. The resulting construct was named pBr/Ad.BamRAFib.pac. Once a heterologous fiber sequence is introduced in pBr/Ad.BamRAFib.pac, the fiber modified right hand adenovirus clone may be introduced into a large cosmid clone as described for pWE/Ad.AflIII-rITR in example 1.
35 Such a large cosmid clone allows generation of adenovirus by

only one homologous recombination making the process extremely efficient.

Amplification of fiber sequences from adenovirus serotypes

5 To enable amplification of the DNAs encoding fiber protein derived from alternative serotypes degenerate oligonucleotides were synthesized. For this purpose, first known DNA sequences encoding fiber protein of alternative serotypes were aligned to identify conserved regions in both
10 the tail-region as well as the knob-region of the fiber protein. From the alignment, which contained the nucleotide sequence of 19 different serotypes representing all 6 subgroups, (degenerate) oligonucleotides were synthesized (see table 3). Also shown in table 3 is the combination of
15 oligonucleotides used to amplify the DNA encoding fiber protein of a specific serotype. The amplification reaction (50 μ l) contained 2 mM dNTPs, 25 pmol of each oligonucleotide, standard 1x PCR buffer, 1,5 mM MgCl₂, and 1 Unit Pwo heat stable polymerase (Boehringer) per reaction.
20 The cycler program contained 20 cycles, each consisting of 30 sec. 94°C, 60 sec. 60-64°C, and 120 sec. at 72°C. One-tenth of the PCR product was run on an agarose gel which demonstrated that a DNA fragment was amplified. Of each different template, two independent PCR reactions were performed after
25 which the independent PCR fragments obtained were sequenced to determine the nucleotide sequence. From 11 different serotypes, the nucleotide sequence could be compared to sequences present in GenBank. Of all other serotypes, the DNA encoding fiber protein was unknown till date and was
30 therefore aligned with known sequences from other subgroup members to determine homology i.e. sequence divergence. Of the 51 human serotypes known to date, all fiber sequences, except for serotypes 1, 6, and 26, have been amplified and sequenced. The protein sequences of the fiber from different
35 adenovirus serotypes is given in figure 7.

Generation of fiber chimaeric adenoviral DNA constructs

All amplified fiber DNAs as well as the vector (pBr/Ad.BamRA Fib) were digested with NdeI and NsiI. The digested DNAs was
5 subsequently run on a agarose gel after which the fragments were isolated from the gel and purified using the GeneClean kit (Bio101 Inc). The PCR fragments were then cloned into the NdeI and NsiI sites of pBr/AdBamRAFib, thus generating pBr/AdBamRFibXX (where XX stands for the serotype number of
10 which the fiber DNA was isolated). So far the fiber sequence of serotypes 5/ 7/ 8/ 9/ 10/ 11/ 12/ 13/ 14/ 16/ 17/ 19/ 21/ 24/ 27/ 28/ 29/ 30/ 32/ 33/ 34/ 35/ 36/ 37/ 38/ 40-S/ 40-L/ 41-S/ 42/45/ 47/ 49/ 51 have been cloned into pBr/AdBamRFibXX. From pBr/AdBamRFibXX (where XX is 5/ 8/ 9/
15 10/ 11/ 13/ 16/ 17/ 24/ 27/ 30/ 32/ 33/ 34/ 35/ 38/ 40-S/ 40-L/ 45/ 47/ 49/ 51) an 6 kb AvrII fragment encompassing the fiber sequence was isolated via gelelectrophoresis and GeneClean. This AvrII fragment was subsequently cloned in plasmid pBr/Ad.Bam-rITR.pac (see example 1) which was
20 digested to completion with AvrII and dephosphorylated as described previously, leading to the generation of the plasmid pBr/Ad.Bam-rITR.pac.fibXX. This plasmid was subsequently used to generate a cosmid clone with a modified fiber using the constructs pWE.pac, pBr/AflII-Bam and
25 pBr/Ad.Bam-rITR.pac.fibXX. This cosmid cloning resulted in the formation of construct pWE/Ad.AflII-rITR/FibXX (where XX stands for the serotype number of which the fiber DNA was isolated).

30 Generation of pAd5/L420.HSA, pAd5/Clip and pAd5/Clipsal

pMLPI.TK was used to make a new vector in which nucleic acid molecules comprising specific promoter and gene sequences can be easily exchanged.

First, a PCR fragment was generated from pZip Δ Mo+PyF101(N⁻)
35 template DNA (described in PCT/NL96/00195) with the following primers: LTR-1: 5'-CTG TAC GTA CCA GTG CAC TGG CCT AGG CAT

GGA AAA ATA CAT AAC TG-3' and LTR-2: 5'-GCG GAT CCT TCG AAC
CAT GGT AAG CTT GGT ACC GCT AGC GTT AAC CGG GCG ACT CAG TCA
ATC G-3'. Pwo DNA polymerase (Boehringer Mannheim) was used
according to manufacturers protocol with the following
5 temperature cycles: once 5' at 95°C; 3' at 55°C; and 1' at
72°C, and 30 cycles of 1' at 95°C, 1' at 60°C, 1' at 72°C,
followed by once 10' at 72°C. The PCR product was then
digested with BamHI and ligated into pMLP10 (Levrero et al.,
1991; Gene 101, 195-202) digested with PvuII and BamHI,
10 thereby generating vector pLTR10. This vector contains
adenoviral sequences from bp 1 up to bp 454 followed by a
promoter consisting of a part of the Mo-MuLV LTR having its
wild-type enhancer sequences replaced by the enhancer from a
mutant polyoma virus (PyF101). The promoter fragment was
15 designated L420. Sequencing confirmed correct amplification
of the LTR fragment however the most 5' bases in the PCR
fragment were missing so that the PvuII site was not
restored. Next, the coding region of the murine HSA gene was
inserted. pLTR10 was digested with BstBI followed by Klenow
20 treatment and digestion with NcoI. The HSA gene was obtained
by PCR amplification on pUC18-HSA (Kay et al., 1990; J.
Immunol. 145, 1952-1959) using the following primers: HSA1,
5'-GCG CCA CCA TGG GCA GAG CGA TGG TGG C-3' and HSA2, 5'-GTT
AGA TCT AAG CTT GTC GAC ATC GAT CTA CTA ACA GTA GAG ATG TAG
25 AA-3'. The 269 bp amplified fragment was subcloned in a
shuttle vector using the NcoI and BglII sites. Sequencing
confirmed incorporation of the correct coding sequence of the
HSA gene, but with an extra TAG insertion directly following
the TAG stop codon. The coding region of the HSA gene,
30 including the TAG duplication was then excised as a
NcoI(sticky)-SalI(blunt) fragment and cloned into the 3.5 kb
NcoI(sticky)/BstBI(blunt) fragment from pLTR10, resulting in
pLTR-HSA10.
Finally, pLTR-HSA10 was digested with EcoRI and BamHI after
35 which the fragment containing the left ITR, packaging signal,
L420 promoter and HSA gene was inserted into vector pMLPI.TK

digested with the same enzymes and thereby replacing the promoter and gene sequences. This resulted in the new adapter plasmid pAd5/L420-HSA that contains convenient recognition sites for various restriction enzymes around the promoter and gene sequences. *Sna*BI and *Avr*II can be combined with *Hpa*I, *Nhe*I, *Kpn*I, *Hind*III to exchange promoter sequences, while the latter sites can be combined with the *Cla*I or *Bam*HI sites 3' from HSA coding region to replace genes in this construct.

Another adapter plasmid that was designed to allow easy exchange of nucleic acid molecules was made by replacing the promoter, gene and polyA sequences in pAd5/L420-HSA with the CMV promoter, a multiple cloning site, an intron and a polyA signal. For this purpose, pAd5/L420-HSA was digested with *Avr*II and *Bgl*II followed by treatment with Klenow to obtain blunt ends. The 5.1 kb fragment with pBr322 vector and adenoviral sequences was isolated and ligated to a blunt 1570 bp fragment from pcDNA1/amp (Invitrogen) obtained by digestion with *Hha*I and *Avr*II followed by treatment with T4 DNA polymerase. This adapter plasmid was named pAd5/Clip. To enable removal of vector sequences from the adenoviral fragment pAd5/Clip was partially digested with *Eco*RI and the linear fragment was isolated. An oligo of the sequence 5' TTAAGTCGAC-3' was annealed to itself resulting in a linker with a *Sal*I site and *Eco*RI overhang. The linker was ligated to the partially digested pAd5/Clip vector and clones were selected that had the linker inserted in the *Eco*RI site 23 bp upstream of the left adenovirus ITR in pAd5/Clip resulting in pAd5/Clipsal.

30 Generation of pAd5ClipLacZ, pAd5Clip.Luc, pAd5Clip.TK and pAd5Clipsal.Luc

The adapter plasmid pAd5/Clip.LacZ was generated as follows: The *E. coli* LacZ gene was amplified from the plasmid pMLP.nlsLacZ (EP 95-202 213) by PCR with the primers
35 5'GGGGTGGCCAGGGTACCTCTAGGCTTTTGCAA and
5'GGGGGGATCCATAACAAGTTCAGAATCC. The PCR reaction was

performed Ex Taq (Takara) according to the suppliers protocol at the following amplification program: 5 minutes 94°C, 1 cycle; 45 seconds 94°C and 30 seconds 60°C and 2 minutes 72°C, 5 cycles; 45 seconds 94°C and 30 seconds 65°C and 2 minutes 72°C, 25 cycles; 10 minutes 72; 45 seconds 94°C and 30 seconds 60°C and 2 minutes 72°C, 5 cycles, 1 cycle. The PCR product was subsequently digested with KpnI and BamHI and the digested DNA fragment was ligated into KpnI/BamHI digested pcDNA3 (Invitrogen), giving rise to pcDNA3.nlsLacZ. Next, the plasmid pAd5/Clip was digested with SpeI. The large fragment containing part of the 5' part CMV promoter and the adenoviral sequences was isolated. The plasmid pcDNA3.nlsLacZ was digested with SpeI and the fragment containing the 3' part of the CMV promoter and the lacZ gene was isolated. Subsequently, the fragments were ligated, giving rise to pAd/Clip.LacZ. The reconstitution of the CMV promoter was confirmed by restriction digestion.

The adapter plasmid pAd5/Clip.Luc was generated as follows: The plasmid pCMV.Luc (EP 95-202 213) was digested with HindIII and BamHI. The DNA fragment containing the luciferase gene was isolated. The adapter plasmid pAd5/Clip was digested with HindIII and BamHI, and the large fragment was isolated. Next, the isolated DNA fragments were ligated, giving rise to pAd5/Clip.Luc. The adapter pClipsal.Luc was generated in the same way but using the adapter pClipsal digested with HindIII and BamHI as vector fragment. Likewise, the TK containing HindIII-BamHI fragment from pCMV.TK (EP 95-202 213) was inserted in pClipsal to generate pAd5/Clip.TK. The presence of the SalI site just upstream of the left ITR enables liberation of vector sequences from the adeno insert. Removal of these vector sequences enhances frequency of vector generation during homologous recombination in PER.C6.

Generation of recombinant adenovirus chimaeric for fiber protein

To generate recombinant Ad 5 virus carrying the fiber of serotype 12, 16, 28, 40-L, 51, and 5, three constructs, pCLIP.Luc, pWE/AdAflIII-Eco and pBr/AdBamrITR.pac/fibXX (XX = 5 12, 16, 28, 40-L, 51, and 5) were transfected into adenovirus producer cells. To generate recombinant Ad 5 virus carrying the fiber of 5/ 7/ 8/ 9/ 10/ 11/ 12/ 13/ 14/ 16/ 17/ 19/ 21/ 24/ 27/ 28/ 29/ 30/ 32/ 33/ 34/ 35/ 36/ 37/ 38/ 40-S/ 40-L/ 10 41-S/ 42/45/ 47/ 49/ 51, two constructs pCLIP.Luc and pWE/Ad.AflIII-rITR/FibXX were transfected into adenovirus producer cells.

For transfection, 2 µg of pCLIP.Luc, and 4 µg of both pWE/AdAflIII-Eco and pBr/AdBamrITR.pac/fibXX (or in case of 15 cosmids: 4 µg of pCLIP.Luc plus 4 µg of pWE/Ad.AflIII-rITR/FibXX) were diluted in serum free DMEM to 100 µl total volume. To this DNA suspension 100 µl 1x diluted lipofectamine (Gibco) was added. After 30 minutes at room temperature the DNA-lipofectamine complex solution was added 20 to 2.5 ml of serum-free DMEM which was subsequently added to a T25 cm² tissue culture flask. This flask contained 2x10⁶ PER.C6 cells that were seeded 24-hours prior to transfection. Two hours later, the DNA-lipofectamine complex containing medium was diluted once by the addition of 2.4 ml DMEM 25 supplemented with 20% fetal calf serum. Again 24 hours later the medium was replaced by fresh DMEM supplemented with 10% fetal calf serum. Cells were cultured for 6-8 days, subsequently harvested, and freeze/thawed 3 times. Cellular debris was removed by centrifugation for 5 minutes at 3000 30 rpm room temperature. Of the supernatant (12.5 ml) 3-5 ml was used to infect again infect PER.C6 cells (T80 cm² tissue culture flasks). This re-infection results in full cytopathogenic effect (CPE) after 5-6 days after which the adenovirus is harvested as described above. With the 35 generated virus batch two assays were routinely performed. 1)

20 µl virus supernatant, diluted 10-fold by the addition of 1980 µl DMEM was used to infect A549 cells that were seeded 24-hours prior to infection at a concentration of 10^5 cells per well of 6-well plates. Forty-eight hours later protein lysates were prepared that were subsequently used to measure marker gene expression (luciferase activity). 2) 20 µl virus supernatant is used to determine the virus titer on human 911 cells. For this purpose, 911 cells are seeded at a concentration of 4×10^4 cells per well in 96-well plates. Three to four hours after seeding, the medium was replaced by adenovirus supernatant (dilution range: 2 µl - 5×10^{-9} µl). The virus titers of the chimaeric fiber adenovirus serotype 5 always exceeded 1×10^8 infectious units per ml.

Example 3: Production, purification, and titration of chimaeric adenoviruses

Of the supernatant obtained from transfected PER.C6 cells typically 10 ml was used to inoculate a 1 liter fermentor which contained 1 - 1.5×10^6 cells/ml PER.C6 that were specifically adapted to grow in suspension. Three days after inoculation, the cells were harvested and pelleted by centrifugating for 10 min at 1750 rpm at room temperature. The chimaeric adenoviruses present in the pelleted cells were subsequently extracted and purified using the following downstream processing protocol. The pellet was dissolved in 50 ml 10 mM NaPO_4^- and frozen at -20°C . After thawing at 37°C , 5.6 ml deoxycholate (5% w/v) was added after which the solution was homogenated. The solution was subsequently incubated for 15 minutes at 37°C to crack the cells. After homogenizing the solution, 1875 µl (1M) MgCl_2^- was added and 5 ml 100% glycerol. After the addition of 375 µl DNase (10 mg/ml) the solution was incubated for 30 minutes at 37°C . Cell debris was removed by centrifugation at 1880xg for 30 minutes at room temperature without the brake on. The

supernatant was subsequently purified from proteins by loading on 10 ml of freon. Upon centrifugation for 15 minutes at 2000 rpm without brake at room temperature three bands were visible of which the upper band represents the adenovirus. This band was isolated by pipetting after which it was loaded on a Tris/HCl (1M) buffered caesium chloride blockgradient (range: 1.2 to 1.4 gr./ml). Upon centrifugation at 21000 rpm for 2.5 hours at 10°C the virus was purified from remaining protein and cell debris since the virus, in contrast to the other components, did not migrate into the 1.4 gr./ ml cesium chloride solution. The virus band was isolated after which a second purification using a Tris/ HCl (1M) buffered continuous gradient of 1.33 gr./ml of cesium chloride is performed. After virus loading on top of this gradient the virus was centrifuged for 17 hours at 55000 rpm at 10°C. Subsequently the virus band was isolated and after the addition of 30 µl of sucrose (50 w/v) excess cesium chloride is removed by three rounds of dialysis, each round comprising of 1 hour. For dialysis the virus is transferred to dialysis slides (Slide-a-lizer, cut off 10000 kDa, Pierce, USA). The buffers used for dialysis are PBS which are supplemented with an increasing concentration of sucrose (round 1 to 3: 30 ml, 60 ml, and 150 ml sucrose (50% w/v)/ 1.5 liter PBS, all supplemented with 7.5 ml 2% (w/v) CaMgCl₂). After dialysis, the virus is removed from the slide-a-lizer after which it is aliquoted in portions of 25 and 100 µl upon which the virus is stored at -85°C.

To determine the number of virusparticles per milliliter, 50 µl of the virus batch is run on an high performance liquid chromatograph columns (HPLC). The adenovirus is bound to the column (anion exchange) after which it is eluted using a NaCl gradient (range 300-600 mM). By determining the area under the viruspeak the number of virus particles can be calculated. To determine the number of infectious units (IU) per ml present in a virus batch, titrations are performed on 911 cells. For this purpose,

4x10⁴ 911 cells are seeded per well of 96-well plates in rows B, D, and F in a total volume of 100 µl per well. Three hours after seeding the cells are attached to the plastic support after which the medium can be removed. To the cells a volume
5 of 200 µl is added, in duplicate, containing different dilutions of virus (range: 10² times diluted to 2x10⁹). By screening for CPE the highest virus dilution which still renders CPE after 14 days is considered to contain at least one infectious unit. Using this observation, together with
10 the calculated amount of virus volume present in these wells renders the number of infectious units per ml of a given virus batch. The production results i.e. virus particles per ml and IU per ml or those chimaeric adenoviruses that were produced so far, are shown in table 4.

15

Example 4: Re-directed infection of chimaeric adenoviruses

To demonstrate re-directed infection *in vitro* of the adenoviruses chimaeric for fiber protein, a panel of human
20 cell lines of different origins was used. This panel includes amongst others human hepatic cells, primary fibroblasts, hemopoietic derived cell lines, primary smooth muscle cells, primary synoviocytes, and primary cells derived from the amniotic fluid such as amniocytes and chorionvilli. These
25 cell types were infected with a panel of chimaeric adenoviruses which differ in the fiber protein. For this purpose target cells are seeded at a concentration of 10⁵ cells per well of 6-well plates in 2 ml Dulbecco's modified Eagle's medium (DMEM, Life Technologies, The Netherlands)
30 supplemented with 10% Fetal calf serum. Twenty-four hours later the medium is replaced by fresh medium containing the different chimaeric adenoviruses at an increasing MOI of 0, 10, 50, 250, 1250, 2500, 5000 (MOI based on virus particles per cell). Approximately 2 hours after the addition of virus
35 the medium containing the virus is discarded, cells are

washed once with PBS, and subsequently 2 ml of fresh medium (not containing virus) is added to each well. Forty-eight hours later cells are harvested, washed and pelleted by centrifugating 5 minutes at 1500 rpm. Cells are subsequently lysed in 0,1 ml lysis buffer (1% Triton-X-100, 15% Glycerol, 2 mM EDTA, 2 mM DTT, and 25 mM MgCl₂ in Tris-phosphate buffer pH 7.8) after which the total protein concentration of the lysate is measured (Biorad, protein standard II). To determine marker gene expression (luciferase activity) 20 µl of the protein sample is mixed with 100 µl of a luciferase substrate (Luciferine, Promega, The Netherlands) and subsequently measured on a Lumat LB 9507 apparatus (EG & G Berthold, The Netherlands). The results of these infection experiments, given as the amount of luciferase activity (RLU) per µg protein, are shown in Table 5. These results clearly demonstrate that alteration of the fiber protein results in alteration of the adenovirus serotype 5 host range.

Example 5: Receptor usage of Fiber chimaeric adenoviruses

To determine what cellular molecules are used by the fiber chimaeric adenoviruses the expression of proteins known to be involved in adenovirus serotype 5 infection i.e. Coxsackie adenovirus receptor (CAR), MHC class I, and integrins ($\alpha\beta 3$, $\alpha\beta 5$) was measured. For this purpose, 1×10^5 target cells were transferred to tubes (4 tubes per cell type) designed for flow cytometry. Cells were washed once with PBS/ 0.5% BSA after which the cells were pelleted by centrifugation for 5 minutes at 1750 rpm at room temperature. Subsequently, 10 µl of a 100 times diluted $\alpha\beta 3$ antibody (Mab 1961, Brunswick chemie, Amsterdam, The Netherlands), a 100 times diluted antibody $\alpha\beta 5$ (antibody (Mab 1976, Brunswick chemie, Amsterdam, The Netherlands), or 2000 times diluted CAR antibody (a kind gift of Dr. Bergelson, Harvard Medical School, Boston, USA (Hsu et al)) was added to the cell pellet

after which the cells were incubated for 30 minutes at 4°C in a dark environment. After this incubation, cells were washed twice with PBS/0.5% BSA and again pelleted by centrifugation for 5 minutes at 1750 rpm room temperature. To label the cells, 10 µl of rat anti mouse IgG1 labeled with phycoerythrine (PE) was added to the cell pellet upon which the cells were again incubated for 30 minutes at 4°C in a dark environment. Finally the cells were washed twice with PBS/0.5% BSA and analyzed on a flow cytometer. The results of these experiments are shown in table 6. Also, in table 6 the infection efficiency of an adenovirus from subgroup A, B, C, D, and F is incorporated. These data clearly show that infection of a subgroup C adenovirus correlates with expression of CAR. The data also demonstrate that the chimaeric adenoviruses carrying a fiber of an adenovirus of subgroup B, D, or F can infect cells that do not express measurable levels of the CAR protein thus being able to infect cells via different (CAR-independent) pathways.

20 **Example 6: Radiolabeling of adenovirus particles**

To enable tracking of infection of the wild type adenovirus serotypes, these viruses were labeled with radioactive I¹²³/I¹²⁵ or with fluorescent probes prior to infection. Using fluorescent microscopy or by measuring radioactivity, the efficiency of infection of different serotypes into particular cell types is determined. To demonstrate re-directed infection in vivo of adenovirus chimaeric for fiber protein, 1x10⁹ infectious particles were injected via the tail vein into CBA/ca mice (2 mice for each chimaeric adenovirus). Detection of adenovirus infection into specific tissues is monitored on two different levels:

1) Binding of chimaeric adenovirus is monitored by radioactive labeling the adenovirus (Eisenlohr et al., 1987; Matlin et al., 1981; Richman et al., 1998). One hour after in vivo systemic delivery via the tail vein mice are sacrificed after which preferred is investigated by measuring radioactivity in

various organs c.g. tissues. 2) Successful infection is monitored by adenovirus gene expression of the marker gene i.e. lacZ or luciferase activity. Four days after administration mice are sacrificed after which organs and tissues are isolated. Samples included liver, spleen, gastrointestinal tract, peripheral blood, bone marrow, aorta, muscle etc. Using this strategy, preferred binding of chimaeric adenovirus towards tissues of interest can be investigated. Moreover, using this strategy, preferred infection of chimaeric adenovirus into specific cells of particular organs can be determined.

80 μCi I^{123} (Cygne BV, The Netherlands) or I^{125} (Amersham) was activated by incubation for six minutes at RT in an Iodogen pre-coated tube (Pierce) in 100 μl iodination buffer (25 mM Tris, pH8, 0.4 M NaCl). The radiolabeling reaction was started by transferring the activated Iodide to an Eppendorf tube containing $1,5 \cdot 10^{10}$ adenovirus particles in 100 μl iodination buffer. The reaction was allowed to proceed for nine minutes at RT, after which incorporated label was separated from free label by gelfiltration, using a Sephadex 25 column (P-10, Pharmacia). To this end, a P-10 column was pre-washed with 10 ml PBS buffer and subsequently loaded with the radiolabeling reaction, supplemented with two ml of iodination buffer. After discarding the first flow-through, the column was eluted with PBS buffer in 0.5 ml steps, and the different fractions were collected in separate tubes. Free label, which is slowed down by the column, was concentrated in fractions 10-16. Radiolabeled virus particles accumulated predominantly in fractions 4, 5 and 6, corresponding to a total eluted volume of 2-3 ml. The radioactivity of these virus-containing fractions was measured and expressed as counts per minute (cpm), resulting in up to $5 \cdot 10^6$ cpm per 10^{10} virus particles.

Several control experiments were conducted to ensure the integrity of the virus particles after the various manipulations. For instance, one reaction was included in

which the virus particles underwent identical treatment but with the omission of radioactive Iodide. Eluted virus particles were subsequently used to infect A549 cells. The amount of infected cells was established by the expression of a visual marker gene such as LacZ. In addition, small aliquots of those eluted fractions that represented radiolabeled adenovirus were used to infect A549 cells to test the expression of the transgene, which was taken as an indication for virus viability of the specific virus batch used.

The radiolabeled virus particles can subsequently be used for various *in vitro* and *in vivo* studies to determine the affinity for different cell types or for different organs. For *in vitro* studies, different cell lines such as for instance HUVEC (human umbilical vein endothelial cells) or SMC (smooth muscle cells) are seeded in 24-well plates in the appropriate culture medium, and infected with radiolabeled adenovirus particles at a multiplicity of infection of 10, 100 and 1000. As a control, cells are incubated with a similar amount of free Iodide. Two hours after infection, cells are extensively washed with PBS buffer, and the remaining radioactivity measured. The amount of radioactivity that remains associated with the cells, corrected for the amount of radioactivity of the control cells incubated with free label, is a direct measure for the amount of virus that is attached to or has penetrated the cells.

For *in vivo* studies, the biodistribution of adenoviruses that differ only in the origin of their fiber proteins was compared. To this end, rats were placed under general anesthetic and 0.1-2 MBq of radiolabeled adenovirus particles was intravenously (iv) administered into the tail vein. As a control, one rat received a comparable dose of free Iodide only. The animals were subsequently placed onto a gamma scanner and scanned for 10 minutes, to localize the source of the gamma radiation and thus to determine the *in vivo*

biodistribution of systemically introduced adenovirus. After one hour, animals were sacrificed and the major organs removed for weighing and for accurate quantification of radioactivity using a scintillation counter. The distribution of radioactivity in various organs after iv is expressed as cpm per gram tissue, and is shown in figure 8.

Example 7: Infection of human primary cells from amniotic fluid.

In Table 5 (example 4) infection results are shown on both amniotic cells and chorionvilli. These cell types are isolated from the amniotic fluid and cultured ex vivo under standard conditions (Roest et al, 1996). Such cells are ideal targets to use for prenatal diagnosis. For instance, in some cases (approximately 50-100 yearly) prenatal diagnosis of muscular dystrophin is impossible using standard techniques such as reverse-transcribed PCR or DNA PCR because the mutations in the dystrophin gene are unknown and the level of dystrophin produced in non-differentiated chorionvilli or amnionvilli cells is very low. In these cases isolation and fast differentiation of predominantly chorionvilli cells is performed. These chorionvilli are subsequently infected with a retrovirus (Roest et al, 1996) or an adenovirus carrying the MyoD cDNA (Roest et al, 1999) which, upon transduction, triggers the chorionvilli to differentiate into striated muscle cells within one week. After complete differentiation these cells can then be used for Western analysis, or immunohistochemistry to determine whether the dystrophin protein is expressed. To date, the infection efficiency of chorionvilli cells has been disappointing with only 2-5% of cells transduced with a retrovirus (Roest et al, 1996). Using a serotype 5 adenovirus to deliver the MyoD cDNA to chorionvilli approximately 10%-20% (Roest et al, 1999) of the cells can be transduced but only when using high multiplicity of infection (MOI) which results in undesired

toxicity and thus cell death. The results in Table 5 clearly demonstrate that the adenovirus serotype 5 is not an ideal candidate for transducing chorionvilli cells since only marginal luciferase activity is measured (75 RLU/ μ g protein) at the highest MOI tested (MOI = 5000 virusparticles per cell). These results are confirmed using flow cytometry for the presence of the Coxsackie adenovirus receptor (CAR) and integrins which demonstrates that the receptors for adenovirus serotype 5 are only marginally present on chorionvilli (Table 6). Surprisingly, the adenovirus serotype 5 based vector containing a fiber of either subgroup B (fiber 16 and/or 51) or subgroup F (fiber 40-L) both transduce the chorionvilli with high efficiency. The vector which does best, based on luciferase activity is the adenovirus 5 with fiber 40-L which results in 1,688,028 relative light units per μ g of protein, >20,000 fold increased transgene expression as compared to adenovirus serotype 5. This vector can thus be used to transduce cells present in the amniotic fluid to allow fast differentiation for purposes described above, for inhibiting gene expression during prenatal development, or to transfer and express nucleic acid of interest to the amniotic fluid.

Example 8: Generation of adenovirus serotype 5 based viruses with chimaeric hexon protein.

The method described *infra* to generate recombinant adenoviruses by co-transfection of two, or more separate cloned adenovirus sequences. These cloned adenoviral sequences were subsequently used to remove specific adenovirus serotype 5 sequences in order to generate template clones which allow for the easy introduction of DNA sequences derived from other adenovirus serotypes. As an example of these template clones, the construction of

plasmids enabling swapping of DNA encoding for hexon protein is given.

Generation of adenovirus template clones lacking DNA encoding for hexon

5 Hexon coding sequences of adenovirus serotype 5 are located between nucleotides 18841 and 21697. To facilitate easy exchange of hexon coding sequences from alternative adenovirus serotypes into the adenovirus serotype 5 backbone, first a shuttle vector was generated. This subclone, coded
10 pBr/Ad.Eco-PmeI, was generated by first digesting plasmid pBr322 with EcoRI and EcoRV and inserting the 14 kb PmeI-EcoRI fragment from pWE/Ad.AflIII-Eco. In this shuttle vector a deletion was made of a 1430 bp SanDI fragment by digestion
15 with SanDI and religation to give pBr/Ad.Eco-PmeI Δ SanDI. The removed fragment contains unique SpeI and MunI sites. From pBr/Ad.Eco-PmeI Δ SanDI the adenovirus serotype 5 DNA encoding hexon was deleted. Hereto, the hexon flanking sequences were PCR amplified and linked together thereby generating unique
20 restriction sites replacing the hexon coding region. For these PCR reactions four different oligonucleotides were required: Δ hex1- Δ hex4. Δ hex1: 5'- CCT GGT GCT GCC AAC AGC-3' Δ hex2: 5'- CCG **GAT CCA** CTA GTG GAA AGC GGG CGC GCG-3' Δ hex3: 5'- CCG **GAT CCA** ATT GAG AAG CAA GCA ACA TCA ACA AC-3' Δ hex4: 5'- GAG AAG GGC ATG GAG GCT G-3' (See figure 9).
25 The amplified DNA product of \pm 1100 bp obtained with oligonucleotides Δ hex1 and Δ hex2 was digested with BamHI and FseI. The amplified DNA product of \pm 1600 bp obtained with oligonucleotides Δ hex3 and Δ hex4 was digested with BamHI and
30 SbfI. These digested PCR fragments were subsequently purified from agarose gel and in a tri-part ligation reaction using T4 ligase enzyme linked to pBr/Ad.Eco-PmeI Δ SanDI digested with FseI and SbfI. The resulting construct was coded pBr/Ad.Eco-PmeI Δ Hexon. This construct was sequenced in part to confirm
35 the correct nucleotide sequence and the presence of unique restriction sites MunI and SpeI.

Amplification of hexon sequences from adenovirus serotypes

To enable amplification of the DNAs encoding hexon protein derived from alternative serotypes degenerate oligonucleotides were synthesized. For this purpose, first known DNA sequences encoding for hexon protein of alternative serotypes were aligned to identify conserved regions in both the N-terminus as well as the C-terminus of the Hexon protein. From the alignment, which contained the nucleotide sequence of 9 different serotypes representing 5 of the 6 known subgroups, (degenerate) oligonucleotides were synthesized. These oligonucleotides were coded HEX-up (5'- GG ACGTGT AAG ATG GCY ACC CCH TCG ATG MTG- 3') and HEX-down (5'- CCA TCG ATG GTT ATG TKG TKG CGT TRC CGG C -3'). The amplification reaction (50 µl) contained 2 mM dNTPs, 25 pmol of each oligonucleotide, standard 1x PCR buffer, 1,5 mM MgCl₂, and 1 Unit Pwo heat stable polymerase (Boehringer) per reaction. The cycler program contained 20 cycles, each consisting of 30 sec. 94°C, 60 sec. 60-64°C, and 120 sec. At 72°C. One-tenth of the PCR product was run on an agarose gel which demonstrated that a DNA fragment was amplified. Of each different template, two independent PCR reactions were performed after which the independent PCR fragments obtained were sequenced to determine the nucleotide sequence. From 9 different serotypes, the nucleotide sequence could be compared to sequences present in GenBank. Of all other serotypes, the nucleotide sequence encoding the Hexon protein is unknown. So far, of each serotype, except for serotypes 1, 8, 13, and 18, the hexon sequence has been PCR amplified. The protein sequence of the hexon of serotypes 34, 35, 36, and 41 is given in figure 10.

Generation of Hexon chimaeric adenoviral DNA constructs

All amplified hexon DNAs as well as the vector (pBr/Ad.Eco-PmeΔHexon) were digested with MunI and SpeI. The digested

DNA was subsequently run on an agarose gel after which the fragments were isolated from the gel and purified using the GeneClean kit (Bio101 Inc). The PCR fragments were then cloned into the *MunI* and *SpeI* sites of pBr/Ad.Eco-Pme Δ Hexon, thus generating pBr/Ad.Eco-Pme Δ HexXX (where XX stands for the serotype number of which the fiber DNA was isolated). So far the hexon sequence of serotypes 2, 3, 4, 5, 7, 9, 10, 11, 14, 15, 16, 19, 20, 22, 23, 25, 26, 27, 28, 29, 30, 31, 32, 33, 34, 35, 36, 37, 38, 40, 41, 42, 43, 46, 47, 48, 49, 50, 51 have been cloned into pBr/Ad.Eco-Pme Δ HexXX. From pBr/Ad.Eco-Pme Δ HexXX (where XX is 20, 25, 26, 28, 30, 34, 35) a 9.6 kb *AscI* fragment encompassing the hexon sequence was isolated via gelelectrophoresis and an agarose protocol (Boehringer Mannheim, The Netherlands). This *AscI* fragment was subsequently cloned in cosmid pWE/Ad.AflIII-rITRsp (see example 1) which was digested to completion with *AscI* and dephosphorylated as described previously. This cosmid cloning resulted in the formation of construct pWE/Ad.AflIII-rITR/HexXX (where XX stands for the serotype number of which the hexon DNA was isolated)

Generation of recombinant adenovirus chimaeric for hexon protein

To generate recombinant Ad 5 virus carrying the hexon of alternative serotypes two constructs, pCLIP.Luc, pWE/Ad.AflIII-rITR/HexXX were transfected into adenovirus producer cells. For transfection, 4 μ g of pCLIP.Luc, and 4 μ g of pWE/Ad.AflIII-rITR/HexXX were diluted in serum free DMEM to 100 μ l total volume. To this DNA suspension 100 μ l 2/3 x diluted lipofectamine (Gibco) was added. After 30 minutes at room temperature the DNA-lipofectamine complex solution was added to 2.5 ml of serum-free DMEM which was subsequently added to a T25 cm² tissue culture flask (cells washed with 5 ml serumfree medium prior to addition of DNA-lipofectamine complex). This flask contained 3 x 10⁶ PER.C6 cells that were

seeded 24-hours prior to transfection. Two hours later, the DNA-lipofectamine complex containing medium was diluted once by the addition of 2.5 ml DMEM supplemented with 20% fetal calf serum. Again 24 hours later the medium was replaced by fresh DMEM supplemented with 10% fetal calf serum. Cells were
5 cultured for 6-8 days, subsequently harvested, and freeze/thawed. Cellular debris was removed by centrifugation for 5 minutes at 3000 rpm room temperature. Of the supernatant (12.5 ml) 3-5 ml was used to again infect PER.C6
10 cells (T80 cm² tissue culture flasks).

Re-directed neutralization towards hexon chimaeric adenovirus

15 To demonstrate an altered immune response towards chimaeric adenoviruses, we first tested 75 sera derived from human patients (25 cancer patients, 50 rheumatoid arthritis patients) for toxicity on human 911 cells. For this purpose, 911 cells were seeded at a concentration of 3×10^4 cells per
20 well in 96-well microtiter plates. Twenty-four hours later the medium of all wells, except for wells A1-H1, A5-H5, and A9-H9, was replaced by 50 μ l DMEM supplemented with 5% fetal calf serum. To wells A1, A2, B1, and B2, 50 μ l patient serum 1 was added. Likewise, To wells C1, C2, D1, and D2, 50 μ l of
25 patient serum 2 was added etc. Subsequently, 50 μ l of wells A2-H2 were transferred to A3-H3 after which 50 μ l of wells A3-H3 was transferred to A4-H4. Thus this test schedule resulted in a serum dilution of 0x, 2x, 4x, and 8x for each patient serum. Identical treatment of wells A5-H5 through A8-
30 H8, and A9-H9 through A12-H12 results in 12 sera tested per 96-well microtiter plate. From 75 human patient sera tested in total, 25 sera with no apparent toxicity on human 911 cells were subsequently tested for the presence of antibodies capable of neutralizing chimaeric adenovirus infection. For
35 this purpose, 96-well microtiter plates were filled with 50 μ

1 DMEM supplemented with 5% fetal calf serum except for wells
A1-H1. To wells A1, A2, B1, and B2, 50 µl patient serum 1 was
added. Likewise, to wells C1, C2, D1, and D2, 50 µl patient
serum 2 was added etc. Subsequently, 50 µl of wells A2-H2
5 were transferred to wells A3-A4 after which 50 µl of A3-H3
was transferred to A4-H4 etc. until A12-H12 (dilution range:
0 - 1/ 2048). From wells A12-H12, 50 µl was discarded. Next,
50 µl of virus was added after which the microtiter plates
were incubated for 1 hour at 37°C. Upon the addition of 50 µl
10 911 cell-suspension (3×10^4 cells/ well) plates were
incubated for 7-9 days after which neutralizing capacity was
scored by the absence, presence, or severity of CPE. As
controls during these experiments absence of serum, absence
of virus, and absence of serum and virus were taken. Based on
15 these experiments several chimaeric viruses are identified
towards which little neutralizing antibodies are generated by
humans. Similar experiments as described above are performed
with wildtype adenovirus serotypes from both human as well as
animals to screen for serotypes which are less prone to
20 neutralization due to the host defense system. These
experiments although similar are developed in such a way that
it allows high throughput screening of many samples at once.
This assay is described below.

25 A high throughput assay for the detection of neutralizing
activity in human serum

To enable screening of a large amount of human sera for the
presence of neutralizing antibodies against all adenovirus
30 serotypes, an automated 96-wells assay was developed.

Human sera

A panel of 100 individuals was selected. Volunteers (50%
male, 50% female) were healthy individuals between 20 and 60
years old with no restriction for race. All volunteers signed

an informed consent form. People professionally involved in adenovirus research were excluded.

Approximately 60 ml blood was drawn in dry tubes. Within two hours after sampling, the blood was centrifuged at 2500 rpm for 10 minutes. Approximately 30 ml serum was transferred to polypropylene tubes and stored frozen at -20°C until further use.

Serum was thawed and heat-inactivated at 56°C for 10 minutes and then aliquotted to prevent repeated cycles of freeze/thawing. Part was used to make five steps of twofold dilutions in medium (DMEM, Gibco BRL) in a quantity enough to fill out approximately 70 96-well plates. Aliquots of undiluted and diluted sera were pipetted in deep well plates (96-well format) and using a programmed platemate dispensed in 100 µl aliquots into 96-well plates. This way the plates were loaded with eight different sera in duplo (100 µl/well) according to the scheme below:

S1/2	S1/4	S1/8	S1/16	S1/32	S5/2	S5/4	S5/8	S5/16	S5/32	-	-
S1/2	S1/4	S1/8	S1/16	S1/32	S5/2	S5/4	S5/8	S5/16	S5/32	-	-
S2/2	S2/4	S2/8	S2/16	S2/32	S6/2	S6/4	S6/8	S6/16	S6/32	-	-
S2/2	S2/4	S2/8	S2/16	S2/32	S6/2	S6/4	S6/8	S6/16	S6/32	-	-
S3/2	S3/4	S3/8	S3/16	S3/32	S7/2	S7/4	S7/8	S7/16	S7/32	-	-
S3/2	S3/4	S3/8	S3/16	S3/32	S7/2	S7/4	S7/8	S7/16	S7/32	-	-
S4/2	S4/4	S3/8	S3/16	S3/32	S8/2	S8/4	S8/8	S8/16	S8/32	-	-
S4/2	S4/4	S3/8	S3/16	S3/32	S8/2	S8/4	S8/8	S8/16	S8/32	-	-

20

Where S1/2 to S8/2 in columns 1 and 6 represent 1x diluted sera and Sx/4, Sx/8, Sx/16 and Sx/32 the twofold serial dilutions. The last plates also contained four wells filled with 100 µl fetal calf serum as a negative control.

25 Plates were kept at -20°C until further use.

Preparation of human adenovirus stocks

Prototypes of all known human adenoviruses were inoculated on T25 flasks seeded with PER.C6 cells (Fallaux et al., 1998) and harvested upon full CPE. After freeze/thawing 1-2 ml of the crude lysates were used to inoculate a T80 flask with PER.C6 cells and virus was harvested at full CPE. The time frame between inoculation and occurrence of CPE as well as the amount of virus needed to re-infect a new culture, differed between serotypes. Adenovirus stocks were prepared by freeze/thawing and used to inoculate 3-4 T175 cm² three-layer flasks with PER.C6 cells. Upon occurrence of CPE, cells were harvested by tapping the flask, pelleted and virus was isolated and purified by a two step CsCl gradient as follows. Cell pellets were dissolved in 50 ml 10 mM NaPO₄ buffer (pH 7.2) and frozen at -20°C. After thawing at 37°C, 5.6 ml sodium deoxycholate (5% w/v) was added. The solution was mixed gently and incubated for 5-15 minutes at 37°C to completely lyse the cells. After homogenizing the solution, 1875 µl 1M MgCl₂ was added. After the addition of 375 µl DNase (10 mg/ml) the solution was incubated for 30 minutes at 37°C. Cell debris was removed by centrifugation at 1880xg for 30 minutes at RT without brake. The supernatant was subsequently purified from proteins by extraction with freon (3x). The cleared supernatant was loaded on a 1M Tris/HCl buffered cesium chloride blockgradient (range: 1.2/1.4 gr/ml) and centrifuged at 21000 rpm for 2.5 hours at 10°C. The virus band is isolated after which a second purification using a 1M Tris/HCl buffered continuous gradient of 1.33 gr/ml of cesium chloride was performed. The virus was then centrifuged for 17 hours at 55000 rpm at 10°C. The virus band is isolated and sucrose (50 % w/v) is added to a final concentration of 1%. Excess cesium chloride is removed by dialysis (three times 1 hr at RT) in dialysis slides (Slide-a-lizer, cut off 10000 kDa, Pierce, USA) against 1.5 ltr PBS supplemented with CaCl₂ (0.9 mM), MgCl₂ (0.5mM) and an increasing concentration of

sucrose (1, 2, 5%). After dialysis, the virus is removed from the slide-a-lizer after which it is aliquoted in portions of 25 and 100 μ l upon which the virus is stored at -85°C .

To determine the number of virus particles per milliliter, 50
5 μ l of the virus batch is run on a high-pressure liquid chromatograph (HPLC) as described by Shabram et al (1997). Viruses were eluted using an NaCl gradient ranging from 0 to 600 mM. As depicted in table I, the NaCl concentration by which the viruses were eluted differed significantly among
10 serotypes.

Most human adenoviruses replicated well on PER.C6 cells with a few exceptions. Adenovirus type 8 and 40 were grown on 911-E4 cells (He et al., 1998). Purified stocks contained between 5×10^{10} and 5×10^{12} virus particles/ml (VP/ml)

15

Titration of purified human adenovirus stocks

Adenoviruses were titrated on PER.C6 cells to determine the amount of virus necessary to obtain full CPE in five days, the length of the neutralization assay. Hereto, 100 μ l medium
20 was dispensed into each well of 96-well plates. 25 μ l of adenovirus stocks prediluted 10^4 , 10^5 , 10^6 or 10^7 times were added to column 2 of a 96-well plate and mixed by pipetting up and down 10 times. Then 25 μ l was brought from column 2 to column 3 and again mixed. This was repeated until column 11
25 after which 25 μ l from column 11 was discarded. This way serial dilutions in steps of 5 were obtained starting off from a prediluted stock. Then 3×10^4 PER.C6 cells were added in a 100 μ l volume and the plates were incubated at 37°C , 5% CO_2 for five or six days. CPE was monitored microscopically.
30 The method of Reed and Muensch was used to calculate the cell culture inhibiting dose 50% (CCID50).

In parallel identical plates were set up that were analyzed using the MTT assay (Promega). In this assay living cells are quantified by colorimetric staining. Hereto, 20 μ l
35 MTT (7.5 mgr/ml in PBS) was added to the wells and incubated at 37°C , 5% CO_2 for two hours. The supernatant was removed

and 100 μ l of a 20:1 isopropanol/triton-X100 solution was added to the wells. The plates were put on a 96-wells shaker for 3-5 minutes to solubilise precipitated staining. Absorbance was measured at 540 nm and at 690 nm (background).

5 By this assay wells with proceeding CPE or full CPE can be distinguished.

Neutralization assay

10 96-well plates with diluted human serum samples were thawed at 37 °C, 5% CO₂. Adenovirus stocks diluted to 200 CCID50 per 50 μ l were prepared and 50 μ l aliquots were added to columns 1-11 of the plates with serum. Plates were incubated for 1 hour at 37°C, 5% CO₂. Then 50 μ l PER.C6 cells at 6x10⁵/ml were
15 dispensed in all wells and incubated for 1 day at 37 °C, 5% CO₂. Supernatant was removed using fresh pipet tips for each row and 200 μ l fresh medium was added to all wells to avoid toxic effects of the serum. Plates were incubated for another 4 days at 37 °C, 5% CO₂. In addition, parallel control plates
20 were set up in duplo with diluted positive control sera generated in rabbits and specific for each serotype to be tested in rows A and B and with negative control serum (FCS) in rows C and D. Also, in each of the rows E-H a titration was performed as described above with steps of five times
25 dilutions starting with 200 CCID50 of each virus to be tested. On day 5 one of the control plates was analyzed microscopically and with the MTT assay. The experimental titer was calculated from the control titration plate observed microscopically. If CPE was found to be complete,
30 i.e. the first dilution in the control titration experiment analyzed by MTT shows clear cell death, all assay plates were processed. If not, the assay was allowed to proceed for one or more days until full CPE was apparent after which all plates were processed. In most cases the assay was terminated
35 at day 5. A serum sample is regarded to be non-neutralizing when at the highest serum concentration a maximum protection is seen of 40% compared to the controls without serum.

Example 9: Generation of Ad5 based viruses with chimaeric penton proteins

5 The method described *infra* to generate recombinant adenoviruses by co-transfection of two, or more separate cloned adenovirus sequences. These cloned adenoviral sequences were subsequently used to remove specific adenovirus serotype 5 sequences in order to generate template
10 clones which allow for the easy introduction of DNA sequences derived from other adenovirus serotypes. As an example of these template clones, the construction of plasmids enabling swapping of DNA encoding for penton protein is given.

15 Generation of adenovirus template clones lacking DNA encoding for penton

First a shuttle vector for penton sequences was made by insertion of the 7.2 kb *NheI*-*EcoRV* fragment from construct
20 pWE/Ad.AflII-*EcoRI* (described in example 1) into pBr322 digested with the same enzymes. The resulting vector was named pBr/XN. From this plasmid Ad5 penton sequences were deleted and replaced by unique restriction sites that are then used to introduce new penton sequences from other
25 serotypes. Hereto, the left flanking sequences of penton in pBr/XN were PCR amplified using the following primers:

DP5-F: 5'- CTG TTG CTG CTG CTA ATA GC-3' and

DP5-R: 5'- CGC GGA TCC TGT ACA ACT AAG GGG AAT ACA AG-3'

DP5-R has an *Bam*HI site (underlined) for ligation to the
30 right flanking sequence and also introduces a unique *Bsr*GI site (bold face) at the 5'-end of the former Ad5 penton region.

The right flanking sequence was amplified using:

DP3-F: 5'-CGC GGA TCC CTT AAG GCA AGC ATG TCC ATC CTT-3' and

35 DP3-3R: 5'- AAA ACA CGT TTT ACG CGT CGA CCT TTC-3'

DP3-F has an BamHI site (underlined) for ligation to the left flanking sequence and also introduces a unique AflIII site (bold face) at the 3'-end of the former Ad5 penton region. The two resulting PCR fragments were digested with BamHI and ligated together. Then this ligation mixture was digested with AvrII and BglII. pBr/XN was also digested with AvrII and BglII and the vector fragment was ligated to the digested ligated PCR fragments. The resulting clone was named pBr/Ad.Δ penton. Penton coding sequences from serotypes other than Ad5 were PCR amplified such that the 5' and 3' ends contained the BsrGI and AflIII sites respectively. Introduction of these heterologous penton sequences in pBr/Ad.Δpenton generates constructs named pBr/Ad.pentonXX where XX represents the number of the serotype corresponding to the serotype used to amplify the inserted penton sequences. Subsequently the new penton sequences were introduced in the pWE/Ad.AflIII-rITR construct by exchanging the common FseI fragment. Importantly, in stead of pWE/Ad.AflIII-rITR it is also possible to insert the FseI fragment from pBr/Ad.pentonXX into a pWE/Ad.AflIII-rITR/HexXX or an pWE/Ad.AflIII-rITR/FibXX vector having a modified hexon and/or fiber sequence respectively. In this way the plasmid-based system to generate adenoviruses enables flexible design of any adenovirus with any desired characteristic concerning efficiency and specificity of infection of the target cell as well as immunogenicity.

Amplification of penton sequences from adenovirus serotypes

To enable amplification of the DNAs encoding penton protein derived from alternative serotypes oligonucleotides were synthesized. Of each adenovirus subgroup the penton sequence of only one member is known to date. Therefore, oligonucleotides were designed based on the known sequences. Thus, for amplification of penton sequences from subgroup C oligonucleotides P5-for (5'-

gctc gatgtacaatg cggcg cggcg gatgtat-3') and P5-rev (5'-
gctcgacttaagtcaaaaagtgcgggctcgatag-3') were used. For the
amplification of penton sequences from subgroup B
oligonucleotides P3-for (5'gctc gatgtacaatgaggagacgagccg
5 tgcta-3') and P3-rev (5'-gctcgacttaagttagaaagtgcgggcttgaaag-
3') were used. For the amplification of penton sequences from
subgroup D oligonucleotides P17-for (5'gctc gatgtacaatgaggcgt
gcggtggtgtcttc-3') and P17-rev (5'-gctcgacttaagttagaaggtgcg
actggaagc-3') were used. For the amplification of penton
10 sequences from subgroup F oligonucleotides PF-for (5'-
gctc gatgtacaatgagacgtgcgggtgggagtg-3') and PF-rev (5'-gctcga
cttaagttaaaacgtgcggctagacag-3') were used. All above
described forward oligonucleotides contain a BsrGI
restriction site at their 5'-end and all reverse
15 oligonucleotides contain an AflII restriction site at the 5'-
end.

The amplification reaction (50 µl) contained 2 mM dNTPs, 25
pmol of each oligonucleotide, standard 1x PCR buffer, 1,5 mM
MgCl₂, and 1 Unit Pwo heat stable polymerase (Boehringer) per
20 reaction. The cycler program contained 20 cycles, each
consisting of 30 sec. 94°C, 60 sec. 60-64°C, and 120 sec. At
72°C. One-tenth of the PCR product was run on an agarose gel
which demonstrated that a DNA fragment was amplified. Of each
different template, two independent PCR reactions were
25 performed after which the independent PCR fragments obtained
are sequenced to determine the nucleotide sequence. Of the 51
human serotypes 20 penton sequences have been amplified.

Generation of penton chimaeric adenoviral DNA constructs

30 All amplified penton DNAs as well as the vector (pBr/Ad.Δ
penton) were digested with BsrGI and AflII. The digested DNAs
was subsequently run on a agarose gel after which the
fragments were isolated from the gel and purified using the
GeneClean kit (Bio101 Inc). The PCR fragments were then
35 cloned into the BsrGI and AflII sites of pBr/Ad.Δpenton, thus
generating pBr/Ad.pentonXX (where XX stands for the serotype

number of which the penton DNA was isolated). So far the penton sequence of serotypes 2, 3, 5, 6, 7, 11, 21, 26, 35, 39, 40, 41, 42, 47, 48, 49 and 51 have been cloned into pBr/Ad.pentonXX . From pBr/Ad.pentonXX an 5.1 kb FseI
5 fragment encompassing the penton sequence was isolated via gelelectrophoresis and GeneClean. This FseI fragment was subsequently cloned in cosmid pWE/Ad.AflIII-rITR (see example 1) which was digested to completion with FseI and dephosphorylated as described previously. This cosmid cloning
10 resulted in the formation of construct pWE/Ad.AflIII-rITR/PentonXX (where XX stands for the serotype number of which the penton DNA was isolated).

15 Generation of recombinant adenovirus chimaeric for penton protein

To generate recombinant Ad 5 virus carrying the Penton of alternative serotypes two constructs, pCLIP.Luc and pWE/Ad.AflIII-rITR/PenXX were transfected into adenovirus producer cells.
20 For transfection, 4 µg of pCLIP.Luc and 4 µg of pWE/Ad.AflIII-rITR/PentonXX) were diluted in serum free DMEM to 100 µl total volume. To this DNA suspension 100 µl 1x diluted lipofectamine (Gibco) was added. After 30 minutes at room temperature the DNA-lipofectamine complex solution was added
25 to 2.5 ml of serum-free DMEM which was subsequently added to a T25 cm² tissue culture flask. This flask contained 2x10⁶ PER.C6 cells that were seeded 24-hours prior to transfection. Two hours later, the DNA-lipofectamine complex containing medium was diluted once by the addition of 2.5 ml DMEM
30 supplemented with 20% fetal calf serum. Again 24 hours later the medium was replaced by fresh DMEM supplemented with 10% fetal calf serum. Cells were cultured for 6-8 days, subsequently harvested, and freeze/thawed 3 times. Cellular debris was removed by centrifugation for 5 minutes at 3000
35 rpm room temperature. Of the supernatant (12.5 ml) 3-5 ml was

used to infect again infect PER.C6 cells (T80 cm² tissue culture flasks). This re-infection results in full cytopathogenic effect (CPE) after 5-6 days after which the adenovirus is harvested as described above.

5

The above described examples 1-9 encompasses the construction of recombinant adenoviral vectors, chimaeric for either fiber protein or hexon protein which results in an altered infection host range or altered immune response towards adenoviral vectors. These chimaeric adenoviral vectors are generated for the purpose of gene transfer and recombinant DNA vaccines. It must be stressed that in a manner analogous as described under example 1-9 chimaeric adenoviral vectors are constructed for penton and can be constructed for all other adenovirus proteins including but not limited to DNA encoding for small proteins required for adenovirus assembly and sequences required for adenovirus replication. Moreover, it must be emphasized that with this technology double, triple, quadruple, etc chimaeric adenoviral vectors can be constructed with the aim to combine parts of existing adenovirus serotypes to generate adenoviral vectors with preferred characteristics for any given target cell or target disease.

25

Legends to figures and tables

5 Table 1: Summary of the classification of known human adenovirus serotypes based upon the principle of hemagglutination.

Table 2: Association of human adenovirus serotypes with
10 human disease.

Table 3: Oligonucleotides and degenerate oligonucleotides used for the amplification of DNA encoding for fiber protein derived from alternative human adenovirus serotypes. Bold
15 letters in oligonucleotides A-E represent an NdeI restriction site. Bold letters in oligonucleotides 1-6 and 8 represent an NsiI restriction site. Bold letters in oligonucleotide 7 represent a PacI restriction site.

20 Table 4: Production results of fiber chimaeric adenoviruses. The number of virus particles per ml were determined using HPLC. The number of infectious units (IU) per milliliter were determined through titration on human 911 cells. For
infection experiments, the number of virus particles per
25 milliliter is taken from all chimaeric adenoviruses since IU/ml reflects a receptor mediated process.

Table 5: Transduction results of human cell lines and primary cells. A549: Human lung carcinoma cell line (ATCC,
30 CCL-1185). K562: Human erythroid leukemia (ATCC, CCL-243). SupT1: Human Lymphoblast hybrid B and T (ATCC, CRL-1991). GM09503: Human primary fibroblasts. HEPG2: Human liver carcinoma (ATCC, HB8065). CEM: human lymphoblast cells (ATCC, CRL-1992). HeLa: Human cervix carcinoma (ATCC, CCL-2).
35 Primary amniocytes and chorionvilli cells were obtained from department of antropogenetics, Leiden, The Netherlands.

Primary Smooth muscle cells and synoviocytes were obtained from TNO-PG, Leiden, The Netherlands. Shown are the luciferase activity (in relative light units (RLU) per μg protein) measurements of cells infected at MOI 5000 virusparticles per cell.

Table 6: Expression of integrins $\alpha_v\beta_3$ and $\alpha_v\beta_5$, the Coxsackie adenovirus receptor (CAR), and MHC class I on the membranes of target cells. In addition to the cells described in table 5: HUVEC: human umbilical vein endothelial cells were obtained from TNO-PG, Leiden, The Netherlands. Shown is the percentage of cells expressing either molecule on their membrane. The Ad5 based vector carrying a fiber of one representative of each subgroup and the efficiency of infection is shown on the right of the table. ND: not determined. 0% means undetectable expression of the molecule on the membrane of the cell using flow cytometry. 100% means high expression of the molecule on the cell membrane.

Figure 1: Schematic presentation of adapter plasmid pMLPI.TK.

Figure 2: Schematic presentation of adapter plasmid pAd/L420-HSA.

Figure 3: Schematic presentation of adapter plasmid pAd5/CLIP

Figure 4: Schematic presentation of a two plasmid system for the generation of recombinant adenoviruses.

Figure 5: Schematic presentation of a three plasmid system for the generation of recombinant adenoviruses.

Figure 6: Schematic presentation of generation of plasmid pBr/AdBamRDeltaFib in which part of the Adenovirus type 5 fiber DNA is replaced by a short DNA stretch containing a unique NsiI site.

Figure 7: Fiber protein sequences of adenovirus serotypes 8, 9, 13, 14, 20, 23, 24, 25, 27, 28, 29, 30, 32, 33, 34, 35, 36, 37, 38, 39, 42, 43, 44, 45, 46, 47, 48, 49, and 51. Bold letters represent part of the tail of adenovirus serotype 5. If bold letters not present it means that a PCR fragment was sequenced which did not contain the Ad5 tail. An X, present in the sequence means unidentified amino acid due to unidentified nucleotide. At the end of the sequence the stop codon of the fiber is presented by a dot.

Figure 8: Comparison of the *in vivo* biodistribution of I^{123} labeled adenovirus serotype 5 and an adenovirus chimaeric for fiber protein. Radiolabeled adenovirus (10^{10} virus particles, 0.1-2 MBq) was intravenously administered into the tail vein. As a control, a similar amount of free label was injected into the control animal. Rats were sacrificed after one hour and organs calibrated. Radioactivity of the in the figure indicated organs was measured with a scintillation counter and is expressed as counts per minute per gram tissue.

Figure 9: Schematic presentation of the generation of plasmid pBr/Ad.Eco-Pme Δ Hexon. Also shown is the sequence of the oligonucleotides delta hex 1-4 used to delete the DNA encoding for the hexon of adenovirus serotype 5 protein.

Figure 10: Hexon protein sequences of adenovirus serotypes 34, 35, 36, and 41. An X, present in the sequence means unidentified amino acid due to unidentified nucleotide. At the end of the sequence the stop codon of the hexon is presented by a dot.

References

- Arnberg N., Mei Y. and Wadell G., 1997. Fiber genes of adenoviruses with tropism for the eye and the genital tract. *Virology* 227: 239-244.
- Bout A., 1997. Gene therapy, p. 167-182. In: D.J.A. Crommelin and R.D. Sindelar (ed.), *Pharmaceutical biotechnology*, Harwood Academic Publishers.
- Bout, A. 1996. Prospects for human gene therapy. *Eur. J. drug Met. And Pharma.* 2, 175-179.
- Blaese et al., *Cancer Gene Ther.*, 2 (1995):291-297).
- Brody and Crystal, *Ann. N. Y. Acad. Sci.* 716(1994):90-101.
- Chroboczek J., Ruigrok R.W.H., and Cusack S., 1995. Adenovirus fiber, p. 163-200. In: W. Doerfler and P. Bohm (ed.), *The molecular repertoire of adenoviruses*, I. Springer-Verlag, Berlin.
- Defer C., Belin M., Caillet-Boudin M. and Boulanger P., 1990. Human adenovirus-host cell interactions; comparative study with members of subgroup B and C. *Journal of Virology* 64 (8): 3661-3673.
- De Jong, J.C., Wermenbol, A.G., Verweij-Uijterwaal, M.W., Slaterus, K.W., Wertheim-van Dillen, P., van Doornum, G.J.J., Khoo, S.H., and Hierholzer, J.C. (1998) Adenoviruses from HIV-infected patients, including two new candidate serotypes Ad50 and Ad51 of Subgenus D and B1 respectively. In preparation.
- Eisenlohr, L.C., Gerard, W., and Hackett, C.J. (1987). Role of receptor-binding activity of the viral hemagglutinin

molecule in the presentation of influenza virus antigens to helper T-cells. *J. Virol* 61, 1375-1383

Eiz B and Pring-^okerblom P., 1997. Molecular characterization of the type-specific g-determinant located on the adenovirus fiber. *Journal of Virology* 71: 6576-6581.

Francki, R.I.B., Fauquet, C.M., Knudson, D.L. and Brown, F. (1991) Classification and nomenclature of viruses. Fifth report of the international Committee on taxonomy of viruses. *Arch. Virol. Suppl.* 2, 140-144

GahÈry-SÈgard H., Farace F., Godfrin D., Gaston J., Lengagne R., Tursz T., Boulanger P. and Guillet J., 1998. Immune response to recombinant capsid proteins of adenovirus in humans: antifiber and anti-penton base antibodies have a synergistic effect on neutralizing activity. *Journal of Virology* 72: 2388-2397.

Gall J., Kass-Eisler A., Leinwand L. and Falck-Pedersen E., 1996. Adenovirus type 5 and 7 capsid chimera: fiber replacement alters receptor tropism without affecting primary immune neutralization epitopes. *Journal of Virology* 70 (4): 2116-2123.

Greber, U.F., Willets, M., Webster, P., and Helenius, A. (1993). Stepwise dismantling of adenovirus 2 during entry into cells. *Cell* 75, 477-486.

Hynes, R.O. (1992) Integrins: versatility, modulation and signalling in cell adhesion. *Cell* 69, 11-25

Herz and Gerard, *Proc. Natl. Acad. Sci. U.S.A.*, 96 (1993):2812-2816

Hierholzer, J.C. (1992) Adenovirus in the immunocompromised host. Clin. Microbiol Rev. 5, 262-274.

Hierholzer, J.C., Wigand, R., Anderson, L.J., Adrian, T., and Gold, J.W.M. (1988) Adenoviruses from patients with AIDS: a plethora of serotypes and a description of five new serotypes of subgenus D (types 43-47). J. Infect. Dis. 158, 804-813.

Ishibashi, M. and Yasue (1983) in Adenoviruses of Animals, Chapter 12, p497-561

Kay, R., Takei, F., and Humphries, R.K. (1990). Expression cloning of a cDNA encoding M1/69-J11d heat-stable antigens. J. Immunol. 145 (6), 1952-1959

Khoo, S.H., Bailey, A.S., De Jong, J.C., and Mandal, B.K. (1995). Adenovirus infections in human immunodeficiency virus-positive patients: Clinical features and molecular epidemiology. J. Infect. Dis 172, 629-637

Kidd, A.H., Chrboczek, J., Cusack, S., and Ruigrok, R.W. | H. (1993) Adenovirus type 40 virions contain two distinct fibers. Virology 192, 73-84.

Krasnykh V.N., Mikheeva G.V., Douglas J.T. and Curiel D.T., 1996. Generation of recombinant adenovirus vectors with modified fibers for altering viral tropism. Journal of Virology 70(10): 6839-6846.

Krasnykh V., Dmitriev I., Mikheeva G., Miller C.R., Belousova N. and Curiel D.T., 1998.

Characterization of an adenovirus vector containing a heterologous peptide epitope in the HI loop of the fiber knob. Journal of Virology 72(3): 1844-1852.

Leopold, P.L., Ferris, B., Grinberg, I., Worgall, S., Hackett, N.R., and Crystal, R.G. (1998). Fluorescent virions: Dynamic tracking of the pathway of adenoviral vectors in living cells. *Hum. Gene Ther.* 9, 367-378.

Levrero, M., Barban, V., Manteca, S., Ballay, A., Balsamo, C., Avantaggiata, M.L., Natoli, G., Skellekens, H., Tiollais, P., and Perricaudet, M. (1991). Defective and non-defective adenovirus vectors for expression foreign genes in vitro and in vivo. *Gene* 101, 195-202.

Matlin, K.S., Reggio, H., Helenius, A., and Simons, K. (1981). Infectious entry pathway of influenza virus in a canine kidney cell line. *J. Cell Biol.* 91, 601-613

Morgan, C., Rozenkrantz, H.S., and Mednis, B. (1969). Structure and development of viruses as observed in the electron microscope. X. Entry and uncoating of adenovirus. *J. Virol* 4, 777-796.

Roest, P.A.M., Bout, M., van der Tuijn, A.C., Ginjaar, I.B., Bakker, E., Hogervorst, F.B.L., van Ommen, G-J. B., den Dunnen, J.T. (1996). *J. Med. Genet.* 33, 935-939.

Roest P.A.M., van der Tuijn, A.C., Ginjaar, I.B., Hoeben, R.C., Hogervorst, F.B.L., Bakker, E, den Dunnen, J.T. van Ommen, G-J. B. (1996). *Neuromusc. Disord.* 6 (no. 3), 195-202.

Roest P.A.M., van der Tuijn, A.C., Ginjaar, I.B., Hoeben, R.C., Hogervorst, F.B.L., Bakker, E, den Dunnen, J.T. van Ommen, G-J. B. (1999). *Lancet* 353, 727-728.

Richman, D.D., Hostetler, K.Y., Yazaki, P.J., and Clark, S. (1986). Fate of influenza A virion proteins after entry into subcellular fractions of LLC cells and the effect of amantadine. *Virology* 151, 200-210

Stevenson S.C., Rollence M., White B., Weaver L. and McClelland A., 1995.

Human adenovirus serotypes 3 and 5 bind to two different cellular receptors via the fiber head domain. *Journal of Virology* 69(5): 2850-2857.

Stevenson S.C., Rollence M., Marshall-Neff J. and McClelland A., 1997. Selective targeting of human cells by a chimaeric adenovirus vector containing a modified fiber protein. *Journal of Virology* 71(6): 4782-4790.

Signas, G., Akusjarvi, G., and Petterson, U. (1985). Adenovirus 3 fiberpolypeptide gene: Complications for the structure of the fiber protein. *J. Virol.* 53, 672-678.

Stouten, P.W.F., Sander, C., Ruigrok, R.W.H., and Cusack, S. (1992) New triple helical model for the shaft of the adenovirus fiber. *J. Mol. Biol.* 226, 1073-1084.

Schulick, A.H., Vassalli, G., Dunn, P.F., Dong, G., Rade, J.J., Zamarron, C. and Dichek, D.A. (1997). Established immunity precludes adenovirus-mediated gene transfer in rat carotid arteries.

Schnurr, D and Dondero, M.E. (1993) Two new candidate adenovirus serotypes *Intervirology*. 36, 79-83

Svensson, V. and Persson, R. (1984). Entry of adenovirus 2 into Hela cells. *J. Virol.* 51, 687-694.

Varga, M.J., Weibull, C., and Everitt, E. (1991). Infectious entry pathway of adenovirus type 2. *J. Virol* 65, 6061-6070.

Wickham T.J., Carrion M.E. and Kovesdi I., 1995. Targeting of adenovirus penton base to new receptors through replacement

of its RGD motif with other receptor-specific peptide motifs.
Gene Therapy 2: 750-756.

Wickham T.J., Segal, D.M., Roelvink, P.W., Carrion M.E., Lizonova, A., Lee, G-M., and Kovesdi, I. (1996). Targeted adenovirus gene transfer to endothelial and smooth muscle cells by using bispecific antibodies. J. Virol. 70 (10), 6831-6838

Wickham, T.J., Mathias, P., Cherish, D.A., and Nemerow, G.R. (1993) Integrins avb3 and avb5 promote adenovirus internalisation but not virus attachment. Cell 73, 309-319

Table 1

Subgroup	serotypes	hemagglutination rhesus	hemagglutination rat
A	12, 18, 31	-	+/-
B	3, 7, 11, 14, 16, 21, 34, 35, 51	+	-
C	1, 2, 5, 6	-	+/-
D	8-10, 13, 15, 17, 19, 20, 22-30 ,32, 33, 36-39, 42-47, 49, 50	+/-	+
E	4	-	+/-
F	40, 41	-	+/-

Table 2

Syndrom	Subgenus	Serotype
Respiratory illness	A	31
	B	3, 7, 11, 14, 21, 34, 35, 51
	C	1, 2, 5, 6
	D	39, 42-48
	E	4
Keratoconjunctivitis (eye)	B	11
	D	8, 19, 37, 50
Hemorrhagic cystitis (Kidney)	B	7, 11, 14, 16, 21, 34, 35
And urogenital tract infections	C	5
	D	39, 42-48
Sexual transmission	C	2
	D	19, 37
Gastroenteritis	A	31
	B	3
	C	1, 2, 5
	D	28
	F	40, 41
CNS disease	A	12, 31
	B	3, 7
	C	2, 5, 6
	D	32, 49
Hepatitis	A	31
	C	1, 2, 5
Disseminated	A	31
	B	3, 7, 11, 21
	D	30, 43-47
None (???)	A	18
	D	9, 10, 13, 15 17, 20, 22-29, 33, 36, 38

Table 3

<u>Serotype</u>	<u>Tail oligonucleotide</u>	<u>Knob oligonucleotide</u>
4	A	1
8	B	2
9	B	2
12	E	3
16	C	4
19p	B	2
28	B	2
32	B	2
36	B	2
37	B	2
40-1	D	5
40-2	D	6
41-s	D	5
41-1	D	7
49	B	2
50	B	2
51	C	8

A: 5'- CCC GTG TAT CCA **TAT GAT** GCA GAC AAC GAC CGA CC- 3'

B: 5'- CCC GTC TAC CCA **TAT GGC** TAC GCG CGG- 3'

C: 5'- CCK GTS TAC CCA **TAT GAA** GAT GAA AGC- 3'

D: 5'- CCC GTC TAC CCA **TAT GAC** ACC TYC TCA ACT C- 3'

E: 5'- CCC GTT TAC CCA **TAT GAC** CCA TTT GAC ACA TCA GAC- 3'

1: 5'- CCG **ATG CAT** TTA TTG TTG GGC TAT ATA GGA - 3'

2: 5'- CCG **ATG CAT** TYA TTC TTG GGC RAT ATA GGA - 3'

3: 5'- CCG **ATG CAT** TTA TTC TTG GGR AAT GTA WGA AAA GGA - 3'

4: 5'- CCG **ATG CAT** TCA GTC ATC TTC TCT GAT ATA - 3'

5: 5'- CCG **ATG CAT** TTA TTG TTC AGT TAT GTA GCA - 3'

6: 5'- GCC **ATG CAT** TTA TTG TTC TGT TAC ATA AGA - 3'

7: 5' - CCG **TTA ATT** AAG CCC TTA TTG TTC TGT TAC ATA AGA A - 3'

8: 5'- CCG **ATG CAT** TCA GTC ATC YTC TWT AAT ATA - 3'

Table 4

Adenovirus	Virus particles/ ml	Infectious units/ ml
Ad5Fib5	2.2×10^{12}	6.8×10^{11}
Ad5Fib12	4.4×10^{12}	1.9×10^{12}
Ad5Fib16	1.4×10^{12}	3.0×10^{10}
Ad5Fib17	9.3×10^{11}	9.5×10^9
Ad5Fib28	5.4×10^{10}	2.8×10^8
Ad5Fib32	2.0×10^{12}	1.1×10^{12}
Ad5Fib40-S	3.2×10^{10}	1.0×10^{10}
Ad5Fib40-L	2.0×10^{12}	6.4×10^{11}
Ad5Fib49	1.2×10^{12}	4.3×10^{11}
Ad5Fib51	5.1×10^{12}	1.0×10^{12}

Table 5

Cellline	Ad5Fiber5	Ad5Fiber12	Ad5Fiber1	Ad5Fiber28	Ad5Fiber32	Ad5Fiber40-S	Ad5Fiber40-L	Ad5Fiber49	Ad5Fiber51
A549	54186	2	283339	3556	46635	84562	407130	2	18337
K562	1	5	109688	7915	30958	1086	1907	1524	172569
SupT1	3926082	606032	14553005	855043	80834	ND	686546	77	1266653
GM09503	506	4	117094	1858	39652	52759	609	4	106309
1° chorionvilli	75	147	1026757	203114	9756	ND	1688026	49	1512035
1° Amnionvilli	8420131	4975463	6991792	37512	3313879	ND	5250524	4081	5785404
HEPG2	10861240	11428921	19315715	962463	3844661	ND	90713451	23894	8003123
HeLa	6838148	510784	776984	13571	15600	1551397	1694919	103	163415
CEM	93	6	1600	0	69	9	18	6.5	53
Synoviocytes	103	ND	9936417	ND	ND	ND	ND	ND	ND
Smooth muscle cells	19019	664	816381	621	ND	ND	38632	ND	ND

Table 6

Cellline	a,b3	a,b5	CAR	MHC class I	subgroup A	Subgroup B	Subgroup C	Subgroup D	Subgroup F
A549	17%	98%	100%	ND	Ad5Fiber12 Low	Ad5Fiber16 High	Ad5Fiber5 High	Ad5Fiber 32 High	Ad5Fiber40-L High
K562	12%	55%	0%	15%	Low	High	Low	High	High
GM09503	20%	50%	0%	100%	Low	High	Low	High	Low
CEM	0%	0%	3%	100%	Low	High	Low	Low	Low
SupT1	5%	1%	70%	100%	High	High	High	High	High
Smooth muscle cells	100%	70%	0%	15%	Low	High	Low	ND	Low
HUVEC	100%	15%	10%	90%	ND	High	Low	ND	ND
Synoviocytes	30%	40%	0%	100%	ND	High	Low	ND	ND
1 ^o chorionvilli	100%	0%	12%	100%	Low	High	Low	Low	High
HepG2	0%	10%	100%	80%	High	High	High	High	High

CLAIMS

1. A chimaeric adenovirus comprising at least a part of a fiber protein of an adenovirus serotype providing the chimaeric virus with a desired host range and at least a part of a penton or hexon protein from another less antigenic adenovirus serotype resulting in a less antigenic chimaeric adenovirus.
5
2. A recombinant vector derived from an adenovirus comprising at least one ITR and a packaging signal having an insertion site for a nucleic acid sequence of interest, and further having an insertion site for functionally inserting a gene encoding a penton and/or a hexon protein of a first serotype of adenovirus and having an insertion site for a gene encoding a fiber protein of a second adenovirus of a different serotype.
10
3. A recombinant vector according to claim 2 which is a plasmid.
15
4. A packaging cell for producing a chimaeric adenovirus according to claim 1, comprising in trans all elements necessary for adenovirus production not present on the adenoviral vector according to claim 2.
20
5. A kit of parts comprising a packaging cell according to claim 4 and a recombinant vector according to claim 2 or 3, whereby there is essentially no overlap leading to recombination resulting in the production of replication competent adenovirus between said cell and said vector.
25
6. A vector according to claim 2 or 3 where the insertion sites are different and preferably unique restriction sites.
7. A method for producing a chimaeric adenovirus having a desired host range and diminished antigenicity, comprising providing a vector according to claim 2, inserting into said vector at least a functional part of a penton or hexon protein derived from an adenovirus serotype having relatively low antigenicity, inserting at least a functional part of a
30

fiber protein derived from an adenovirus serotype having the desired host range and transfecting said vector in a packaging cell according to claim 4 and allowing for production of chimaeric viral particles.

- 5 8. A method according to claim 7, wherein said reduced antigenicity is a diminished capability to raise neutralizing antibodies.
9. A chimaeric adenovirus according to claim 1, wherein the hexon, penton and/or fiber proteins are chimaeric proteins
10 originating from different adenovirus serotypes.
10. A nucleic acid library comprising nucleic acid derived from different adenovirus serotypes.

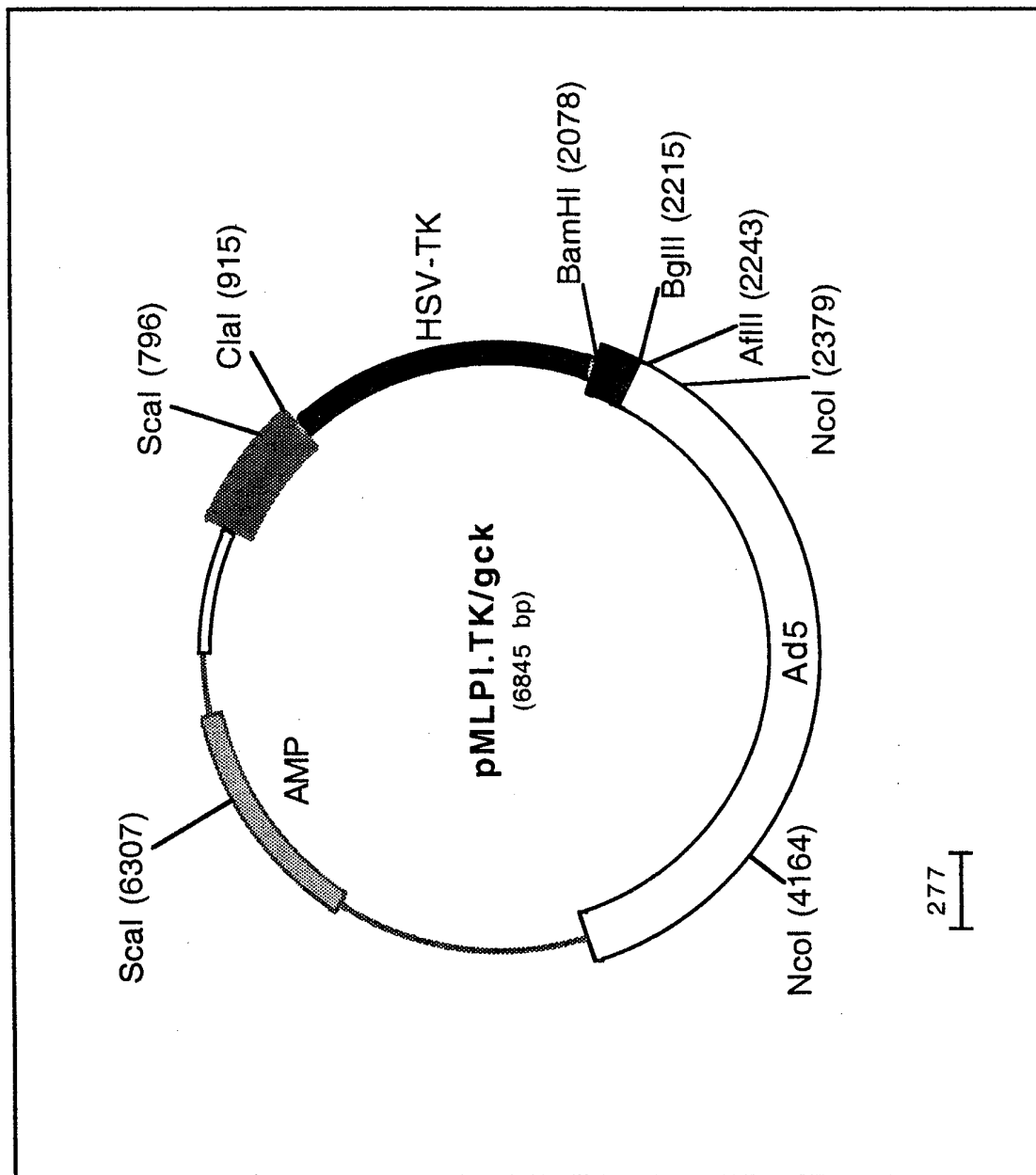
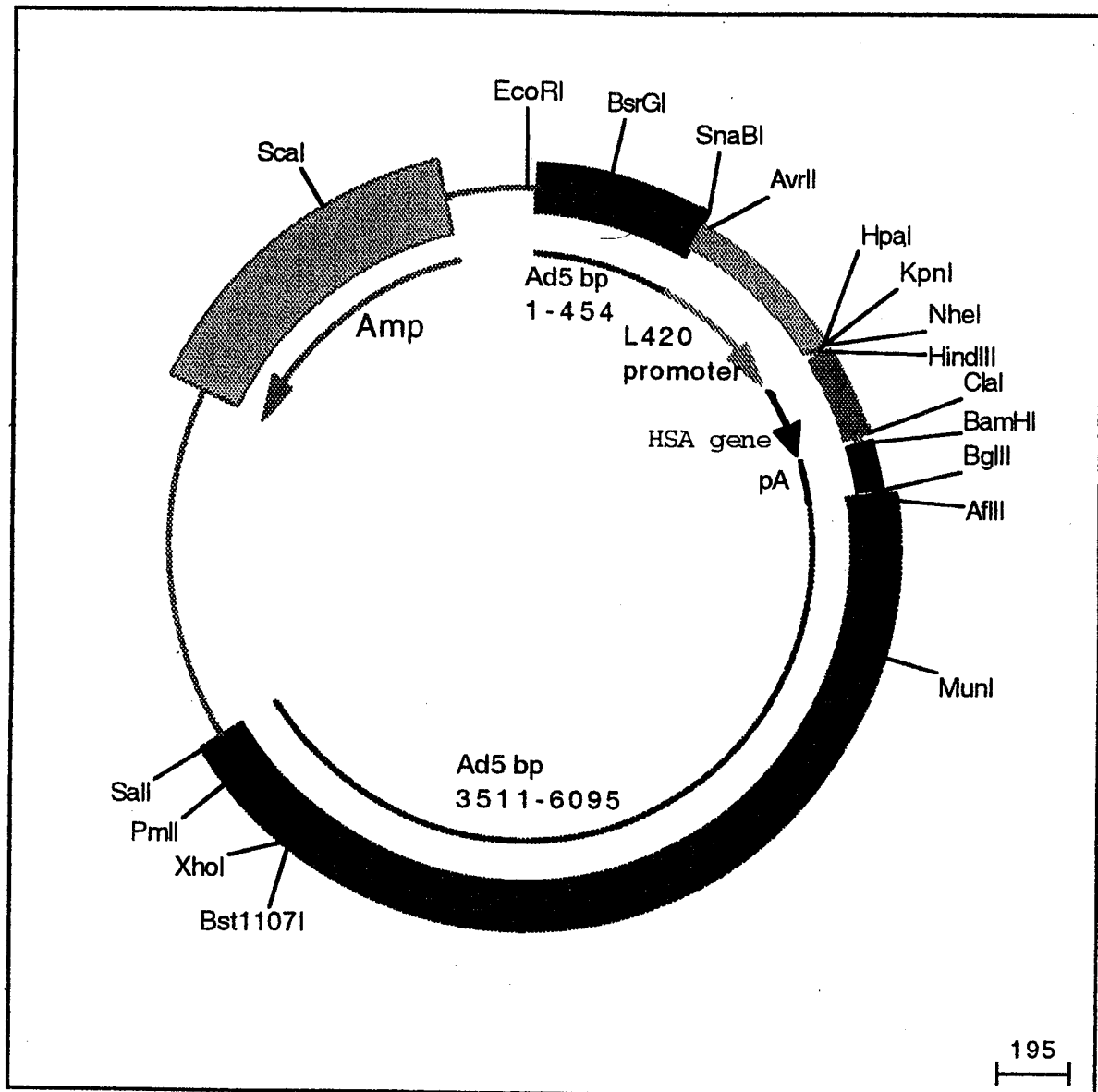

Figure 1

Figure 2



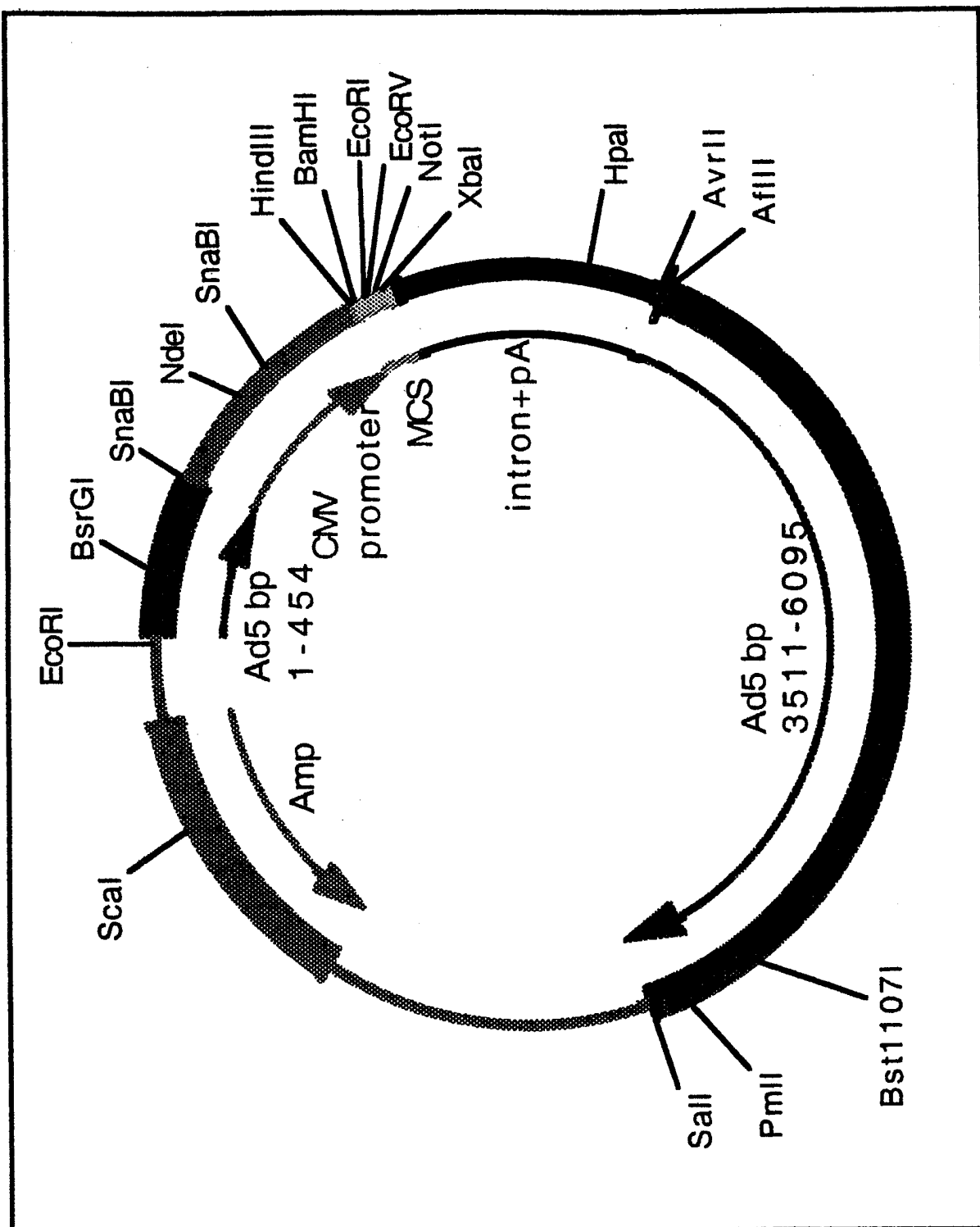

Figure 4

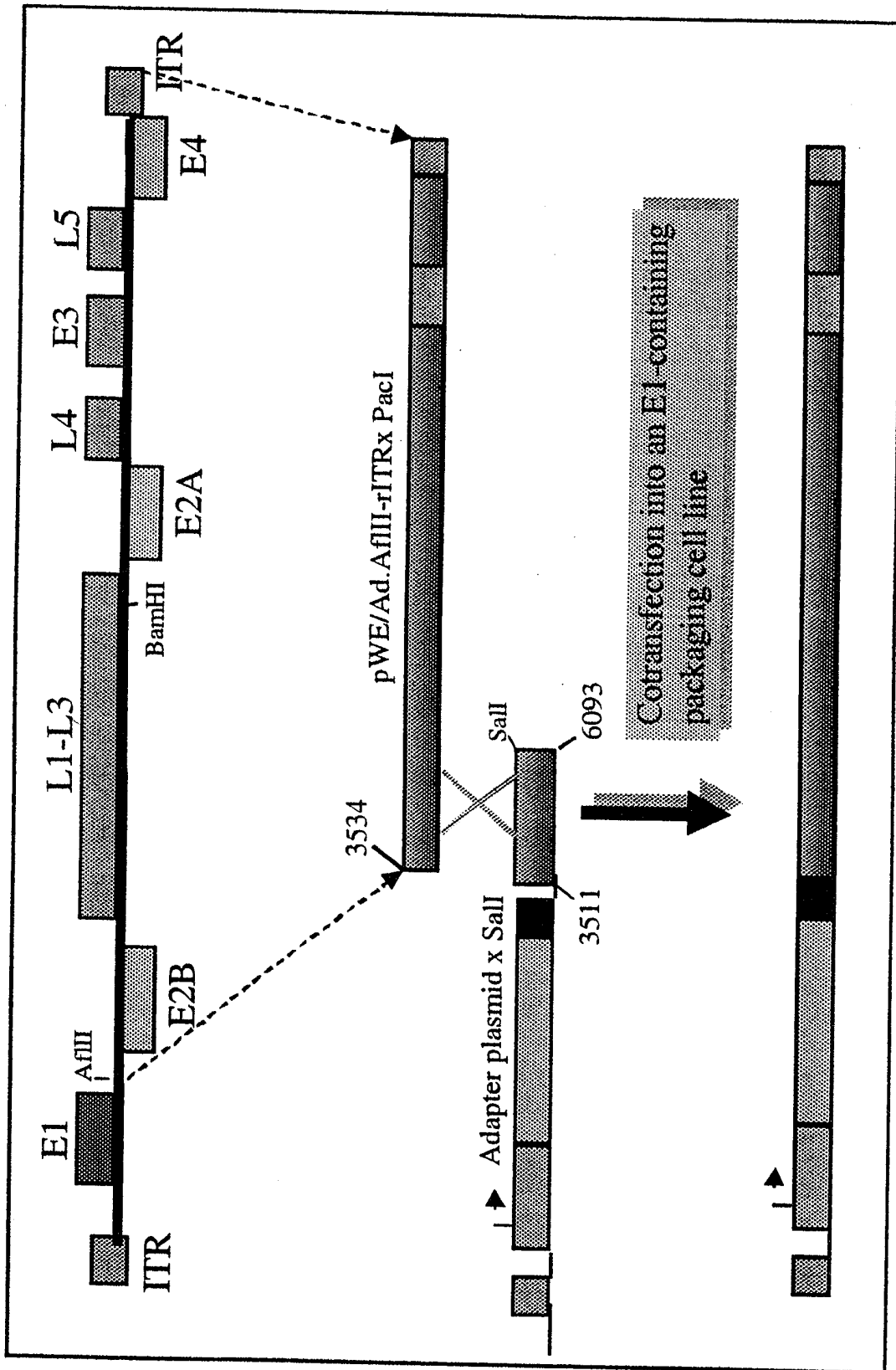

Figure 5

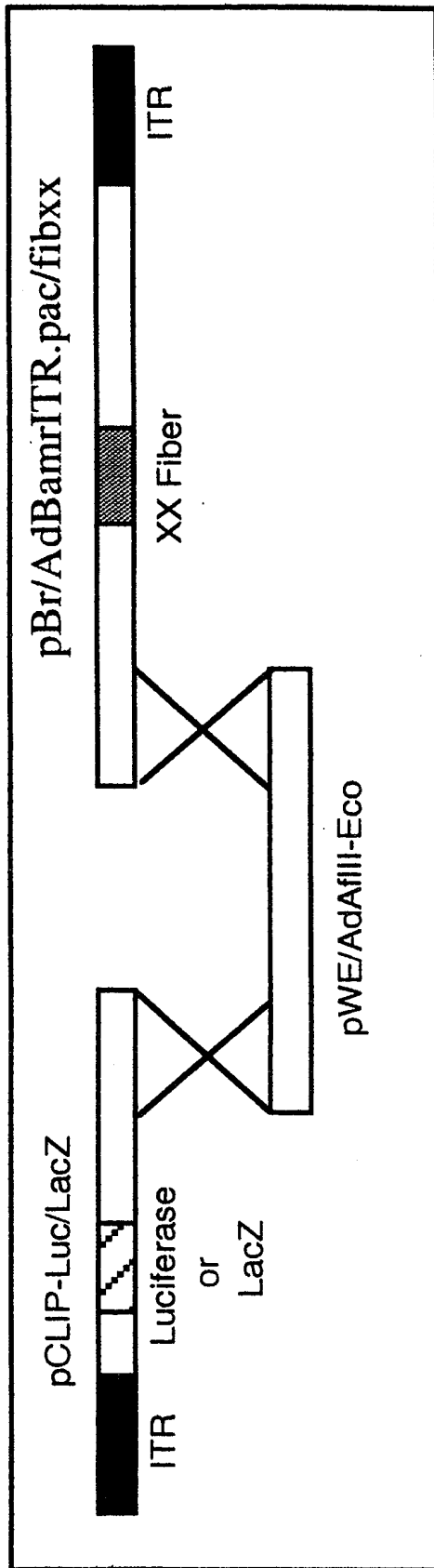

Figure 6

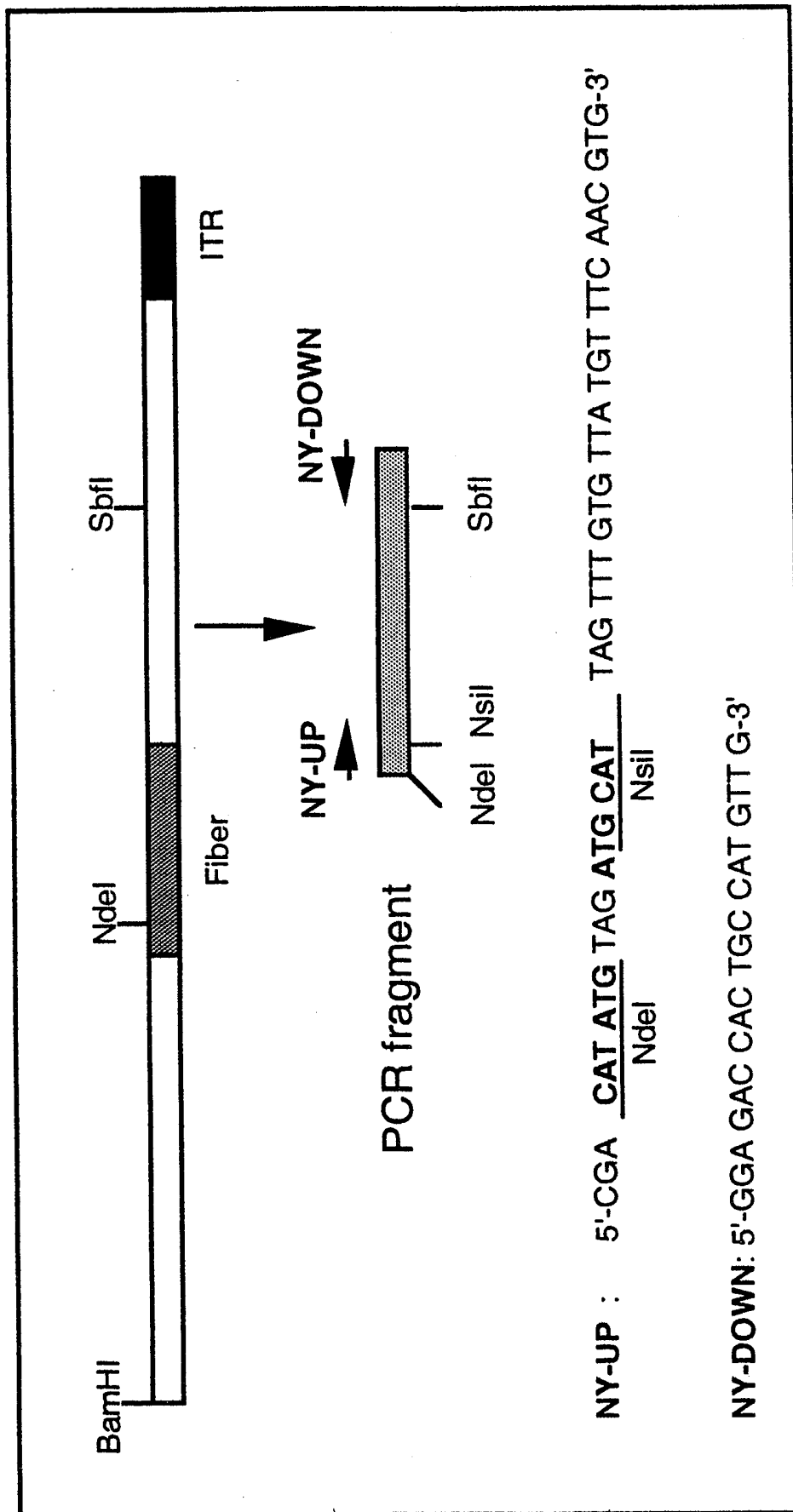

Figure 7:

1.1: Serotype 8 fiber protein

SCSCPSAPTIFMLLQMKRARPS EDTFNPVYPYGYARNQNIPFLTPPFVSSNGFQ
NFPPGVLSLKLADPITINNQNVSLKVG GGLTLQEETGKLTVNTEPPLHLTNNKLG I
ALDAPFDVIDNKL TLLAGHGLSIITKETSTLPGLVNTLVVLTGKGIGTDLSNNGGN
ICVRVGE GGLSFNDNGDLVAFNKKEDKRTLWTPDTSPNCRIDQDKDSLTLV
LTKCGSQILANVSLIVVAGRYKIINNNTNPALKGFTIKLLFDKNGVLMESSNLGKS
YWNFRNQNSIMSTAYEKAIGFMPNLVA YPKPTTGSKKYARDIVYGNIYLG GKP
QPVTIKTTFNQETGCEYSITFDFSWAKTYVNVEFETTSFTFSYIAQE.

1.2: Serotype 9 fiber protein

SCSCPSAPTIFMLLQMKRARPS EDTFNPVYPYGYARNQNIPFLTPPFVSSDGFQ
NFPPGVLSLKLADPIAVNGNVSLKVG GGLTLQDGTGKLTVNADPPLQLTNNK L
GIALDAPFDVIDNKL TLLAGHGLSIITKETSTLPGLINTLVVLTGKGIGTESTDNGG
SVCVRVGE GGLSFNNDGDLVAFNKKEDKRTLWTPDTSPNCKIDQDKDSLTL
VLTKCGSQILANVSLIVVAGKYKIINNNTQPALKGFTIKLLFDENGVLMESSNLGK
SYWNFRNENSIMSTAYEKAIGFMPNLVA YPKPTAGSKKYARDIVYGNIYLG GKP
DQPVTIKTTFNQETGCEYSITFDFSWAKTYVNVEFETTSFTFSYIAQE.

1.3: Serotype 13 fiber protein

XXXXXSAPTIFMLLQMKRARSSXDTFNPVYPYGYARNQNIXFXTPPFVXSDGF
KNFPPGVLSLKLADPITIANGDVSLKVG GGLTLQEGSLTVDPKAPLQLANDKKLE
LVYDDPFEVSTNKL SLKVGHGLKVLDDKSAGGLKDLIGKLVVLTGKGIGIENLQ
NDDGSSRGVGINVRLGTDGGLSFDRKGELVA WNRKDDRRTLWTPDPSPNCKA
ETEKDSLTLVLTKCGSQILATVSHVLK GK YEFVKKETEPKSFV KLLFDSKGV L
LPTS NLSKEYWNYRSYDNNIGTPYENA VPFMPNLKAYPKPTKTASDKAENKISS
AKNKIVSNFYFGGQAYQPGTHIKFNEEIDETCAYSITFNFGWGKVYDNPFPDTS
FTXS YIAQE.

1.4: Serotype 14 fiber protein

HPFINPGFISPNGFTQSPDGVLT LKCLTPLTTTGGSLQLKVG GGLTVDDTDGTLQE
NIGATTPLVKTGH SIGLSLGAGLGTDENKLCTKLGEGLTFNSNNICIDDNINTLWT
GVNPT EANCQMMDSSESNDCKLILTLVKTGALVTA FVYVIGVSNNFNMLT TYRN
INFTAELFFDSAGNLLTSLSSLKTPLNHKSGQTWLLVPLLMLKVSCPAQLLILSIIL
EKNKTTFT ELVTTQLVITLLFPLTISVMLNQRAIRADTSY CIRITWSWNTGDAPEG
QTSATTLVTS

1.5: Serotype 20 fiber protein

IQNIPFLTPPFVSSDGLQNFP PGVLSLKLADPIAVNGNVSLKVG GGITVEQDSGQL
IANPKAPLQVANDKLELSYAYPFETSANKLSLKV GQGLKVLDEKDSGGLQNL LG
KLVVLTGKGIGVEELKNPDNTNRGVGINVRLGKDGGLSFNKN GELVAWNKHND

Figure 7 cont.

TGTLWTTDPSPNCKIEEVKDSKLTLLVLTCKGSQILATMAFQVVKGTyenISKNT
AKNSFSIKLLFDDNGKLEGGSSLDKDYWNFRSDDSIIPNQYDNAVPFMPNLKAYP
KPSTVLPSTDKNSNGKNTIVSNLYLEGKAYQPVAVTITFNKEIGCTYSITFDGWA
KTYDVIPIFDSSSFT

1.6: Serotype 23 fiber protein

QNIPFLTTPPFVSSDGFQNFPPGVLSLKLADPIAITNGDVSLKVGGGGLTVEQDSGNL
KVNTKAPLQVAADKQLEIALADPFEVSKGRGKAGHGLKVIDNSISGLEGLVGT
LVVLTGHGIGTENLLNNDGSSRGVGINVRLGKDGGLSFDKKGDLVAWNKKYDT
RTLWTTDPSPNCKVIEAKDSKLTLLVLTCKGSQILANMSLLILKGTYEYISNAIAN
KSFTIKLLFNDKGVLMGSSLDKDYWNYKSDDSVMSKAYENA VPFMPNLKAYP
NPTTSTNPSTDKKSNKNAIVSNVYLEGRA YQPVAITITFNKETGCTYSMTDFD
GWSKVYNDPIPFDTSSLT

1.7: Serotype 24 fiber protein

SCSCPSAPTIFMLLQMKRARPSSEDTFNPVYPYGYARNQNIPFLTTPPFVSSDGFQ
NFPPGVLSLKLADPIAITNGDVSLKVGGGGLTVEKDSGNLKVNPAPLQVTTDKQL
EIALAYPFEVSNGLGKAGHGLKVIDKIAGLEGLAGTLVVLTKGKIGTENLENS
DGSSRGVGINVRLAKDGGLSFDKKGDLVAWNKHDDRRRTLWTTDPSPNCTIDQ
ERDSKLTLLVLTCKGSQILANVSLLVVKGKFSNINNNTNPTDKKITVKLLFNEKGV
LMDSSTLKKEYWNYRNDNSTVSAQYDNAVPFMPNKA YPKPTTDTSAKPEDKK
SAAKRYIVSNVYIGGLPKTVVITIKFNAETECAY SITFEFTWAKTFEDVQFDSSSF
TFSYIAQE.

1.8: Serotype 25 fiber protein

SCSCPSAPTIFMLLQMKRARPSSEDTFNPVYPYGYARNQNIPFLTTPPFVSSDGFQ
NFPPGVLSLKLADPITISNGDVSLKVGGGGLTVEQDSGNLSVNPAPLQVGTDKKL
ELALAPPFNVKDNKLDLLVGDGLKVIDKSISXLPGLLNLYLVVLTKGKIGNEELKN
DDGSNKGVLGCVRIGEGGGLTFDDKGYLVAWNKKHDIRTLWTTLDPSPNCRID
VDKDSKLTLLVLTCKGSQILANVSLLVVKGRFQNLNYKTNPPLPKTFTIKLLFDEN
GILKSSNLDKNYWNYRNGNSILAEQYKNAVGFMPNLAA YPKSTTTQSKLYAR
NTIFGNIYLDQA YNPVVIKITFNQEADSA YSITLNYSWGKDYENIPFDS

1.9: Serotype 27 fiber protein

IPFLTTPPFVSSDGFKNFPPGVLSLKLADPITITNGDVSLKVGGGGLVVEKESGKLSV
DPKTPLQVADNKLELSYNAPFKVENDKLSLDVGHGLK VIGNEVSSLPLINKLV
VLTGKIGTEELKEQNSDKIIGVGINVRARGGLSFDNDGYLVAWNPKYDTRTLW
TTPDTSPNCKMLTKKDSKLTLLVLTCKGSQILGNVSLLA VSGKYLNMTKDETGVKI
ILLFDRNGVLMQESSLDKEYWNYRNDNNVIGTPYENAVGFMPNLVA YPKPTSA
DAKNYSRSKIISNVYLKGLIYQPVIIASFNQETTNGCVYSISFDFTCSKDYTGQQF
DVTSF

1.10: Serotype 28 fiber protein

SCSCPSAPTIFMLLQMKRARPSSEDTFNPVYPYGYARNQNIPFLTTPPFVSSDGFQ
NFPPGVLSLKLADPITIANGDVSLKLGGGGLTVEKESGNLTVNPAPLQVASGQLE
LAYYSFPDVKNMMLTKAGHGLAVVTKDNTDLQPLMGTLVVLTKGKIGTGTS

Figure 7 cont.

HGGTIDVRIGKNGSLAFDKNGDLVAWDKENDRRTLWTTTPDTPSPNCKMSEVKDS
 KLTLILTKCGSQILGSVSLLA VKGEYQNM TASTNKNVKITLLFDANGVLLGSSL
 DKEYWNFRNNDSTVSGKYENAVPFMPNITAYKPVNSKSYARSHIFGNVYIDAKP
 YNPVVIKISFNQETQNNCVYSISFDYTC SKEYTGMQFDVTSFTFSYIAQE.

1.11: Serotype 29 fiber protein

QNIPFLTPPFVSSDGFKNFPPGVLSLKLADPIAITNGDVSLKVG GGLTVEQDSGNL
 SVNPKAPLQVGTDKKLELALAPPFDVRDNKLAILVGDGLKVIDRSISDLPGLLNY
 LVVLTGKGIGNEELKNDDGSNKGVGLCVRIGEGGGLTFDDKGYLVAWNNKHDI
 RTLWTTLDPSPNCKIDIEKDSKLTLLVLTCKCGSQILANVSLIIVNGKFKILNNKTDPS
 LPKSFNIKLLFDQNGVLLENSNIKQYLNFRSGDSILPEPYKNAIGFMPNLLAYAK
 ATTDQSKIYARNTIYGNIYLDNQPYNPVVIKIFNNEADSAYSITFNYSWTKDYD
 NIPFDSTSFTS

1.12: Serotype 30 fiber protein

SCSCPSAPTIFMLLQMKRARPSXDTFNPVYPYGYARNQNIPFXTPPFVXSDGFK
 NFPPGVLSLKLADPIAITNGDVSLKVG GGLTVEQDSGNLSVNXXAPLQVGTDKK
 LELALAPPFDVRDNKLAILVGDGLKVIDRSISDLPGLLNYLVVXTGKGIGNEELK
 NDDGSNKGVGLCVRIGEGGGLTXDDKGYLVAWNNKHDIRTLWTTLDPSPNCKI
 DIEKDSKLTLLVLTCKCGSQILANVSLIIVNGKFKILNNKTDPSLPKSFNIKLLFDQNG
 VLLENSNIKQYLNFRSGDSILPEPYKNAIGFMPNLLAYAKATTDQSKIYARNTIY
 GNIYLDNQPYNPVVIKIFNNEADSAYSITFNYSWTKDYDNIPFDSTSFTFSYIAQE

1.13: Serotype 32 fiber protein

SCSCPSAPTIFMLLQMKRARPSEDTFNPVYPYGYARNQNIPFLTPPFVSSDGFQ
 NFPPGVLSLKLADPITIANGNVSLKVG GGLTLEQDSGKLIVNPKAPLQVANDKLE
 LSYADPFETSANKLSLKVGHGLKVLDEKNAGGLKDLIGTLVVLTGKGIGVEELK
 NADNTNRGVGINVRLGKDGGLSFDKKGDLVAWNNKHDDRRTLWTTDPDPSNCTI
 DEERDSKLTLLVLTCKCGSQILANVSLLVVKGKFSNINNTNPTDKKITVKLLFNEK
 GVLMDSSSLKKEYWNYRNDNSTVSQAYDNAVPFMPNIKAYPKPTDTSKPED
 KKSAAKRYIVSNVYIGGLPDKTVVITIKLNAETESAYSMTFEFTWAKTFENLQFD
 SSSFTFSYIAQE.

1.14: Serotype 33 fiber protein

SCSCPSAPTIFMLLQMKRARPSEDTFNPVYPYGYARNQNIPFLTPPFVSSDGFK
 NFPPGVLSLKLADPITITNGDVSLKVG GGLTLQEGSLTVNPKAPLQLANDKKLEL
 VYDDPFVSTNKLKSLKVGHGLKVLDDKSAGGLQDLIGKLVVLTGKGIGIENLQN
 DDGSSRGVGINVRLGTDGGLSFDKRGELVAWNRKDDRRTLWTTDPDPSNCKAE
 TEKDSKLTLLVLTCKCGSQILATVSIIVLKGKYEYVKKETEPKSFVLLFDSKGVLL
 PTSNLSKEYWNYRSYDNNIGTPYENAVPFMPNLKAYPKPTKTASDKAENKISSA
 KNKIVSNFYFGGQAYQPGTIIKFNEEIDETCAYSITFNFGWGK VYDNPFPFDTTSF
 TFSYIAQE.

1.15: Serotype 34 fiber protein

10/16

Figure 7 cont.

**SCSCPSAPTIFMLLQMKRARPSEDTFNPVYPYEDESTSQHPFINPGFISPNGFTQ
SPDGVLTCLKCLPLTTTGGSLQLKVGGLTVDDTDGTLQKNIRATTPITKNNHSV
ELTIGNLETQHNLKCAKLGNGLKFNNGDICIKDSINTLWTGINPPPNCQIVENTN
TNDGKLTLLVVKNGGLVNGYVSLVGVSDTVNQMFQKTANIQLRLYFDSSGNL
LTDESDLKIPLKNKSSSTATSETVASSKAFMPSTTAYPFNTTTRDSENYIHGICYM
TSYDRSLFPLNISIMLNSRMISSNVAYAIQFEWNLNASESPEKQHMTLTTSPFFFSY
IIEDDN.**

1.16: Serotype 35 fiber protein

**SCSCPSAPTIFMLLQMKRARPSEDTFNPVYPYEDESTSQHPFINPGFISPNGFTQ
SPDGVLTCLKCLPLTTTGGSLQLKVGGLTVDDTDGTLQENIRATAPITKNNHSV
ELSIGNLETQNNKLCAGLNGLKFNNGDICIKDSINTLWTGINPPPNCQIVENTN
TNDGKLTLLVVKNGGLVNGYVSLVGVSDTVNQMFQKTANIQLRLYFDSSGNL
LTEESDLKIPLKNKSSSTATSETVASSKAFMPSTTAYPFNTTTRDSENYIHGICYM
TSYDRSLFPLNISIMLNSRMISSNVAYAIQFEWNLNASESPESNIMTLTTSPFFFSY
TEDDN.**

1.17 Serotype 36 fiber protein

**SCSCPSAPTIFMLLQMKRARPSEDTFNPVYPYGYARNQNIPFLTPPFVSSDGFK
NFPPGVLSLKLADPIAVNGDVSLKVGGLTVEQDSGKLVNPKIPLQVNDQLE
LATDKPFKIENKALDVGHGLKVIDKTISDLQGLVGKLVVLTGVGIGTETLKDK
NDKVGSAVNVRLGKDGGLDFNKKGDLVAWNR YDDRRTLWTTDPDPSNCKVS
EAKDSKLTLLVTKCGSQILASVALLIVKGYQTISESTIPKDQRNFSVKLMFDEKG
KLLDKSSLDKEYWNFRSNDVVGTA YDNAVPFMPNLKAYPKNTTTSSTNPDDKI
SAGKKNIVSNVYLEGRVYQPVALTVKFNSENDCAYSITFDVWSKTYESPVAFD
SSSFTFSYIAQE.**

1.18 Serotype 37 fiber protein

**SCSCPSAPTIFMLLQMKRARPSEDTFNPVYPYGYARNQNIPFLTPPFVSSDGFK
NFPPGVLSLKLADPITITNGDVSLKVGGLTLQDGLTVNPKAPLQVNTDKKLEL
AYDNPFESSANKLSLKVGHGLKVLDEKSAAGLKDLIGKLVVLTGKGIGTENLEN
TDGSSRGIGINVRAREGLTFDNDGYLVAWNPKYDLRTLWTTDPDTPNCTIAQDK
DSKLTLLVTKCGSQILANVSLIVVAGKYHIINNKTNPKIKSFTIKLLFNKNGVLLD
NSNLGKAYWNFRSGNSNVSTAYEKAIGFMPNLVAVSKPSNSKKYARDIVYGNLY
LGGKPDQPGVIKTTFNQETGCEYSITFNFSWSKTYENVEFETTSFTFSYIAQE.**

1.19 Serotype 38 fiber protein

**SCSCPSAPTIFMLLQMKRARPSEDTFNPVYPYGYARNQNIPFXTPPFVXSDGFQ
NFPPGVLSLKLADPITIANGNVSLKVGGLTLEQDSGKLIVNXXKAPLQVANDKLE
LSYADPFETSANKLSLKVGHGLKVLDEKNAGGLKDLIGTLVVLTGKGIGVEELK
NADNTNRGVGINVRLGKDGGLSFDKKGDXVAWKNHDDRRTLWTTDPDPSNCTI
DEERDSKLTLLVTKCGSQILANVSLVVKGKFSNINNNTNPTDKKITVLLFNEK
GVLMDSSSLKKEYWNYRNDNSTVSA YDNAVPFMPNIKAYPKPTTDTSAKPED
KKSAAKRYIVSNVYIGGLPDKTVVITIKLNAETESAYSMTFEFTWAKTFENLQFD
SSSFTFSYIAQE.**

Figure 7 cont.

1.20 Serotype 39 fiber protein

IRISSSLPPLSPPMDSKTSPLGCIYHSNWLTQSPSPMGMSHSRWEGGSPWQEGTG
DLKVNAKSPQLQVATNKQLEIALAKPFEEKDGLKALKIGHGLAVVDENHTHLQSL
IGTLVILTGKIGTGRAESGGTIDVRLGSGGGLSFDKDGNLVAWNKDDDRRTLW
TTPDPSPNCKIDQDKDSKLTFLVLTCKGSQILANMSLLVVKGKFSMINNKVNGTD
DYKKFTIKLLFDEKGVLLKDSSLDKEYWNYRSNNNNVGSAYEEAVGFMPSTTA
YPKPPTPTNPTTPLEKSQAKNKYVSNVYLGGQAGNPVATTVSFNKETGCTYSIT
FDFAWNKTYENVQC.

1.21: Serotype 42 fiber protein

SCSCPSAPTIFMLLQMKRARPSEDTFNPVYPYGYARNQNIPFLTPPFVSSDGFK
NFPPGVLSLKLANPIAITNGDVSLKVGGGLTLQDGTGKLTIDTKTPLQVANNKLE
LAFDAPLYEKNGKLALKTGHGLAVLTKDIGIPELIGSLVILTGKIGTGTVAGGGT
IDVRLGDDGGLSFDKKGDLVAWNKKNDRRTLWTTTPDPSPNCRVSEDKDSKLTLI
LTKCGSQLASFLLVXGTYTTVDKNTTNKQFSIKLLFDANGKLSSENLSGYW
NYRSDNSVVSTPYDNAVPFMPNTTAYPKIINSTDPENKKSSAKKTIVGNVYLEG
NAGQPVAVAISFNKETTADYSITFDFAWSKAYETPVPFDTSSMTFSYIAQE.

1.22: Serotype 43 fiber protein

NIPXLTPPFVSSDGFKNFPPGVLSLKLADPITITNGDVSLKVGGGLTVEKESGNLT
VNPKAPLQVAKGQLELAYDSPFDVKNMMLTLKAGHGLAVVTKDNTDLQPLMG
TLVVLTGKIGTGTSAHGGTIDVRIGKNGSLAFDKDGDVAWDKENDRRRTLWT
TPDTSPNCKMSEAKDSKLTLLTKCGSQLGSVSLAVKGEYQNMTANTKKNVKI
TLLFDANGVLLAGSSXXKEYWNFRSNDSTVSGNYENAVQFMPNITAYKPTNSKS
YARSVIFGNVYIDAKPYNPVVVIKISFNQETQNNCVYSISFDYTLKDYPNMQFDV
TLS

1.23: Serotype 44 fiber protein

NIPFLTPPFVSSDGQNFPPGVLSLKLADPITITNGNVSLKVGGGLTLQEGTGDLK
VNAKSPQLQVATNKQLEIALAKPFEEKDGLKALKIGHGLAVVDENHTHLQSLIGTL
VILTGKIGTGSAESGGTIDVRLGSGGGLSFDKDGNLVAWNKDDDRRTLWTTTPD
PSPNCKIDQDKDSKLTFLVLTCKGSQILANMSLLVVKGKFSMINNKVNGTDDYKK
FTIKLLFDEKGVLLKDSSLDKEYWNYRSNNNNVGSAYEEAVGFMPSTTAYPKPP
TPPTNPTTPLEKSQAKNKYVSNVYLGGQAGNPVATTVSFNKETGCTYSITFDFA
WNKTYENVQFDSSF

1.24: Serotype 45 fiber protein

NIPFLTPPFVSSDGQNFPPGVLSLKLADPIAITNGDVSLKVGGGLTVEKDSGNLK
VNPKAPLQVTTDKQLEIALAYPFEVSNGKLGKAGHGLKVIDKIAGLEGLAGTLV
VLTGKIGITENLENSDGSSRGVGINVRLAKDGVLAFDKKGDLVAWNKHDDRRT
LWTTTPDPSPNCTIDQERDSKLTLLVLTCKGSQILANVSLLVVKGKFSNINNNANPT
DKKITVKLLFNEKGVLMDSSTLKKEYWNYRNDNSTVSQAYDNAVPFMPNIKAY
PKPSTDTSAKPEDKKSAAKRYIVSNVYIGGLPDKTVVITIKFNAETECAYSITFEFT
WAKTFEDVQCDSSSFT

1.25: Serotype 46 fiber protein

Figure 7 cont.

NIPFLTTPPFVSSDGFKNFPPGVLSLKLADPIAIVNGDVSLKVGGLTLQEGNLTVD
AKAPLQVANDNKLELSYADPFVVKDTKLQKLVGHGLKVIDEKTSSGLQSLIGNL
VVLTKGKIGTQELKDKDDETKNIGVGINVRIGKNESLAFDKDGNLVAWDNENDR
RTLWTTTPDTSSKFVKISTEKD SKLTLVLTKCGSQILASVSLLA VAGSYLNMTAST
QKSIKVS LMFDSKGLLMTTSSIDKGYWNYRNKNSVVGTA YENAIPFMPNLVAYP
RPNTPD SKIYARSKIVGNVYLAGLAYQPIVITV SFNQEKDASCAYSITFEFA WNKD
YVGQFD TTSFT

1.26 Serotype 47 fiber protein

SCPSAPTIFMLLQMKRARPS EDTFNPVYPYGYARNQNIPFLTTPPFVSSDGFKNF
PPGVLSLKLADPITITNGDVSLKVGGLTLQEGTGNLTVNAKAPLQVADDKKLE
LSYDNPFEVSANKLSLKVGHGLKVLDEKNSGGLQELIGKLVILTKGKIGVEELKN
ADNTNRGVGINVRLGKDGGLSFDKKGELVAWNKHNDTRTLWTTTPDPSPNCKIE
QDKD SKLTLVLTKCGSQILATMAFQVVKGT YENISKNTAKKSFSIKLLFDDNGKL
LEGSSLDKDYWNFRNDDSIMPNQYDNAVPFMPNLKAYPNPKTSTVLPSTDKKS N
GKNTIVSNLYLEGKAYQPVAVTITFNKETGCTYSITFEFGWAKTYDVPIPFDSSSF
TFSYIAQE.

1.27: Serotype 48 fiber protein

SDIPFLTTPPFVSSDGFQNFPPGVLSLKLADPITITNGNVSLKVGGLTLQEGTGDLK
VNAKSPLQVATNKQLEIALAKPFEEKDGKLALKIGHELAVVDENLTHLQSLIGTL
VILTKGKIGTGRAESGGTIDVRLGSGGGLSFDKDGNLVAWNKDDDRRTLWTTTPD
PSPNCKIDQDKD SKLTFVLTKCGSQILANMSLLVVKGKFSMINNKVNGTDDYKK
FTIKLLFDEKGVLLKDSSLDKEYWNYRSNNNNVGSAYEEAVGFMPSTTAYPKPP
TPPTNPTTPEKSQAKNKYVSNVYLG GQAGNPVATTVSFNKETGCTYSITFDFA
WNKTYKMAFIPRFNF

1.28: Serotype 49 fiber protein

SCSCPSAPTIFMLLQMKRARPS EDTFNPVYPYGYARNQNIPFLTTPPFVSSDGFQ
NFPPGVLSLKLADPIAITNGNVSLKVGGLTVEQDSGNLKVNP KAPLQVATDNQ
LEISLADPFVKNKLSLKVGHGLKVIDENISTLQGLLGNLVVLTKGMGIGTEELK
KDDKIVGSAVNVRLGQDGGLTFDKKGD LVAWNKENDRRRTLWTTTPDPSPNCKVS
EEKD SKLTLVLTKCGSQILASVSLLVVKGKFANINNKTNPGEDYKXFSVKLLFDA
NGKLLTGSSLDGNYWNYKNKDSVIGSPYENAVPFMPNSTAYPKIINNGTANPED
KKSAAKKTIVTNVYLG GDAAKPVATTISFNKETESNCVYSITFDFA WNKTYKNV
PFDSSSLTFSYIAQE.

1.29.: Serotype 51 Fiber protein

SCSCPSAPTIFMLLQMKRARPS EDTFNPVYPYEDESTSQHPFINPGFISPNGFTQ
SPDGVLTNLCLTPLTTTGGPLQLKVGGLLIVDDTDGTLQENIRVTAPITKNNHSV
ELSIGNLETQNNKLC AKLGNGLKFNNGDICIKDSINTLWTGIKPPPNCQIVENTD
TNDGKLT LVLVKNGLVNGYVSLVGVSDTVNQMF TQKSATIQLRLYFDSSGNLL
TDES NLKIPLKNKSSSTATSEAA TSSKAFMPSTTAYPFNTTTRDSENYIHGICYMT
SYDRSLVPLNISIMLNSRTISSNVAYAIQFEWNLNAKES PESNIATLTTSPFFFSYIIE
D TTKCISLCYVSTCLFFN

Figure 8 : Radioactivity in rat organs after iv administration of radiolabeled adenovirus

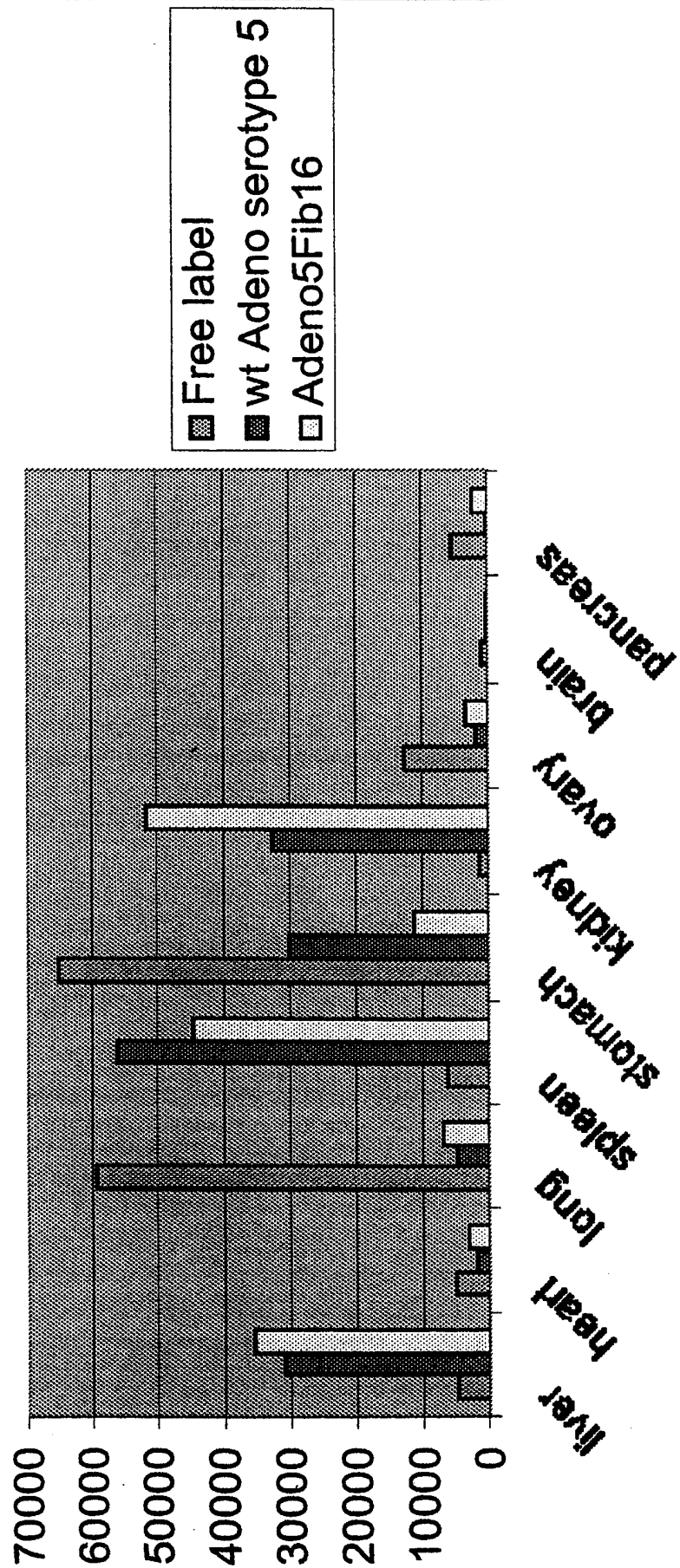

Figure 8

Figure 9

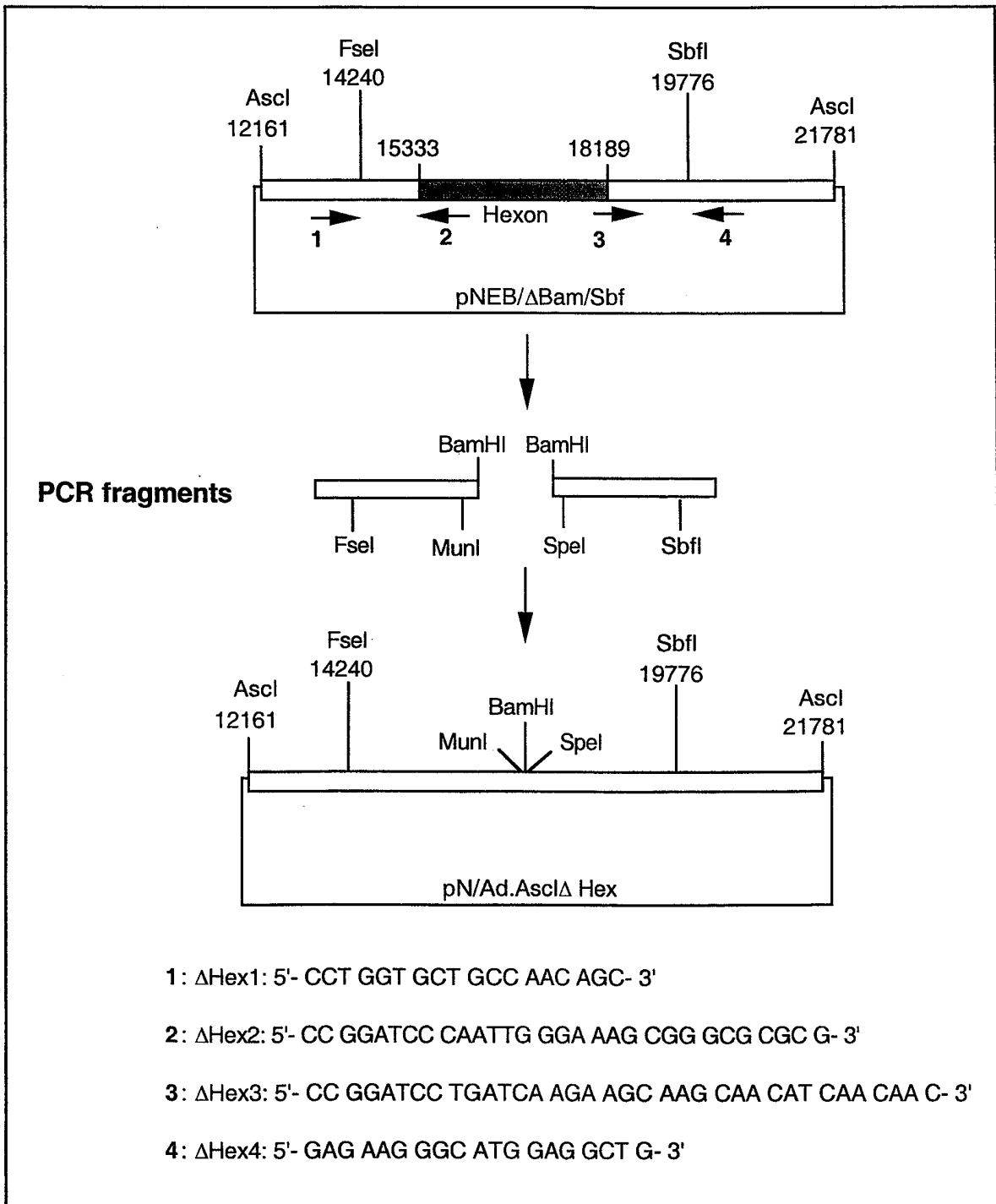

Figure 10

1.1: Serotype 34 hexon protein

LSRRAPGFPLVKMATPSMLPQWAYMHIAGQDASEYLSPLVQFARATDTYFNL
GNKFRNPTVAPTHDVTDRSQRLMLRFVPVDREDNTYSYKVRVYTLAVGDNRVL
DMASTFFDIRGVLDGRGPSFKPYSGTAYNSLAPKGAPNASQWLDKGVSTSTGLVDD
GNTDDGEEAKKATYTFGNAPVKAEEITKDGLPVGLEVSTEGPKPIYADKLYQP
EPQVGDETWTDLGKTEEYGGRVLPETKMKPCYGSFAKPTNIKGGQAKVKPK
EDDGTNIEYDIDMNFDDLRSQRSELKPKIVMYAENVLDLECPDTHVVYKPGVSD
ASSETNLGQQSMPNRPNYIGFRDNFIGLMYYNSTGNMGVLAGQASQLNAVVDL
QDRNTELSYQLLDSLDRTRYFSMWNQAVDSYDPDVRVIENHGVEDELPNYCF
PLDGVGPRTDSYKEIKPNGDQSTWTNVDPTGSSELAAGNPFAMEINLQANLWRS
FLYSNVALYLPDSYKYTPSNVTLPENKNTYDYMNGRVPPSLVDTYVNIGARWS
LDAMDNVNPFNHHRNAGLRYSMLLGNGRYVPPFHIQVPQKFFAVKNLLLLPGS
YTYEWNFRKDVNMVLQSSLGNDLRVDGASISFTSINLYATFFPMAHNTASTLEA
MLRNDTNDQSFNDYLSAANMLYPIANATNIPISIPSRNWAAPFRGWSFTRLKTKKE
TPSLGSGFDPYFVYSGSIPLDGTFFYLNHTFKKVSIMFDSSVSWPGNDRLLSPNEFEI
KRTVDGEGYNVAQCNMTDWFLVQMLANYNIGYQGFYIPEGYKDRMYSFFRNF
QPMSRQVVDEVNYKDFKAVIPYQHNNSGFVGYMAPTMRQGQPYPANYPYPLIG
TTAVNSVTQKKFLCDRTMWRIPFSSNFMSMGALDLDGQNMLYANSAHALDMTF
EVDPMDEPTLLYLLFEVFDVVRVQPHRGIIAVLRTPPFSAGNATT.

1.2: Serotype 35 hexon protein

LSRRAPGFPLVKMATPSMLPQWAYMHIAGQDASEYLSPLVQFARATDTYFNL
GNKFRNPTVAPTHDVTDRSQRLMLRFVPVDREDNTYSYKVRVYTLAVGDNRVL
DMASTFFDIRGVLDGRGPSFKPYSGTAYNSLAPKGAPNASQWLDKGVSTSTGLVDD
GNTDDGEEAKKATYTFGNAPVKAEEITKDGLPVGLEVSTEGPKPIYADKLYQP
EPQVGDWTDLGKTEEYGGRVLPETKMKPCYGSFAKPTNIKGGQAKVKPKKE
DDGTNNIYDIDMNFDDLRSQRSELKPKIVMYAENVLDLECPDTHVVYKPGVSDAS
SETNLGQQMPNRPNYIGFRDNFIGLMYYNSTGNMGVLAGQASQLNAVVDLQDR
NTELSYQLLLSLGDRTRYFSMWNQAVDSYDPDVRVIENHGVEDELPNYCFPLDG
VGPRTDYKEIPNGDQSTWTNVDPTGSSELAAGNPFAMEINLQANLWRSFLYSN
VALYLPDSYKYTSNVTLPENKNTYDYMNGRVPPSLVDTYVNIGARWSLDAMD
NVNPFNHHRNAGRYRSMMLGNGRYVPPFHIQVPQKFFAVKNLLLLPGSYTYEWN
FRKDVNMVLQSSDLRVDGASISFTSINLYATFFPMAHNTASTLEAMLRNDTND
QSFNDYLSAANMLYPIANATNIPISIPSRNWAAPFRGWSFTRLKTKETPSLGSGFDP
YFVYSGSIPYLDGTFFYLHTFKKVSIMFDSSVSWPGNDRLLSPNEFEIKRTVDGEGY
NVAQCNMTKDWFLVQLANYNIGYQGFYIPEGYKDRMYSFFRNFQPMSRQVVDE
VNYKDFKAVAIQYQHNNGFVGYMAPTMRQGQPYPANYPYPLIGTTAVNSVTQK
KFLCDRTMWRIPFSSNFMSALDLDGQNMLYANSAHALDMTFEVDPMDEPTLLY
LLFEVFDVVRVHQPHRGIIAVLRTPPFSAGNATT.

1.3 Serotype 36 hexon protein

Figure 10 cont.

LSRRAPGFPLVKMATPSMLPQWAYMHIAGQDASEYLSPLGLVQFARATDTYFNL
 GNKFRNPTVAPTHDVTDRSQRMLRFVPVDREDNTYSYKVRVYTLAVGDNRVL
 DMASTFFDIRGVLDRGSPFKPYSGTAYNSLAPKGAPNASQWLDKGVSTSTGLVDD
 GNTDDGEEAKKATYTFGNAPVKAEEITKDGLPVGLEVSTEGPKPIYADKLYQP
 EPQVGDWTWDLGKTEEYGGRLKPKETKMKPCYGSFAKPTNIKGGQAKVKPKE
 DDGTNNIYDIDMNFDFLRSQRSELKPKIVMYAENVLDLECPDTHVVYKPGVSDAS
 SETNLGQQSMPNRPNYIGFRDNFIGLMYYNSTGNMGVLAGQASQLNAVVDLQD
 RNTELSYQLLDSLGDRTYFSMWNQAVDSYDPDVRVIENHGVEDELPNYCFPLD
 GVGPRTDSYKIKPNGDQSTWTNVDPGTSSELAKGNPFAMEINLQANLWRSFLYS
 NVALYLPDSYKYTPSNVTLPENKNTYDYMNGRVVPPSLVDYVNI GARWSLDA
 MDNVNPFNHHRAGLRYSMLLGNRYVPFHIQVPQKFFAVKNLLLLPGSYTYE
 WNFVKDVMVLQSLGNDLRVDGASISFTSINLYATFFPMAHNTASTLEAMLRND
 TNDQSFNDYLSAANMLYPIPANATNIPISIPSRNWA AFRGWSFTRLKTKETPSLGS
 GFDPYFVYSGSIPYDGT FYLNHTFKKVSIMFDSSVSWPGNDRLLSPNEFEIKRTVD
 GEGYNVAQCMTKWFLVQMLANYNIGYQGFYIPEGYKDRMYSFFRNFPMSR
 QVVDEVNYKDFKAVIYQHNSGFVGYMAPTMRQGQPYPANYPYPLIGTTAVNS
 VTQKKFLCDRTMWRIPFSSNFMSMGALTDLGQNMLYANSAHALDMTFEVDPM
 DEPTLLYLLFEVFDVVRVQPHRGIIEAVYLRT PFSAGNATT.

1.4: Serotype 41 hexon protein

VCVHVAARGAAEPPRARFPLVKMATPSMMPQWAYMHIAGQDASEYLSPLGLVQ
 FARATDTYFSLGNKFRNPTVAPTHDVTDRSQRMLRFVPVDREDDTYSYKARFT
 LAGDNRVLDMASTYFDIRGVLDRGSPFKPYSGTAYNSLAPKGAPNSSQWADKE
 RVNGGGNTKDVTKTFGVAAMGGEDITEKGLKIGTDTTANEPFADKNFQPEPQV
 GEENQETFVYGGRAK KETKMKPCYGSFARPTNEKGGQAKFIIGDNGQPTENH
 DITMAFDTPGGTITGGTGGPQDELKADIVMYTENINLETPTDTHVVYKPGKEDDSS
 EINLVQSMPNRPNYIGFRDNFVGLMYNSTGNMGVLAGQASQLNAVVDLQDRN
 TELS YQLLDSLGDRTYFSMWN SA VDSYDPDVR IENHGVEDELPNYCFPLD GSG
 TNSAFQGKIKQNQDGDVNDDWEKDDKVSTQNQICKGNIYAMEINLQANLWKSF
 LYSNVALYLD SYKYTPANVTLPTNTNTY EYMNGRVVAPSLVDA YINIGARWSLD
 PMDNVNPFNHRNAGLRYSNASGQRPLRALPHPSAPKVLCHQEPAPAPGLLHLR
 VELPQGRQHDAEFPRKRPARRRRLRALRQRQPLCHILPHGAQHRLHPGSHAAQR
 HQRPVLRQLPLRQHALPHPGQGHQRAHLHPLAQLGRLSRLEFHPAQDQGN SFPR
 LGFRPLLCLLGLHPLPRRDLLPQPHLQEGLHHVRLLGQLARQRPAVTPNEFEIKRS
 VDGE GYNVAQCMTKDWFLVQMLSHYNIGYQGFHVPEGYKDRMYSFFRNFPMSR
 SRQVVDEINYKDYAVTLPFQHNSGFTGYLAPTMRQGQPYPANFPYPLIGSTAVP
 SVTQKKFLCDRVMWRIPFSSNFMSMGALTDLGQNMLYANSAHALDITFEVDPM
 DEPTLLYLLFEVFDVVVHQPHRGVIEAVYLRT PFSAGNATT.