



US00D766997S

(12) **United States Design Patent**
Lee et al.

(10) **Patent No.:** **US D766,997 S**

(45) **Date of Patent:** **** Sep. 20, 2016**

(54) **COOL AIR DUCT FOR REFRIGERATOR**

(71) Applicant: **LG ELECTRONICS INC.**, Seoul (KR)

(72) Inventors: **Hangbok Lee**, Seoul (KR); **Hongsik Kwon**, Seoul (KR); **Minsub Kim**, Seoul (KR); **Jungkyu Son**, Seoul (KR); **Eugene Suh**, Seoul (KR); **Junyi Heo**, Seoul (KR)

(73) Assignee: **LG Electronics Inc.**, Seoul (KR)

(**) Term: **14 Years**

(21) Appl. No.: **29/522,092**

(22) Filed: **Mar. 27, 2015**

(30) **Foreign Application Priority Data**

Jan. 13, 2015 (KR) 30-2015-0001580

(51) **LOC (10) Cl.** **15-07**

(52) **U.S. Cl.**

USPC **D15/89**

(58) **Field of Classification Search**

USPC D15/79-91
CPC F25B 21/02; F25B 2321/02; F25B 1/005; F25B 2321/0252; F25B 1/00; F25B 1/10; F25B 21/04; F25B 2339/047; F25B 5/02; F25B 7/00; F25B 13/00; F25B 1/053; F25B 2309/06; F25B 2321/021; F25B 2321/023; F25D 23/028; F25D 23/02; F25D 25/025; F25D 23/00; F25D 2323/021; F25D 11/00; F25D 2323/024; F25D 23/04; F25D 29/00; F25D 25/02; F25D 25/024; F25D 27/005; F25D 23/12; F25D 29/005; F25D 17/042; F25D 2325/021

See application file for complete search history.

(56) **References Cited**

U.S. PATENT DOCUMENTS

4,970,874 A *	11/1990	Solak	F25D 23/00	312/116
D379,467 S *	5/1997	Martin	D15/89	
D613,315 S *	4/2010	Crookshanks	D15/89	
D709,107 S *	7/2014	Kim	D15/89	
D709,533 S *	7/2014	Park	D15/89	
D722,622 S *	2/2015	Kim	D15/89	
D724,119 S *	3/2015	Kim	D15/89	

* cited by examiner

Primary Examiner — Daniel Bui

Assistant Examiner — Khawaja Anwar

(74) *Attorney, Agent, or Firm* — Birch, Stewart, Kolasch & Birch, LLP

(57) **CLAIM**

We claim the ornamental design for a cool air duct for refrigerator, as shown and described.

DESCRIPTION

FIG. 1 is a perspective view of a cool air duct for refrigerator showing our new design;
FIG. 2 is a front elevation view thereof;
FIG. 3 is a rear elevation view thereof;
FIG. 4 is a left-side elevation view thereof;
FIG. 5 is a right-side elevation view thereof;
FIG. 6 is a top plan view thereof;
FIG. 7 is a bottom plan view thereof;
FIG. 8 is a rear perspective view thereof; and,
FIG. 9 is a partial enlarged view thereof in a state of use.
The broken lines in the drawing figures are included for the purpose of illustrating environment and form no part of the claimed design.

1 Claim, 7 Drawing Sheets

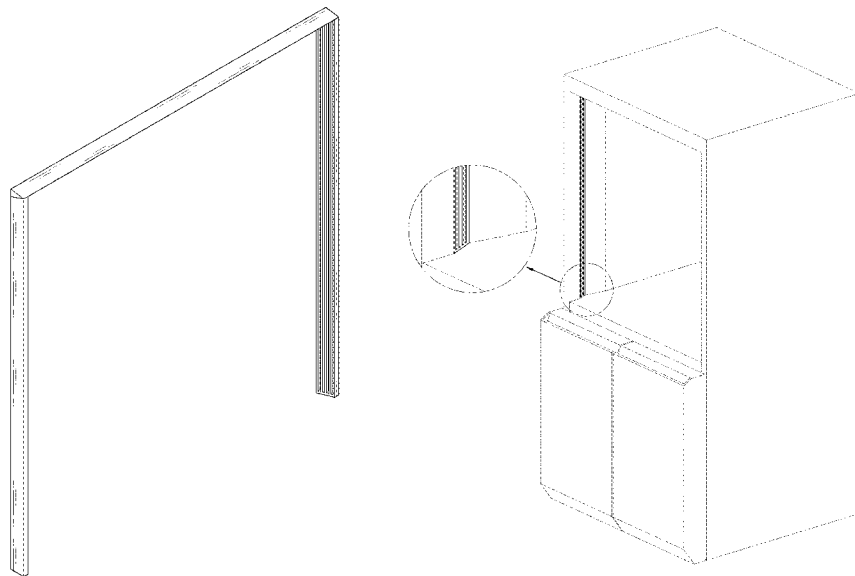

FIG. 1

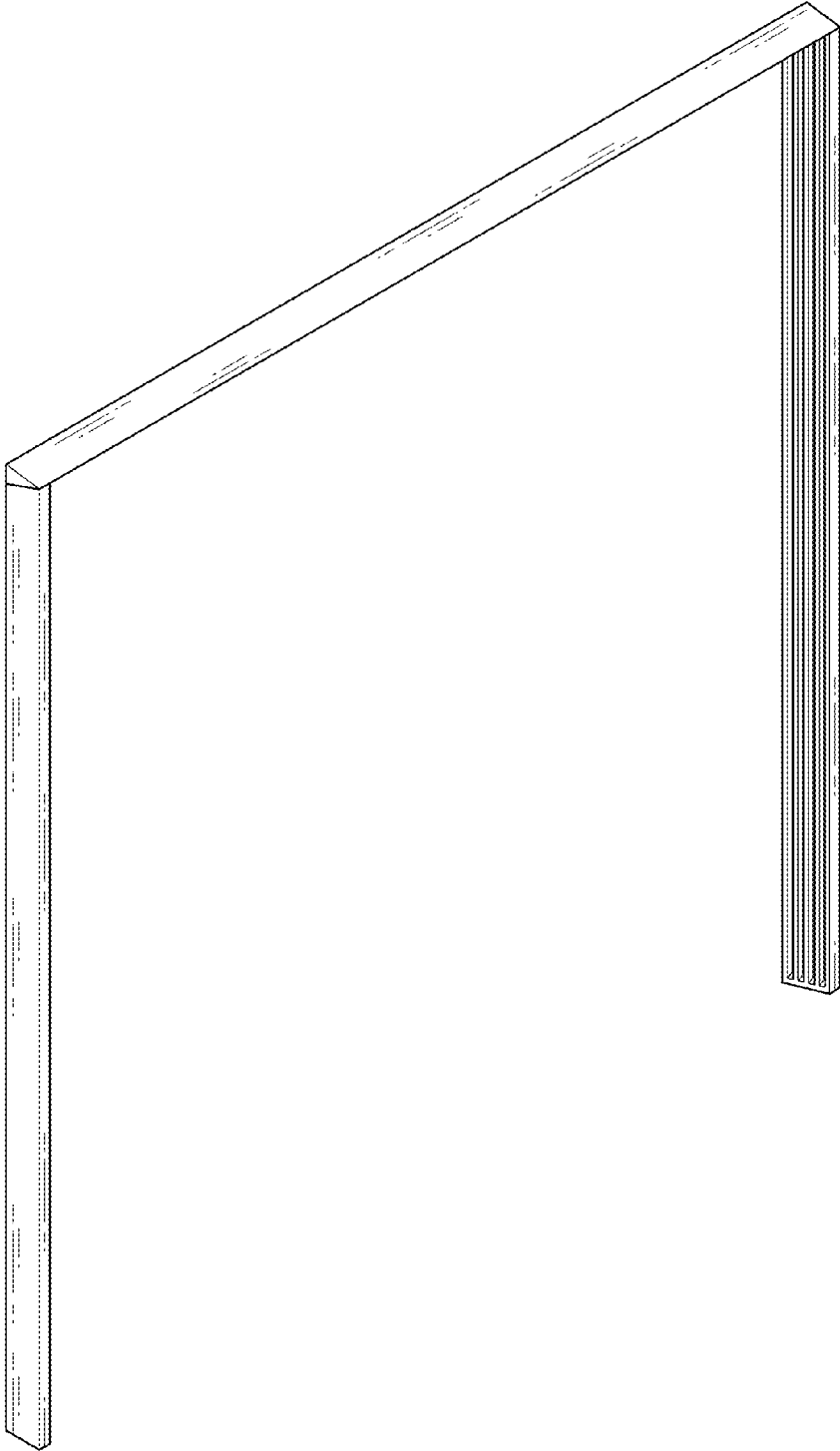

FIG. 2

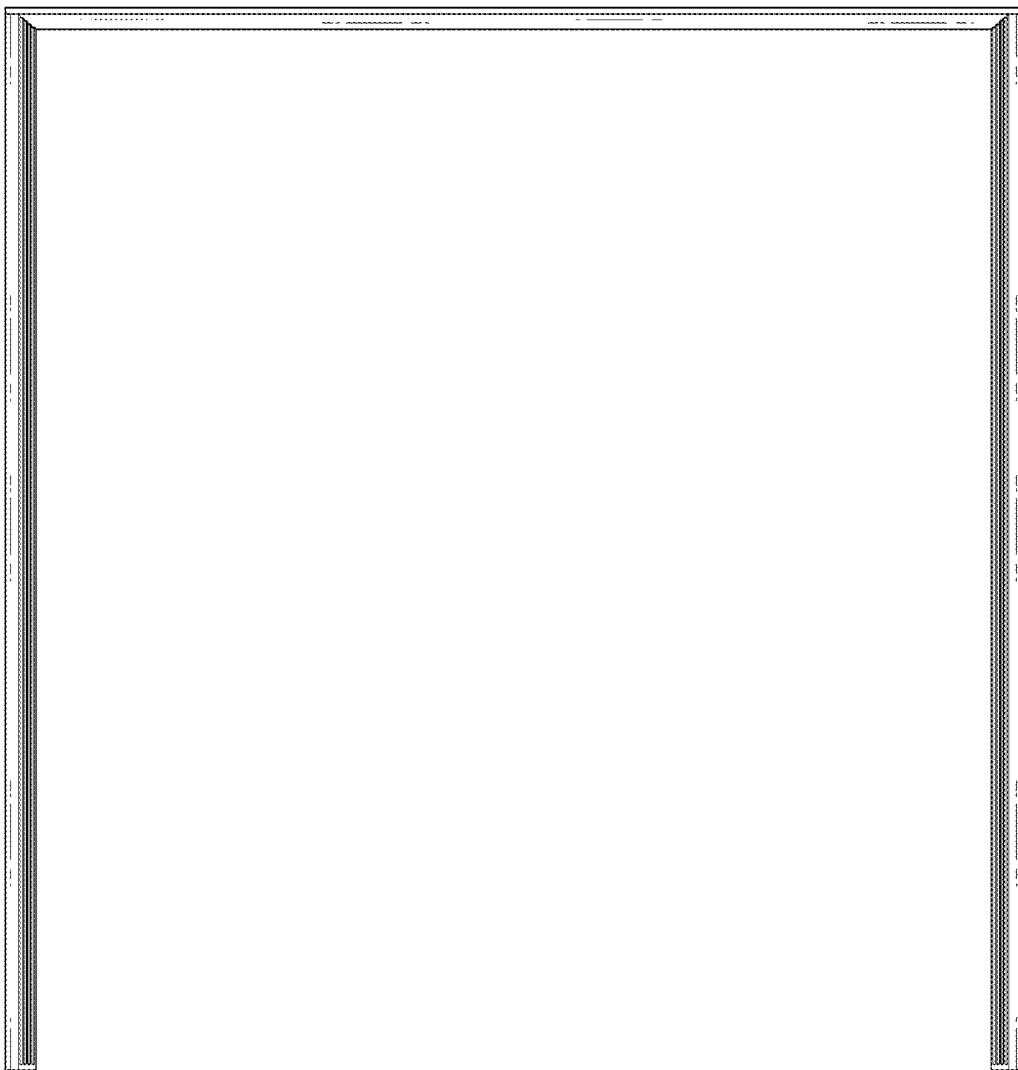

FIG. 3

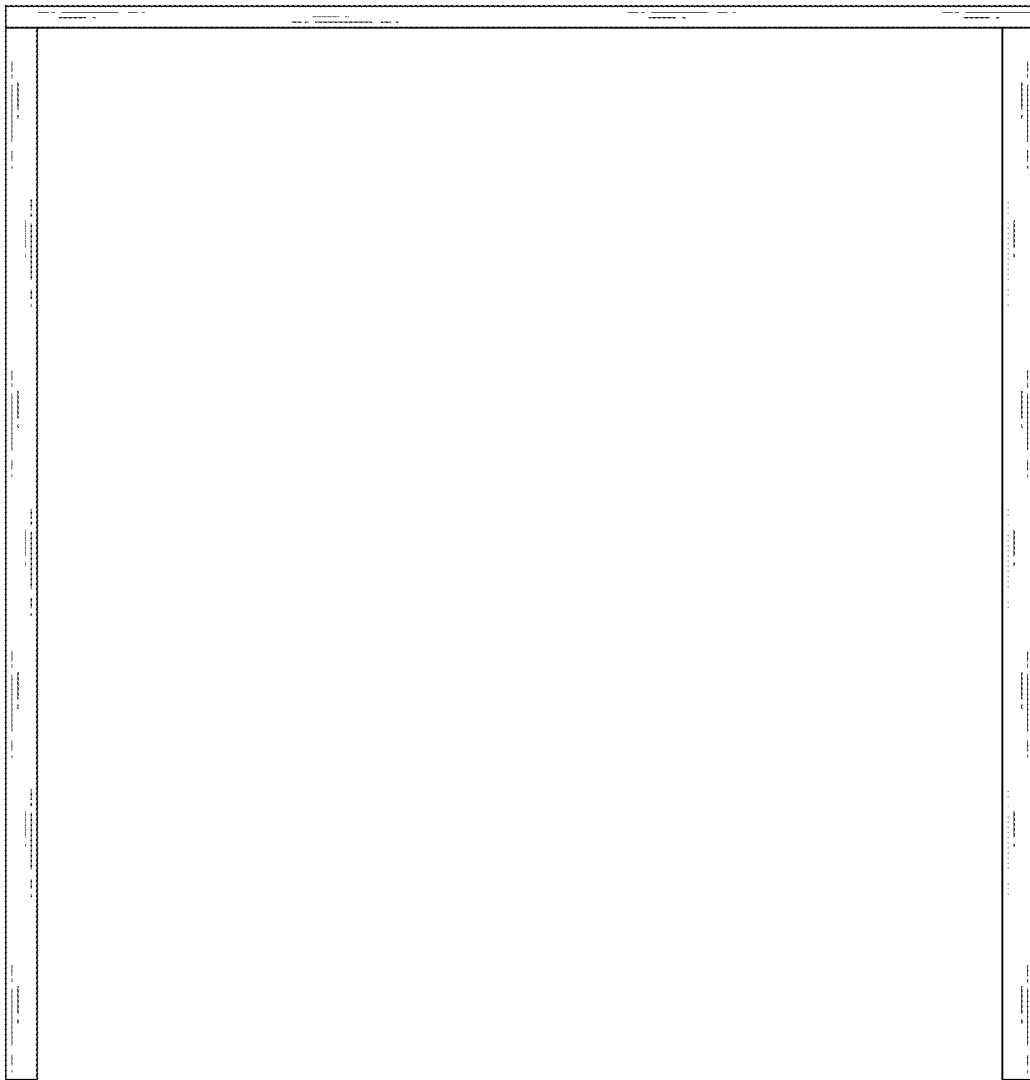

FIG. 4

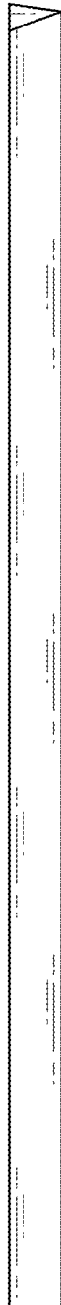

FIG. 5



FIG.6



FIG.7

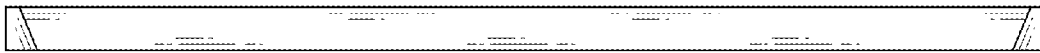

FIG. 8

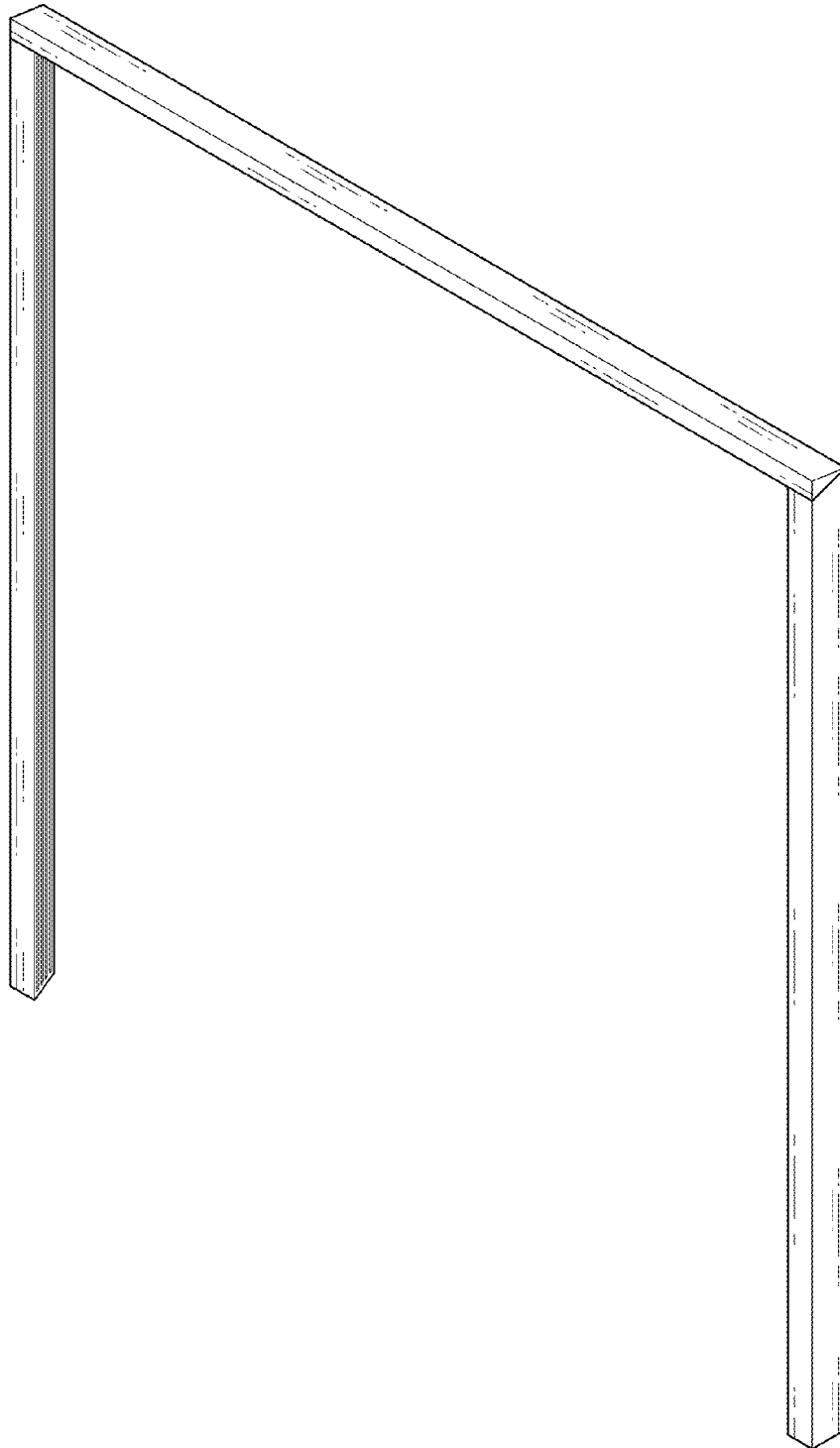

FIG. 9

