



US00D330722S

United States Patent [19]

[11] Patent Number: **Des. 330,722**

Je

[45] Date of Patent: **** Nov. 3, 1992**

[54] **MODULAR POINT OF SALE TERMINAL**

D. 294,366 2/1988 Nishibori et al. D18/4

[75] Inventor: **Patrick N. M. Je, Singapore, Singapore**

D. 295,175 4/1988 Long D18/4

D. 313,977 1/1991 Lino D14/100

[73] Assignee: **Essex Electric Pte Ltd., Singapore**

Primary Examiner—Nelson C. Holtje

Assistant Examiner—Ann Hunt

[**] Term: **14 Years**

Attorney, Agent, or Firm—Finnegan, Henderson, Farabow, Garrett & Dunner

[21] Appl. No.: **548,778**

[57] CLAIM

[22] Filed: **Jul. 6, 1990**

The ornamental design for a modular point of sale terminal, as shown and described.

[30] **Foreign Application Priority Data**

DESCRIPTION

Feb. 21, 1990 [GB] United Kingdom 2004845

[52] U.S. Cl. **D18/4; D14/105**

[58] Field of Search D18/3, 4, 6, 7, 11; D14/100, 105, 106, 112, 113; 235/1 D, 1 E, 2, 4, 7 R, 10, 12, 375, 379, 380, 419; 364/404, 405

FIG. 1 is a front perspective view of the modular point of sale terminal showing by new design;

FIG. 2 is a rear perspective view thereof;

FIG. 3 is a front elevational view thereof;

FIG. 4 is a rear elevational view thereof;

FIG. 5 is a left side elevational view thereof;

FIG. 6 is a right side elevational view thereof;

FIG. 7 is a top plan view thereof; and,

FIG. 8 is a bottom plan view thereof.

[56] **References Cited**

U.S. PATENT DOCUMENTS

D. 282,745 2/1986 Brown D14/115

D. 291,201 8/1987 Weisel, Jr. et al. D14/100

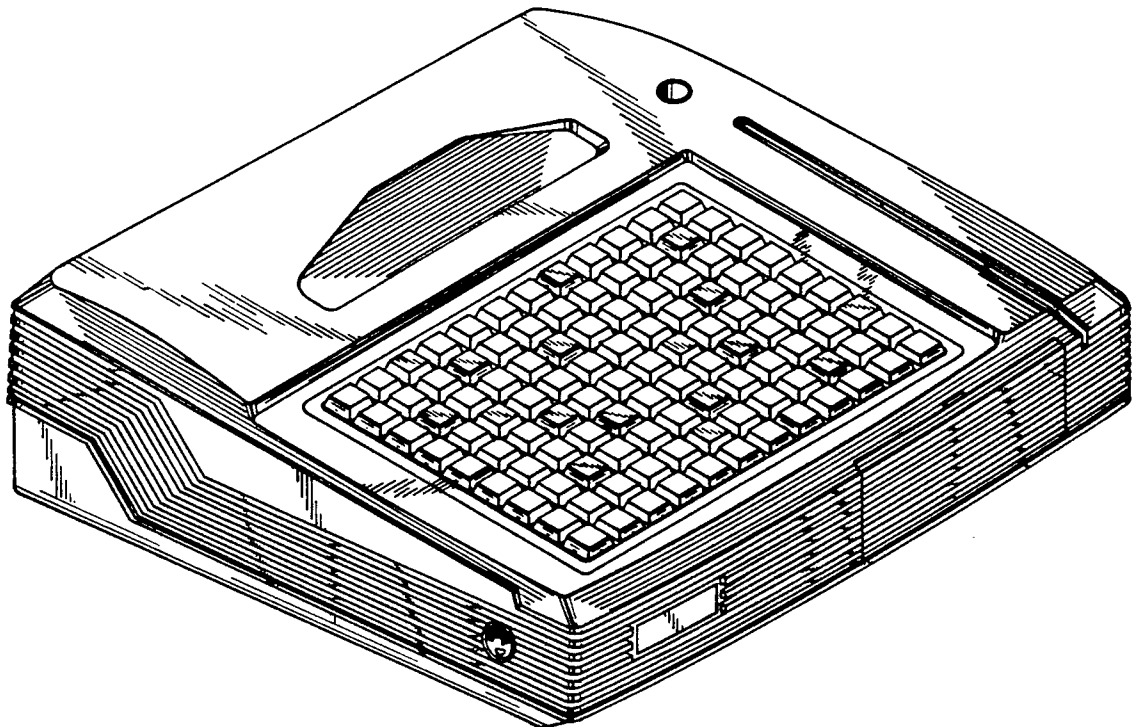

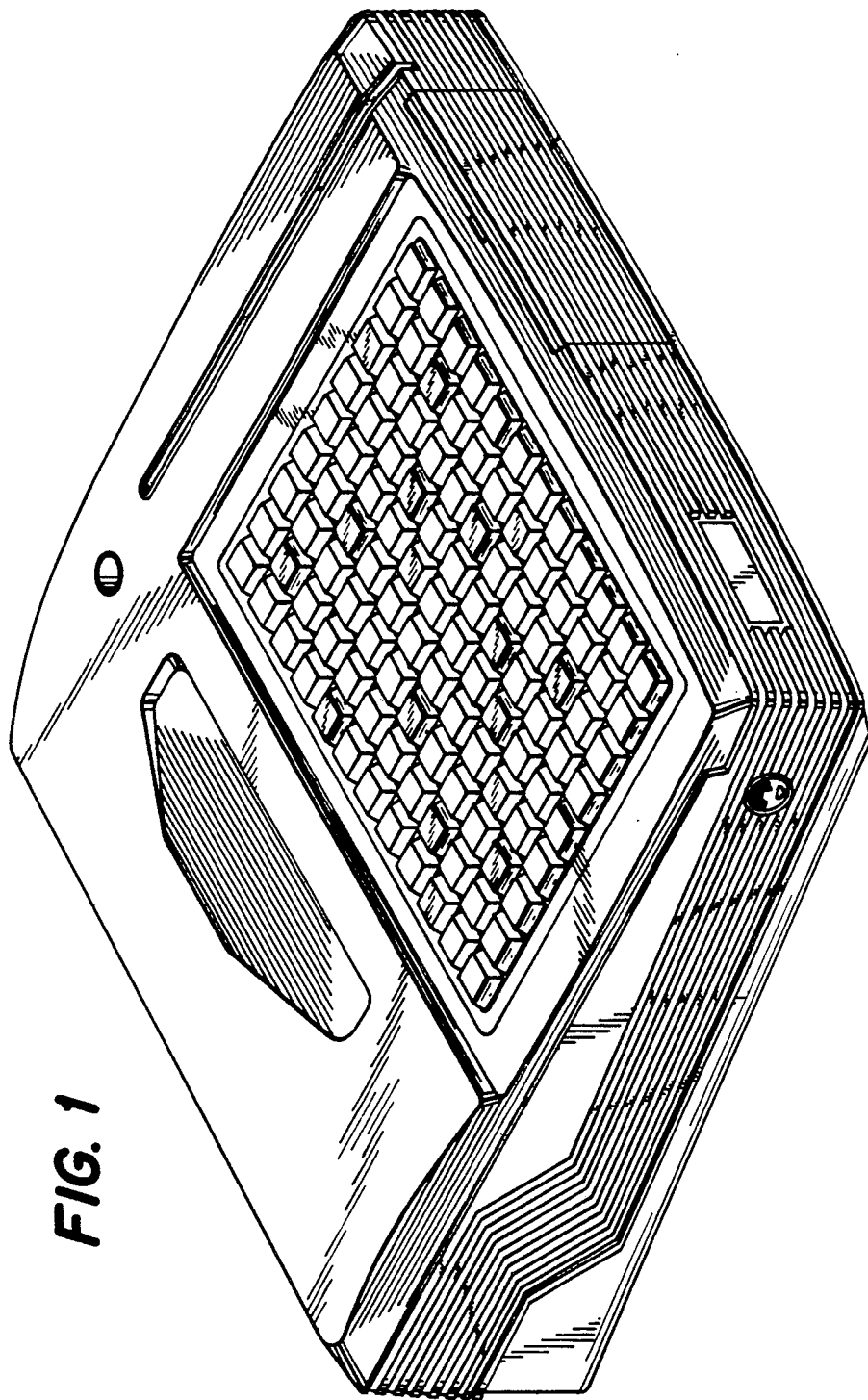

FIG. 1

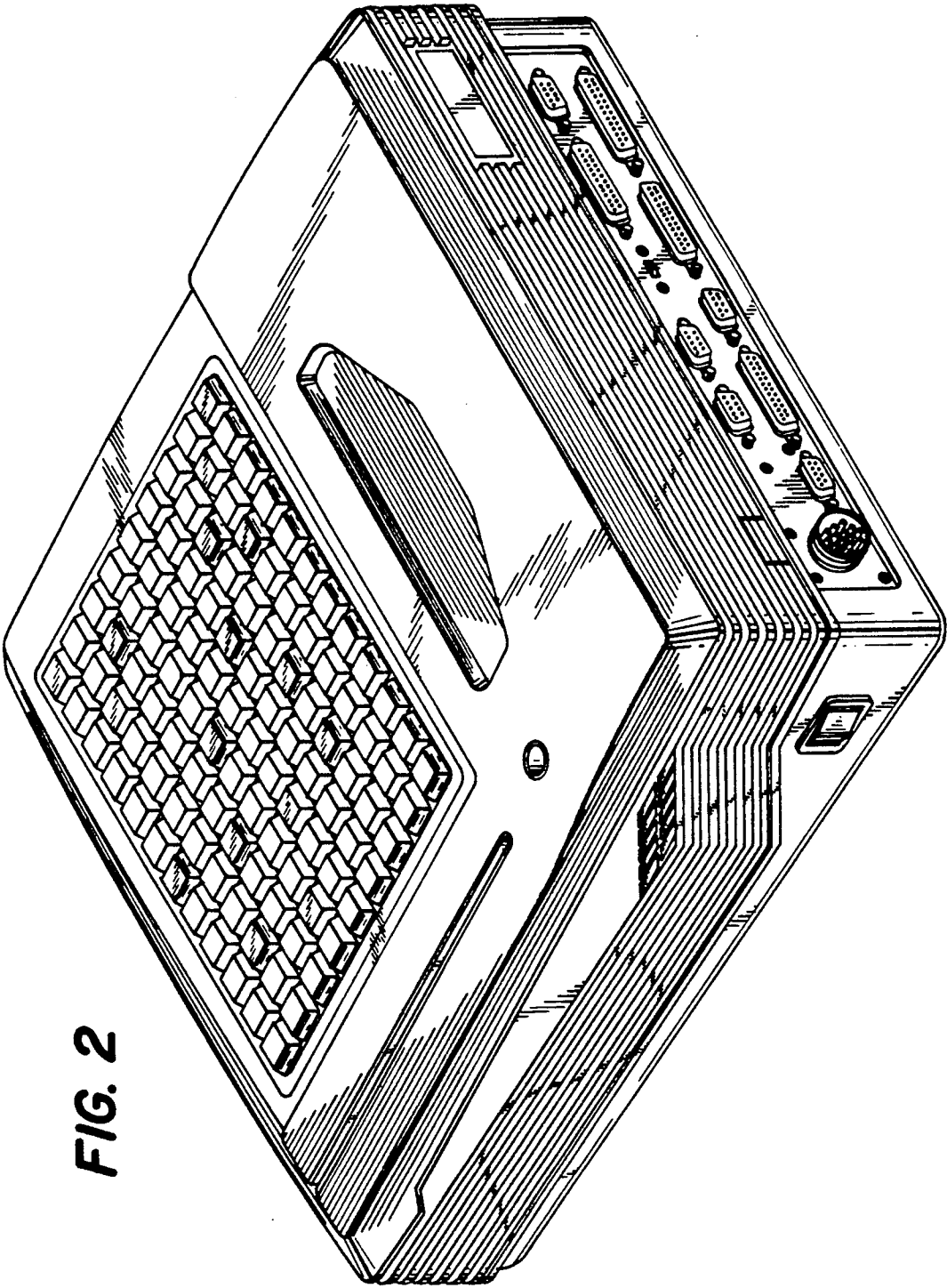

FIG. 2

FIG. 3

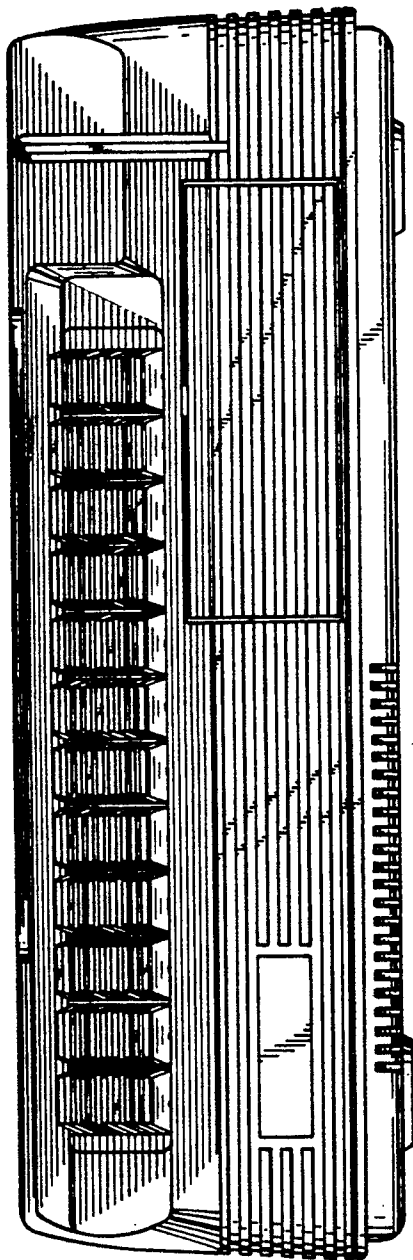

FIG. 4

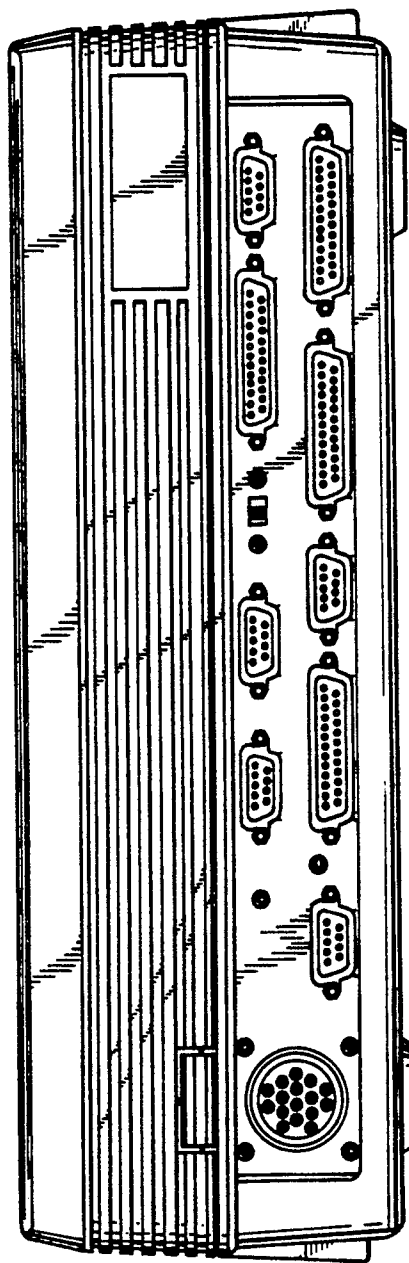

FIG. 5

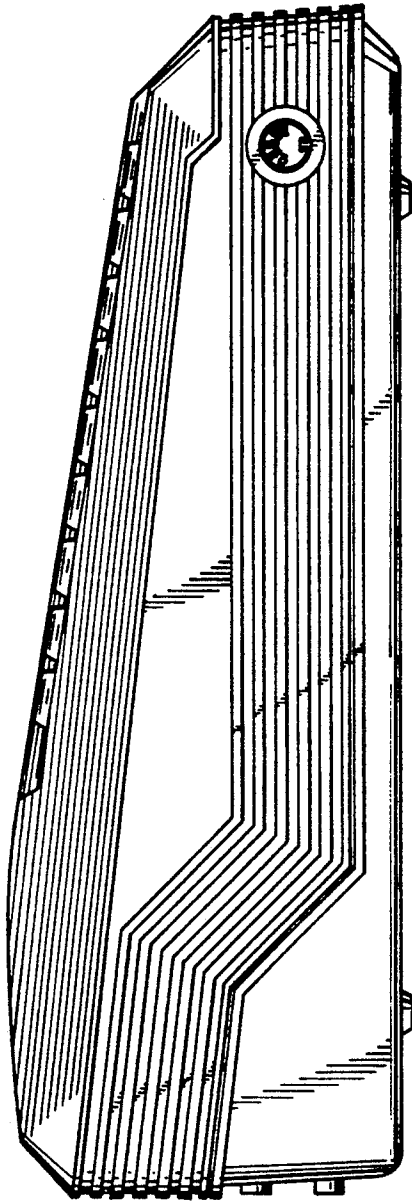
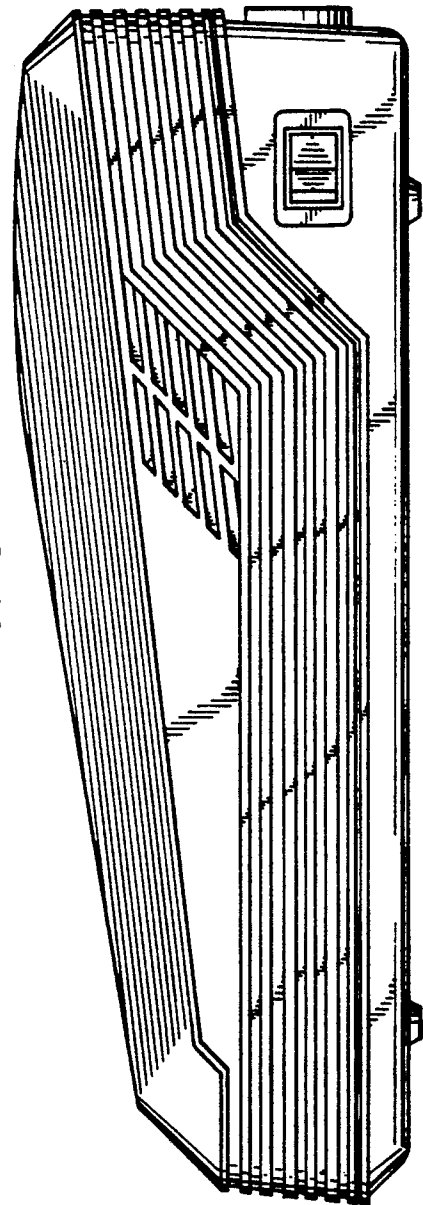

FIG. 6



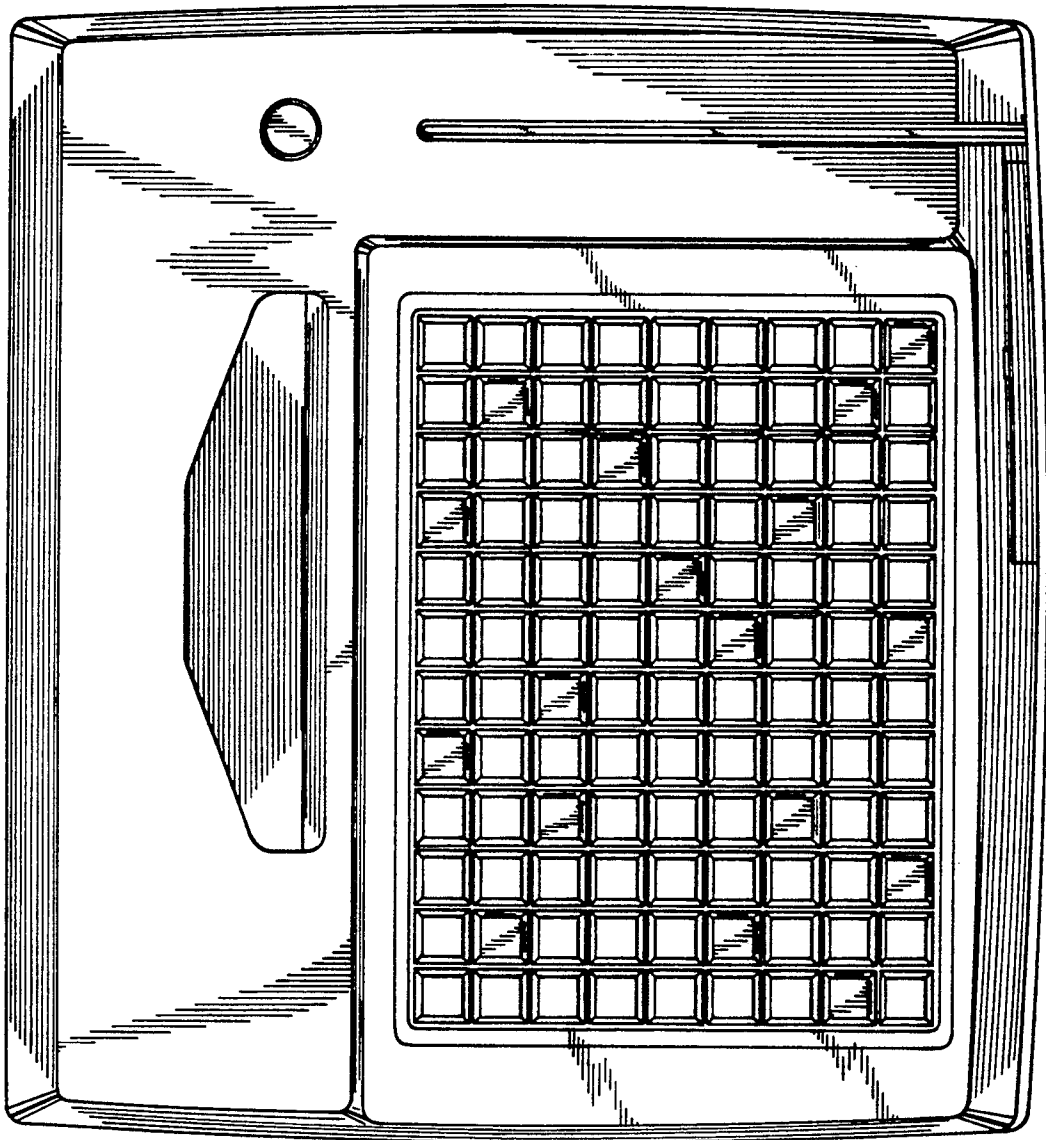

FIG. 7

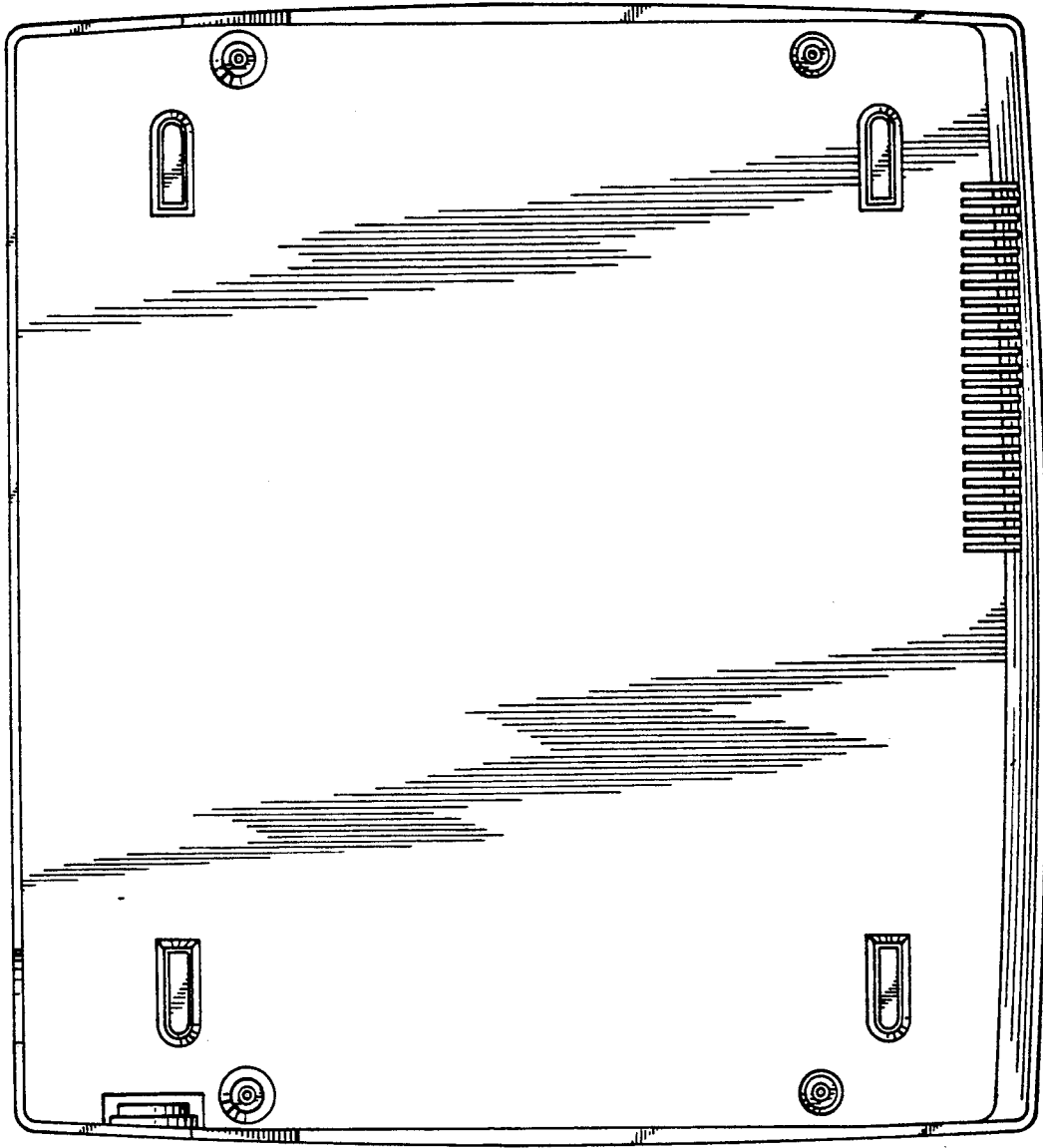

FIG. 8