



US00D378563S

**United States Patent** [19]  
**Ferris**

[11] **Patent Number: Des. 378,563**  
[45] **Date of Patent: \*\*Mar. 25, 1997**

[54] **CONTAINER FOR FOOD**  
[75] Inventor: **Ian Ferris**, Finchampstead, England  
[73] Assignee: **Dart Industries Inc.**, Deerfield, Ill.  
[\*\*] Term: **14 Years**

4,412,630 11/1983 Daenen .

*Primary Examiner*—Terry A. Wallace  
*Attorney, Agent, or Firm*—John A. Doninger

[57] **CLAIM**

The ornamental design for a container for food, as shown.

**DESCRIPTION**

[21] Appl. No.: **43,926**  
[22] Filed: **Sep. 28, 1995**  
[52] **U.S. Cl.** ..... **D7/629; D7/538**  
[58] **Field of Search** ..... D7/538-549, 586-587,  
D7/602, 629; D9/414, 424, 425, 430-432;  
220/212, 270, 306, 307, 352, 353, 355,  
574

FIG. 1 is a top, side and front perspective view of the container for food showing my new design;  
FIG. 2 is an exploded perspective view thereof;  
FIG. 3 is a top plan view thereof;  
FIG. 4 is a bottom plan view thereof;  
FIG. 5 is a front view thereof;  
FIG. 6 is a rear view thereof;  
FIG. 7 is a right side elevation view thereof;  
FIG. 8 is a left side elevation view thereof;  
FIG. 9 is an exploded right side elevation view thereof;  
FIG. 10 is a cross-section view thereof on line 10—10 in FIG. 3; and,  
FIG. 11 is a cross-section view thereof on line 11—11 in FIG. 3.

[56] **References Cited**

**U.S. PATENT DOCUMENTS**

D. 195,524	6/1963	Patton, Jr. ....	D7/587
D. 272,595	2/1984	Chase et al. ....	D7/629
D. 308,941	7/1990	Kong .	
D. 355,814	2/1995	VanValkenburg et al. ....	D7/629
D. 366,989	2/1996	Zimmerman ....	D7/629
3,384,263	5/1968	Bernstein .	

**1 Claim, 5 Drawing Sheets**

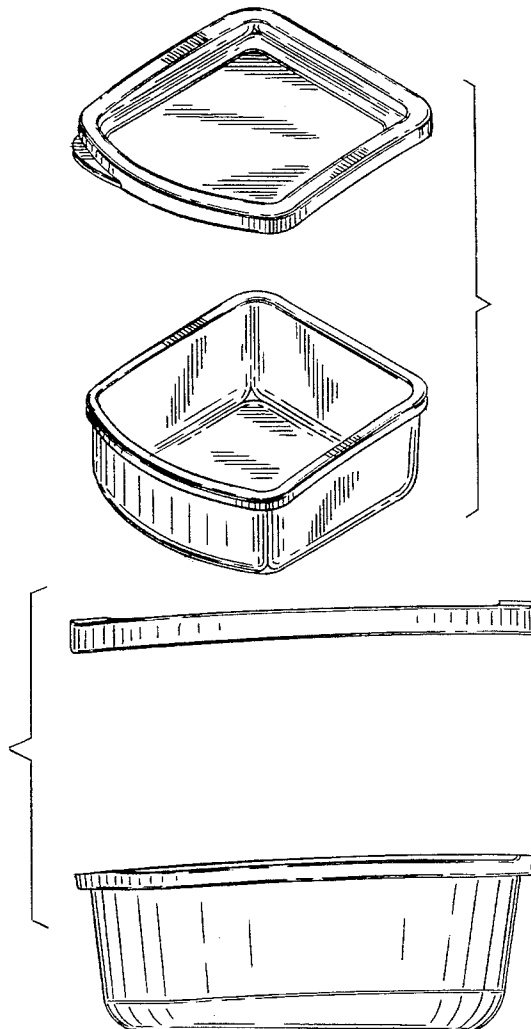

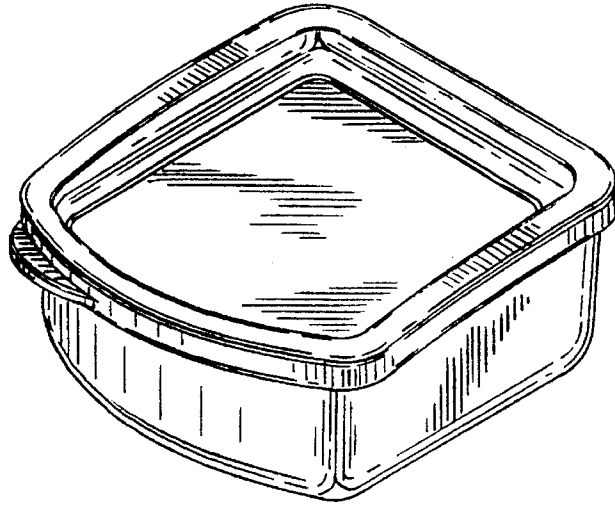

FIG. 1

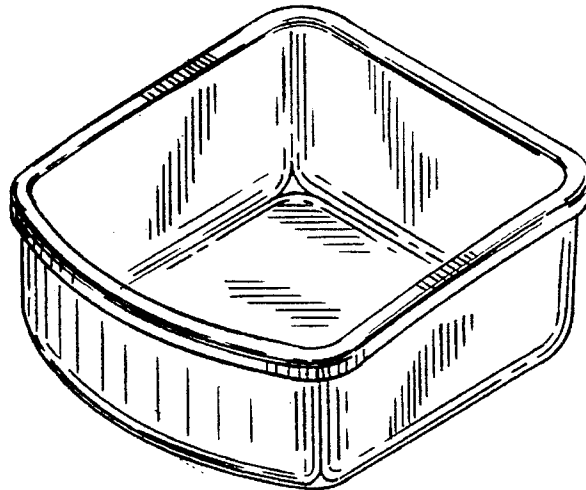
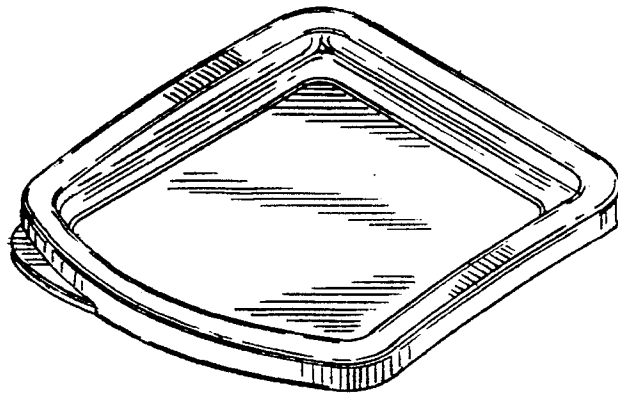

FIG. 2

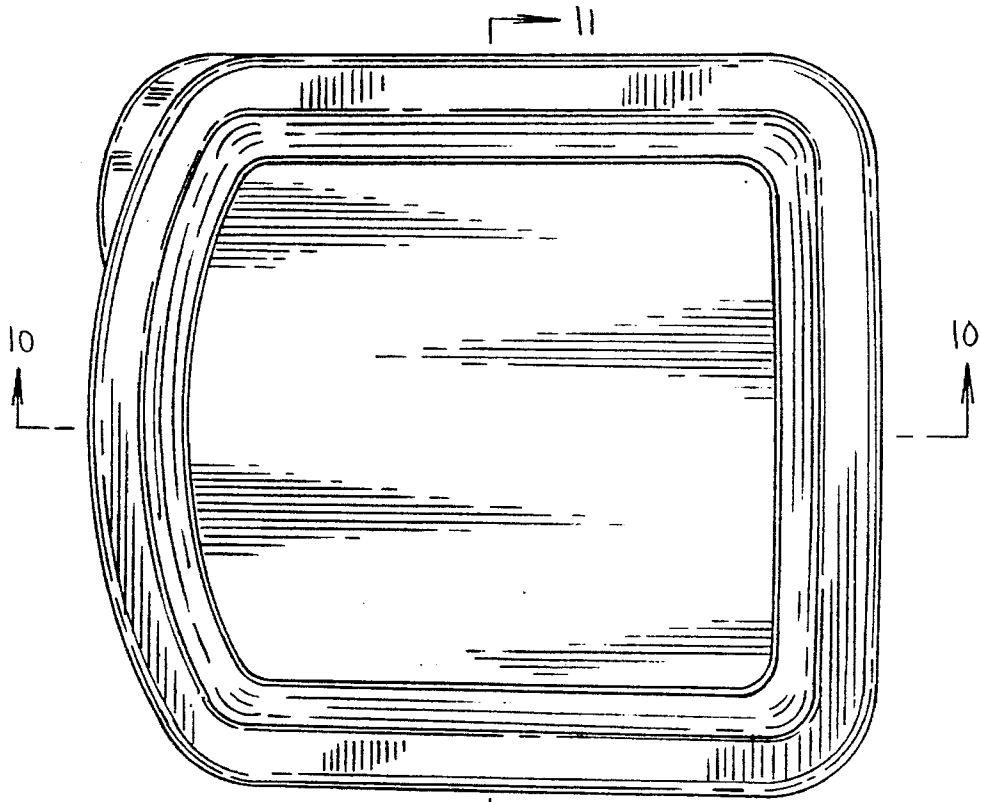

FIG. 3

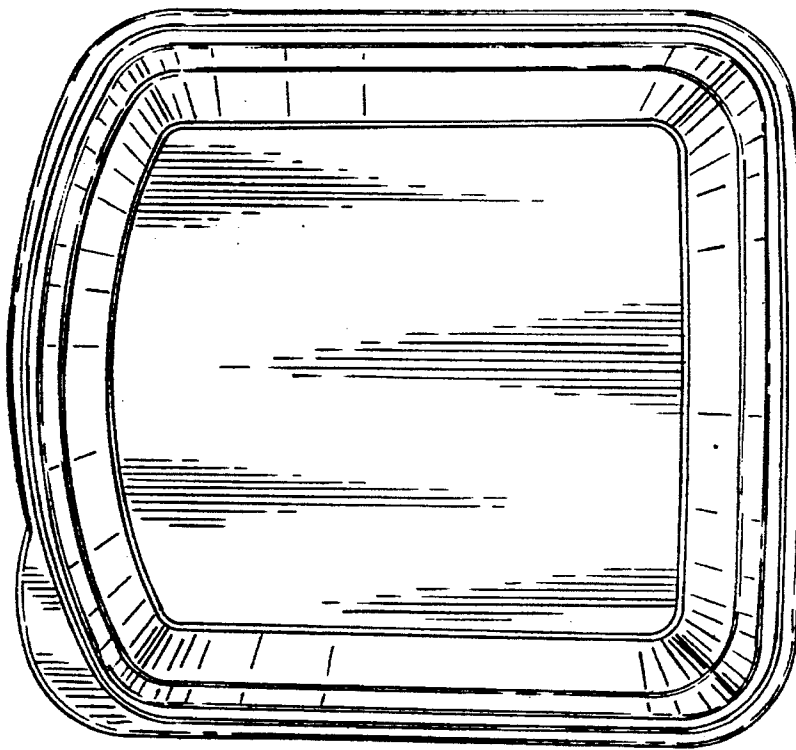

FIG. 4

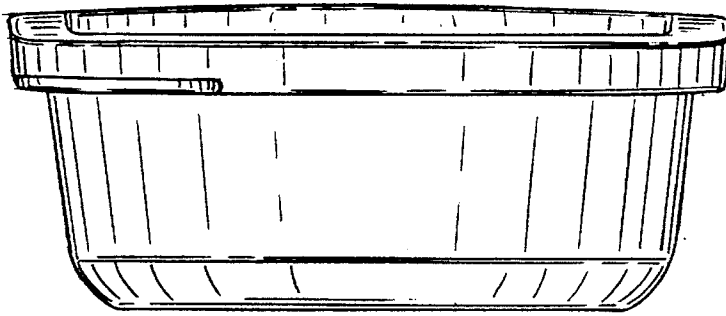

FIG. 5

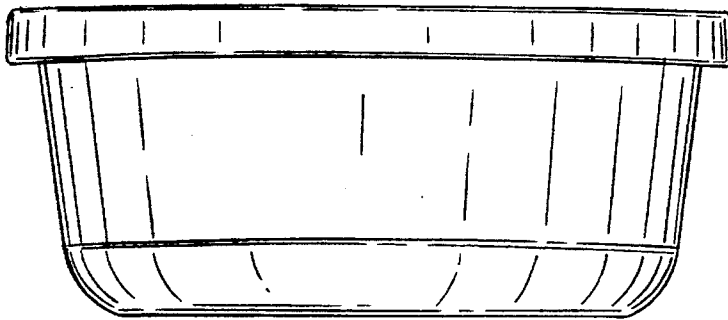

FIG. 6

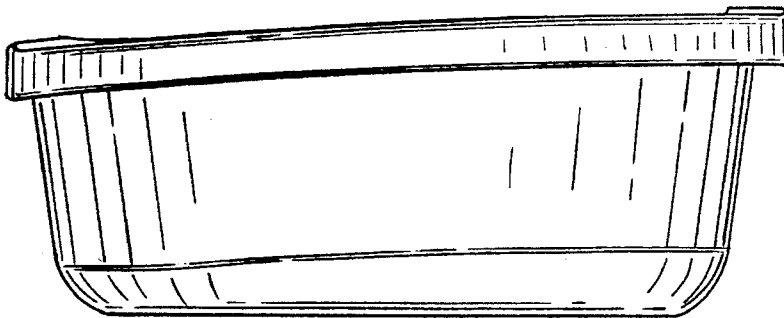
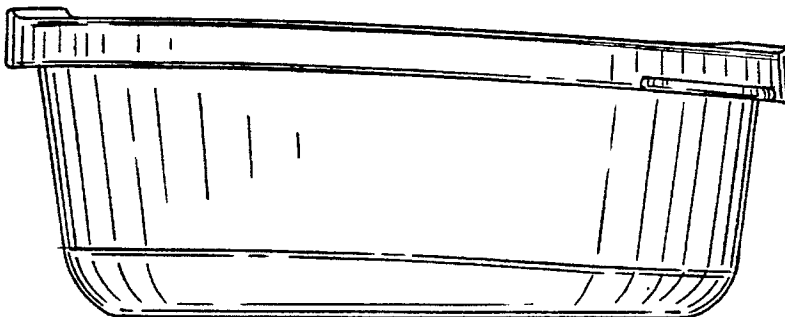

FIG. 7

FIG. 8



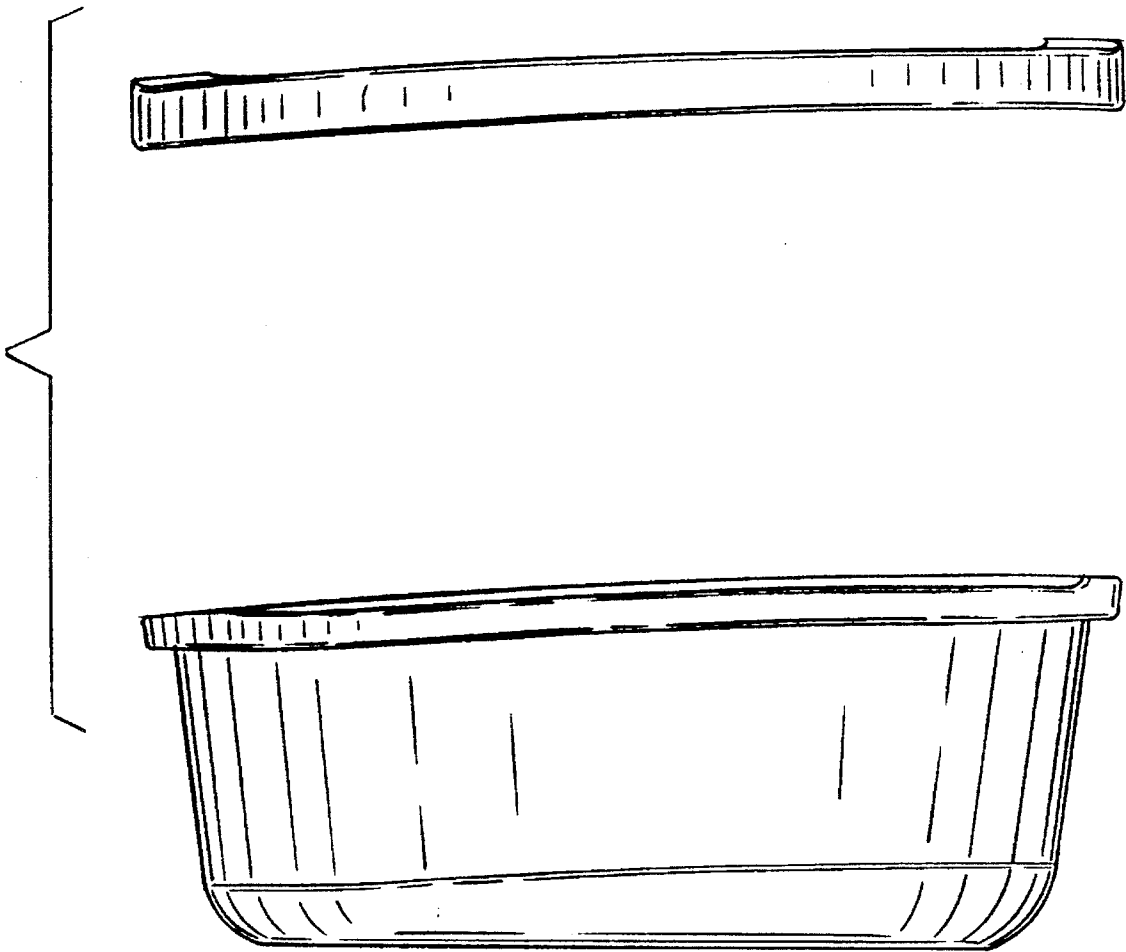

FIG. 9

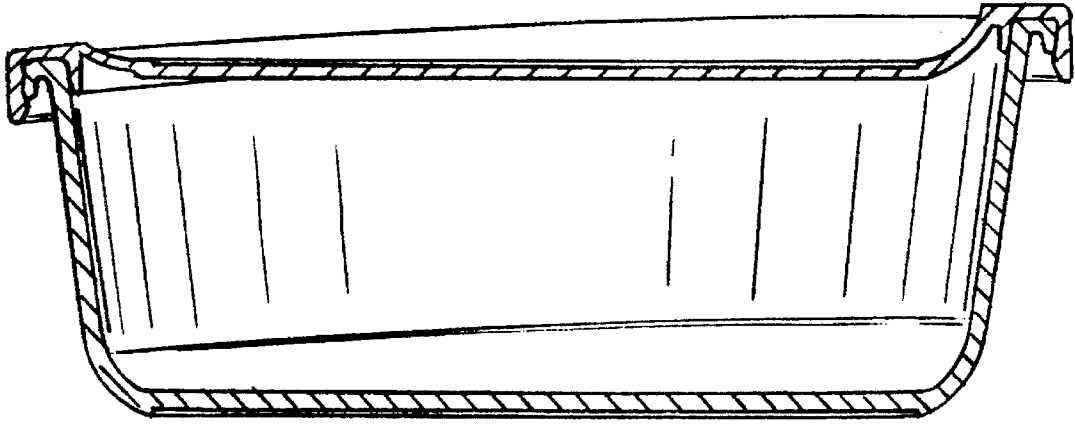

FIG. 10

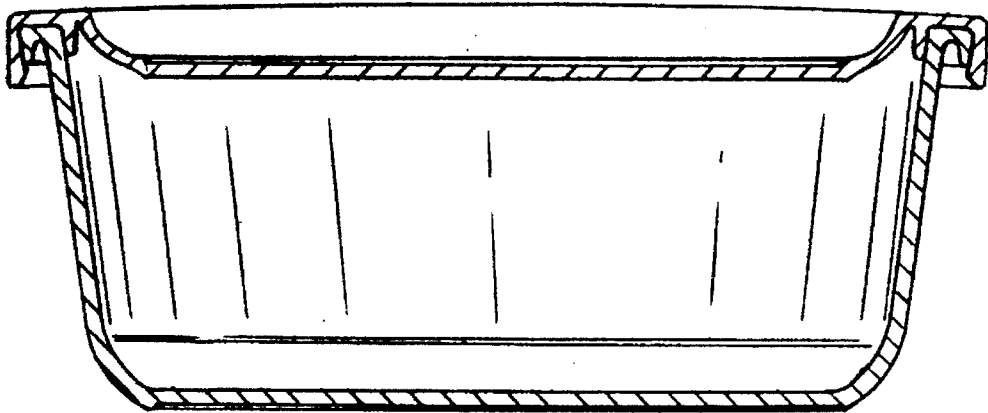

FIG. 11