



US00D682804S

(12) **United States Design Patent**
Cheung et al.

(10) **Patent No.:** **US D682,804 S**

(45) **Date of Patent:** **** May 21, 2013**

(54) **WIRELESS PHONE SET**

Primary Examiner — Sheryl Lane

(76) Inventors: **George Cheung**, Norwalk, CA (US);
Peter Lee, Norwalk, CA (US)

(74) *Attorney, Agent, or Firm* — Raymond Y. Chan; David and Raymond Patent Firm

(**) Term: **14 Years**

(57) **CLAIM**

The ornamental design for a wireless phone set, as shown and described.

(21) Appl. No.: **29/372,457**

(22) Filed: **Nov. 23, 2010**

DESCRIPTION

(51) **LOC (9) Cl.** **14-03**

(52) **U.S. Cl.**

USPC **D14/144**

(58) **Field of Classification Search** D14/144,
D14/142, 148, 140, 140.8, 141.1, 138 AA,
D14/496, 341, 345, 346, 138 AD, 138 AB,
D14/138 G, 138 R; 379/419, 440, 454, 455,
379/433.01, 433.04, 434, 435, 436; 455/550-575;
D13/108

See application file for complete search history.

FIG. 1 is a perspective view of wireless phone set showing my new design.

FIG. 2 is a front view thereof.

FIG. 3 is a rear view thereof, wherein the broken lines represent a slot on top of the phone and a phone inlet at the phone base that the broken lines are for illustrative purposes only and form no part of the claimed design.

FIG. 4 is a right view thereof, wherein the broken lines represent the phone inlet at the phone base that the broken lines are for illustrative purposes only and form no part of the claimed design.

FIG. 5 is a left view thereof, wherein the broken lines represent the phone inlet at the phone base that the broken lines are for illustrative purposes only and form no part of the claimed design; and,

FIG. 6 is a top perspective view thereof.

The broken line showing of the wireless phone set is included for the purpose of illustrating portions of the article and forms no part of the claimed design.

(56) **References Cited**

U.S. PATENT DOCUMENTS

D395,304	S	*	6/1998	Mori et al.	D14/144
D423,001	S	*	4/2000	Shindo	D14/149
D428,868	S	*	8/2000	Bryant et al.	D14/148
D432,108	S	*	10/2000	Isonaga	D14/151
D439,231	S	*	3/2001	Song	D14/144

* cited by examiner

1 Claim, 6 Drawing Sheets

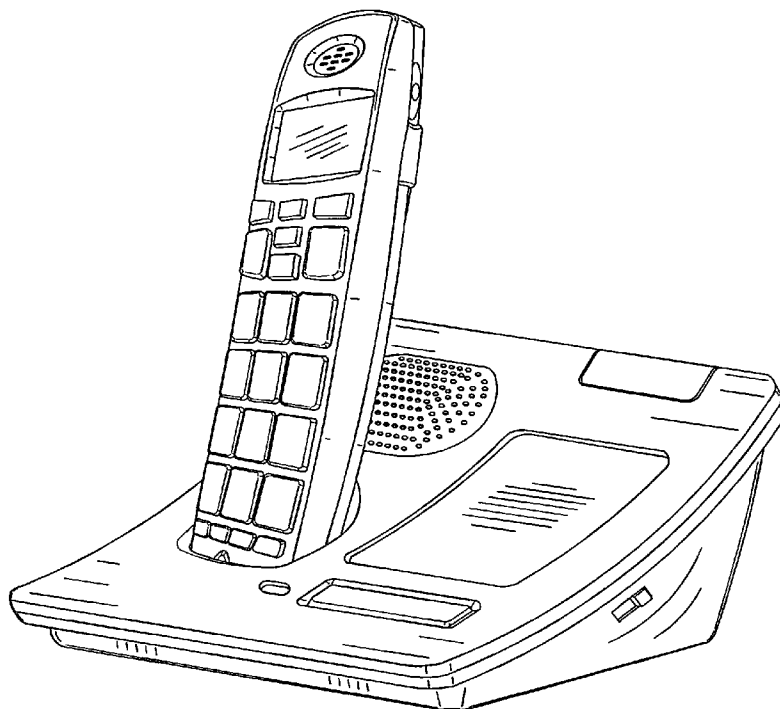

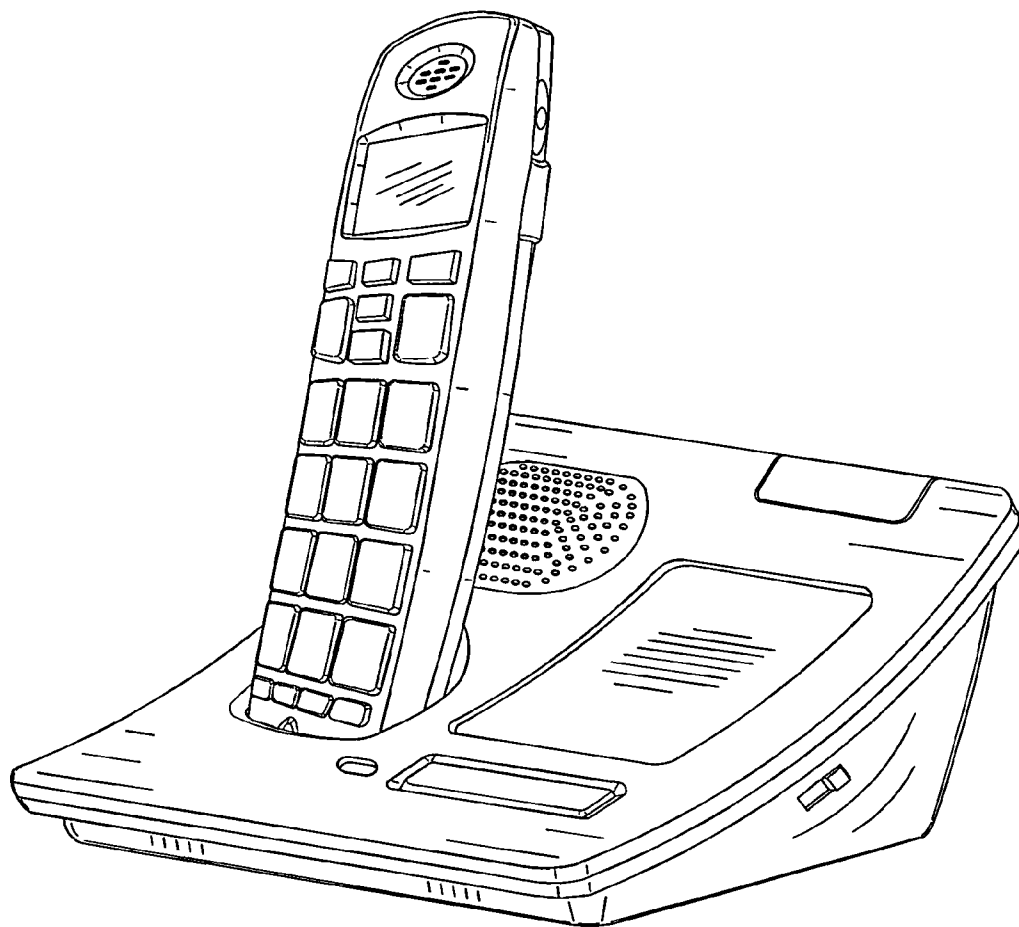

FIG. 1

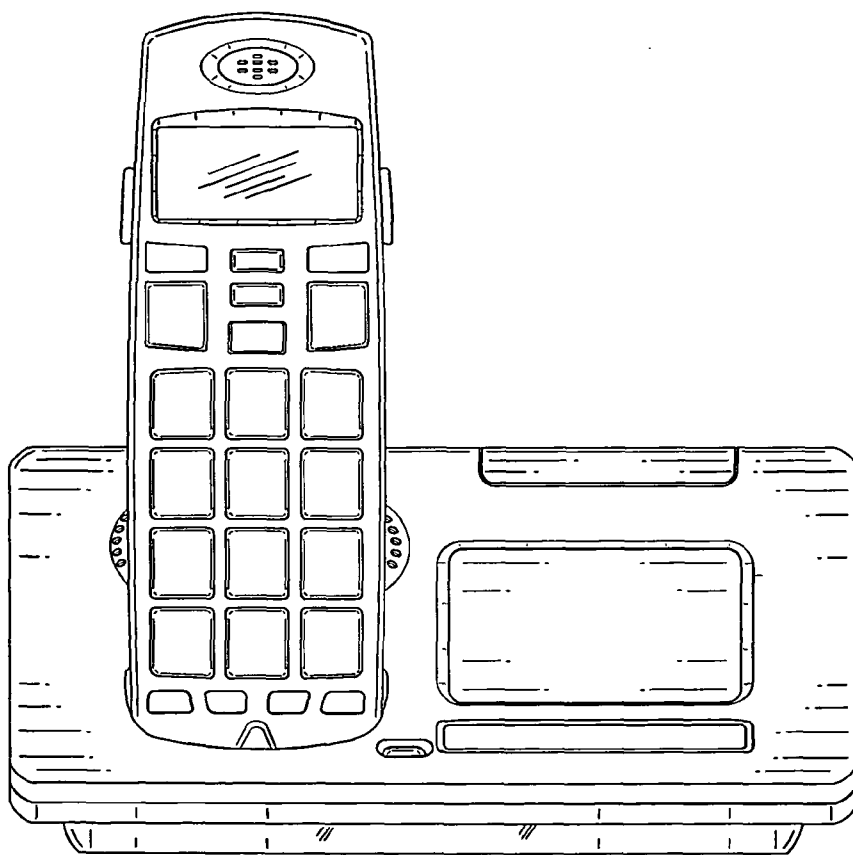

FIG.2

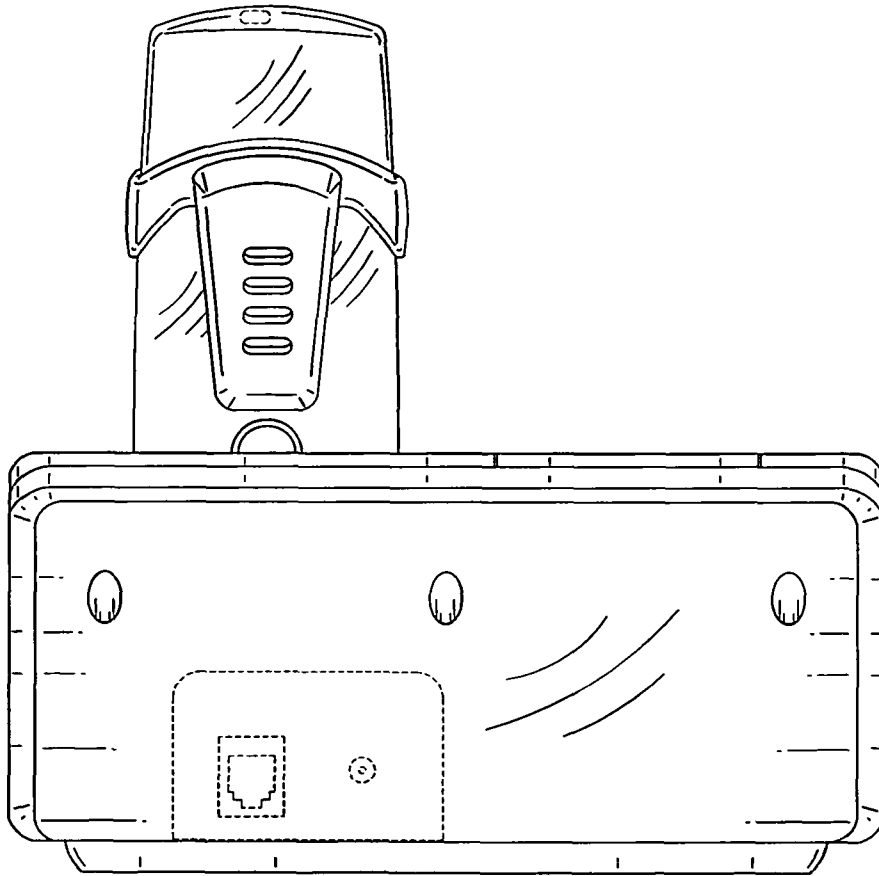

FIG.3

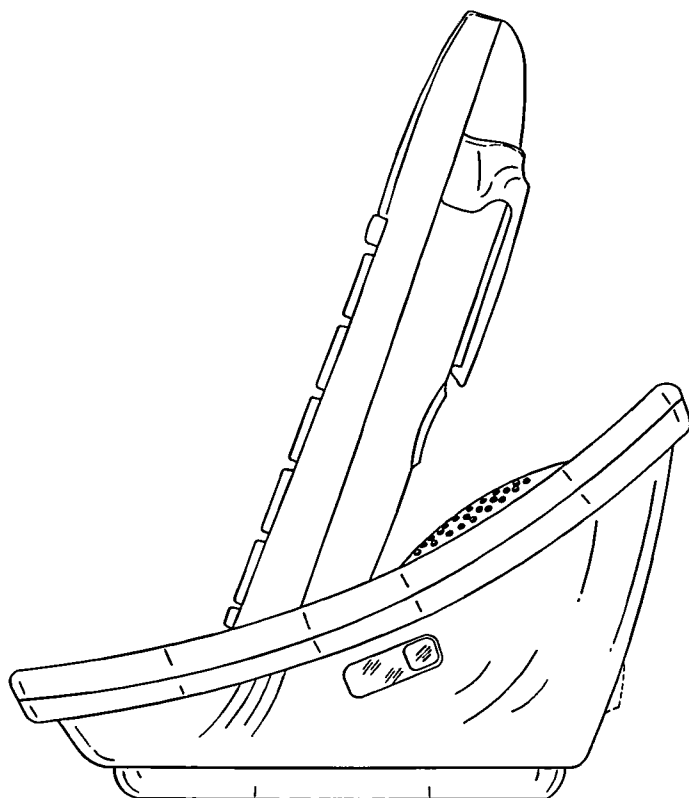

FIG.4

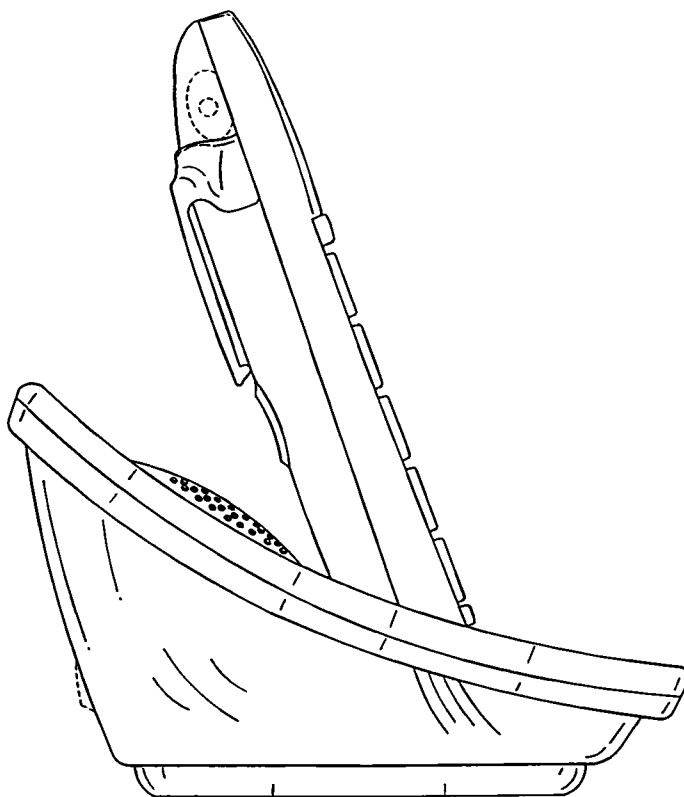

FIG.5

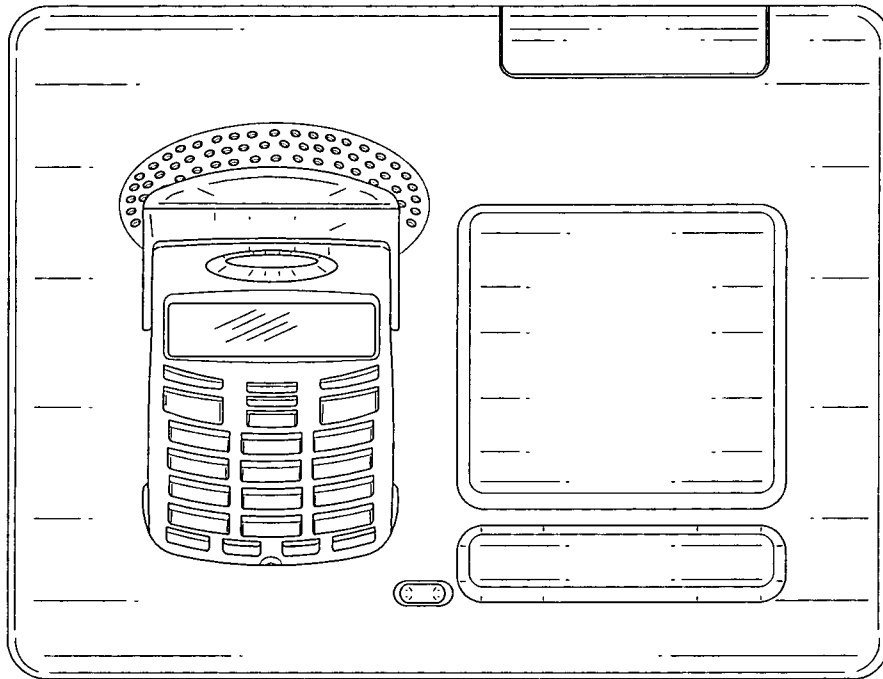

FIG.6