



US00D489975S

(12) **United States Design Patent** (10) **Patent No.:** **US D489,975 S**  
**Jackson et al.** (45) **Date of Patent:** **\*\* May 18, 2004**

(54) **FOOD PACKAGE**

(75) Inventors: **Daniel C. Jackson**, Plymouth, MN (US); **Nicolas Bouveret**, St-Placide (CA); **Jean-Pierre Lacroix**, Bois d'Amont (FR)

(73) Assignee: **Land O'Lakes, Inc.**, Arden Hills, MN (US)

(\*\*) Term: **14 Years**

(21) Appl. No.: **29/165,907**

(22) Filed: **Aug. 20, 2002**

(51) **LOC (7) Cl.** ..... **09-03**

(52) **U.S. Cl.** ..... **D9/425**

(58) **Field of Search** ..... D9/414, 424, 425, D9/426, 428, 429, 341; D7/619, 602, 641; 229/400, 406, 407, 938, 902, 903, 905, 906, 116.1, 108; 220/4.21, 4.27, 556, 669-675, 656-659; 426/106; 256/505, 515

(56) **References Cited**

**U.S. PATENT DOCUMENTS**

D257,107 S	9/1980	Daenen et al. ....	D7/1
D276,400 S	11/1984	Daenen et al. ....	D7/79
D276,401 S	11/1984	Daenen et al. ....	D7/79
D276,402 S	11/1984	Daenen et al. ....	D7/79
D285,906 S *	9/1986	Tyler .....	D9/425
4,819,824 A *	4/1989	Longbottom et al. ....	220/266
D312,968 S	12/1990	Wolff .....	D9/431
D330,312 S	10/1992	Narsutis .....	D7/629
D371,962 S	7/1996	Petruzzi .....	D9/423
D390,109 S *	2/1998	Tucker et al. ....	D9/425

(List continued on next page.)

**OTHER PUBLICATIONS**

Color Photographs of Packaging No. 1; views 1-1 through 1-8, four pages; publicly available prior to Aug. 20, 2001.  
Color Photographs of Packaging No. 2; views 2-1 through 2-8; four pages; publicly available prior to Aug. 20, 2001.

(List continued on next page.)

*Primary Examiner*—Prabhakar Deshmukh

(74) *Attorney, Agent, or Firm*—Westman, Champlin & Kelly, P.A.

(57) **CLAIM**

The ornamental design for a food package, as shown and described.

**DESCRIPTION**

FIG. 1 is a perspective view of an embodiment of the food package of the present invention;  
FIG. 2 is a top plan view of the embodiment;  
FIG. 3 is a front elevational view of the embodiment;  
FIG. 4 is a right side elevational view of the embodiment;  
FIG. 5 is a left elevational view of the embodiment;  
FIG. 6 is a rear side elevational view of the embodiment;  
FIG. 7 is a bottom plan view of the embodiment;  
FIG. 8 is a perspective view of a second embodiment of the food package of the present invention;  
FIG. 9 is a top plan view of the second embodiment;  
FIG. 10 is a front elevational view of the second embodiment;  
FIG. 11 is a right side elevational view of the second embodiment;  
FIG. 12 is a left elevational view of the second embodiment;  
FIG. 13 is a rear side elevational view of the second embodiment;  
FIG. 14 is a bottom plan view of the second embodiment;  
FIG. 15 is a perspective view of a third embodiment of the food package of the present invention;  
FIG. 16 is a top plan view of the third embodiment;  
FIG. 17 is a front elevational view of the third embodiment;  
FIG. 18 is a right side elevational view of the third embodiment;  
FIG. 19 is a left elevational view of the third embodiment;  
FIG. 20 is a rear side elevational view of the third embodiment; and,  
FIG. 21 is a bottom plan view of the third embodiment.

**1 Claim, 6 Drawing Sheets**

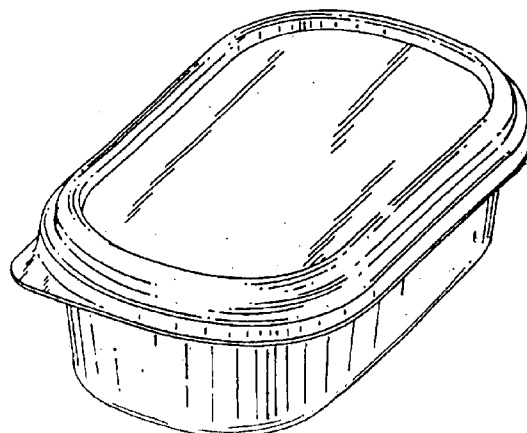

## U.S. PATENT DOCUMENTS

D392,884 S	3/1998	Hayes	.....	D9/431
D427,063 S	* 6/2000	May	.....	D9/425
D428,310 S	7/2000	Zettle et al.	.....	D7/629
6,170,696 B1	* 1/2001	Tucker et al.	.....	220/793
D437,685 S	2/2001	Liu	.....	D3/294
D440,470 S	4/2001	Tucker et al.	.....	D7/629
D440,830 S	4/2001	Tucker et al.	.....	D7/629
D442,484 S	5/2001	Maxwell et al.	.....	D9/347
D443,184 S	6/2001	Maxwell et al.	.....	D7/629
D443,484 S	6/2001	Maxwell et al.	.....	D7/629
D443,798 S	6/2001	Tucker et al.	.....	D7/629
D445,311 S	7/2001	Emonet et al.	.....	D7/629
D445,649 S	* 7/2001	Maxwell et al.	.....	D7/629
D445,650 S	7/2001	Maxwell et al.	.....	D7/629
D446,077 S	8/2001	Tucker et al.	.....	D7/392.1
D447,382 S	9/2001	Tucker et al.	.....	D7/392.1
D449,495 S	10/2001	Tucker et al.	.....	D7/629
D450,240 S	* 11/2001	Haag et al.	.....	D9/416
D450,983 S	11/2001	Tucker et al.	.....	D7/629
D451,769 S	12/2001	Stanos et al.	.....	D7/629
D456,713 S	5/2002	Bried et al.	.....	D9/449
D462,880 S	9/2002	Maxwell et al.	.....	D7/629
6,467,647 B1	10/2002	Tucker et al.	.....	220/793

## OTHER PUBLICATIONS

Color Photographs of Packaging No. 3; views 3–1 through 3–9; five pages; publicly available prior to Aug. 20, 2001.

Color Photographs of Packaging No. 4; views 4–1 through 4–5; three pages; publicly available prior to Aug. 20, 2001.

Color Photographs of Packaging No. 5; views 5–1 through 5–5; three pages; publicly available prior to Aug. 20, 2001.

Color Photographs of Packaging No. 6; views 6–1 through 6–9; five pages; publicly available prior to Aug. 20, 2001.

Color Photographs of Packaging No. 7; views 7–1 through 7–9; five pages; publicly available prior to Aug. 20, 2001.

Color Photographs of Packaging No. 8; views 8–1 through 8–9; five pages; publicly available prior to Aug. 20, 2001.

Color Photographs of Packaging No. 9; views 9–1 through 9–9; five pages; publicly available prior to Aug. 20, 2001.

Color Photographs of Packaging No. 10; views 10–1 through 10–5; three pages; publicly available prior to Aug. 20, 2001.

Color Photographs of Packaging No. 11; views 11–1 through 11–5; three pages; publicly available prior to Aug. 20, 2001.

Color Photographs of Packaging No. 12; views 12–1 through 12–9; five pages; publicly available prior to Aug. 20, 2001.

Color Photographs of Packaging No. 13; views 13–1 through 13–9; five pages; publicly available prior to Aug. 20, 2001.

Color Photographs of Packaging No. 14; views 14–1 through 14–5; three pages; publicly available prior to Aug. 20, 2001.

Color Photographs of Packaging No. 15; views 15–1 through 15–5; three pages; publicly available prior to Aug. 20, 2001.

Color Photographs of Packaging No. 16; views 16–1 through 16–9; five pages; publicly available prior to Aug. 20, 2001.

Color Photographs of Packaging No. 17; views 17–1 through 17–9; five pages; publicly available prior to Aug. 20, 2001.

Color Photographs of Packaging No. 18; views 18–1 through 18–5; three pages; publicly available prior to Aug. 20, 2001.

Color Photographs of Packaging No. 19; views 19–1 through 19–9; five pages; publicly available prior to Aug. 20, 2001.

Color Photographs of Packaging No. 20; views 20–1 through 20–5; three pages; publicly available prior to Aug. 20, 2001.

Color Photographs of Packaging No. 21; views 21–1 through 21–9; five pages; publicly available prior to Aug. 20, 2001.

Color Photographs of Packaging No. 22; views 22–1 through 22–9; five pages; publicly available prior to Aug. 20, 2001.

Color Photographs of Packaging No. 23; views 23–1 through 23–5; three pages; publicly available prior to Aug. 20, 2001.

Color Photographs of Packaging No. 24; views 24–1 through 24–9; five pages; publicly available prior to Aug. 20, 2001.

Color Photograph of Packaging No. 25; view 25–1; one page; publicly available prior to Aug. 20, 2001.

Color Photographs of Packaging No. 26; views 26–1 through 26–5; three pages; publicly available prior to Aug. 20, 2001.

Color Photographs of Packaging No. 27; views 27–1 through 27–9; five pages; publicly available prior to Aug. 20, 2001.

Color Photographs of Packaging No. 28; views 28–1 through 28–9; five pages publicly available prior to Aug. 20, 2001.

Color Photographs of Packaging No. 29; views 29–1 through 29–5; three pages; publicly available prior to Aug. 20, 2001.

\* cited by examiner

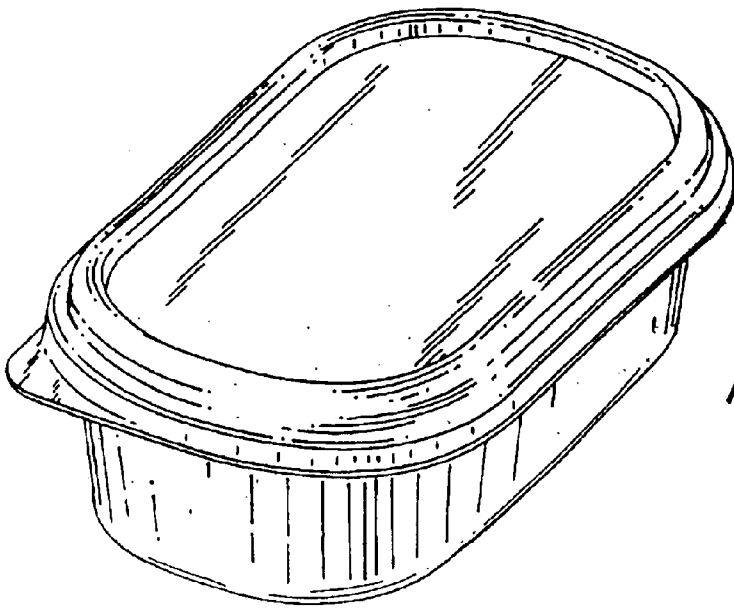

*Fig. 1*

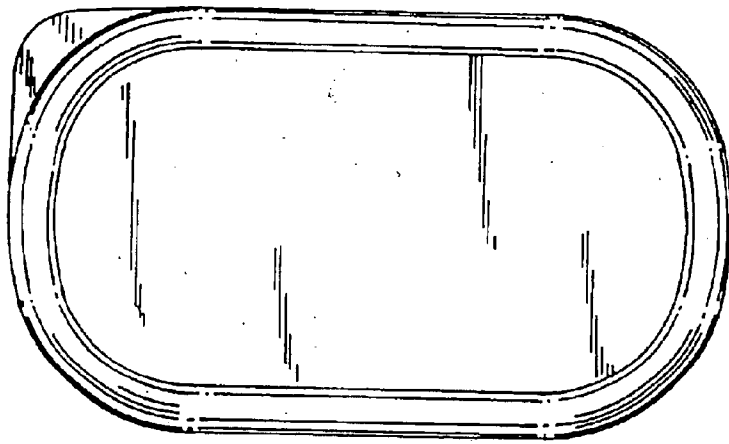

*Fig. 2*

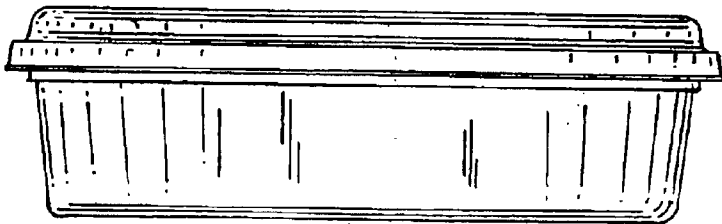

*Fig. 3*

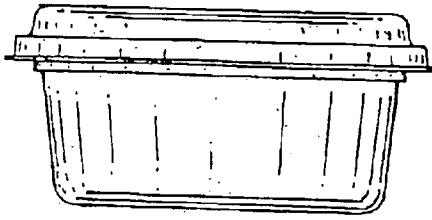

*Fig. 4*

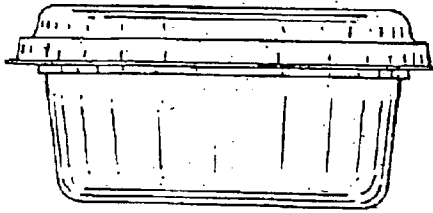

*Fig. 5*

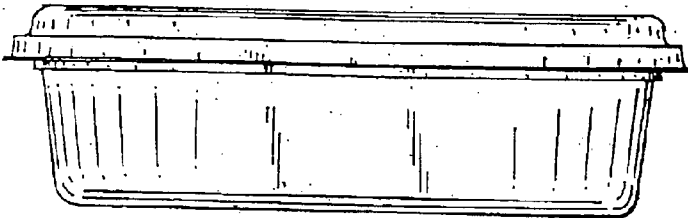

*Fig. 6*

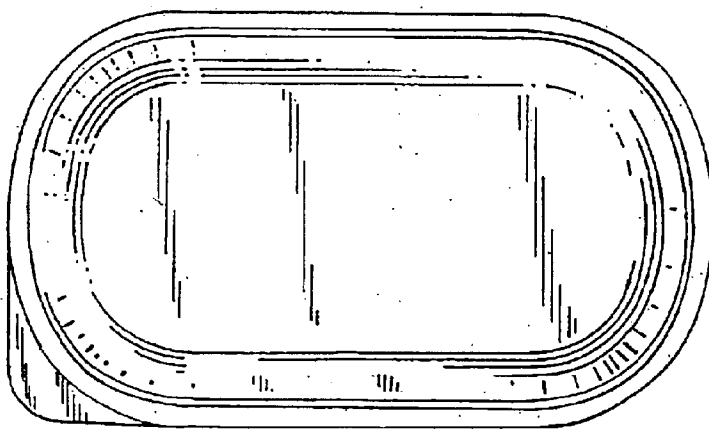

*Fig. 7*

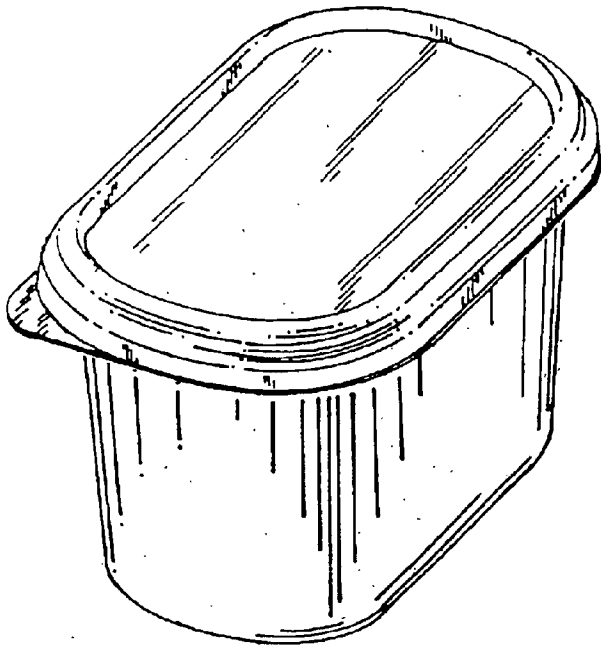

*Fig. 8*

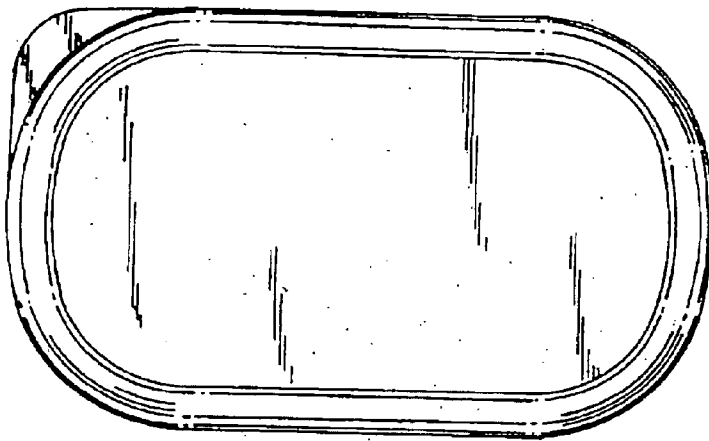

*Fig. 9*

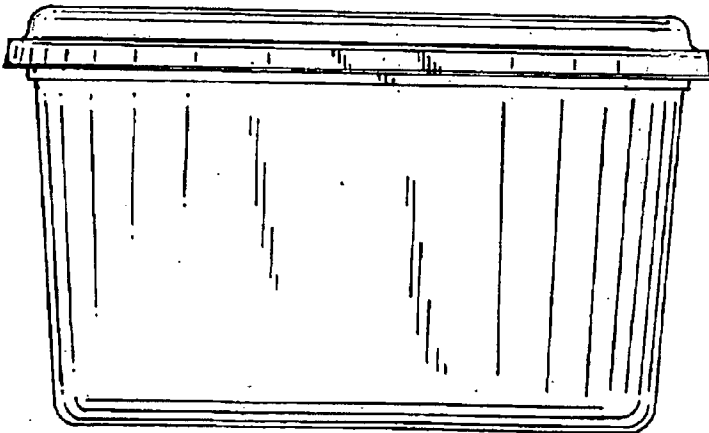

*Fig. 10*

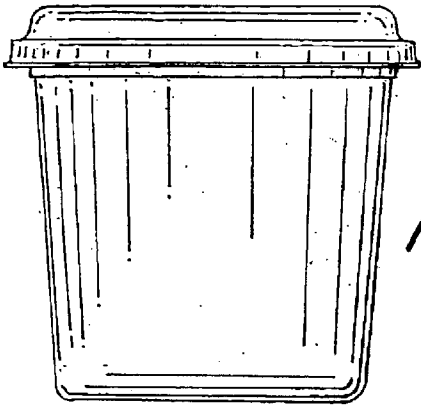

*Fig. 11*

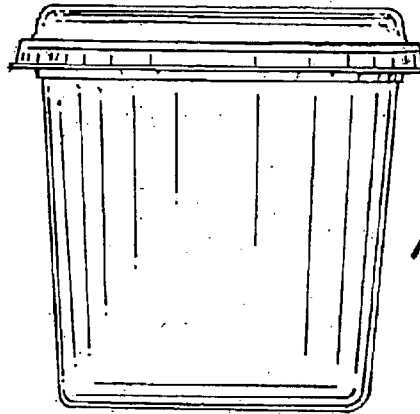

*Fig. 12*

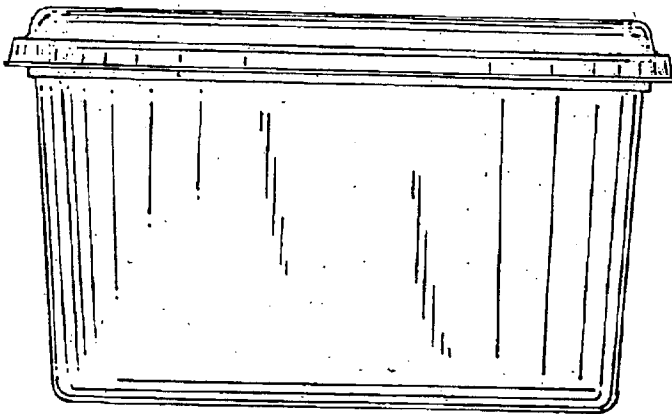

*Fig. 13*

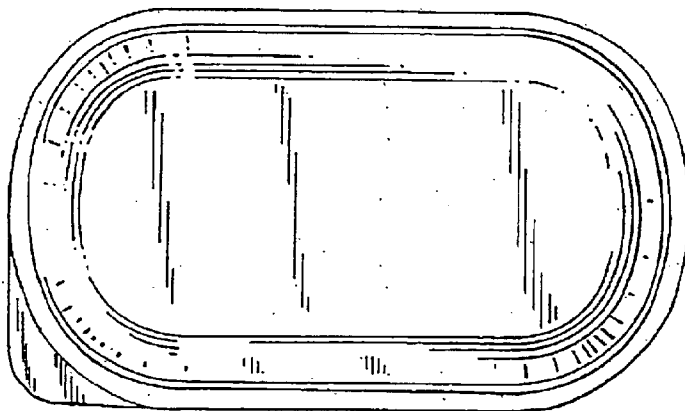

*Fig. 14*

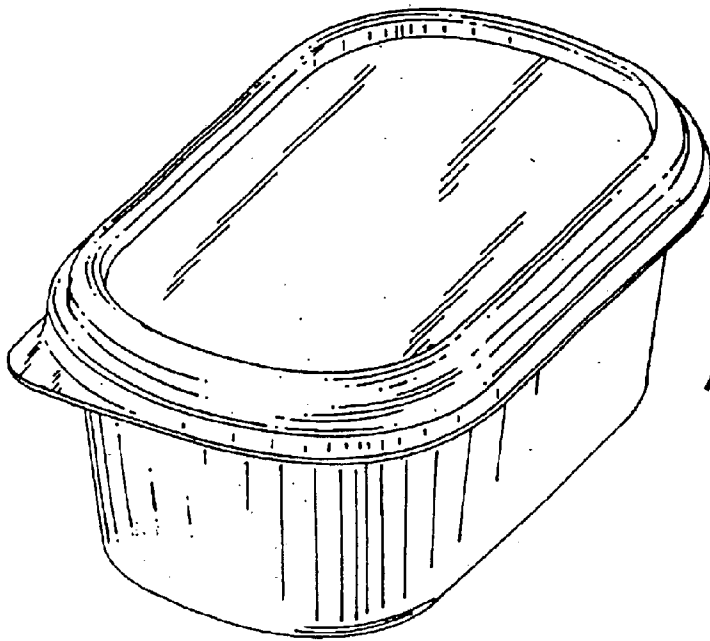

*Fig. 15*

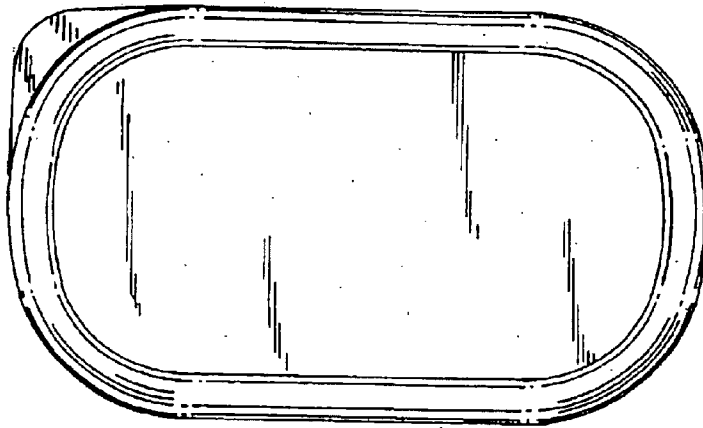

*Fig. 16*

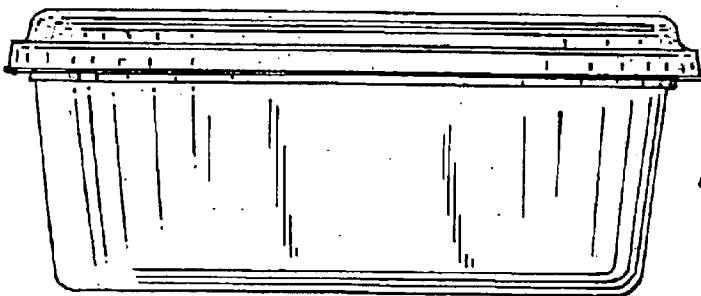

*Fig. 17*

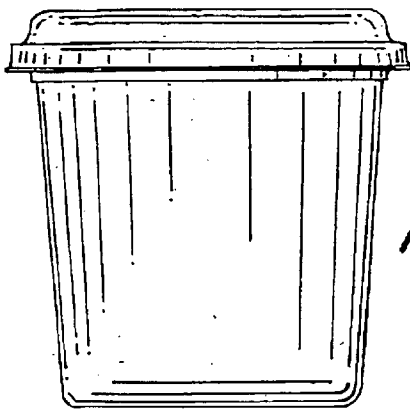

*Fig. 18*

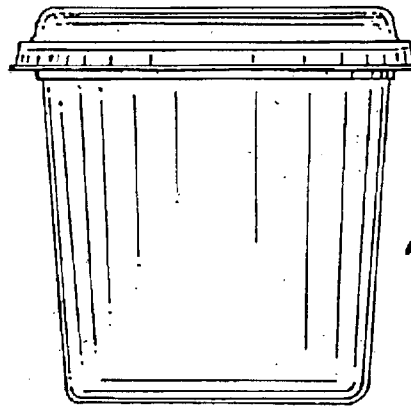

*Fig. 19*

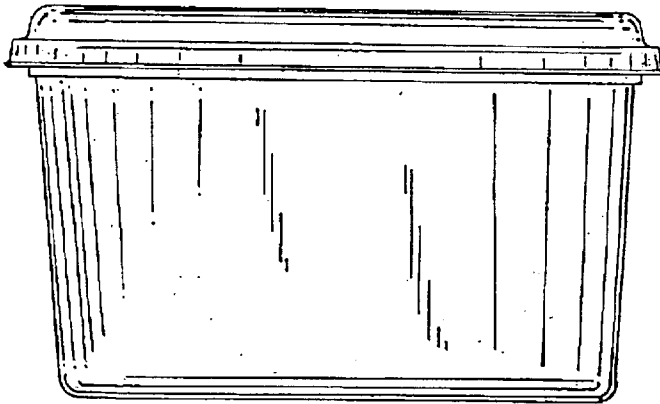

*Fig. 20*

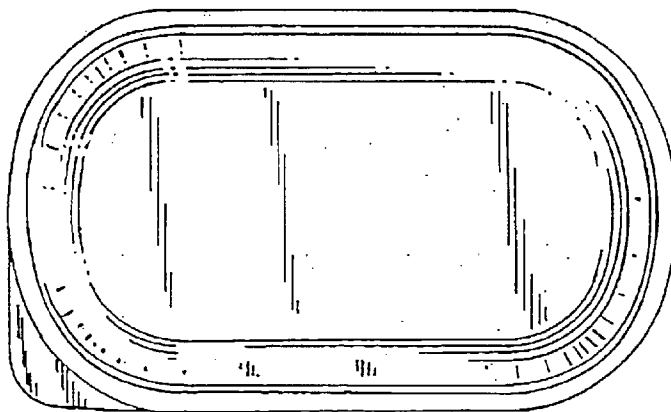

*Fig. 21*