



**Published:**

— *with international search report (Art. 21(3))*

— *with amended claims (Art. 19(1))*

## FORTIFIED PLASTIC CONNECTOR MOUNT FOR DISPOSABLE DEVICES

### CROSS REFERENCE TO RELATED APPLICATIONS

**[0001]** This application claims the full Paris Convention benefit of and priority to U.S. provisional application no. 61/755,640 filed January 23, 2013, the contents of which are incorporated by this reference as if fully set forth herein in their entirety.

### BACKGROUND

#### 1. Field

**[0002]** This disclosure relates to a plastic disposable mount fortified to withstand higher forces applied to a shaft.

#### 2. General Background

**[0003]** Torque drivers and torque limiting drivers are widely used throughout manufacturing, assembly and the medical industry. Torque-limiting drivers have a factory pre-set torque to ensure the accuracy and toughness required to meet a demanding surgical environment. Disposable torque drivers are often rated to withstand a maximum rotational force applied thereto before the mounting of a drive tool fails.

**[0004]** The medical industry has made use of both reusable and disposable torque-limiting drivers. In a surgical context, there is little room for error and these drivers must impart a precise amount of torque.

**[0005]** Reusable drivers require constant recalibration to ensure that the driver is imparting the precise amount of torque. Recalibration is a cumbersome task, but must be done routinely.

**[0006]** Disposable drivers are an easy to use and reliable alternative to the reusable drivers. Typically, a medical device such as an implant, for example, is packaged with a

disposable driver designed to the implant's specifications. Once the driver has been used, it can be discarded. Thus, a surgeon can have complete confidence that the disposable driver, packaged with an implant, will impart either the precise amount of torque required or at least the amount of torque required (for fixed devices). Typically, the torque requirement is different for different operations and for different implants. For example, applications may include those in the field of orthopedic surgery, construction and emplacement of implants, etc.

**[0007]** These disposable drivers have been used for low torque applications. The standard torque values in these applications typically range from 4 to 20 inch-ounces. It has, however, been a challenge to develop a reliable disposable driver capable of imparting higher torques for larger applications.

#### **DISCLOSURE**

**[0008]** Torque is a measure of how much force acting on an object causes that object to rotate. In the case of a driver and a fastener, this measurement can be calculated mathematically in terms of the cross product of specific vectors:

$$\tau = r \times F$$

**[0009]** Where  $r$  is the vector representing the distance and direction from an axis of a fastener to a point where the force is applied and  $F$  is the force vector acting on the driver.

**[0010]** Torque has dimensions of force times distance and the SI unit of torque is the Newton meter (N m). The joule, which is the SI unit for energy or work, is also defined as an Nm, but this unit is not used for torque. Since energy can be thought of as the result of force times distance, energy is always a scalar whereas torque is force cross-distance and so is a vector-valued quantity. Other non-SI units of torque include pound-force-feet, foot-pounds-force, ounce-force-inches, meter-kilograms-force, inch-ounces or inch pounds.

**[0011]** A fortified plastic connector mount, in accordance with the present disclosure, has a handle, a body and a work-piece engaging tip. Within the cylindrical body there is a torque-limiting assembly. The torque-limiting assembly includes an upper cylindrical shank and a lower cylindrical shank. The upper cylindrical shank and the lower

cylindrical shank have a plurality of teeth. The teeth have a vertical face, an inclined face and a substantially flat peak. The inclined face is defined by a first radius of curvature that transitions to the substantially flat peak. The teeth are spaced circumferentially and spiral around the upper cylindrical shank and a lower cylindrical shank. There is a spring for applying pressure across the upper cylindrical shank and the lower cylindrical shank. The teeth of the upper cylindrical shank and the lower cylindrical shank engage for relative rotation when the handle is turned and disengage when a predetermined value of torque is exceeded.

**[0012]** A fortified plastic connector mount, in accordance with the present disclosure of a device with a plastic nose having a distal and a proximal end, formed as part of or affixed to the flat top of a body; the nose having a polygonal channel guide with corners. The channel formed axial and centered in the nose and of a size to accept a tool or shaft; at least one pair of force buttressing ribs "FBR" wherein said FBR have a bottom affixed at the flat top and the FBR has a support edge affixed to an annular outer wall of the nose; and, wherein the proximal end of the nose is affixed at the flat top. In some instances the channel is square.

**[0013]** A fortified plastic connector mount, in accordance with the present disclosure of a device with a plastic nose having a distal and a proximal end, formed as part of or affixed to the flat top of a body; the nose having a square channel guide with corners. The channel formed axial and centered in the nose and of a size to accept a tool or shaft; four pairs of force buttressing ribs "FBR" wherein said FBR have a bottom affixed at the flat top and the FBR has a support edge affixed to an annular outer wall of the nose; and, wherein the proximal end of the nose is affixed at the flat top. The four pairs of FBR each pair being positioned along one of the four side of the square channel. In some instances, each FBR further comprises an interior edge and an outer edge and each outer edge is aligned with a corner.

**[0014]** A fortified plastic connector mount, in accordance with the present disclosure of a device with an elongated nose with a distal end fluidly connected to an interior channel formed axially therein; a wall with a predetermined thickness surrounding the interior channel with an outer annular surface; a flat top affixed to or formed as part of

the proximal end of the nose; and, at least one pair of force buttressing ribs "FBR" (120 & 120') affixed to both the flat top and the annular wall.

**[0015]** A fortified plastic connector mount, in accordance with the present disclosure of a device with an elongated nose with a distal end fluidly connected to a square interior channel, with four corners, formed axially therein; a wall with a predetermined thickness surrounding the interior channel with an outer annular surface; a flat top affixed to or formed as part of the proximal end of the nose; four pairs of force buttressing ribs "FBR" affixed to both the flat top and the annular wall; and, the four pairs of FBR each aligned with one of the four walls of the interior channel.

**[0016]** The above-mentioned features of the present disclosure will become more apparent with reference to the following description taken in conjunction with the accompanying drawings wherein like reference numerals denote like elements and in which:

#### **Drawings**

**[0017]** FIG. 1 is a perspective view of a traditional connector mount.

**[0018]** FIG. 2 is a perspective view of a fortified connector mount in accordance with the present disclosure.

**[0019]** FIG. 3 is a side view of a fortified connector mount in accordance with the present disclosure.

**[0020]** FIG. 4 is a cut away along line "A-A" top perspective view of a fortified connector mount in accordance with the present disclosure.

**[0021]** Figure 5 is a diagrammatic view a fortified connector mount, less susceptible to failure than a traditional mount.

**[0022]** Figure 6 is a diagrammatic view of how a traditional non-fortified connector mount will fail under the same force the fortified mount of Figure 5 will tolerate.

**[0023]** FIGS. 7 and 8 are charts showing test to failure for a traditional mount shown in Figure 1.

**[0024]** FIGS. 9 and 10 are charts showing test to failure of the fortified mount of Figures 2-4.

**FURTHER DISCLOSURE**

**[0025]** Referring to Figures 1, 6, 7 and 8, there is a plastic molded connection mount 5, representative of traditional strength molded mounts for fixing or connecting tools and/or other connectors thereto. The connection mount has a nose 7, a neck 8, and are affixed to body 9. Such mounts are used to provide support for a shaft (not shown) and hold fast a shaft against a force applied via rotation of the nose 7 and body 9. A plurality of support flanges 11 are positioned around a neck 8 to add strength while saving material. A connection mount has at its distal end 13 a guide 15 whereby a tool or shaft (not shown) may be mounted. An annular wall 17 surrounds the connection mount. Figures 7 and 8 are findings from two tests to failures of the performance of the traditional molded mount illustrated in Figure 1.

**[0026]** Referring to FIGS. 2-5, 9 and 10 there is a plastic molded fortified connector mount "CM" 50. The connector mount is a guide and/or anchor to mount, fix or connect tools and/or other connectors to the CM. The CM mount has a generally conical back nose 100, affixed to a body 102. The affixation of nose to body includes molding as a single piece. The body 102 is generally cylindrical and has a flat top 105. The nose back 100 has an annular outer wall 108.

**[0027]** The CM 50 is a support or encasement of a shaft which will hold fast a shaft against a force applied via rotation of the nose 100 and body 102. Even numbered sets of force buttressing ribs (FBR) 120 & 120' are positioned around the outer annular wall 108 of back nose 100. At the distal end 125 of the CM is a channel 150 which acts as a guide whereby a tool or shaft may be mounted. In some instances, the channel is generally square with four sides.

**[0028]** Figure 5 is a diagrammatic view of the nose in a fortified mount device. When shaft 400 within the drive channel 150, the corners of the shaft 410 are adjacent to the corner channels 155. The drive channel 150 is substantially square. Each channel corner 155 has been shown to be a region where the plastic tends to deform, break or otherwise fail under the rotational forces applied thereto via a rotating shaft 400. The corners 410 of the shaft when rotated against the channel corners 155 have significant impact on the corners and the plastic back nose 100. When shaft 400 within said drive

channel 150 is rotated at force one (F1) and force one (F1) is selected to be at the maximum tolerance of the fortified connector mount an un-fortified drive channel 150 will break deform and fail in less time and under/or under less force than a fortified connector mount 50. Ribs 200, support the connection mount, and prevent the wall structure, especially at the corners 410 of the nose from at least one of deforming, distorting and breaking due to failure under F1.

**[0029]** In the unfortified nose illustrated in figure 6 failure will occur as follows: The shaft "S" within a mount channel "MC" is rotated at a force which is within the operational tolerance of the disclosed fortified connector mount of figures 2-5 the similar sized non-fortified mount will distort, deform and/or break the wall "W" of the nose "N". Or stated in another way, in the absence of the strategically placed FBRs when force one (F1) is applied the mount channel will fail. The corners "C" of the shaft "S" when rotated against the corner of the mounting channel "CMC" have the most significant impact of force upon the back nose. It is at those CMC locations of the MC where there is the greatest possibility of a fortified wall will crack. The crack can occur because the opposite side of the wall at the corners does not have any bracing. Moreover, a thicker wall "W" would not make the wall any stronger or less likely to crack, but may, in fact, make it weaker. When enough force is applied to the opening of the nose cone, the walls of the nose "N" can deflect. If the nose wall deflects enough, a crack can occur and testing has shown that a thicker wall may crack under less force.

**[0030]** In the disclosed fortified mounting the back nose 100 is fortified or buttressed against shearing and other forces via very specifically placed ribs 120 & 120'. The wall structure 350 of the back nose between the annular outer wall 108 and the channel 150 is separated into alternating zones. Each zone is separated by a fortification. Zone 1 is the corner zone 300, zone 2 is the boundary wall zone 310 and the fortifications 325 are areas of the plastic molded back nose 100 which are located substantially directly between each channel corner 155, the annular wall 108 and the outer edge 200 of each rib Boundary wall zone 310 is substantially the same thickness 315 from drive channel 150 to the annular wall 108. That thickness will vary as one moves from the distal end 125 of the nose toward the flat top 105. However, the thickness of boundary wall 310 is

substantially the same cross section between fortifications 325. The back nose 100 has a proximal end 128 which is affixed to, formed as part of or mounted to the flat top 105 of the body. In some instances the distal end of the nose 125 is generally squareish with rounded or radiused corners 330 in cross section, and the proximal end is generally circular in cross section. In other instances both the distal end of the nose 125 and the proximal end 128 may be generally squareish with rounded or radiused corners in cross section. In the wall structure 350 the force buttressing ribs (FBR) 120 & 120' are pairs have a bottom edge 201 which is affixed to, or formed as part of or mounted to the flat top 105 of the body and also have interior edges 202 and outer edges 200. The FBR is attached, affixed, or formed as part of the back nose 100 on the annular wall 108 of the nose at the FBR support edge 210.

**[0031]** FBRs are positioned to be aligned with an edge or side of the drive channel 150 opening, as well as each corner 155. The FBR brace each corner whether the unit is being rotated clockwise or counter-clockwise, so the FBR is preferably inline with each side of each corner. These FBRs are at 90-degrees apart due to being at 180-degrees to the side of each opening they support. Being at 90-degrees and 180-degrees ensures that each side wall zone 310 and each corner zone 300 is equally braced.

**[0032]** FBRs may be positioned at angles other than 90-degrees or 180-degrees, however, there will be an unbalanced situation where one side could be weaker than the other side, and therefore not reinforcing the adjacent zone adequately to withstand the highest force requirement. Such other angles may be acceptable in lower force situation and are within the scope of this disclosure for such situations. . A plastic nose material will eventually crack if force beyond the limits of the use intended is applied. By placing each FRB at a 90-degree angle from its base, the 90-degree angle achieves a balance force load, so that each side of rib receives equal force and therefore eliminates the unbalance.

**[0033]** Figures 7 and 8 are measurements of a non-fortified connector mount tested to failure. Failure occurs at a load between 115 and 85 lbf and between 7 and 8 seconds.

Figures 9 and 10 are measurements of a fortified connector mount tested to failure. Failure occurs at a load between 140 and 150 lbf and between 17 and 18 seconds.

**[0034]** While the method and apparatus have been described in terms of what are presently considered to be the most practical and preferred implementations, it is to be understood that the disclosure need not be limited to the disclosed implementations. It is intended to cover various modifications and similar arrangements included within the spirit and scope of the claims, the scope of which should be accorded the broadest interpretation so as to encompass all such modifications and similar structures. The present disclosure includes any and all implementations of the following claims.

**[0035]** It should also be understood that a variety of changes may be made without departing from the essence of the disclosure. Such changes are also implicitly included in the description. They still fall within the scope of this disclosure. It should be understood that this disclosure is intended to yield a patent covering numerous aspects of the disclosure both independently and as an overall system and in both method and apparatus modes.

**[0036]** Further, each of the various elements of the disclosure and claims may also be achieved in a variety of manners. This disclosure should be understood to encompass each such variation, be it a variation of an implementation of any apparatus implementation, a method or process implementation, or even merely a variation of any element of these.

**[0037]** Particularly, it should be understood that as the disclosure relates to elements of the disclosure, the words for each element may be expressed by equivalent apparatus terms or method terms -- even if only the function or result is the same.

**[0038]** Such equivalent, broader, or even more generic terms should be considered to be encompassed in the description of each element or action. Such terms can be substituted where desired to make explicit the implicitly broad coverage to which this disclosure is entitled.

**[0039]** It should be understood that all actions may be expressed as a means for taking that action or as an element which causes that action.

**[0040]** Similarly, each physical element disclosed should be understood to encompass a disclosure of the action which that physical element facilitates.

**[0041]** Any patents, publications, or other references mentioned in this application for patent are hereby incorporated by reference. In addition, as to each term used it should be understood that unless its utilization in this application is inconsistent with such interpretation, common dictionary definitions should be understood as incorporated for each term and all definitions, alternative terms, and synonyms such as contained in at least one of a standard technical dictionary recognized by artisans and the Random House Webster's Unabridged Dictionary, latest edition are hereby incorporated by reference.

**[0042]** Finally, all referenced listed in the Information Disclosure Statement or other information statement filed with the application are hereby appended and hereby incorporated by reference; however, as to each of the above, to the extent that such information or statements incorporated by reference might be considered inconsistent with the patenting of this/these disclosure(s), such statements are expressly not to be considered as made by the applicant(s).

**[0043]** In this regard it should be understood that for practical reasons and so as to avoid adding potentially hundreds of claims, the applicant has presented claims with initial dependencies only.

**[0044]** Support should be understood to exist to the degree required under new matter laws -- including but not limited to United States Patent Law 35 USC 132 or other such laws -- to permit the addition of any of the various dependencies or other elements presented under one independent claim or concept as dependencies or elements under any other independent claim or concept.

**[0045]** To the extent that insubstantial substitutes are made, to the extent that the applicant did not in fact draft any claim so as to literally encompass any particular implementation, and to the extent otherwise applicable, the applicant should not be understood to have in any way intended to or actually relinquished such coverage as the applicant simply may not have been able to anticipate all eventualities; one skilled in

the art, should not be reasonably expected to have drafted a claim that would have literally encompassed such alternative implementations.

**[0046]** Further, the use of the transitional phrase “comprising” is used to maintain the “open-end” claims herein, according to traditional claim interpretation. Thus, unless the context requires otherwise, it should be understood that the term “comprise” or variations such as “comprises” or “comprising”, are intended to imply the inclusion of a stated element or step or group of elements or steps but not the exclusion of any other element or step or group of elements or steps.

**[0047]** Such terms should be interpreted in their most expansive forms so as to afford the applicant the broadest coverage legally permissible.

**Claims**

1. A plastic connector mount (50) comprising:
  - a nose (100) with a proximal end (128) formed as part of or affixed to the flat top (105) of a body (102);
  - at least one pair of force buttressing ribs "FBR" (120 & 120');
  - a distal end (125) of a back nose (100);
  - a polygonal channel (150) guide having corners (155) the channel formed axial and centered in the nose of a size to accept a tool or shaft; and,
  - wherein said FBR have a bottom (201) affixed at the flat top and the FBR has a support edge (210) affixed to the nose.
2. The connector mount of claim 1 wherein the polygonal channel is square having corners (155).
3. The connector mount of claim 2 wherein there are four pairs of FBR each pair being positioned along one of the four side of the square channel.
4. The connector mount of claim 2 wherein each FBR further comprises an interior edge (202) and an outer edge (200) and each outer edge is aligned with a corner (155).
5. A fortified plastic connector mount (50) comprising:
  - an elongated back nose (100) with a distal end (125) fluidly connected to an interior channel (150) formed axially therein;
  - a wall (350) with a predetermined thickness surrounding the interior channel with an outer annular surface (108);
  - a flat top (105) affixed to or formed as part of the proximal end (128) of the nose; and,

at least one pair of force buttressing ribs "FBR" (120 & 120') affixed to both the flat top and the annular wall.

6. The fortified plastic connector mount of claim 5 wherein:  
the wall interior channel is square and has four corners (155);  
there are four pairs of FBR each aligned with one of the four walls of the interior channel; and,  
each FRB having an outer edge (200).
7. The fortified plastic connector mount of claim 6 wherein:  
the wall is separated into alternating zones(300 & 310); and,  
each zone is separated by a fortification(325).
8. The fortified plastic connector mount of claim 7 wherein:  
the fortifications are areas of the plastic molded back nose which are located substantially directly between each channel corner; and,  
the outer edge of each FRB is substantially the same thickness (315) from channel to the annular wall.
9. A method of fortifying a connector mount, the method comprising:  
forming an annular wall (108) around a square channel (150) connector mount;  
supporting load on the connector mount with at least two pairs of force buttressing ribs "FBR" (120 & 120') whereby load from the shaft (400) exerted on the annular wall is transferred to the flat top (105) of the connector mount; and,  
whereby the connection mount holds the shaft without failure at a load between a force (F1) of 85 and 115 lbf for a predetermined time.
10. The method of claim 9, wherein the connector mount has four pairs of FBRs, wherein one pair is on each side.

11. The method of claim 10, wherein each FBR is aligned with a corner (155) of the connector mount.
12. The method of claim 11, wherein the predetermined time is at least 8 seconds.
13. The method of claim 11, wherein the predetermined time is at least 9 seconds.
14. The method of claim 11, wherein the predetermined time is at least 10 seconds.
15. The method of claim 11, whereby the connection mount holds the shaft without failure at a load between a force (F1) of 140 and 150 pound-feet for at least 10 seconds.
16. The method of claim 11, whereby the connection mount holds the shaft without failure at a load between 140 and 150 pound-feet for at least 12 seconds.
17. The method of claim 11, whereby the connection mount holds the shaft without failure at a load between 140 and 150 pound-feet for at least 15 seconds.
18. The method of claim 11, whereby the connection mount holds the shaft without failure at a load between 140 and 150 pound-feet for at least 16 seconds.
19. The method of claim 11, whereby the connection mount holds the shaft without failure at a load between 140 and 150 pound-feet for at least 17 seconds.
20. The method of any one of claims 13-18, wherein a non-fortified mount will at least one of distort, deform, and break the wall ("W") of the nose ("N") during the predetermined time in the absence of the strategically placed FBRs when the force (F1) is applied.

AMENDED CLAIMS  
received by the International Bureau on  
01 JULY 2014  
(01.07.2014)

### Claims

1. A plastic connector mount (50) comprising:
  - a nose (100) with a proximal end (128) formed as part of or affixed to the flat top (105) of a body (102);
  - at least four pairs of force buttressing ribs "FBR" (120 & 120');
  - a distal end (125) of a back nose (100);
  - a square channel (150) guide having corners (155) the channel formed axial and centered in the nose of a size to accept a tool or shaft; and,
  - wherein said FBR have a bottom (201) affixed at the flat top and the FBR has a support edge (210) affixed along the length of the nose.
2. The connector mount of claim 1 wherein there are four pairs of FBR each pair being positioned along one of the four side of the square channel.
3. The connector mount of claim 1 wherein:
  - each FBR further comprises an interior edge (202) and an outer edge (200) and each outer edge is aligned with a corner (155);
  - each member of the FBR pair is aligned with a corner; and,
  - the outer edges of two adjacent pairs of FBRs align with the same corner with each oriented 90 degree apart.
4. A fortified plastic connector mount (50) comprising:
  - an elongated back nose (100) with a distal end (125) fluidly connected to a square interior channel (150) formed axially therein;
  - a wall (350) with a predetermined thickness surrounding the interior channel with an outer annular surface (108);
  - a flat top (105) affixed to or formed as part of the proximal end (128) of the nose;
  - four pairs of force buttressing ribs "FBR" (120 & 120') affixed to both the flat top and along the length of the annular wall;
  - each FBR has an interior edge and an outer edge;

each pair of FBRs have substantially parallel interior edges; and,  
whereby at each corner there are two FBRs, one member from each of two pairs, affixed at the corner offset by 90 degrees.

5. The fortified plastic connector mount of claim 4 wherein:  
the wall is separated into alternating zones(300 & 310); and,  
each zone is separated by a fortification(325).
6. The fortified plastic connector mount of claim 5 wherein:  
the fortifications are areas of the plastic molded back nose which are located substantially directly between each channel corner; and,  
each wall zone (310) is flat and substantially the same thickness (315) from channel to the annular wall; and,  
each corner zone (300) is curved and substantially the same thickness (315) from channel to the annular wall.
7. A method of fortifying a connector mount, the method comprising:  
forming an annular wall (108) around a square channel (150) connector mount;  
the annular wall being generally squareish with radiused corners;  
supporting load on the connector mount with four pairs of force buttressing ribs "FBR" (120 & 120') whereby pairs of FBRs are positioned along each flat portion of the annular wall (310) and load from the shaft (400) exerted on the annular wall is transferred to the flat top (105) of the connector mount; and,  
whereby the connection mount holds the shaft without failure at a load between a force (F1) of 85 and 115 lbf for a predetermined time.
8. The method of claim 7, wherein:  
of the four pairs of FBRs, one pair is on each side of the square channel; and, one rib of each pair is placed at each corner whereby there are two ribs at each corner separated by a 90 degree offset.
9. The method of claim 8, wherein each FBR is aligned with a corner (155) of the

connector mount.

10. The method of claim 9, wherein the predetermined time is at least 8 seconds.
11. The method of claim 9, wherein the predetermined time is at least 9 seconds.
12. The method of claim 9, wherein the predetermined time is at least 10 seconds.
13. The method of claim 9, whereby the connection mount holds the shaft without failure at a load between a force (F1) of 140 and 150 pound-feet for at least 10 seconds.
14. The method of claim 9, whereby the connection mount holds the shaft without failure at a load between 140 and 150 pound-feet for at least 12 seconds.
15. The method of claim 9, whereby the connection mount holds the shaft without failure at a load between 140 and 150 pound-feet for at least 15 seconds.
16. The method of claim 9, whereby the connection mount holds the shaft without failure at a load between 140 and 150 pound-feet for at least 16 seconds.
17. The method of claim 9, whereby the connection mount holds the shaft without failure at a load between 140 and 150 pound-feet for at least 17 seconds.
18. The method of any one of claims 10-17, wherein a non-fortified mount will at least one of distort, deform, and break the wall ("W") of the nose ("N") during the predetermined time in the absence of the strategically placed FBRs when the force (F1) is applied.

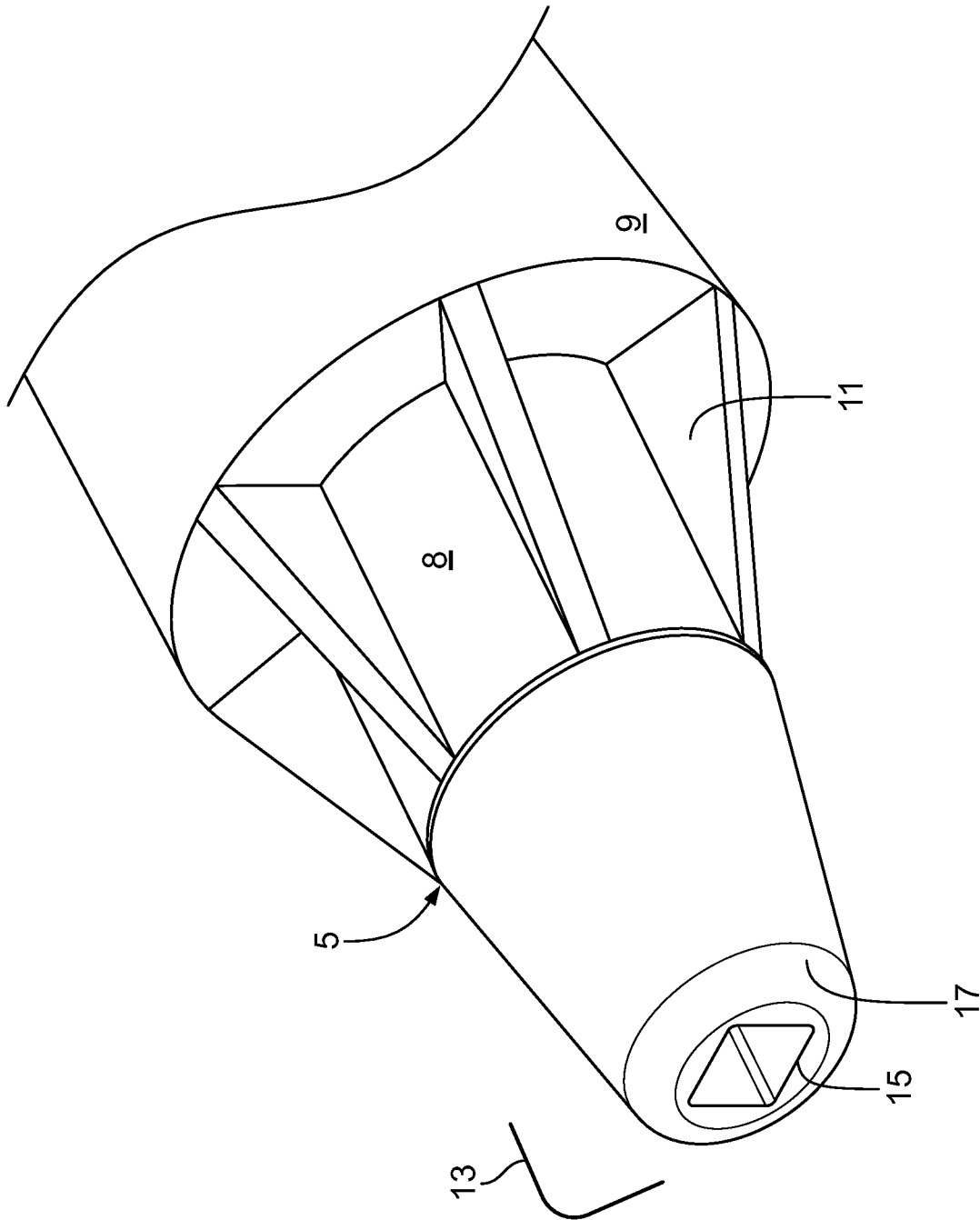

FIG. 1

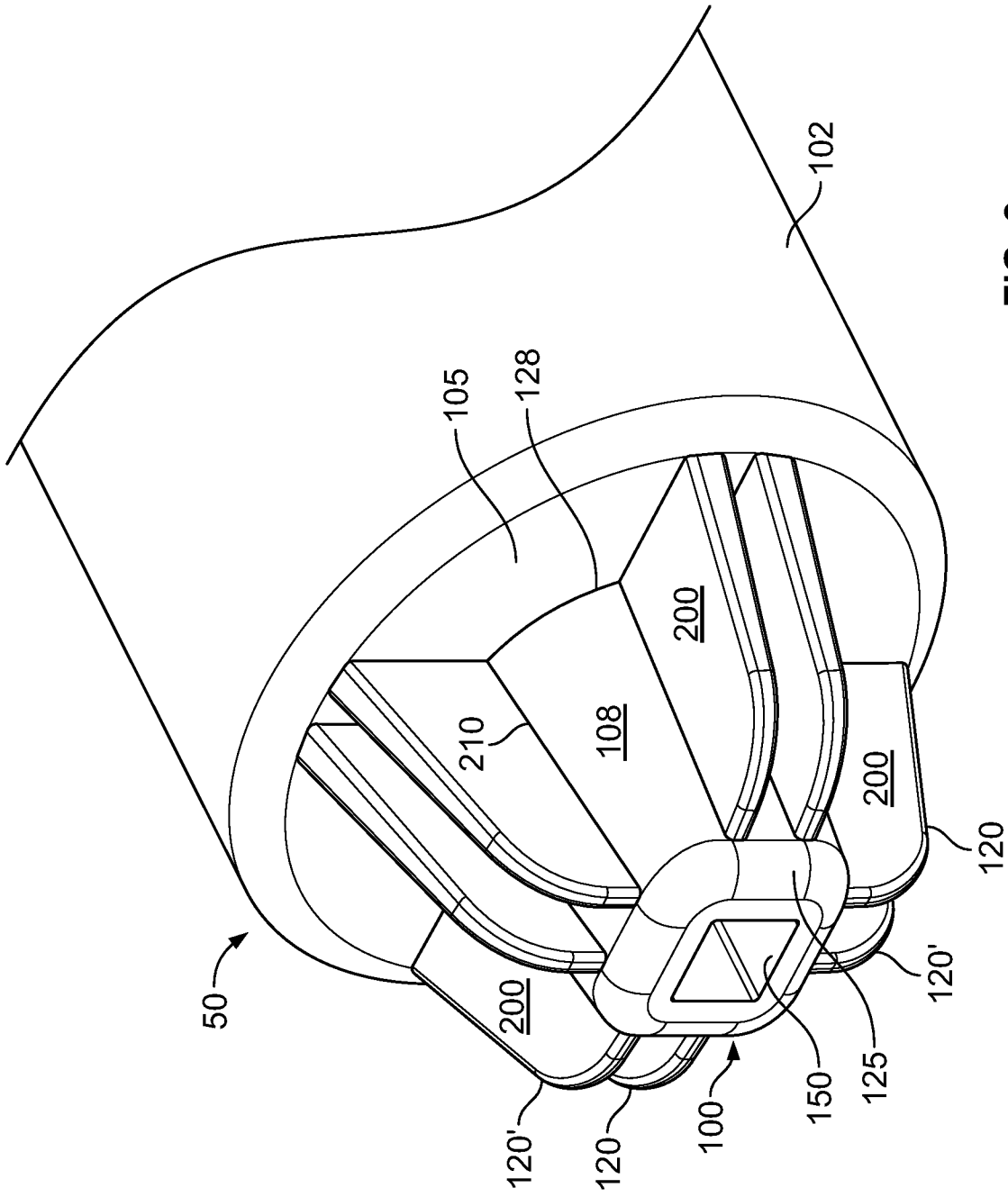

FIG. 2



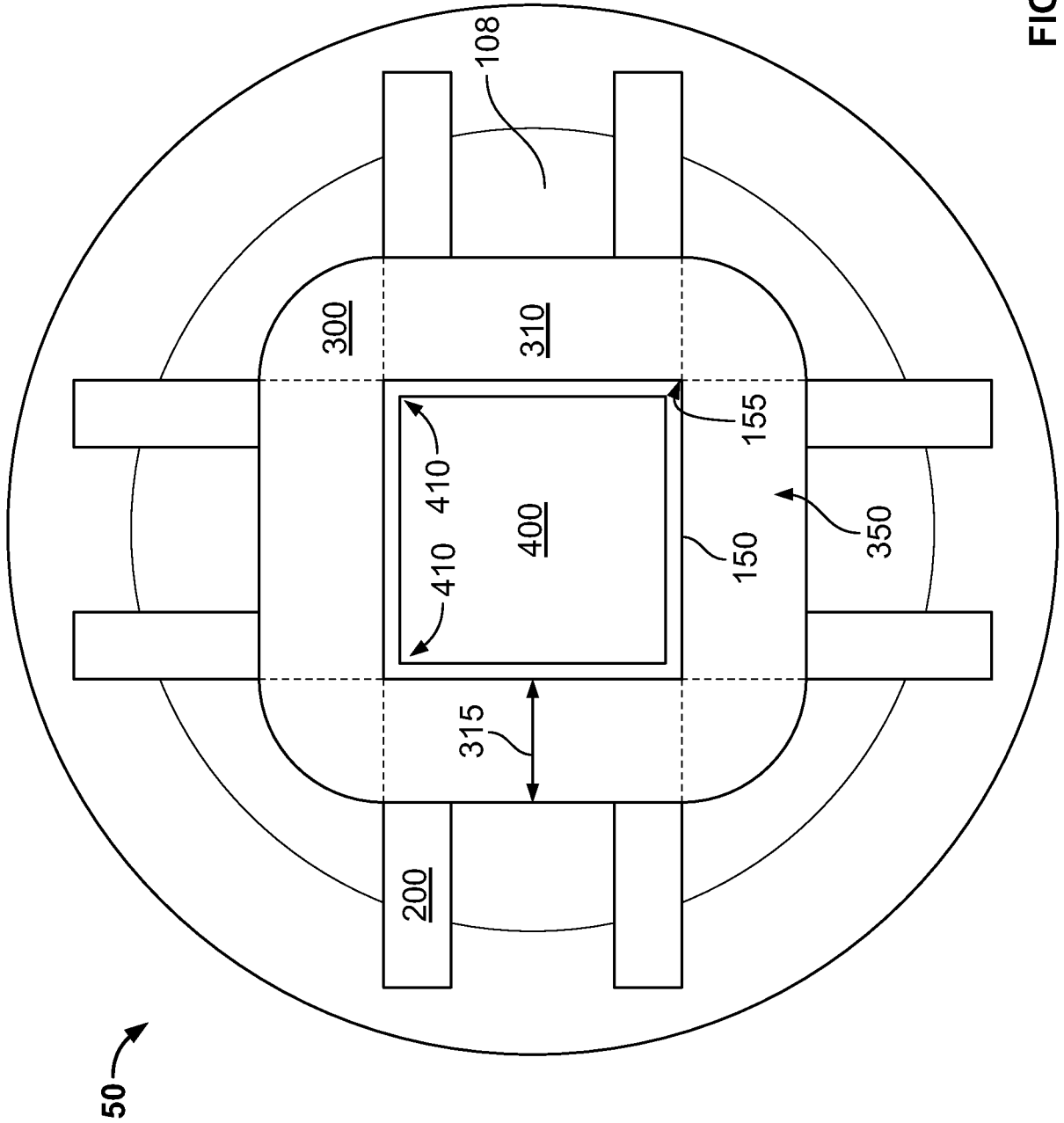

FIG. 5

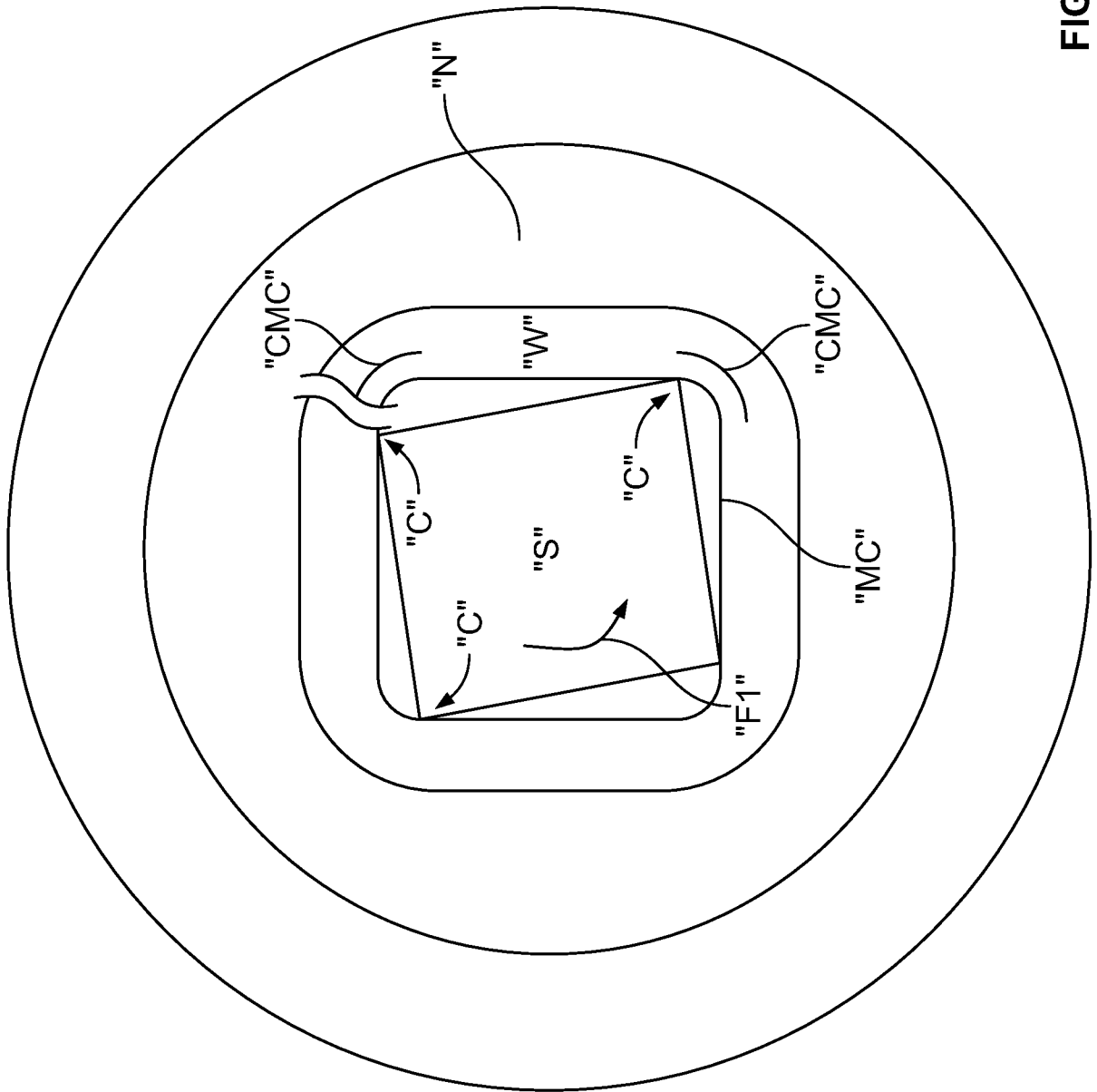
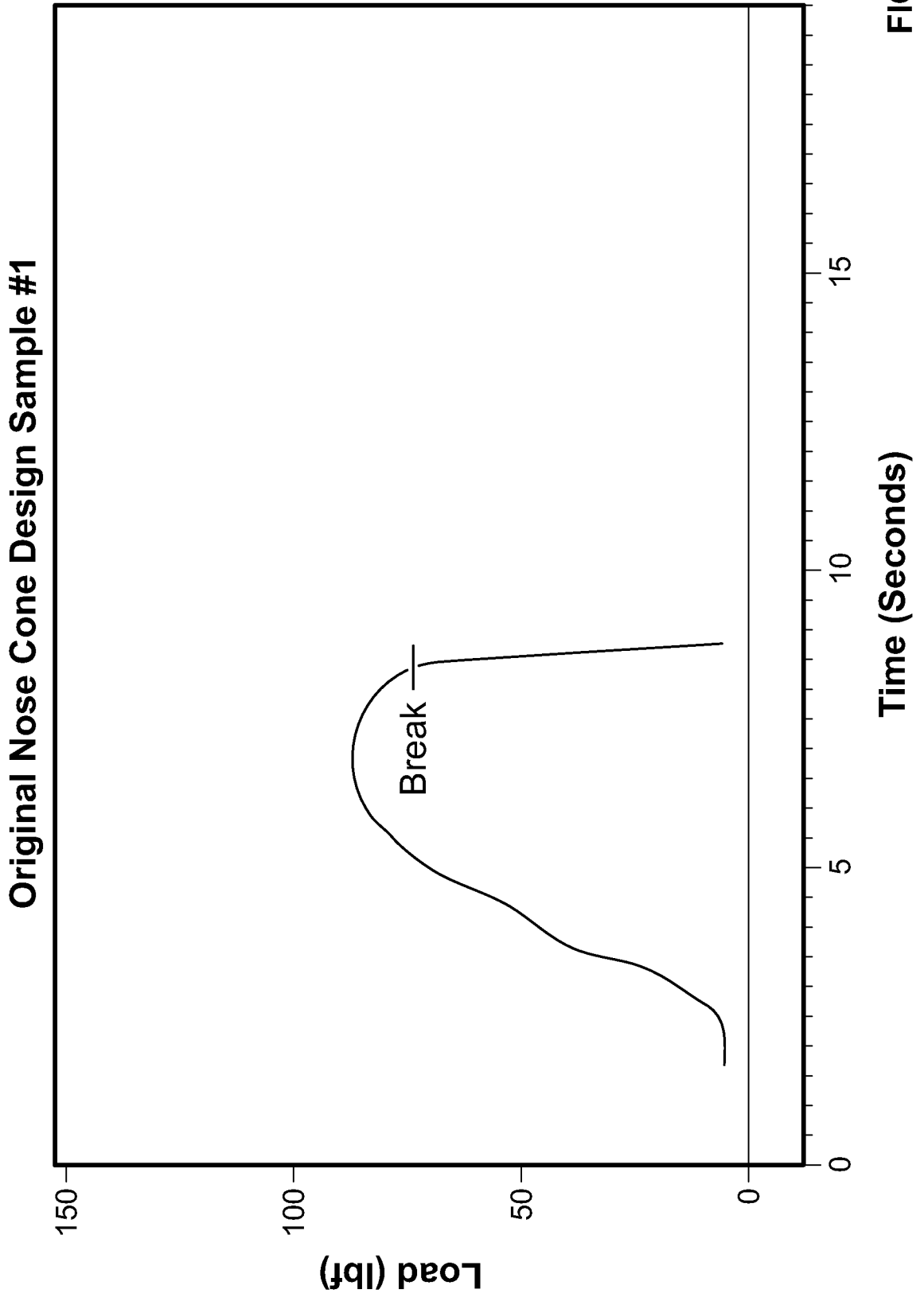
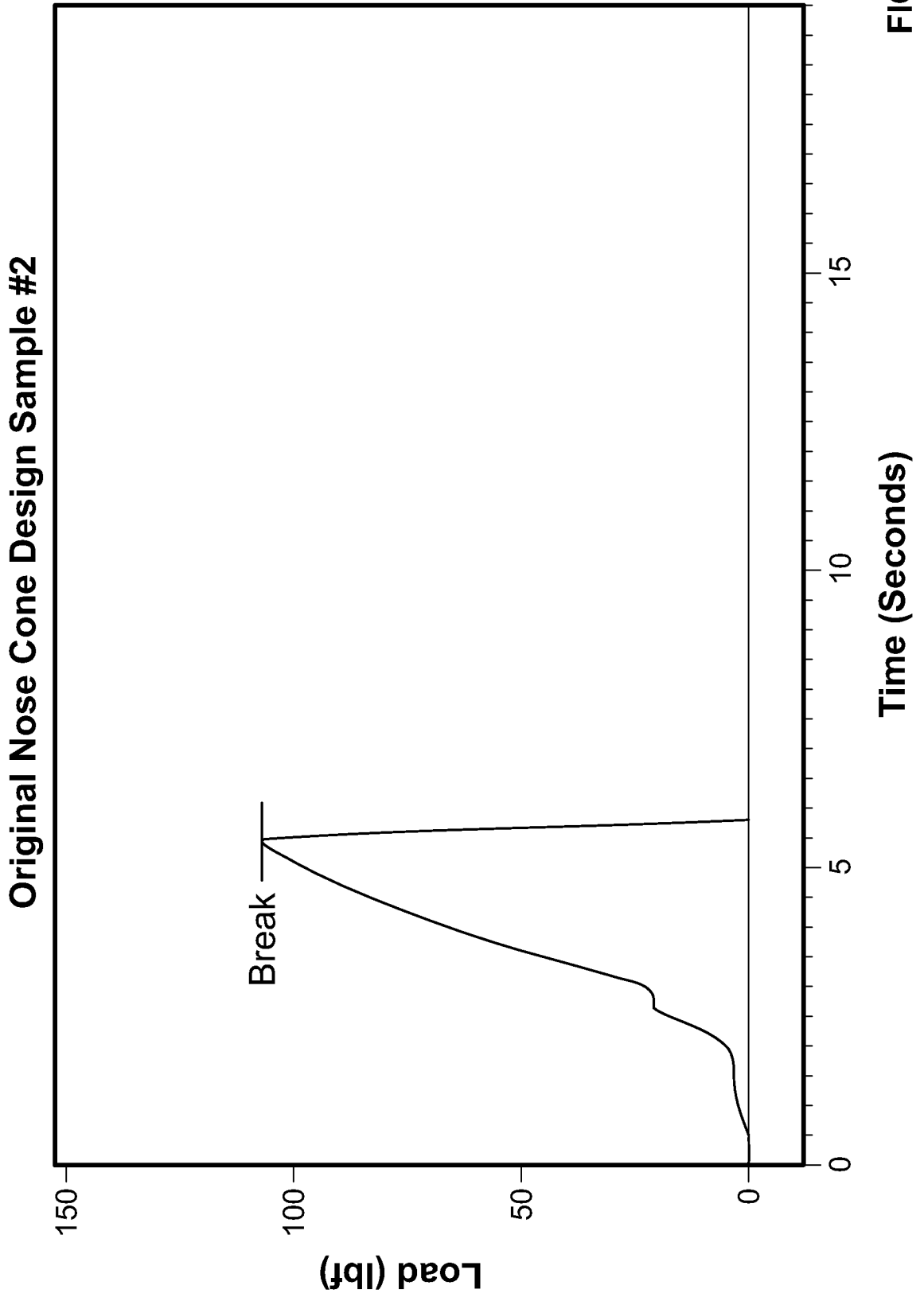
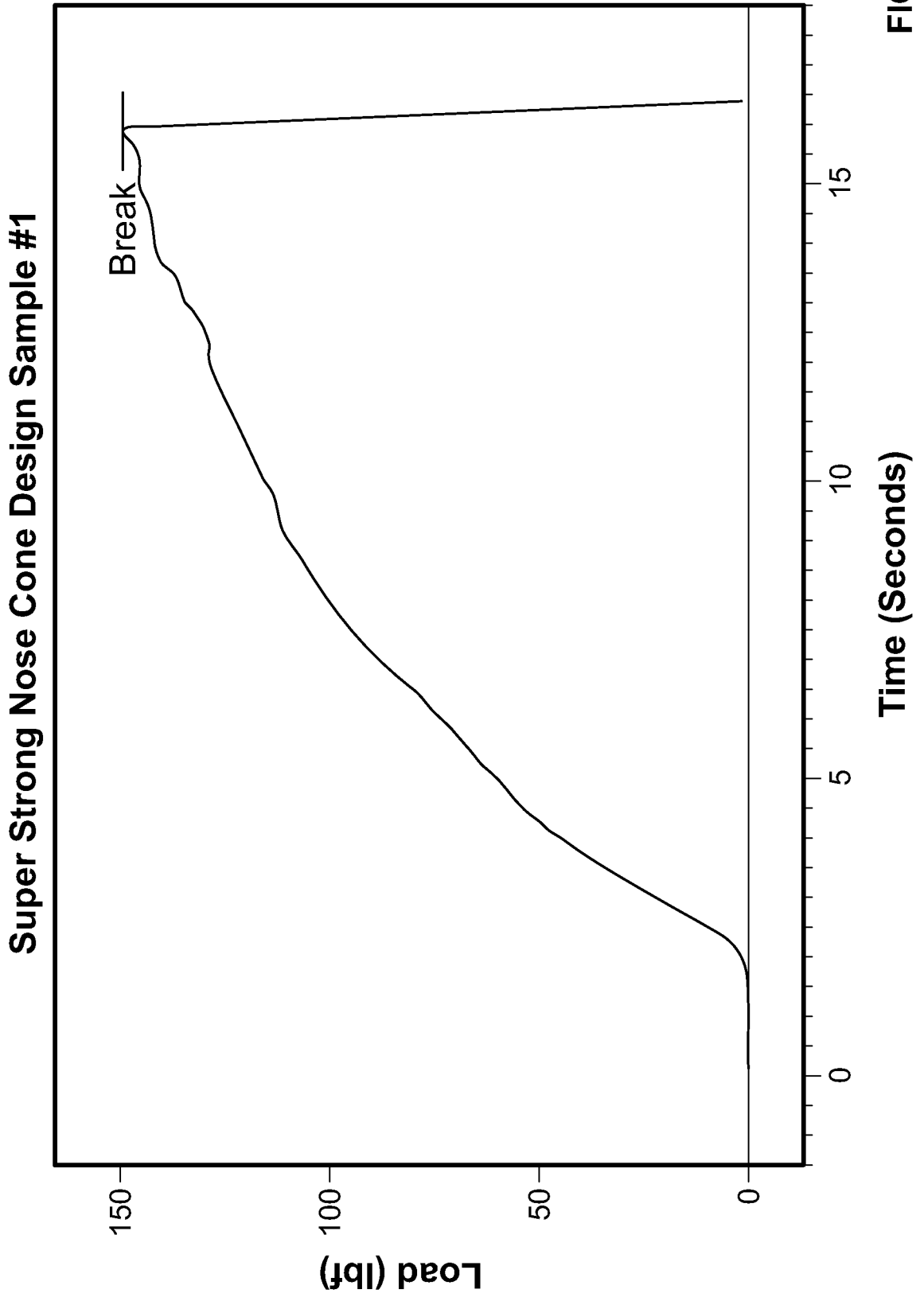

FIG. 6



**FIG. 7**





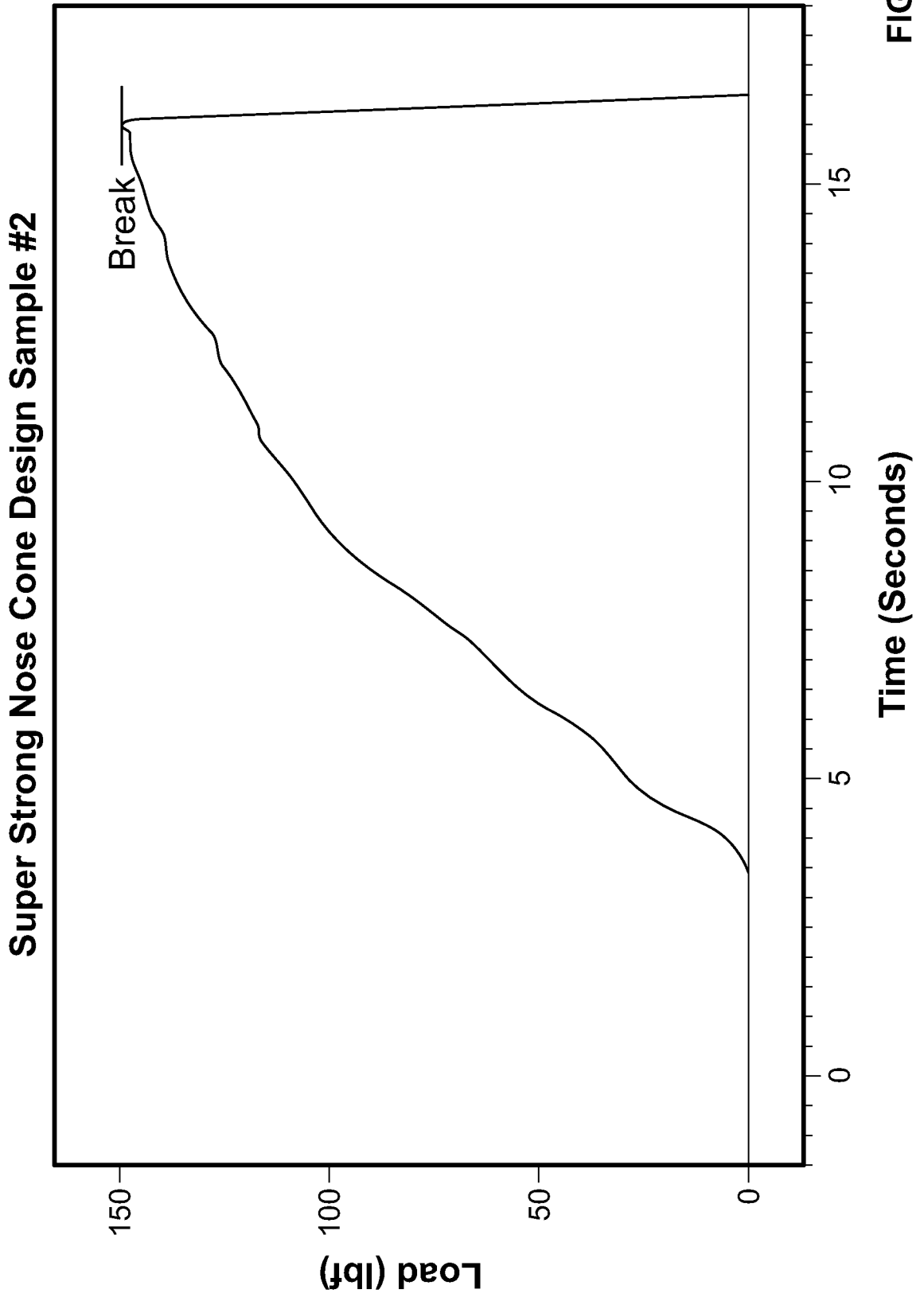

FIG. 10

## INTERNATIONAL SEARCH REPORT

International application No.  
**PCT/US2014/011719****A. CLASSIFICATION OF SUBJECT MATTER****A61B 17/56(2006.01)i, A61B 19/00(2006.01)i, A61C 3/00(2006.01)i**

According to International Patent Classification (IPC) or to both national classification and IPC

**B. FIELDS SEARCHED**

Minimum documentation searched (classification system followed by classification symbols)

A61B 17/56; E02D 27/00; B25B 23/14; A61B 17/16; B25B 23/157; E04B 1/24; A61B 17/88; A61B 19/00; A61C 3/00

Documentation searched other than minimum documentation to the extent that such documents are included in the fields searched

Korean utility models and applications for utility models

Japanese utility models and applications for utility models

Electronic data base consulted during the international search (name of data base and, where practicable, search terms used)

eKOMPASS(KIPO internal) &amp; Keywords: driver, ribs, torque, nose, wall, channel, square

**C. DOCUMENTS CONSIDERED TO BE RELEVANT**

Category*	Citation of document, with indication, where appropriate, of the relevant passages	Relevant to claim No.
X	WO 2012-112812 A2 (ECA MEDICAL INSTRUMENTS et al.) 23 August 2012 See paragraphs [0028], [0032], [0054], [0055]; figures 9, 10, 14A-14C.	1-19
A	US 2006-0179981 A1 (CUTLER, B. et al.) 17 August 2006 See paragraphs [0033], [0034]; figures 11, 12, 15.	1-19
A	JP 2001-311219 A (SEKISUI CHEM CO., LTD. et al.) 09 November 2001 See paragraph [0019]; figure 5.	1-19
A	US 2006-0278051 A1 (GAUTHIER, M. T. and LANDOWSKI, S. S.) 14 December 2006 See the whole document.	1-19
A	US 6132435 A (YOUNG, R. A.) 17 October 2000 See the whole document.	1-19

 Further documents are listed in the continuation of Box C. See patent family annex.

\* Special categories of cited documents:

"A" document defining the general state of the art which is not considered to be of particular relevance

"E" earlier application or patent but published on or after the international filing date

"L" document which may throw doubts on priority claim(s) or which is cited to establish the publication date of another citation or other special reason (as specified)

"O" document referring to an oral disclosure, use, exhibition or other means

"P" document published prior to the international filing date but later than the priority date claimed

"T" later document published after the international filing date or priority date and not in conflict with the application but cited to understand the principle or theory underlying the invention

"X" document of particular relevance; the claimed invention cannot be considered novel or cannot be considered to involve an inventive step when the document is taken alone

"Y" document of particular relevance; the claimed invention cannot be considered to involve an inventive step when the document is combined with one or more other such documents, such combination being obvious to a person skilled in the art

"&amp;" document member of the same patent family

Date of the actual completion of the international search

23 April 2014 (23.04.2014)

Date of mailing of the international search report

**01 May 2014 (01.05.2014)**

Name and mailing address of the ISA/KR

International Application Division  
Korean Intellectual Property Office  
189 Cheongsa-ro, Seo-gu, Daejeon Metropolitan City, 302-701,  
Republic of Korea

Facsimile No. +82-42-472-7140

Authorized officer

Han, Inho

Telephone No. +82-42-481-3362





**INTERNATIONAL SEARCH REPORT**

Information on patent family members

International application No.

**PCT/US2014/011719**

Patent document cited in search report	Publication date	Patent family member(s)	Publication date
WO 2012-112812 A2	23/08/2012	CA 2825095 A1 EP 2675594 A2 US 2012-198972 A1 US 2013-305889 A1 WO 2012-112812 A3	23/08/2012 25/12/2013 09/08/2012 21/11/2013 08/11/2012
US 2006-0179981 A1	17/08/2006	US 7272999 B2 WO 2005-077603 A1	25/09/2007 25/08/2005
JP 2001-311219 A	09/11/2001	None	
US 2006-0278051 A1	14/12/2006	US 2008-0016991 A1 US 7272998 B1 US 7650821 B2	24/01/2008 25/09/2007 26/01/2010
US 6132435 A	17/10/2000	AU 2000-64221 A1 AU 2000-64221 B2 CA 2408333 A1 CA 2663979 A1 EP 1212173 A1 JP 2003-509143 A WO 01-19571 A1	17/04/2001 17/10/2002 22/03/2001 22/03/2001 12/06/2002 11/03/2003 22/03/2001