



US00D791986S

(12) **United States Design Patent**
Lin

(10) **Patent No.:** **US D791,986 S**

(45) **Date of Patent:** **** Jul. 11, 2017**

(54) **PORTION OF A VEHICLE HEADLIGHT**

D717,979 S * 11/2014 Ueda D26/28
D717,982 S * 11/2014 Lai D26/28
D718,479 S * 11/2014 Lai D26/28

(71) Applicant: **KUEN HWA TRAFFIC INDUSTRIAL CO., LTD.**, Tainan (TW)

* cited by examiner

(72) Inventor: **Yung-Hsiang Lin**, Tainan (TW)

Primary Examiner — Marcus Jackson

(73) Assignee: **Kuen Hwa Traffic Industrial Co., Ltd.**, Tainan (TW)

(74) *Attorney, Agent, or Firm* — Rosenberg, Klein & Lee

(**) Term: **15 Years**

(57) **CLAIM**

(21) Appl. No.: **29/561,198**

The ornamental design for a portion of a vehicle headlight, as shown and described.

(22) Filed: **Apr. 14, 2016**

(51) **LOC (10) Cl.** **26-06**

(52) **U.S. Cl.**
USPC **D26/28**

DESCRIPTION

(58) **Field of Classification Search**
USPC D26/28–36; 362/80–83, 267–269, 362/459–468, 475–478, 485–487
CPC F21S 48/00; F21S 48/10; F21S 48/115; F21S 48/1233; F21S 48/1266; F21S 48/1388; F21S 48/2268; F21V 21/04
See application file for complete search history.

FIG. 1 is a perspective view of a portion of a vehicle headlight showing my present design;
FIG. 2 is a front view thereof;
FIG. 3 is a right view thereof;
FIG. 4 is a top plan view thereof;
FIG. 5 is a bottom view thereof; and,
FIG. 6 is another perspective view thereof.

(56) **References Cited**

U.S. PATENT DOCUMENTS

The broken lines in the drawings illustrate portions of the portion of a vehicle headlight which form no part of the claimed design.

D538,954 S * 3/2007 Pfeiffer D26/28
D552,768 S * 10/2007 Leclercq D26/28

1 Claim, 6 Drawing Sheets

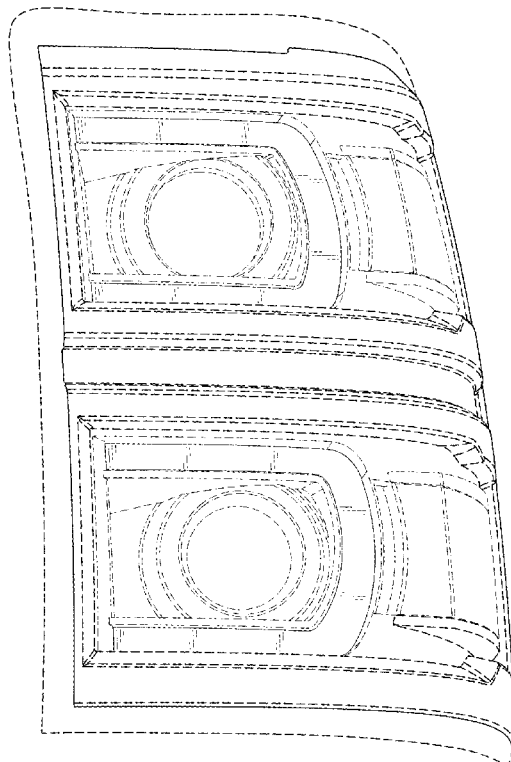

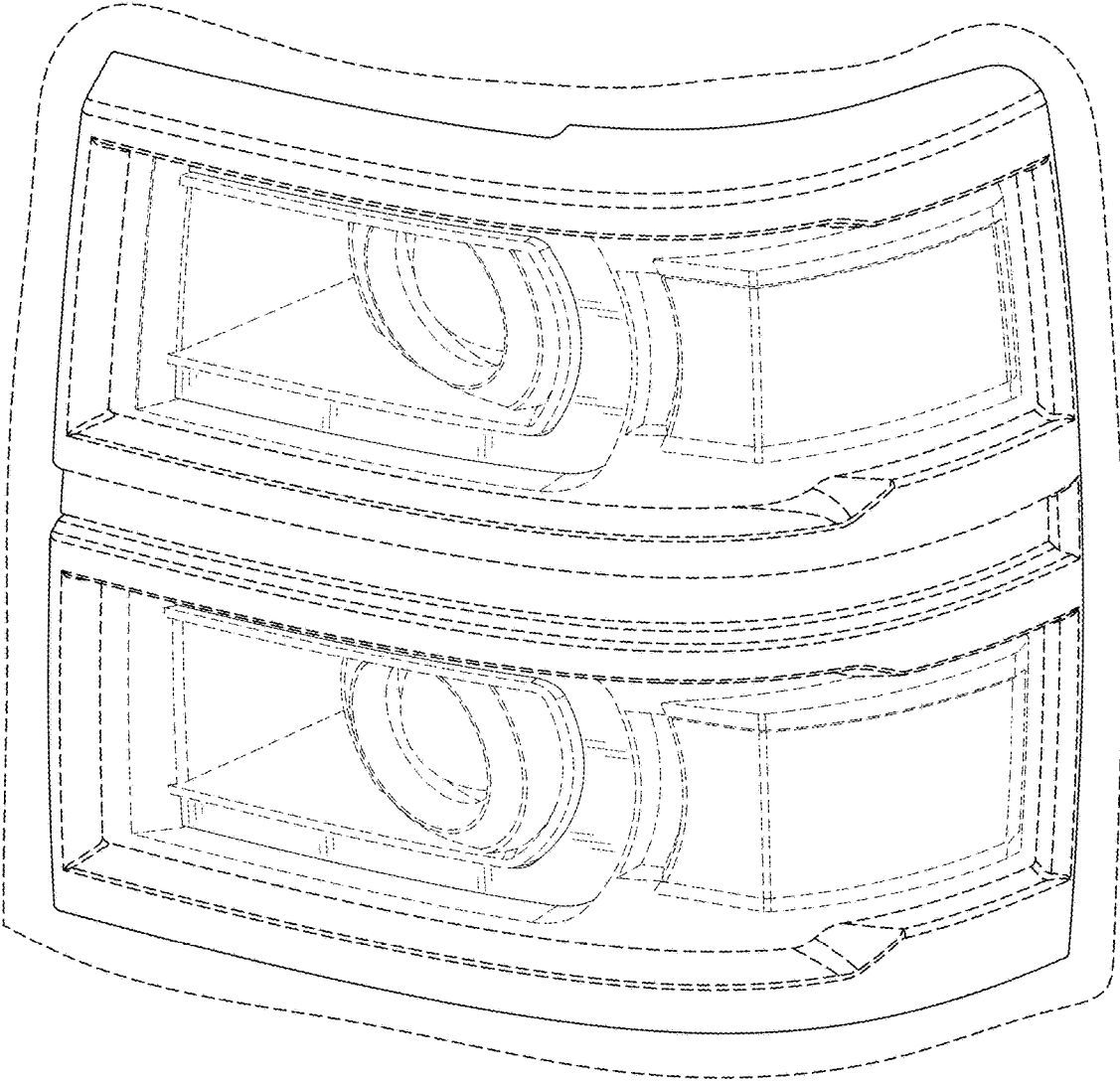

FIG. 1

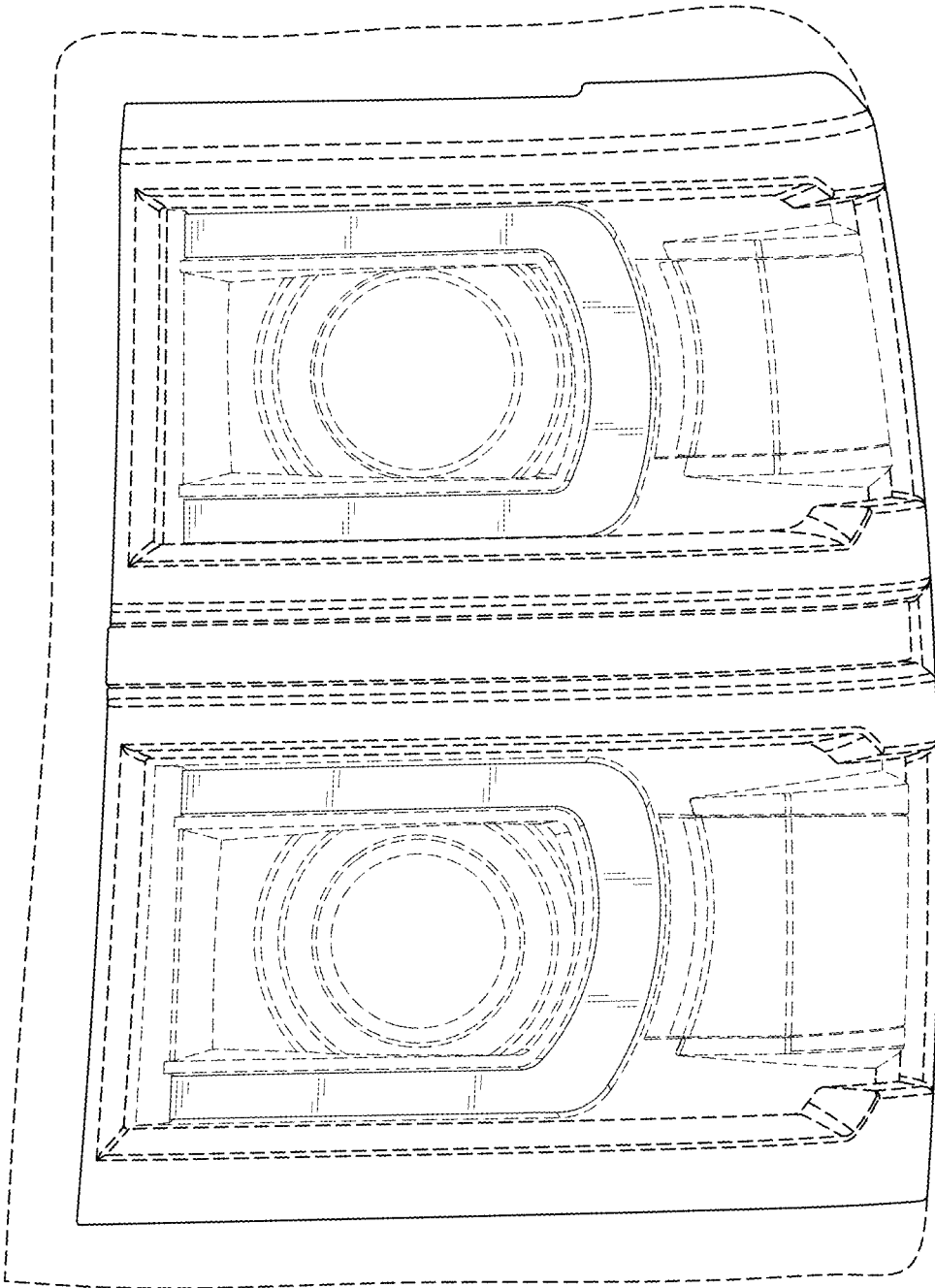

FIG. 2

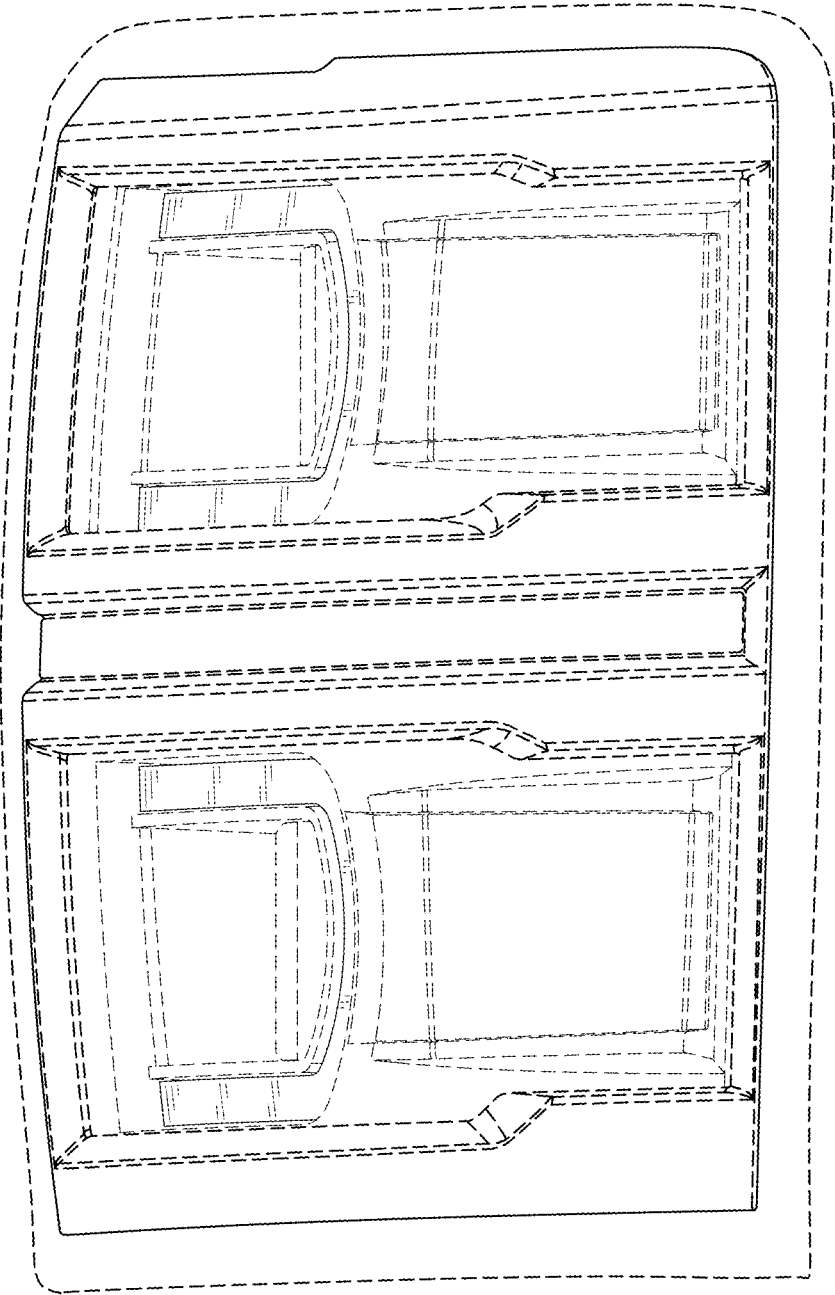

FIG. 3

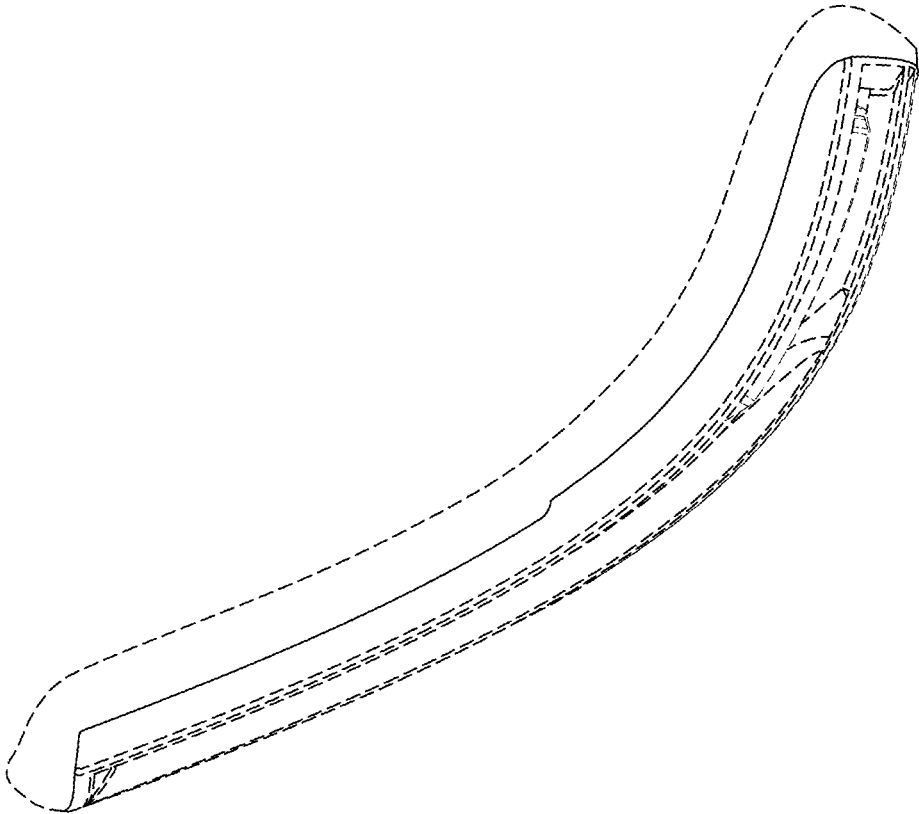
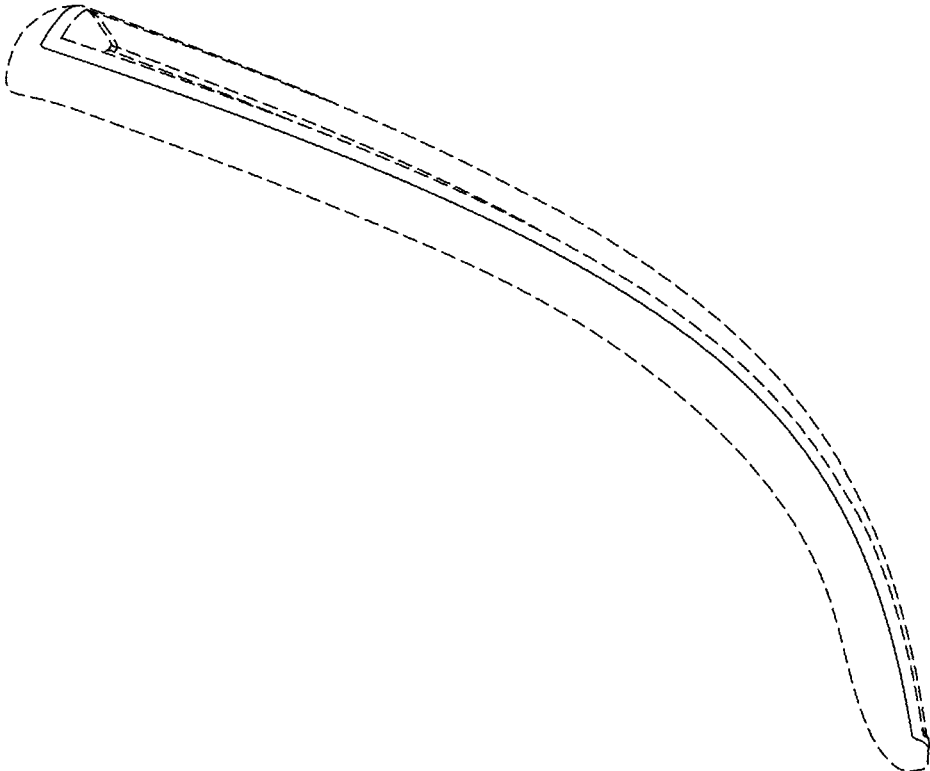

FIG. 4



F I G . 5

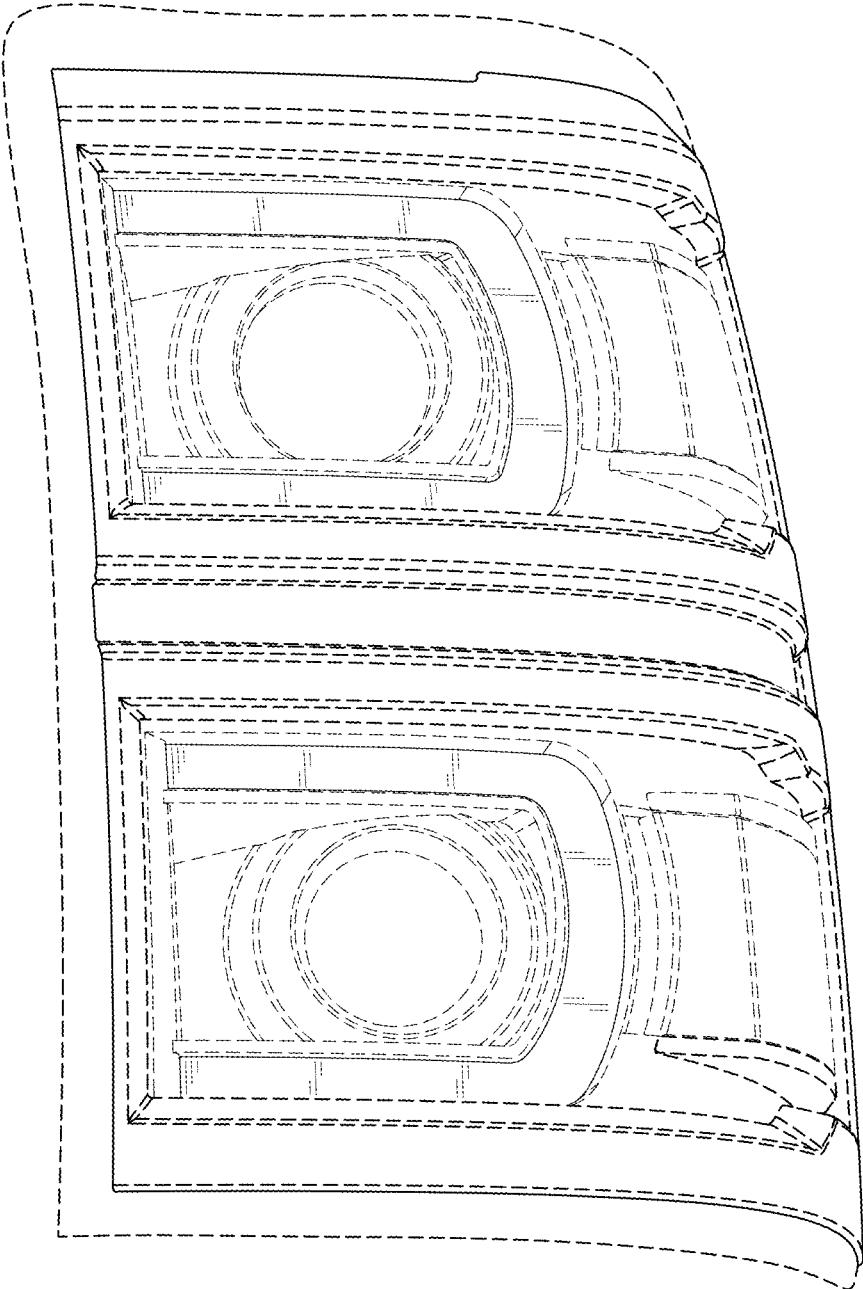

FIG. 6