



(12) **United States Design Patent**  
**Lam**

(10) **Patent No.:** **US D1,022,326 S**  
(45) **Date of Patent:** **\*\* Apr. 9, 2024**

(54) **HANDHELD GEL NAIL UV CURING LIGHT WITH SILICON STAMPER**

(71) Applicant: **Sonny Truong Lam**, Morganton, NC (US)

(72) Inventor: **Sonny Truong Lam**, Morganton, NC (US)

(\*\*) Term: **15 Years**

(21) Appl. No.: **29/829,614**

(22) Filed: **Mar. 7, 2022**

(51) **LOC (14) Cl.** ..... **28-03**

(52) **U.S. Cl.** ..... **D28/58**  
USPC ..... **D28/58**

(58) **Field of Classification Search**  
USPC ..... D28/54.1, 56, 57, 58, 62; 132/73, 73.5  
CPC ..... A45D 29/00; A45D 29/18; A45D 29/20; A45D 2029/008; A45D 2200/00; A45D 2200/205; F26B 3/28  
See application file for complete search history.

(56) **References Cited**

**U.S. PATENT DOCUMENTS**

D687,600	S	*	8/2013	Cheng	.....	D28/54.1
D707,888	S	*	6/2014	Kim	.....	D28/54.1
D759,893	S	*	6/2016	Troska	.....	D28/58
10,827,815	B1	*	11/2020	Tan	.....	A45D 29/18
D965,223	S	*	9/2022	Huang	.....	D28/58
D990,050	S	*	6/2023	Gong	.....	D28/58
D992,205	S	*	7/2023	Wu	.....	D28/58

(Continued)

**FOREIGN PATENT DOCUMENTS**

CN	306633163	*	6/2021
CN	307744188	*	12/2022

(Continued)

**OTHER PUBLICATIONS**

Chumia Mini UV LED Nail Lamp [online], [publication date is Nov. 8, 2021]. [Retrieved from the internet on Jan. 4, 2024]. URL: <<https://www.amazon.com/Cuticle-Pusher-Portable-Stainless-Manicure/dp/B09L84114F/ref>>. (Year: 2021).\*

(Continued)

*Primary Examiner* — Karen E Eldridge Powers  
*Assistant Examiner* — Margaret Leah Bryan  
(74) *Attorney, Agent, or Firm* — Brennan, Manna & Diamond, LLC

(57) **CLAIM**

I claim the ornamental design for a handheld gel nail UV curing light with silicone stamper, as shown and described.

**DESCRIPTION**

FIG. 1 is a top perspective view of the handheld gel nail UV curing light with silicone stamper of the present invention; FIG. 2 is a bottom perspective view of the handheld gel nail UV curing light with silicone stamper of the present invention; FIG. 3 is a front elevational view of the handheld gel nail UV curing light with silicone stamper of the present invention; FIG. 4 is a right hand side elevational view of the handheld gel nail UV curing light with silicone stamper of the present invention; FIG. 5 is a rear elevational view of the handheld gel nail UV curing light with silicone stamper of the present invention; FIG. 6 is a left hand side elevational view of the handheld gel Nail UV curing light with silicone stamper of the present invention; FIG. 7 is a top view of the handheld gel nail UV curing light with silicone stamper of the present invention; and, FIG. 8 is a bottom view of the handheld gel nail UV curing light with silicone stamper of the present invention.

**1 Claim, 7 Drawing Sheets**

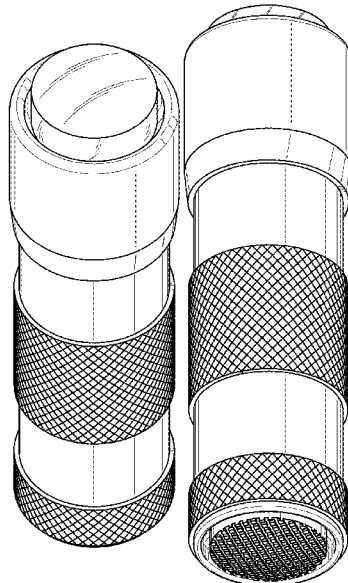

(56)

**References Cited**

U.S. PATENT DOCUMENTS

D1,009,369 S \* 12/2023 He ..... D28/58  
2023/0200513 A1 \* 6/2023 Lam ..... A45D 29/00  
132/73

FOREIGN PATENT DOCUMENTS

CN 307930005 \* 3/2023  
KR 301189968.0000 \* 11/2022

OTHER PUBLICATIONS

Freeorr Mini UV Light Presser [online], [publication date is Apr. 7, 2022]. [Retrieved from the internet on Jan. 4, 2024]. URL: <<https://www.amazon.com/Replacement-Portable-Temporary-Perfectly-Decoration/dp/B09G6PPFT4/ref>>. (Year: 2022).\*

SLinnovation Mini UV Nail Lamp [online], [publication date is May 31, 2022]. [Retrieved from the internet on Jan. 4, 2024]. URL: <<https://www.amazon.com/SLinnovation-Mini-Light-Nails-Battery-Powered/dp/B0B2VLDJLD/ref>>. (Year: 2022).\*

Aiseely UV Light for Nails [online], [publication date is Jul. 15, 2022]. [Retrieved from the internet on Jan. 4, 2024]. URL: <<https://www.amazon.com/Portable-Flashlights-Light-Nails-Rechargeable/dp/B0B6P1LXFV/ref>>. (Year: 2022).\*

\* cited by examiner

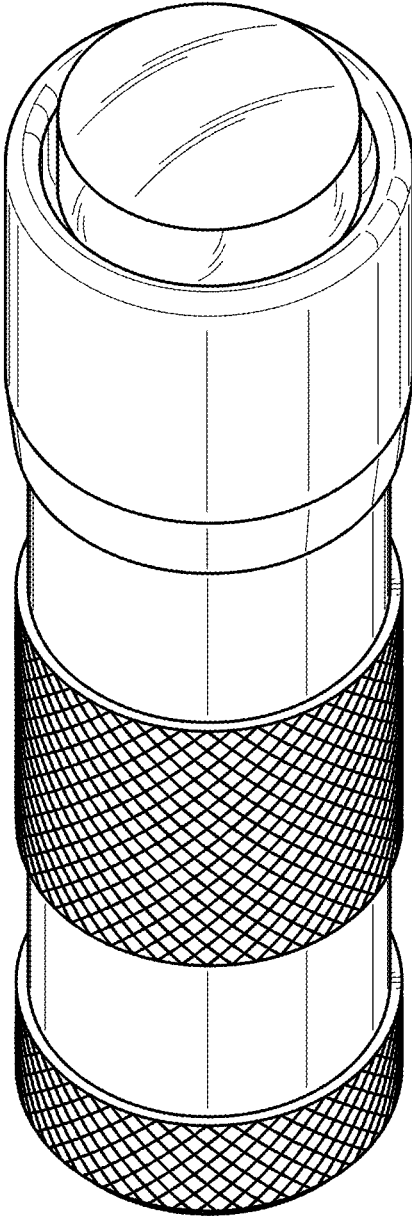

**FIG. 1**

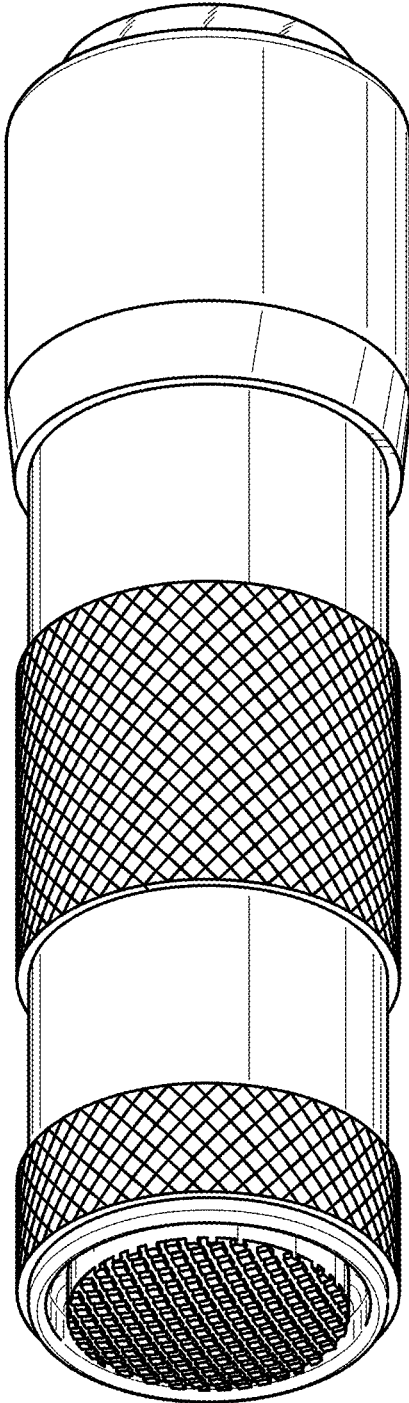

**FIG. 2**

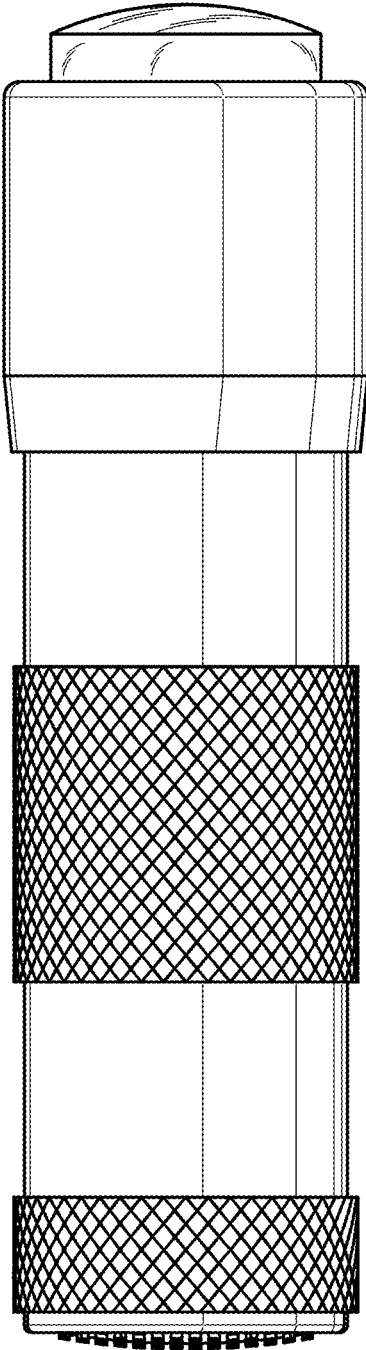

FIG. 3

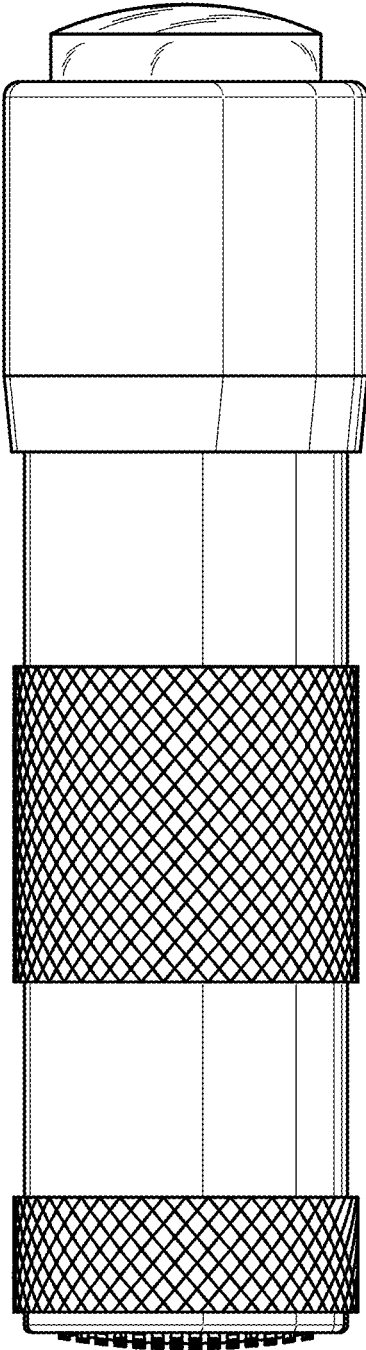

FIG. 4

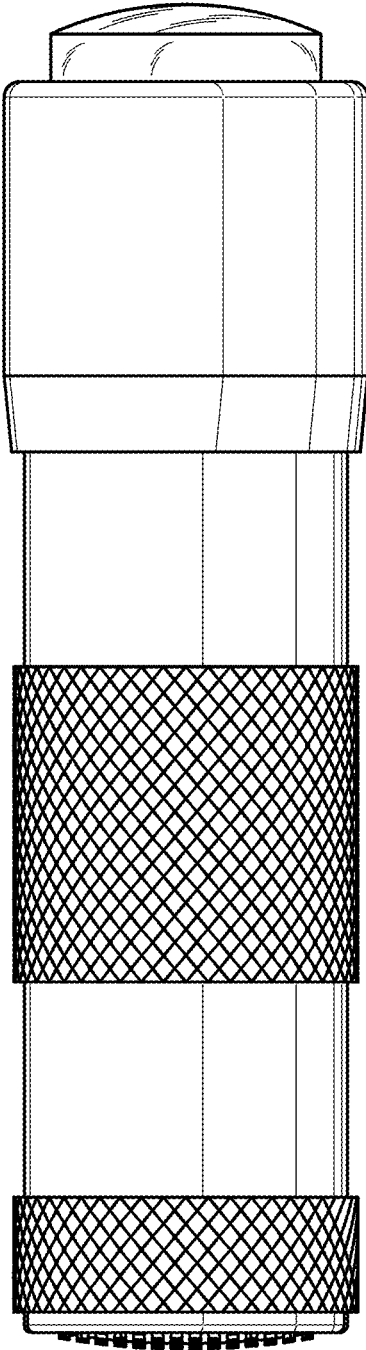

FIG. 5

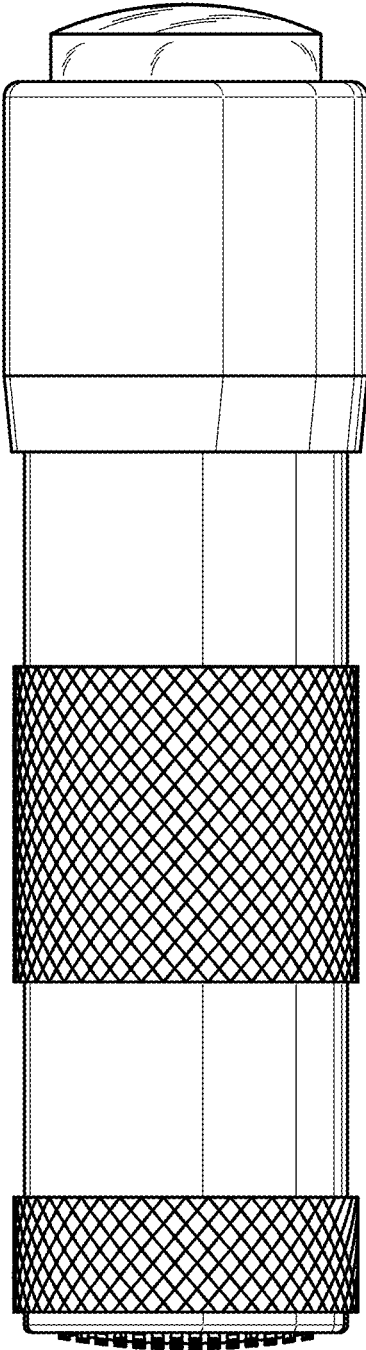
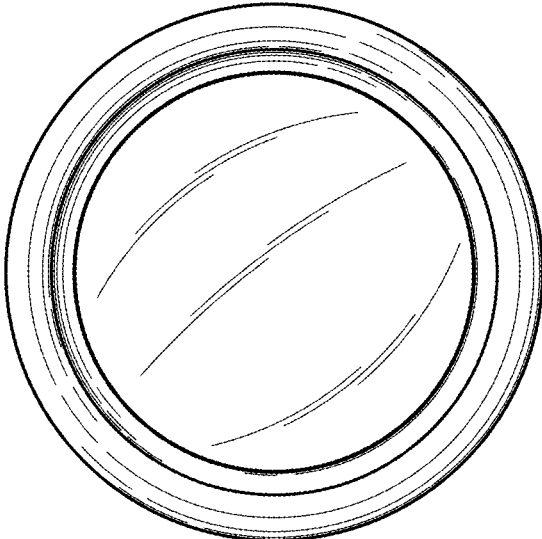
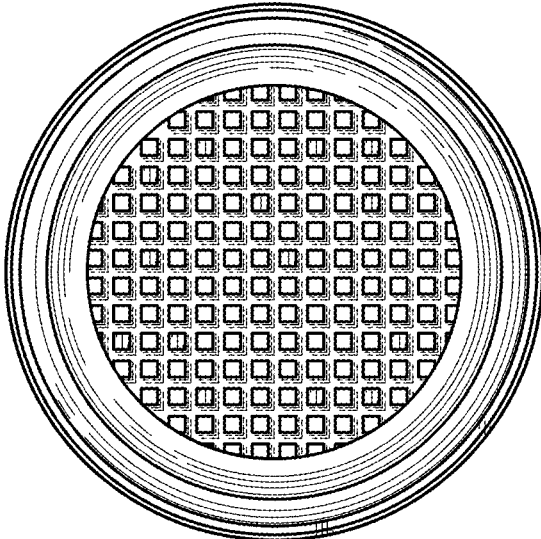

FIG. 6



**FIG. 7**



**FIG. 8**