



US00D692798S

(12) **United States Design Patent**
Thurber

(10) **Patent No.:** **US D692,798 S**

(45) **Date of Patent:** **** Nov. 5, 2013**

(54) **VEHICLE BODY**

D644,147 S 8/2011 Suh et al.
D673,483 S * 1/2013 Yamada et al. D12/91
D674,726 S * 1/2013 Yamada et al. D12/91

(75) Inventor: **Joshua L. Thurber**, Macomb, MI (US)

(73) Assignee: **GM Global Technology Operations LLC**, Detroit, MI (US)

(**) Term: **14 Years**

(21) Appl. No.: **29/416,870**

(22) Filed: **Mar. 28, 2012**

(51) **LOC (9) Cl.** **12-08**

(52) **U.S. Cl.**
USPC **D12/91**

(58) **Field of Classification Search**
USPC D12/86, 90-92; D21/424, 433, 434;
296/181.1, 181.5

See application file for complete search history.

(56) **References Cited**

U.S. PATENT DOCUMENTS

D605,978 S 12/2009 Wolff et al.
D608,690 S 1/2010 Folden et al.
D608,691 S 1/2010 Zak, Jr. et al.
D613,645 S 4/2010 Song et al.
D627,262 S 11/2010 Ikeda et al.
D635,488 S 4/2011 Phipps

OTHER PUBLICATIONS

U.S. Appl. No. 29/406,032; filed Nov. 9, 2011; First Named Inventor: In Ho Song; Title: Vehicle Body.
Design U.S. Appl. No. 29/406,041; filed Nov. 9, 2011; First Named Inventor: Morio Ikeda; Title: Vehicle Body.

* cited by examiner

Primary Examiner — Melody Brown
(74) *Attorney, Agent, or Firm* — Reising Ethington PC; Lionel D. Anderson

(57) **CLAIM**
The ornamental design for a vehicle body, as shown and described.

DESCRIPTION

FIG. 1 is a front view of a vehicle body;
FIG. 2 is a perspective view of the vehicle body;
FIG. 3 is a top view of the vehicle body;
FIG. 4 is a right side view of the vehicle body;
FIG. 5 is another perspective view of the vehicle body; and,
FIG. 6 is a rear view of the vehicle body.
In the drawings, the portions shown by broken lines form no part of the claimed design; and, the left side view of the vehicle body is omitted because—except that the left side view does not have a gas cap cover—the left side view is identical to the right side view.

1 Claim, 6 Drawing Sheets

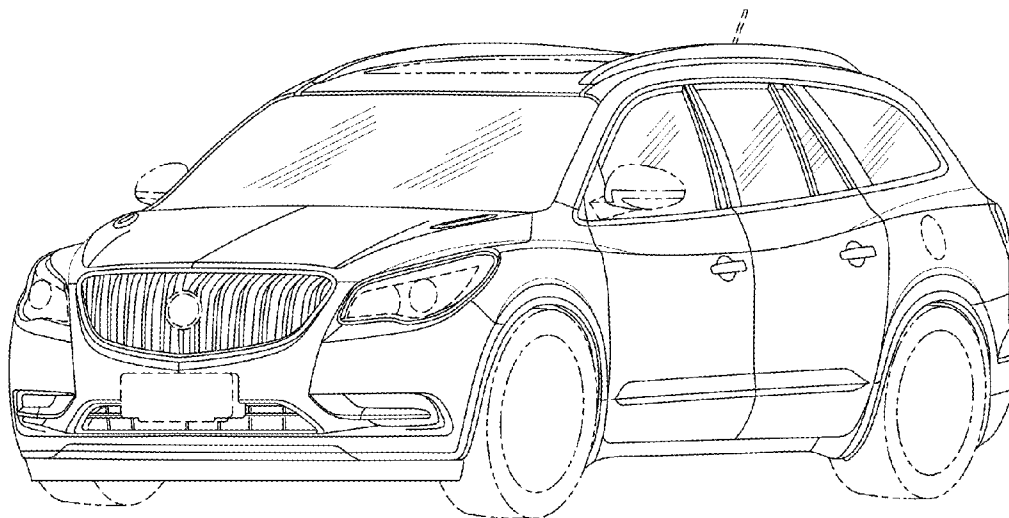

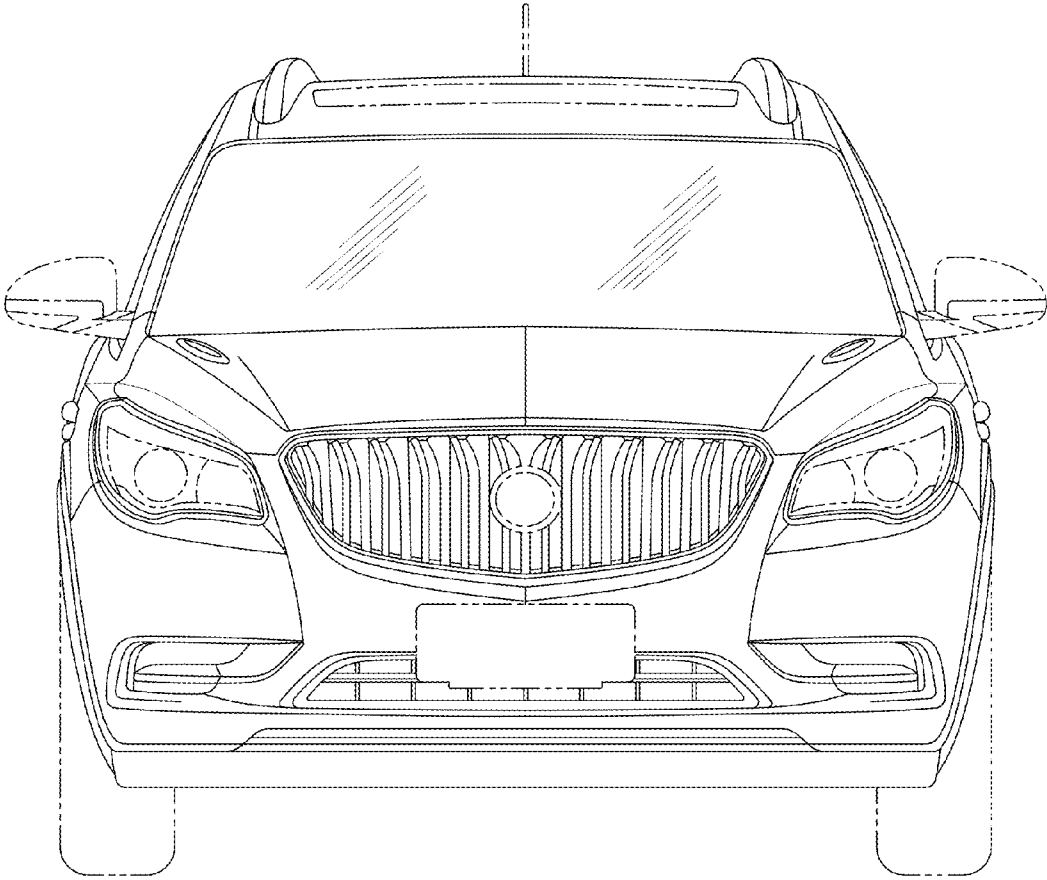

Fig-1

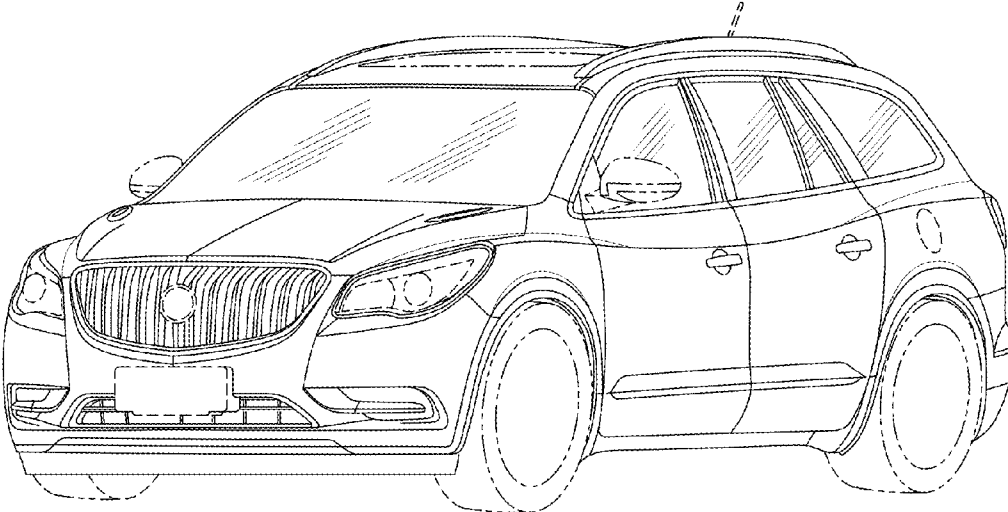

Fig-2

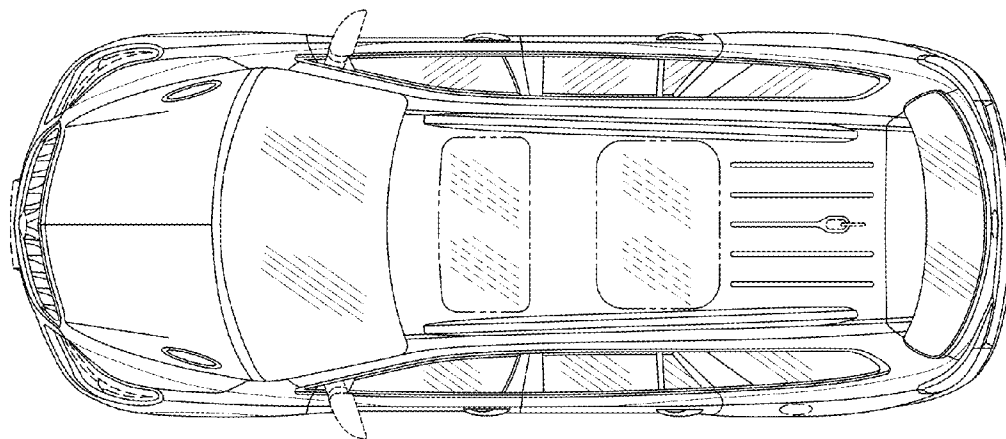

Fig-3

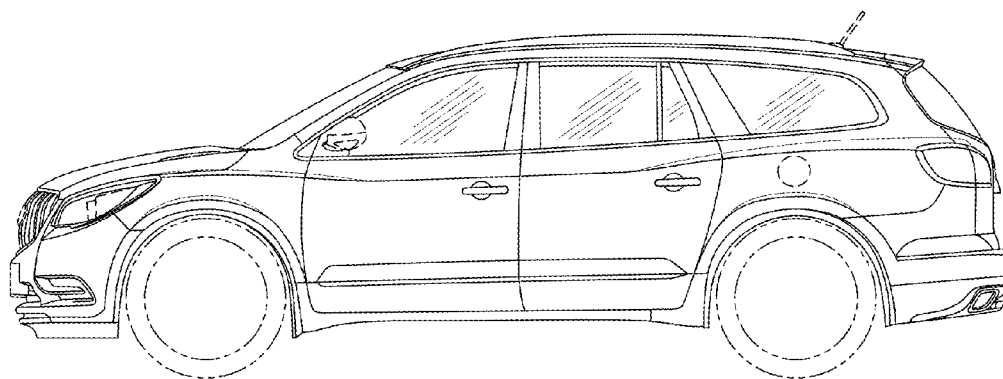

Fig-4

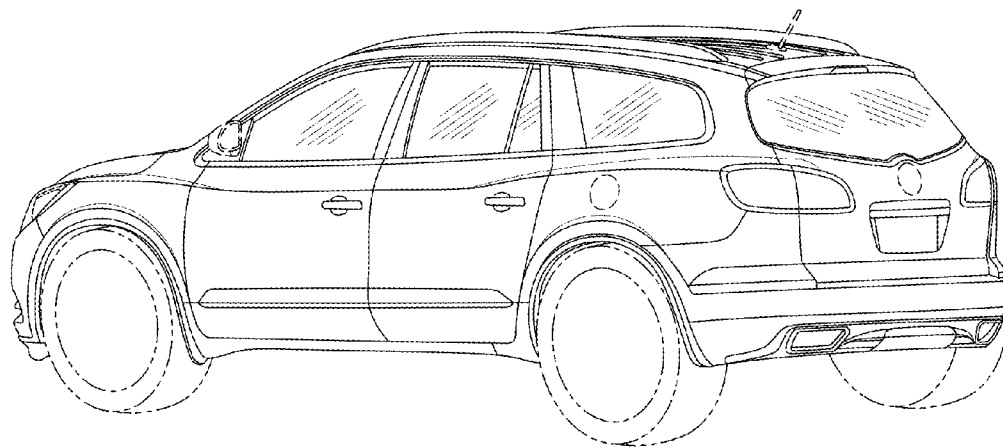

Fig-5

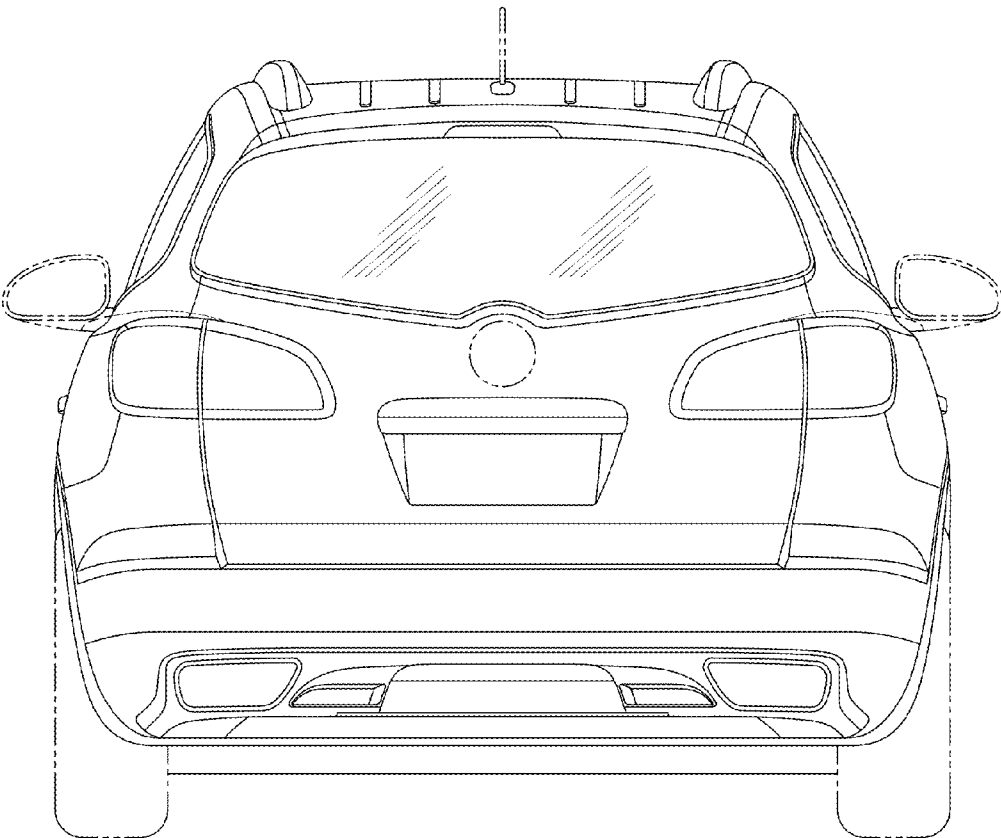

Fig-6