



US00D592857S

(12) **United States Design Patent**
Bohannon et al.

(10) **Patent No.:** **US D592,857 S**

(45) **Date of Patent:** **** May 26, 2009**

(54) **CLEANING DEVICE FOR GOLF EQUIPMENT**

(75) Inventors: **Jeremiah Bohannon**, Emerald Hills, CA (US); **Darrell S. Staley**, Santa Clara, CA (US)

(73) Assignee: **Frogger**, Emerald Hills, CA (US)

(**) Term: **14 Years**

(21) Appl. No.: **29/318,258**

(22) Filed: **May 16, 2008**

Related U.S. Application Data

(63) Continuation-in-part of application No. 11/517,508, filed on Sep. 8, 2006.

(51) **LOC (9) Cl.** **04-01**

(52) **U.S. Cl.** **D4/118; D4/121**

(58) **Field of Classification Search** D4/116,
D4/118, 121, 132, 134, 136, 138; D21/795;
15/111, 113, 159.1, 160, 161, 186-188, 236.01,
15/237

See application file for complete search history.

(56) **References Cited**

U.S. PATENT DOCUMENTS

2,368,988	A *	2/1945	Honhart	15/185
D190,333	S *	5/1961	Gunderson	D4/118
3,105,257	A *	10/1963	Blagden	15/105
D305,962	S *	2/1990	Ibanez	D4/116
5,230,117	A *	7/1993	Johnson et al.	15/106
6,095,934	A *	8/2000	Ohama	473/408
7,100,230	B2 *	9/2006	Hillenbrand	7/156
7,437,793	B2 *	10/2008	Lane	15/113

* cited by examiner

Primary Examiner—Melanie H Tung
Assistant Examiner—Lavone D Tabor
(74) *Attorney, Agent, or Firm*—Charter IP, LLC; Matthew J. Lattig

(57) **CLAIM**

The ornamental design for a cleaning device for golf equipment, as shown and described.

DESCRIPTION

FIG. 1 is a perspective view of a cleaning device for golf equipment showing my our new design.

FIG. 2 is a front elevational view thereof.

FIG. 3 is a rear elevational view thereof.

FIG. 4 is a right-side elevational view thereof, the left-side elevational view being a mirror image of the right-side elevational view and therefore not illustrated.

FIG. 5 is a top plan view thereof.

FIG. 6 is a bottom plan view thereof.

FIG. 7 is a perspective view thereof with the scraper block in the rotated, extended position of use.

FIG. 8 is a front elevational view thereof of the device as shown in FIG. 7.

FIG. 9 is a rear elevational view thereof of the device as shown in FIG. 7.

FIG. 10 is a right-side elevational view thereof of the device as shown in FIG. 7, the left-side elevational view being a mirror image of the right-side elevational view and therefore not illustrated.

FIG. 11 is a top plan view thereof of the device as shown in FIG. 7; and,

FIG. 12 is a bottom plan view thereof of the device as shown in FIG. 7.

1 Claim, 8 Drawing Sheets

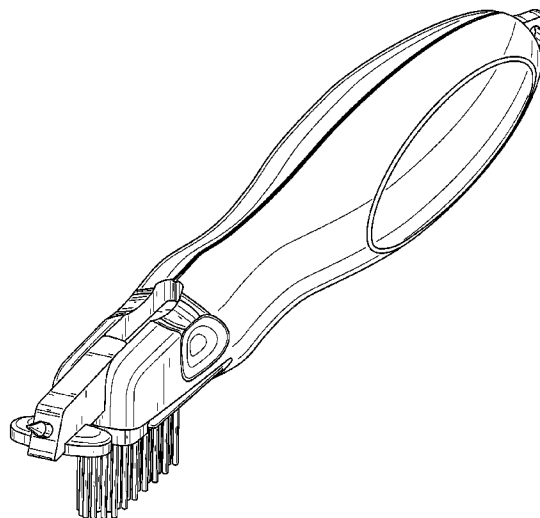
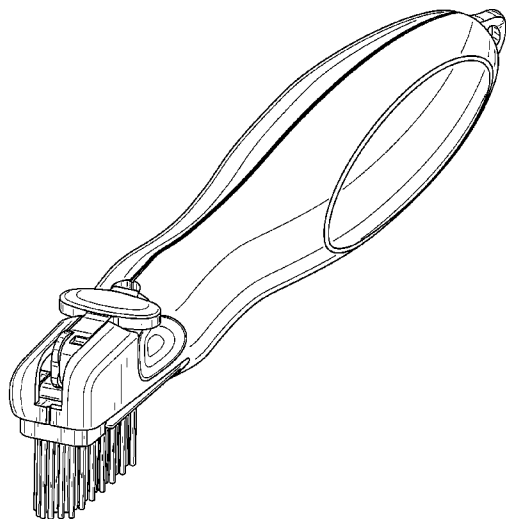

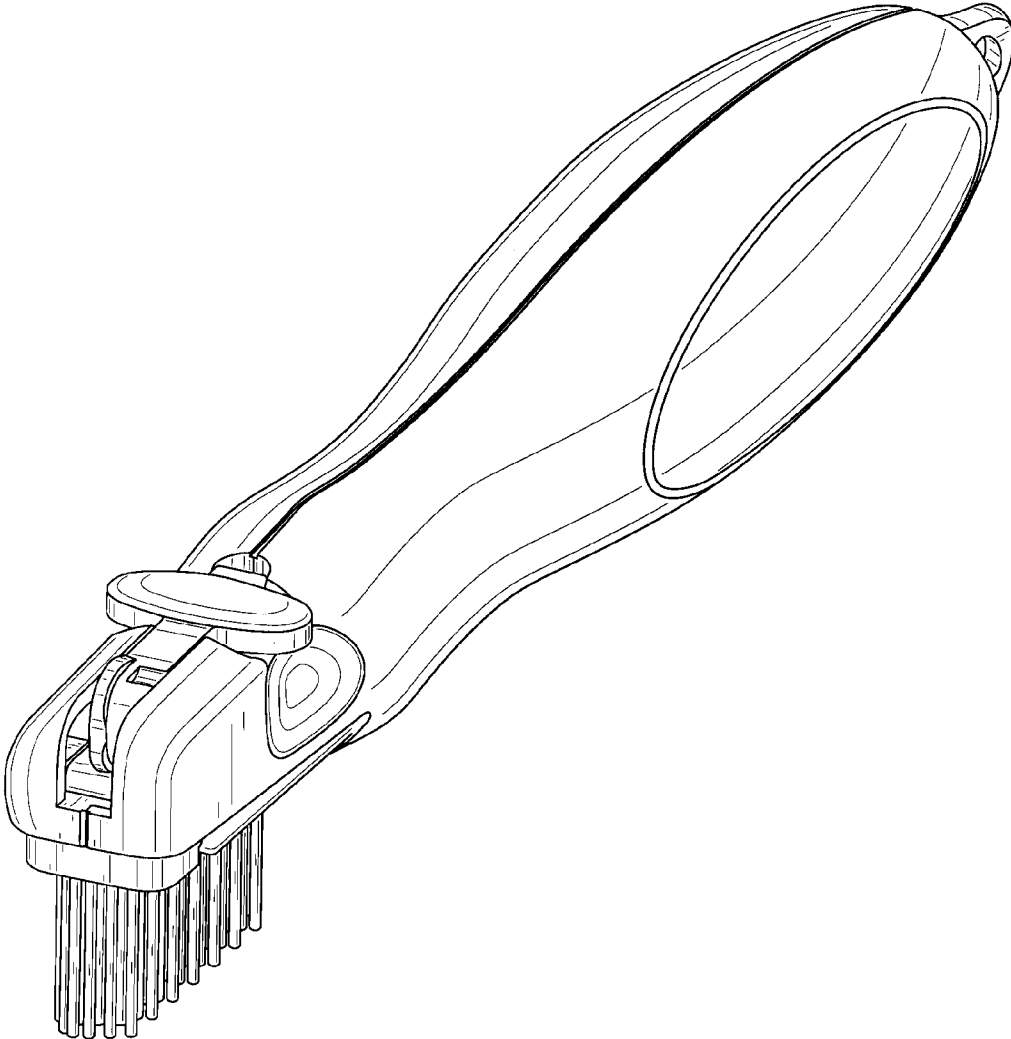

FIG. 1

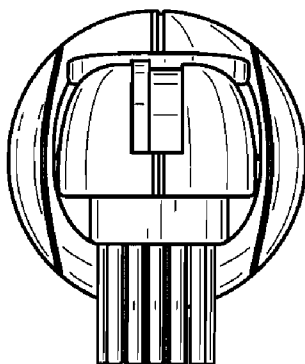

FIG. 2

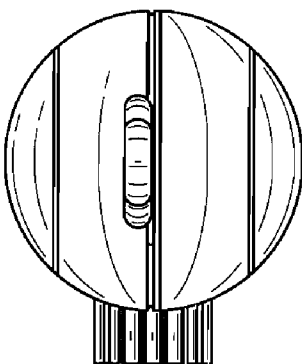

FIG. 3

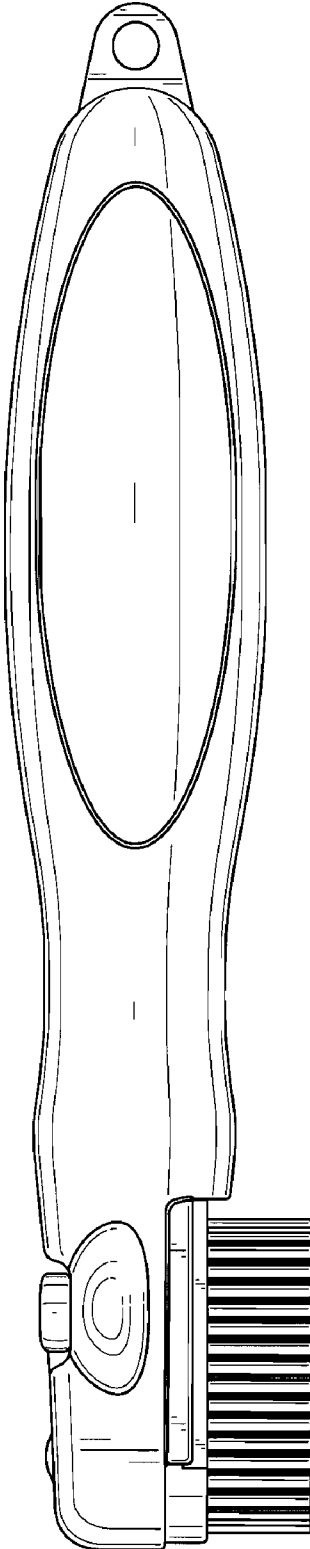

FIG. 4

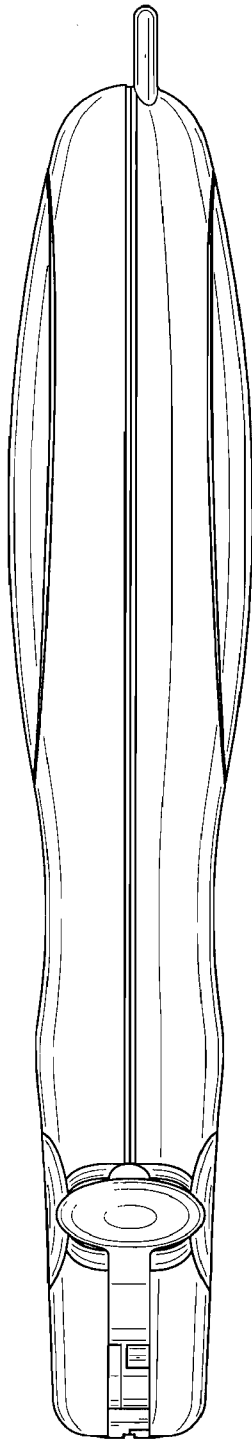

FIG. 5

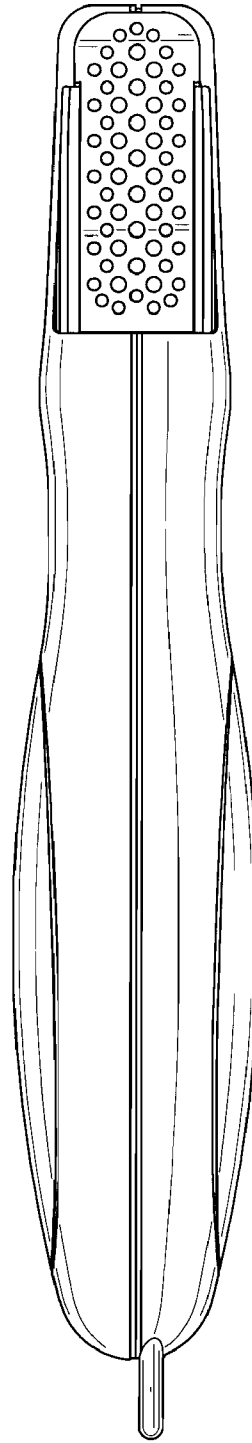

FIG. 6

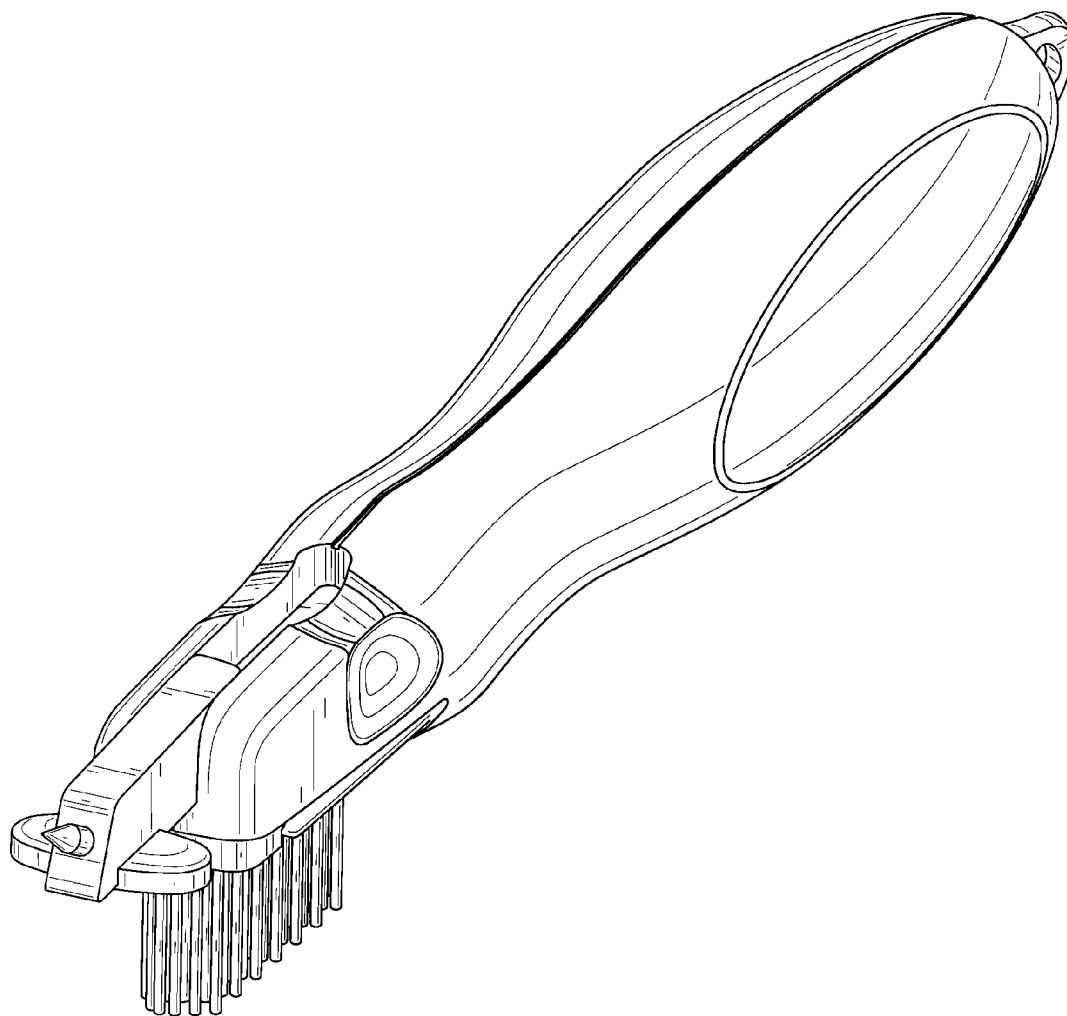

FIG. 7

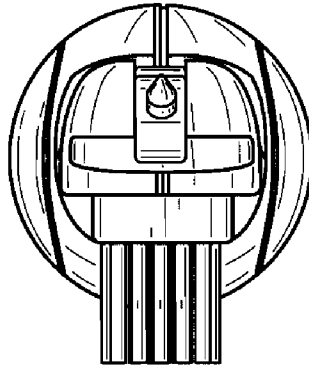

FIG. 8

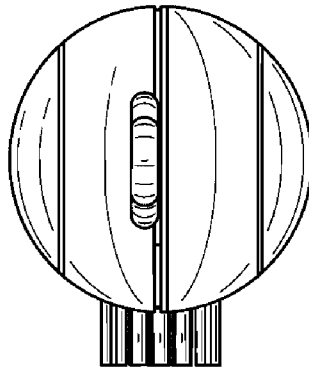

FIG. 9

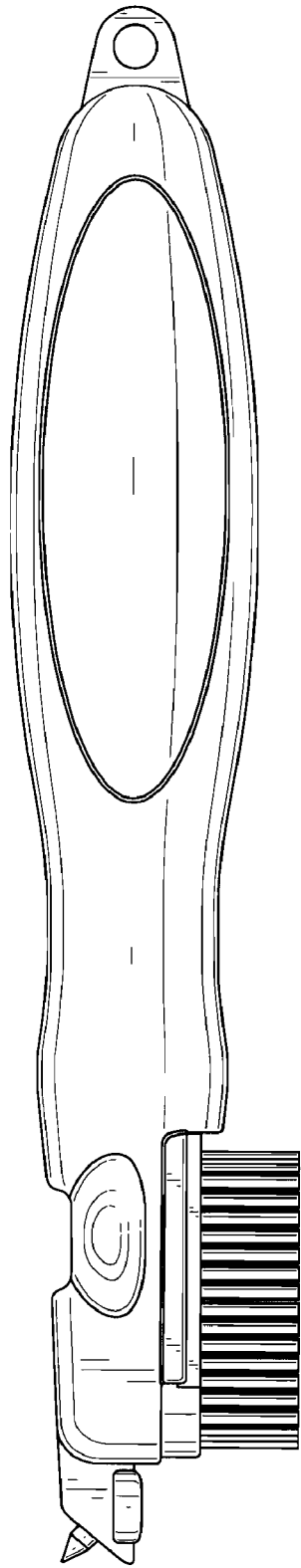

FIG. 10

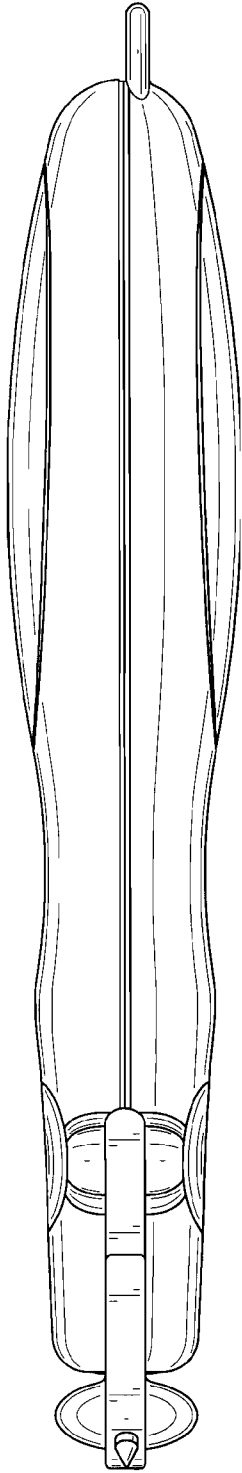

FIG. 11

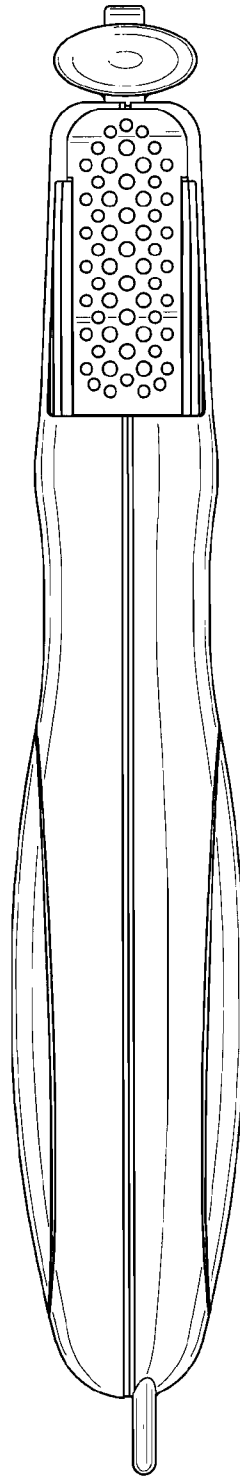

FIG. 12