



(12) **United States Design Patent**  
**Jang et al.**

(10) **Patent No.:** **US D781,007 S**  
(45) **Date of Patent:** **\*\* Mar. 7, 2017**

(54) **WASHING MACHINE**

FOREIGN PATENT DOCUMENTS

(71) Applicant: **SAMSUNG ELECTRONICS CO., LTD.**, Suwon-si (KR)

CN	301402813	8/2010
KR	300801729	6/2015
KR	300801732	6/2015

(72) Inventors: **Hayoung Jang**, Seoul (KR); **Kangdo Kim**, Seoul (KR)

OTHER PUBLICATIONS

Modern Design Museum, p. 1 [online]. [retrieved on Feb. 23, 2016]. Retrieved from the Internet:<URL:http://www.designmuseum.or.kr/sub/sub7\_1.asp?mode=view&idx=171L>.

(73) Assignee: **SAMSUNG ELECTRONICS CO., LTD.**, Gyeonggi-Do (KR)

(Continued)

(\*\*) Term: **15 Years**

*Primary Examiner* — Michael A. Pratt  
*Assistant Examiner* — Michelle E Wilson  
(74) *Attorney, Agent, or Firm* — Cantor Colburn, LLP

(21) Appl. No.: **29/555,619**

(57) **CLAIM**

(22) Filed: **Feb. 23, 2016**

The ornamental design for a washing machine, as shown and described.

(30) **Foreign Application Priority Data**

**DESCRIPTION**

Aug. 26, 2015 (KR) ..... 30-2015-0042957

FIG. 1 is a perspective view of a washing machine, showing our new design;

(51) **LOC (10) Cl.** ..... **15-05**

FIG. 2 is a front view thereof;

(52) **U.S. Cl.**  
USPC ..... **D32/6**

FIG. 3 is a rear view thereof;

(58) **Field of Classification Search**  
USPC ..... D32/1, 5-6, 8, 25, 28, 29, 67

FIG. 4 is a side view thereof;

(Continued)

FIG. 5 is another side view thereof;

(56) **References Cited**

U.S. PATENT DOCUMENTS

1,556,481	A *	10/1925	St Amour	.....	D06F 3/02	68/214
1,592,103	A *	7/1926	Gunuskey	.....	D06F 3/00	68/63

FIG. 6 is a top view thereof;

FIG. 7 is a bottom view thereof;

FIG. 8 is an enlarged view of the encircled portion 8 in FIG. 1, showing water supply nozzle thereof;

FIG. 9 is an enlarged view of the encircled portion 9 in FIG. 1, showing a left portion of a washboard thereof; and,

FIG. 10 is an exploded perspective view thereof.

The broken lines in the figures illustrating portions of the washing machine form no part of the claimed design.

The dash-dot-dot broken lines encircling enlargement portions of the washing machine form no part of the claimed design.

(Continued)

**1 Claim, 10 Drawing Sheets**

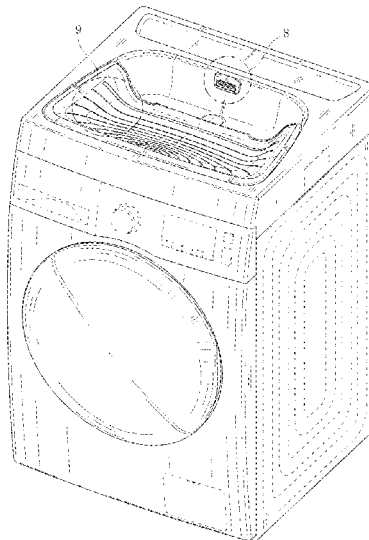

(58) **Field of Classification Search**  
 CPC .... D06F 33/02; D06F 39/02; D06F 2204/065;  
 D06F 25/00; D06F 35/006  
 See application file for complete search history.

(56) **References Cited**

U.S. PATENT DOCUMENTS

1,814,698 A \* 7/1931 Huber ..... D06F 1/04  
 68/233  
 2,129,079 A \* 9/1938 Adams ..... D06F 3/02  
 68/223  
 2,431,539 A \* 11/1947 Campanell ..... D06F 3/02  
 248/27.5  
 D153,319 S \* 4/1949 Rabinowitz ..... D32/67  
 2,504,819 A \* 4/1950 Flores ..... D06F 3/02  
 68/224  
 2,704,448 A \* 3/1955 Pettit ..... D06F 3/02  
 68/229  
 D189,496 S \* 12/1960 Kinyon ..... D32/67

D193,208 S \* 7/1962 Graham ..... D32/67  
 3,664,160 A \* 5/1972 Muniz ..... D06F 3/00  
 68/224  
 D235,001 S \* 4/1975 Sunday ..... D32/67  
 D235,002 S \* 4/1975 Sunday ..... D32/67  
 D237,448 S \* 11/1975 Sunday ..... D32/67  
 D254,230 S \* 2/1980 Sanger ..... D32/67  
 D259,993 S \* 7/1981 Kunze ..... D32/67  
 4,756,439 A \* 7/1988 Perock ..... D06F 1/04  
 15/264  
 6,169,237 B1 \* 1/2001 Sanders ..... G10D 13/06  
 84/102  
 D549,915 S \* 8/2007 Pastrana-Rangel ..... D32/67

OTHER PUBLICATIONS

Samsung CE Korea. pp. 1-26 [online]. [retrieved on Feb. 23, 2016].  
 Retrieved from the Internet: <URL: <http://samsungcekorea.com/m/post/2607>>.

\* cited by examiner

FIG. 1

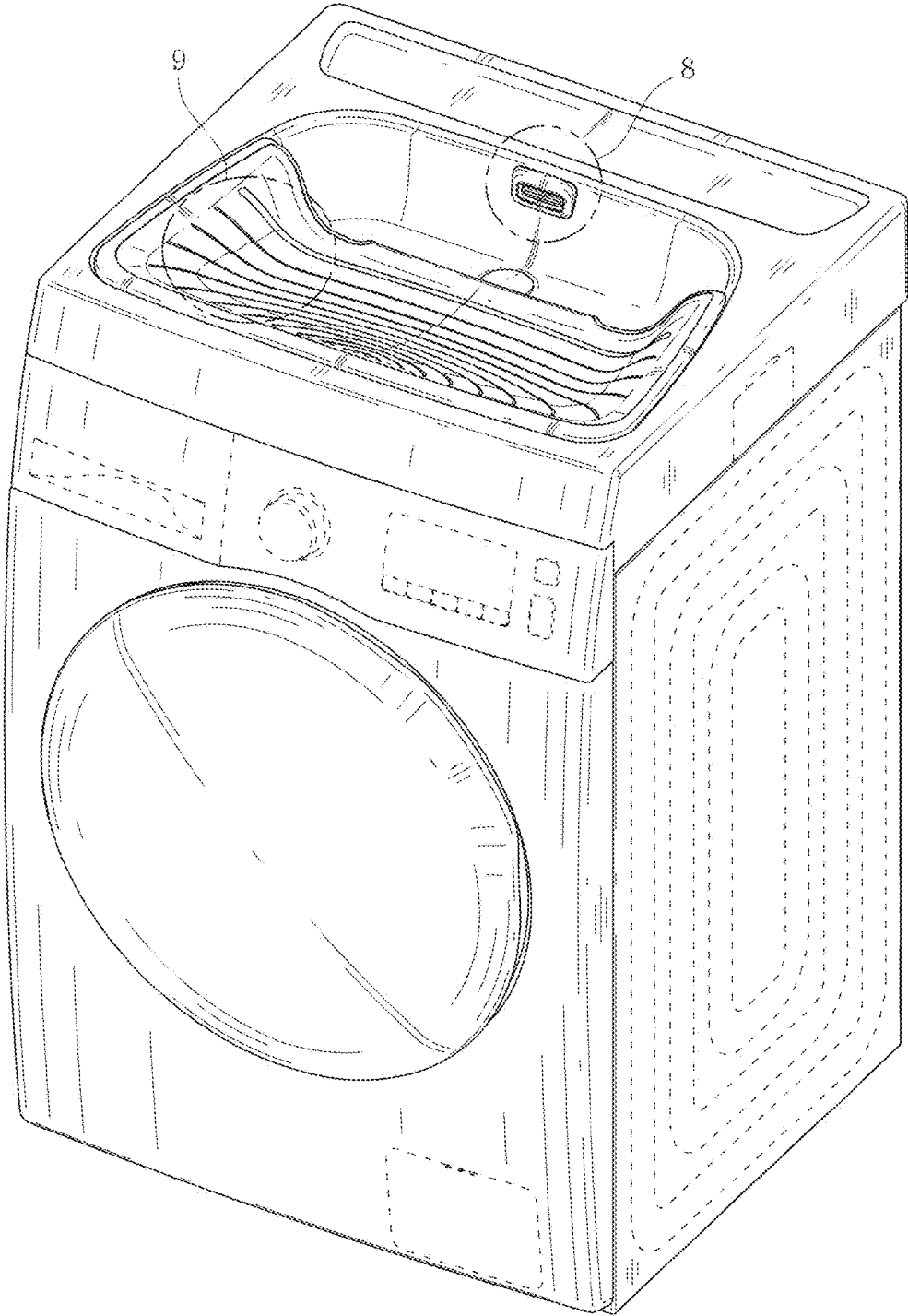

FIG. 2

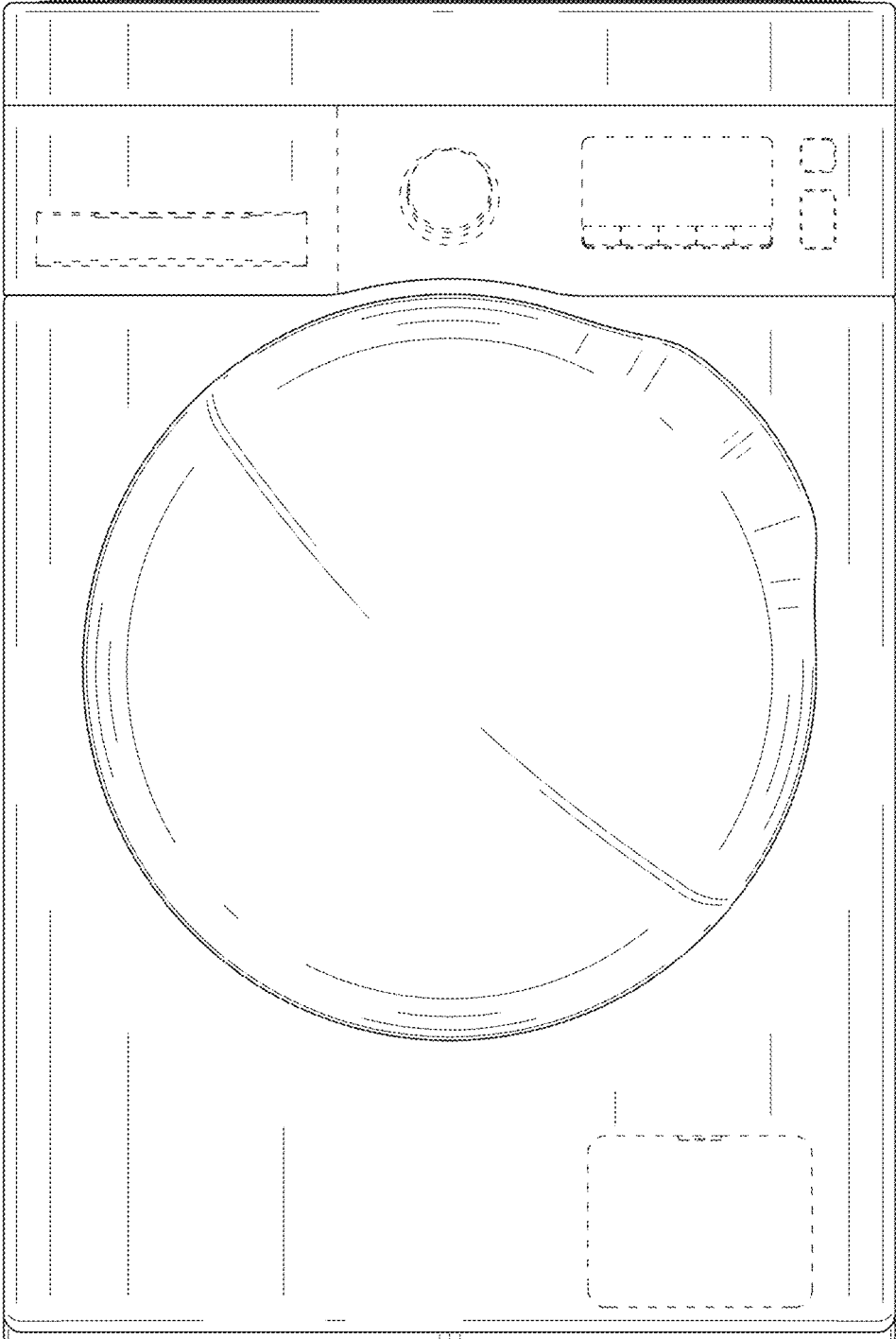

FIG. 3

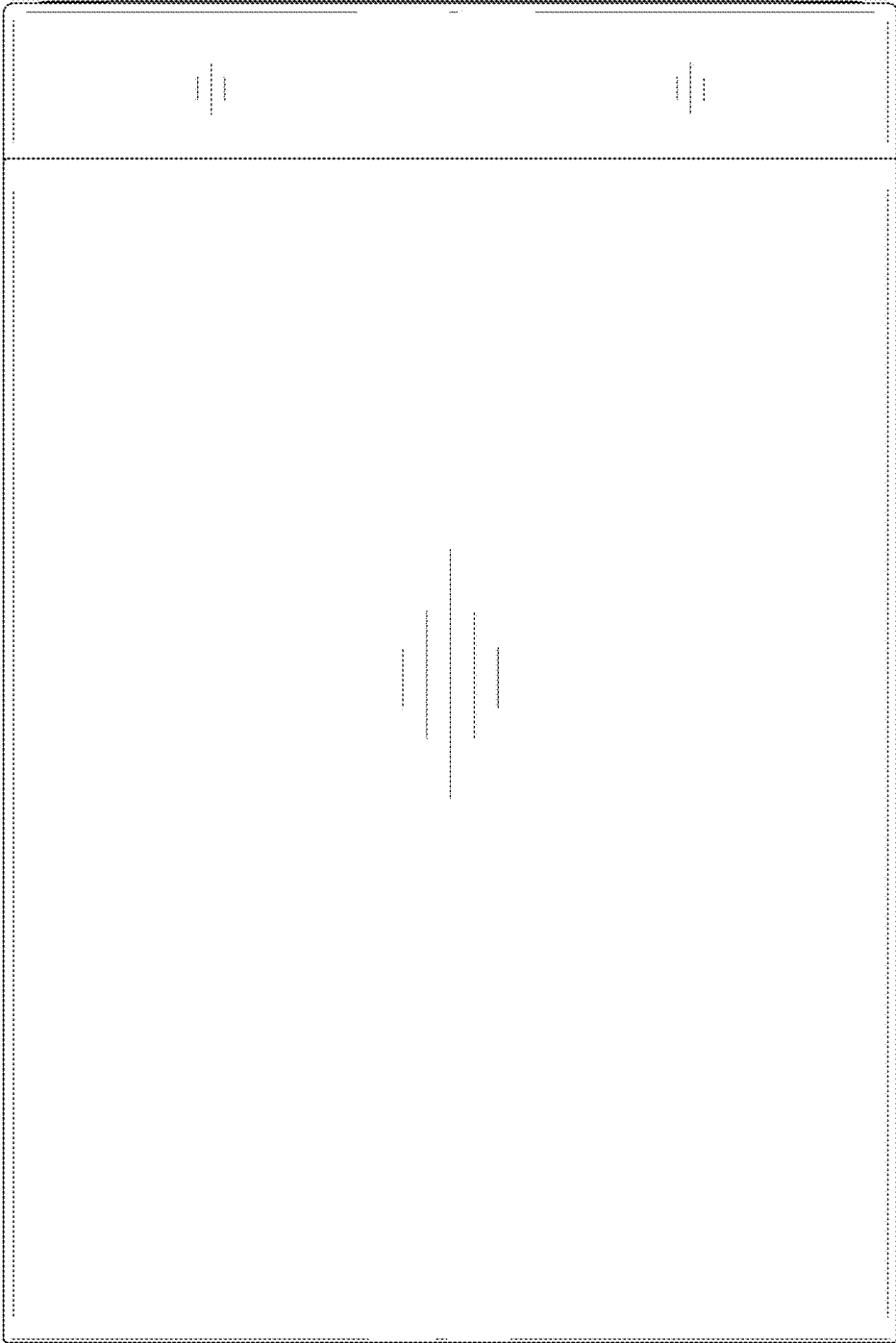

FIG. 4

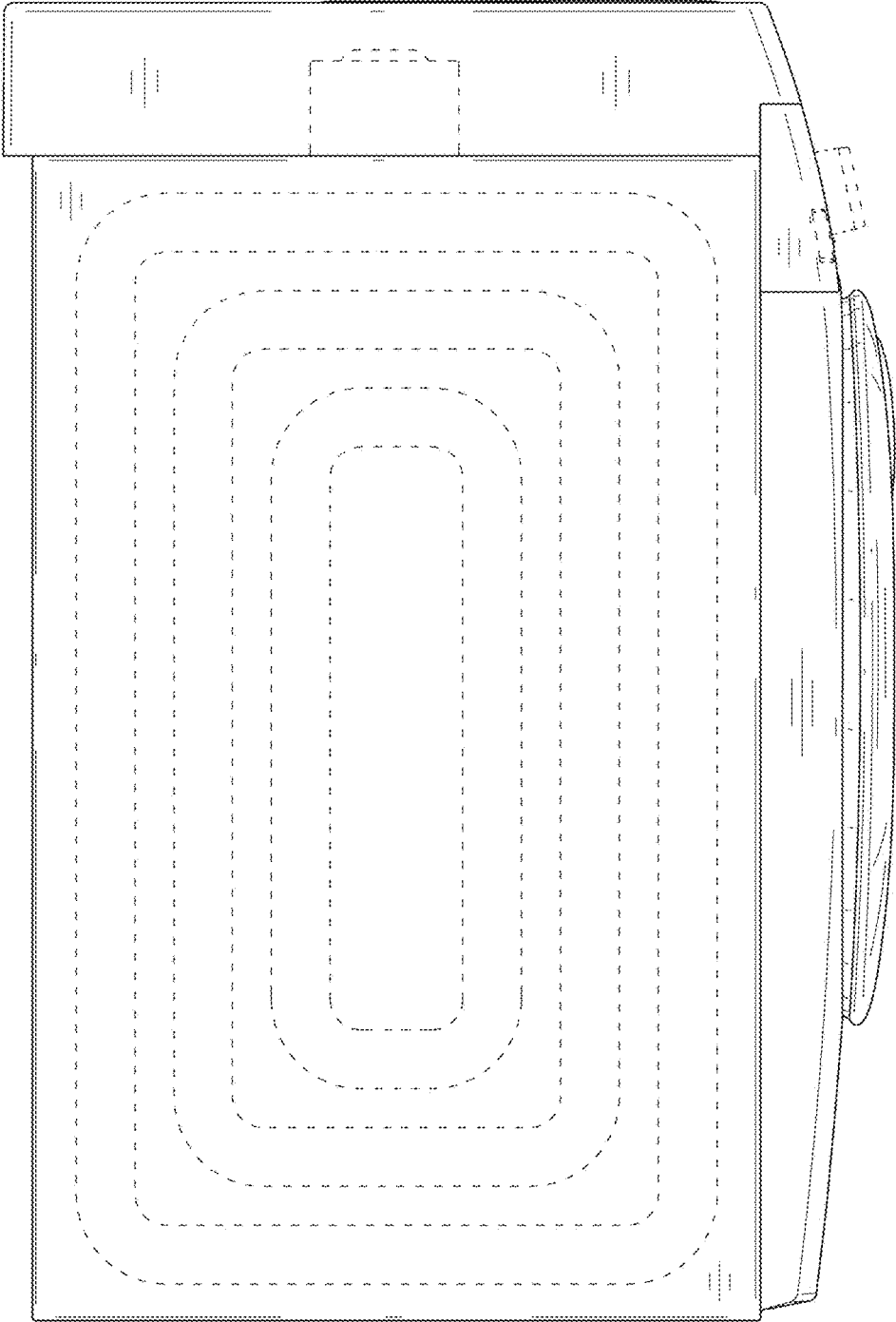

FIG. 5

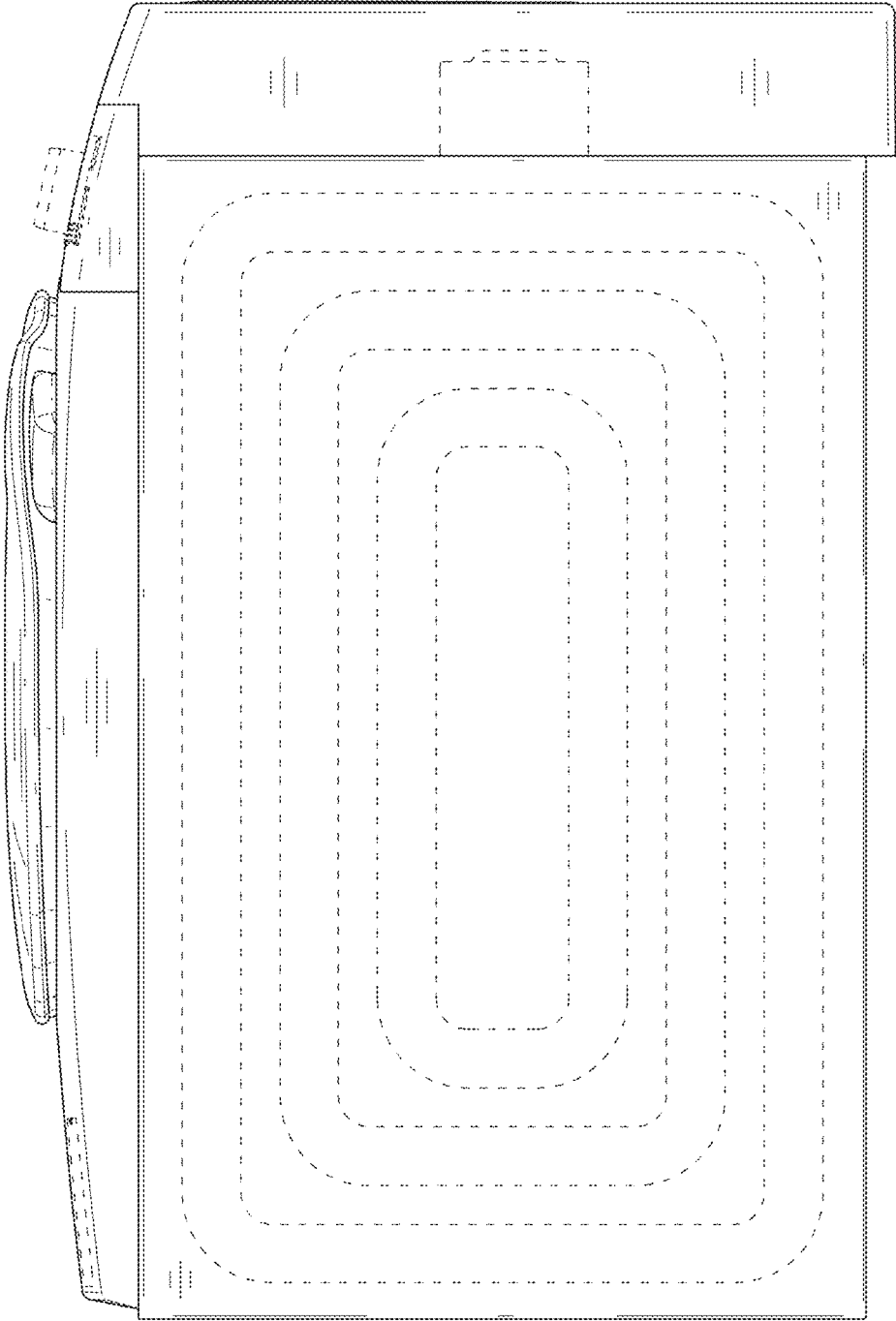

FIG. 6

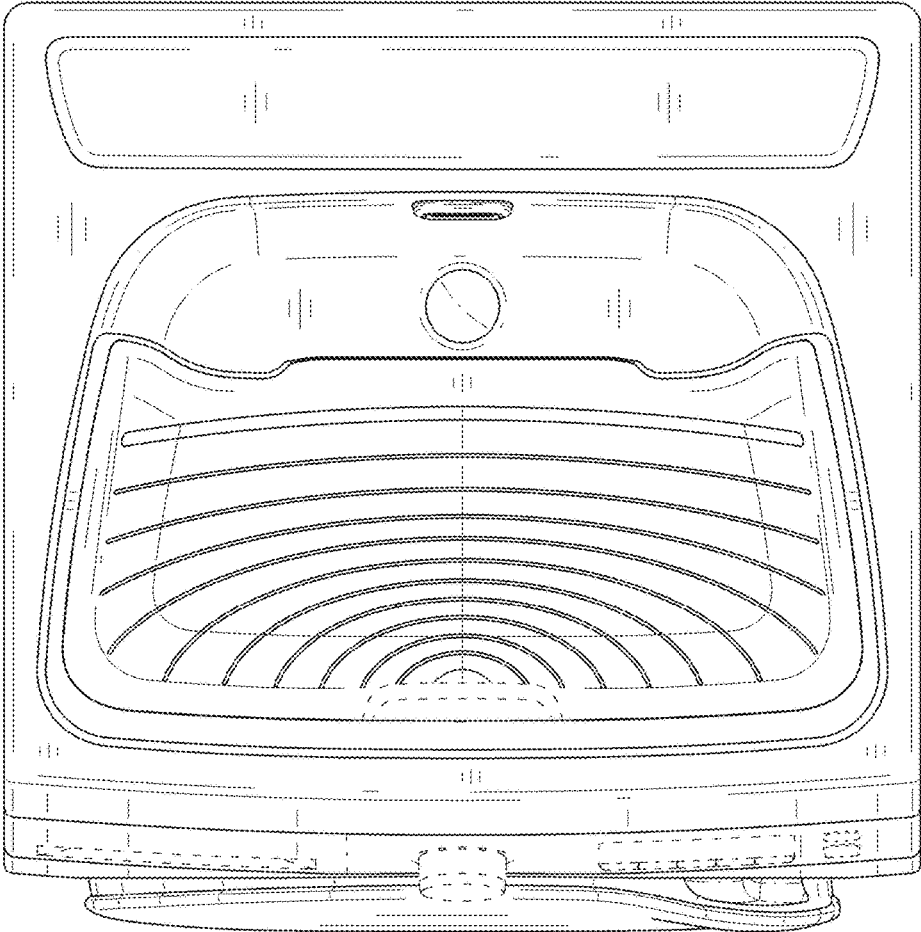

FIG. 7

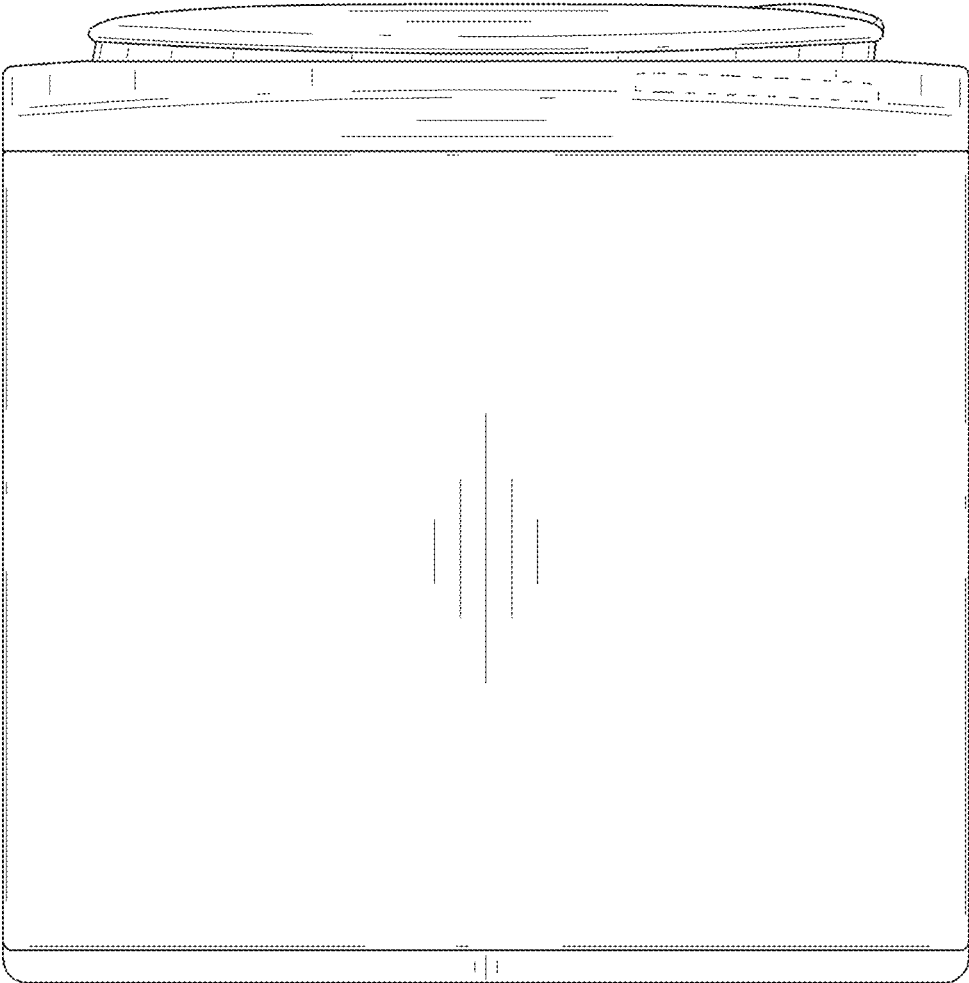

FIG. 8

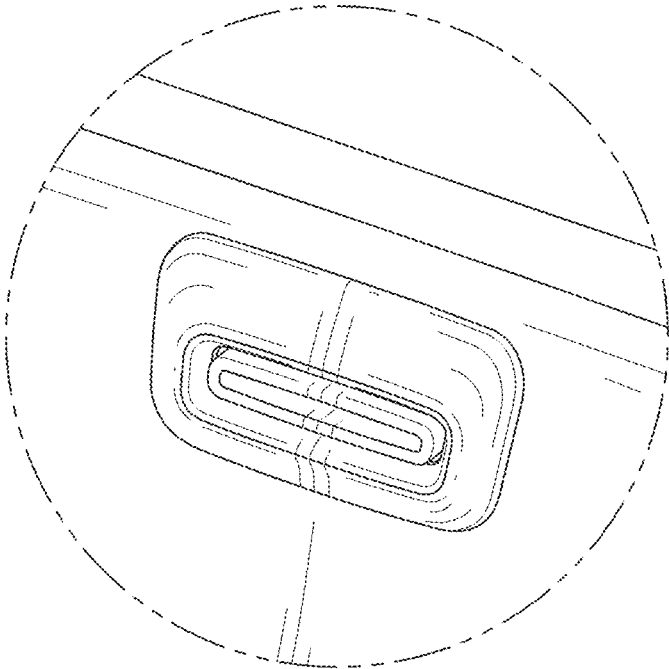

FIG. 9

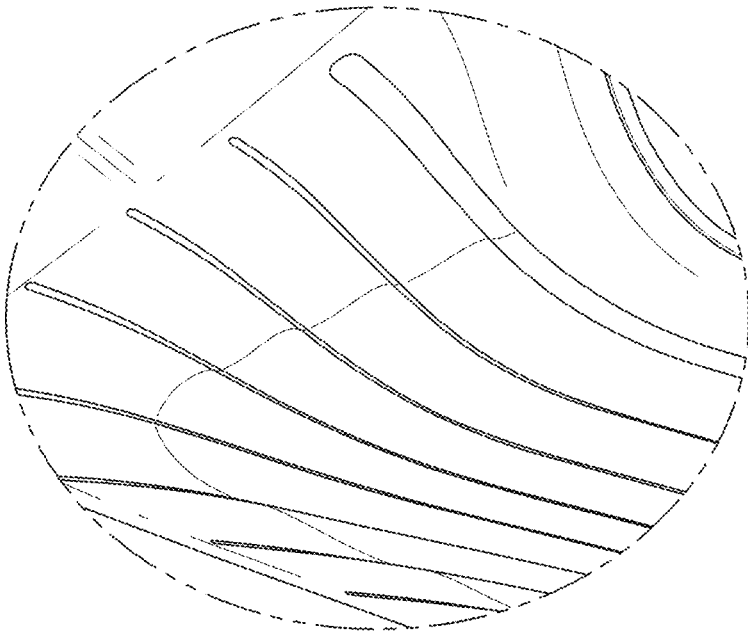

FIG. 10

