



US00D613637S

(12) **United States Design Patent**  
**Grassi Damiani**

(10) **Patent No.:** **US D613,637 S**

(45) **Date of Patent:** **\*\* Apr. 13, 2010**

- (54) **BRACELET JEWELRY ARTICLE**
- (75) Inventor: **Giorgio Andrea Grassi Damiani**,  
Valenza (IT)
- (73) Assignee: **Casa Damiani S.p.A.**, Valenza (IT)
- (\*\*) Term: **14 Years**
- (21) Appl. No.: **29/318,907**
- (22) Filed: **May 30, 2008**

**Related U.S. Application Data**

- (62) Division of application No. 29/296,474, filed on Oct. 22, 2007, now Pat. No. Des. 586,685.

**Foreign Application Priority Data**

Apr. 20, 2007 (IT) ..... MI2007O0109

- (51) **LOC (9) Cl.** ..... **11-01**
- (52) **U.S. Cl.** ..... **D11/13**
- (58) **Field of Classification Search** ..... D11/1-25,  
D11/93, 94; 63/3, 3.1, 3.2, 4, 5.1, 7, 10,  
63/11, 15, 15.7, 18, 21, 35, 37, 38; D10/30-39  
See application file for complete search history.

**References Cited**

**U.S. PATENT DOCUMENTS**

310,953 A *	1/1885	Mersereau	362/326
757,772 A *	4/1904	Rodenberg	59/79.1
858,450 A *	7/1907	Greenbaum	63/15.2
951,926 A *	3/1910	White	63/33
1,035,909 A *	8/1912	Robbins	63/28
1,192,092 A *	7/1916	Morse	63/28
1,411,995 A *	4/1922	Dull	474/233
1,469,450 A *	10/1923	Stone	132/148
1,534,442 A *	4/1925	Donahue	63/28
1,594,885 A *	8/1926	Kaplan	63/15
1,596,726 A *	8/1926	Ford	63/20
1,655,763 A *	1/1928	Fulford	59/90
2,080,317 A *	5/1937	Jaeckel	63/28
D108,123 S *	1/1938	Granat	D11/91
2,172,613 A *	9/1939	Hirsh	63/26

2,355,944 A *	8/1944	Beggs	59/83
D147,004 S *	7/1947	Chernow	D11/93
2,681,545 A *	6/1954	Hall	59/80
3,601,977 A *	8/1971	Kunzmann	59/79.1
D303,941 S *	10/1989	Perrin	D11/21
5,682,768 A *	11/1997	Nissenbaum	63/15.1
D388,728 S *	1/1998	Bulgari	D11/6
D404,677 S *	1/1999	Johnson	D11/5
D410,406 S *	6/1999	Iwanoto et al.	D11/3
D415,976 S *	11/1999	Be	D11/4
D446,146 S *	8/2001	Cevallos	D11/3
D470,790 S *	2/2003	Schmidt	D11/11
6,557,376 B2 *	5/2003	Pratt	63/3
D480,323 S *	10/2003	Levi	D11/91
D521,891 S *	5/2006	Stromko	D11/15
7,104,041 B1 *	9/2006	Sherman	59/35.1
D549,612 S *	8/2007	Kothari	D11/91
7,266,514 B2 *	9/2007	Herbert et al.	705/26
D553,542 S *	10/2007	Kothari	D11/91
D557,165 S *	12/2007	Basha	D11/16
D580,810 S *	11/2008	Reilly	D11/7
D580,811 S *	11/2008	Bulgari	D11/16
7,478,543 B2 *	1/2009	Butler	63/28
D586,685 S *	2/2009	Grassi Damiani	D11/16
2004/0194501 A1 *	10/2004	Gruosi-Scheufele	63/1.14
2007/0256452 A1 *	11/2007	Aghjayan	63/26
2008/0148772 A1 *	6/2008	Bauman et al.	63/12
2008/0168800 A1 *	7/2008	Nisguretsky	63/27

**FOREIGN PATENT DOCUMENTS**

JP 01085603 A \* 3/1989

\* cited by examiner

*Primary Examiner*—T. Chase Nelson  
*Assistant Examiner*—Michael A Pratt  
(74) *Attorney, Agent, or Firm*—Cozen O'Connor

(57) **CLAIM**

I claim the ornamental design for a bracelet jewelry article, as shown and described.

**DESCRIPTION**

FIG. 1 illustrates a top perspective view of the bracelet jewelry article showing a first embodiment of my new design in open position;

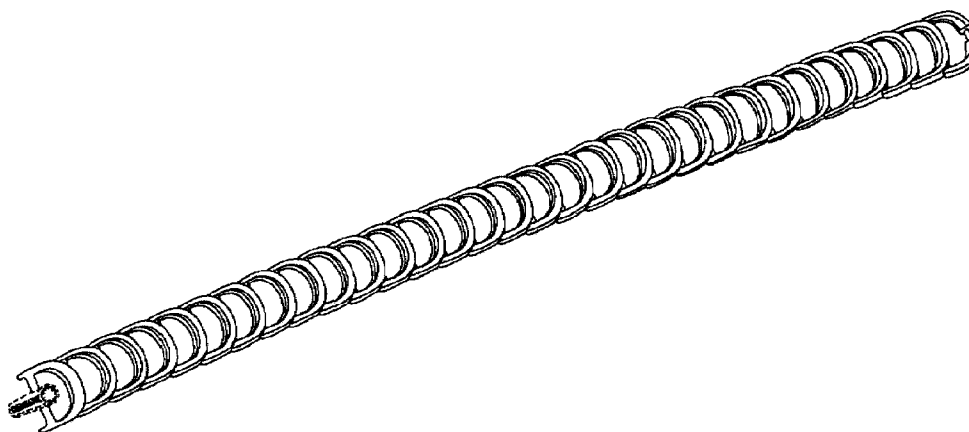

FIG. 2 illustrates a partial rear perspective view of the bracelet jewelry article showing the first embodiment of my new design in closed position;

FIG. 3 illustrates a bottom perspective view of the bracelet jewelry article showing the first embodiment of my new design in open position;

FIG. 4 illustrates a partial lateral perspective view of the bracelet jewelry article showing the first embodiment of my new design in open position;

FIG. 5 illustrates a partial lateral perspective view of the bracelet jewelry article showing the first embodiment of my new design in open position;

FIG. 6 illustrates a partial perspective view from the top of the bracelet jewelry article showing the first embodiment of my new design in open position;

FIG. 7 illustrates a partial perspective view from the bottom of the bracelet jewelry article showing the first embodiment of my new design in open position;

FIG. 8 illustrates a top perspective view of the bracelet jewelry article showing a second embodiment of my new design in open position;

FIG. 9 illustrates a partial rear perspective view of the bracelet jewelry article showing the second embodiment of my new design in closed position;

FIG. 10 illustrates a bottom perspective view of the bracelet jewelry article showing the second embodiment of my new design in open position;

FIG. 11 illustrates a partial lateral perspective view of the bracelet jewelry article showing the second embodiment of my new design in open position;

FIG. 12 illustrates a partial lateral perspective view of the bracelet jewelry article showing the second embodiment of my new design in open position;

FIG. 13 illustrates a partial perspective view from the top of the bracelet jewelry article showing the second embodiment of my new design in open position; and,

FIG. 14 illustrates a partial perspective view from the bottom of the bracelet jewelry article showing the second embodiment of my new design in open position.

The broken lines showing of the gemstones in FIGS. 8 and 12 and the clasp in FIGS. 2 through 4, 6 and 8 through 13 is included for the purpose of illustrating environment and forms no part of the claimed design.

The name Damiani displayed on the bracelet jewelry article is a trademark owned by Damiani International B.V.

**1 Claim, 5 Drawing Sheets**

FIGURE 1

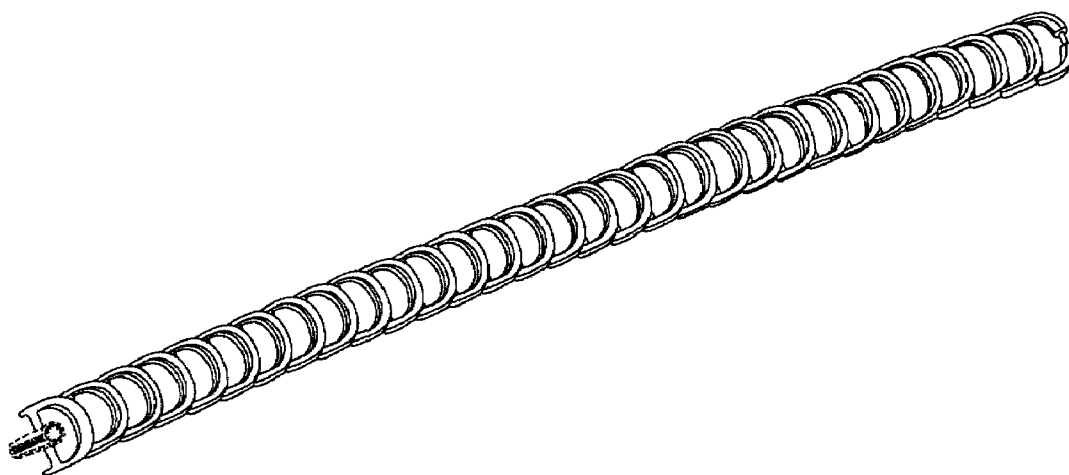

FIGURE 2

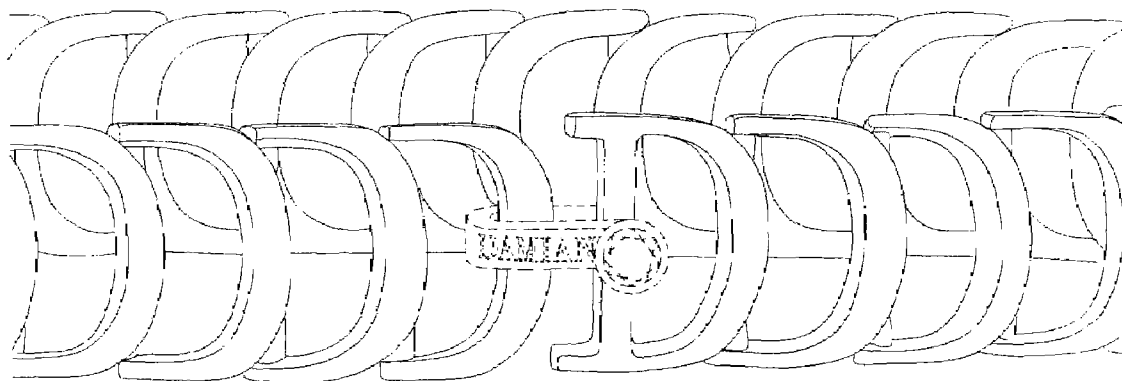

FIGURE 3

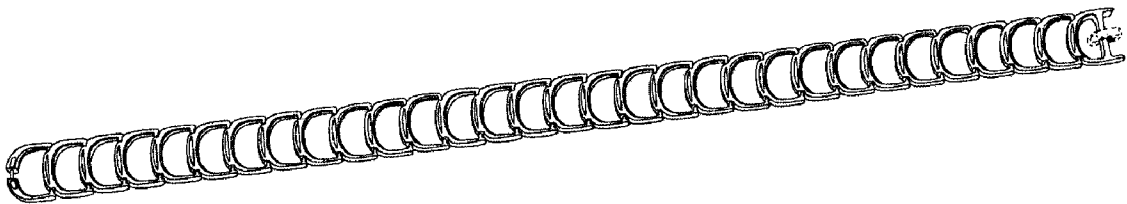

FIGURE 4

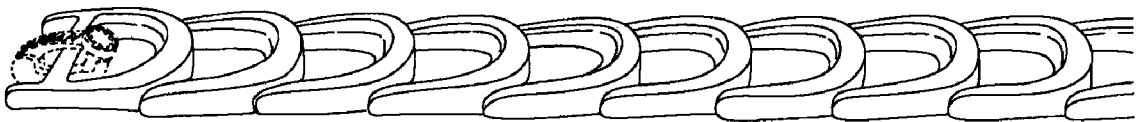

FIGURE 5

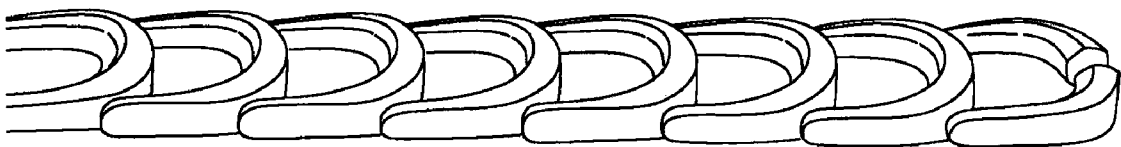

FIGURE 6

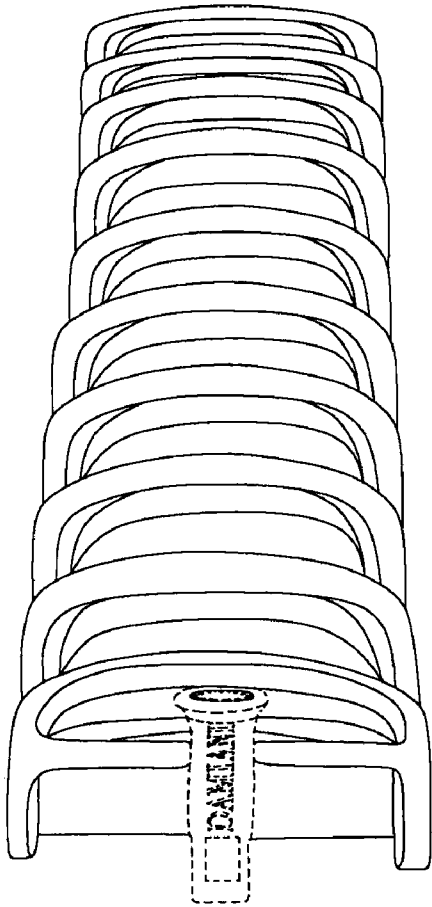
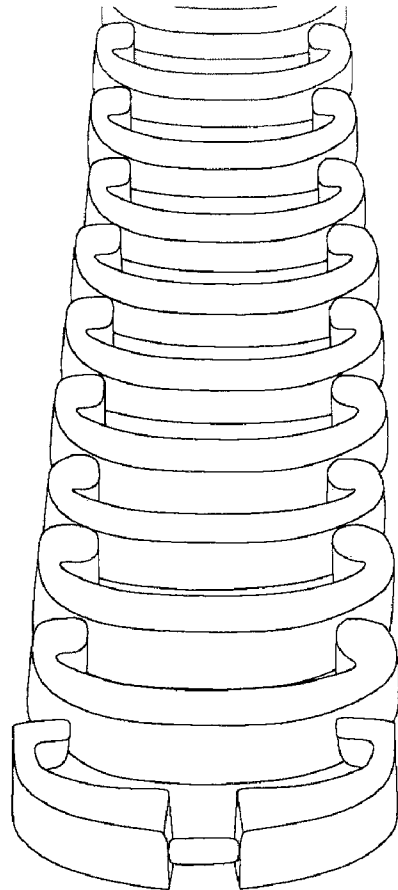
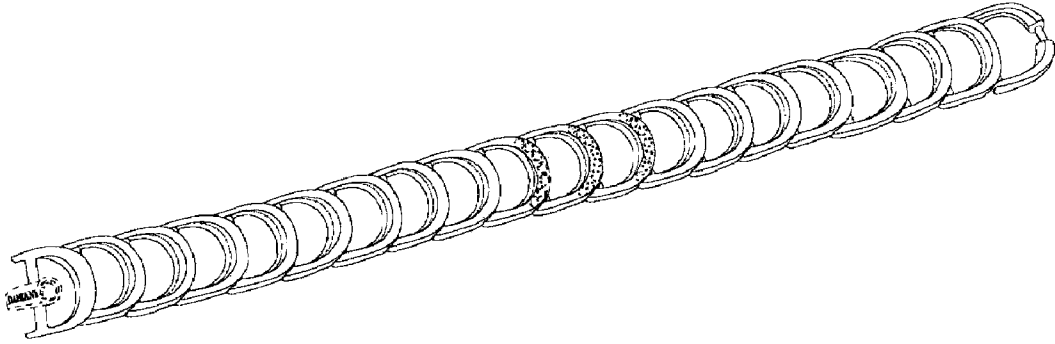

FIGURE 7



**FIGURE 8**



**FIGURE 9**

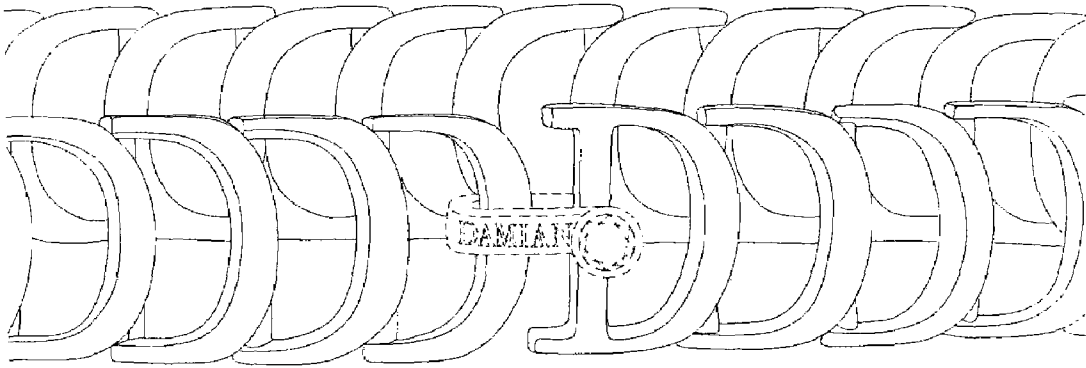

**FIGURE 10**

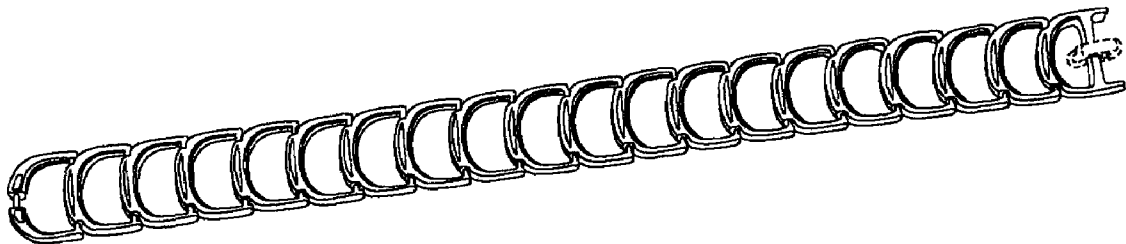

FIGURE 11

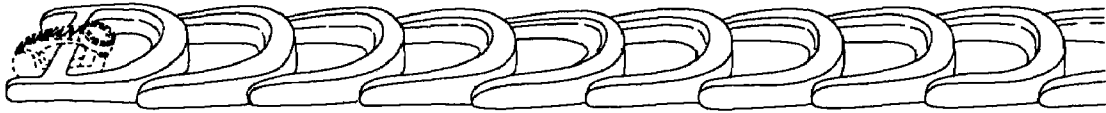

FIGURE 12

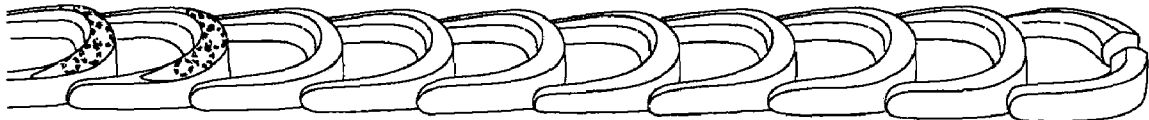

FIGURE 13

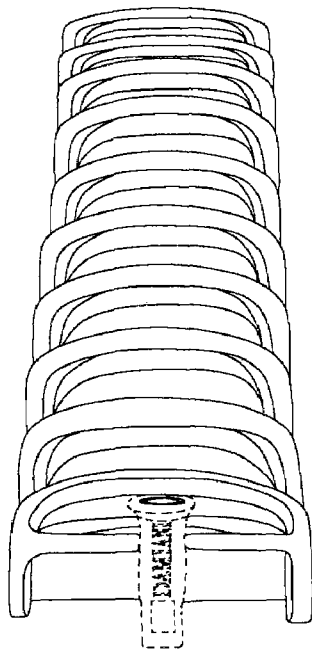

FIGURE 14

