



US00D719006S

(12) **United States Design Patent**
Steiner et al.

(10) **Patent No.:** **US D719,006 S**

(45) **Date of Patent:** **** Dec. 9, 2014**

(54) **TOOL**

(71) Applicant: **Rostra Tool Company**, Branford, CT (US)

(72) Inventors: **Richard A. Steiner**, East Haddam, CT (US); **Joseph Krzyzanski**, New Haven, CT (US)

(73) Assignee: **Rostra Tool Company**, Branford, CT (US)

(**) Term: **14 Years**

(21) Appl. No.: **29/467,938**

(22) Filed: **Sep. 25, 2013**

(51) **LOC (10) Cl.** **08-05**

(52) **U.S. Cl.**

USPC **D8/105; D8/56**

(58) **Field of Classification Search**

USPC D8/4, 5, 14, 16, 18, 19, 20–29, 33, 34, D8/38–43, 51–52, 55–57, 75, 77, 81–87, D8/98–99, 102, 104–107, 354, 356, 358, D8/360.1; 7/151–166, 107, 108, 119, 128, 7/143–147; 30/151, 359, 366, 299, 2, 30/152, 287, 294, 314, 317, 329–331, 337, 30/339, 353; D3/24, 25, 207–208, 210, D3/228; D10/46.2, 62; 362/119; 206/38, 206/232, 234; 81/3.09, 437, 440, 19, 20, 81/26; D7/368, 665, 669; D27/163, 167, D27/172, 181, 194, 195; 15/22.2, 104.03, 15/104.001, 104.04, 104.05, 104.06, 15/104.066, 105, 111; D4/116, 121, 199, D4/138; 280/507

See application file for complete search history.

(56) **References Cited**

U.S. PATENT DOCUMENTS

2,753,742 A * 7/1956 Buchanan 72/402
2,774,269 A * 12/1956 Klingler et al. 72/472

(Continued)

Primary Examiner — Susan Bennett Hattan

Assistant Examiner — Janice Hallmark

(74) *Attorney, Agent, or Firm* — Cantor Colburn LLP

(57) **CLAIM**

We claim, the ornamental design for a tool, as shown and described.

DESCRIPTION

FIG. 1 is a perspective view of an embodiment of the invention;

FIG. 2 is a reverse perspective view of the embodiment of FIG. 1;

FIG. 3 is a top view of the embodiment of FIG. 1;

FIG. 4 is a bottom view of the embodiment of FIG. 1;

FIG. 5 is a first side view of the embodiment of FIG. 1;

FIG. 6 is a second side view of the embodiment of FIG. 1;

FIG. 7 is a first end view of the embodiment of FIG. 1;

FIG. 8 is a second end view of the embodiment of FIG. 1;

FIG. 9 is a perspective view of another embodiment of the invention;

FIG. 10 is a reverse perspective view of the embodiment of FIG. 9;

FIG. 11 is a top view of the embodiment of FIG. 9;

FIG. 12 is a bottom view of the embodiment of FIG. 9;

FIG. 13 is a first side view of the embodiment of FIG. 9;

FIG. 14 is a second side view of the embodiment of FIG. 9;

FIG. 15 is a first end view of the embodiment of FIG. 9; and,

FIG. 16 is a second end view of the embodiment of FIG. 9.

The broken lines in the drawings illustrate portions of the tool which form no part of the claimed design.

1 Claim, 12 Drawing Sheets

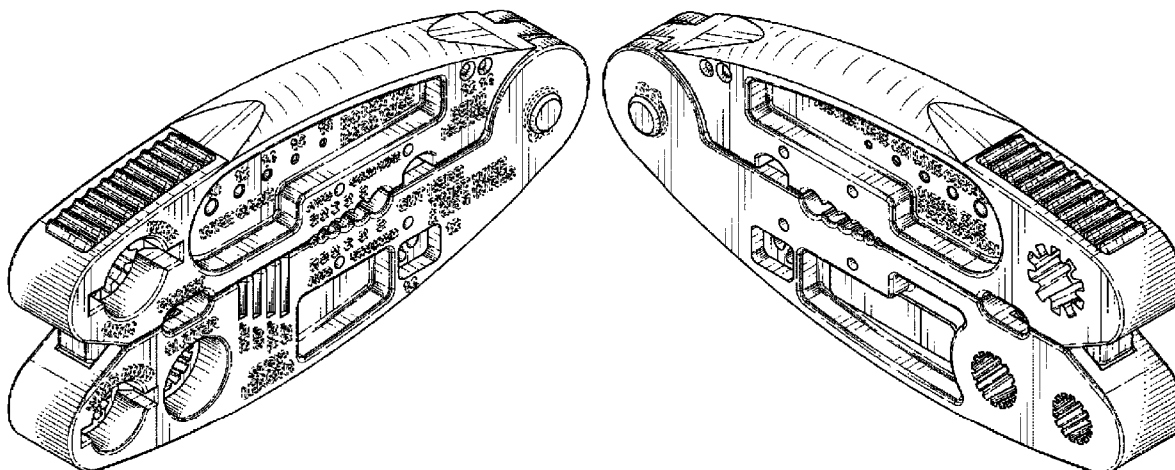

(56)

References Cited

U.S. PATENT DOCUMENTS

2,787,925	A *	4/1957	Buchanan et al.	72/402	7,171,712	B2 *	2/2007	Konen	7/107
3,525,107	A *	8/1970	Hays	7/107	D596,911	S *	7/2009	Carpenter et al.	D8/55
D237,453	S *	11/1975	Perrino	D8/56	D603,240	S *	11/2009	Kunzendorf	D8/105
4,677,702	A *	7/1987	Cairns	7/107	D623,039	S *	9/2010	Seeds et al.	D8/107
D336,025	S *	6/1993	Steiner	D8/52	D630,080	S *	1/2011	Seeds et al.	D8/105
D422,861	S *	4/2000	Hollinger	D8/41	D646,537	S *	10/2011	Kidd	D8/56
D485,146	S *	1/2004	Rivera	D8/52	8,087,115	B2 *	1/2012	Barber et al.	7/167
					D685,239	S *	7/2013	Steiner et al.	D8/56
					2013/0111763	A1 *	5/2013	Steiner et al.	30/91.2
					2014/0165353	A1 *	6/2014	Steiner et al.	29/243.5

* cited by examiner

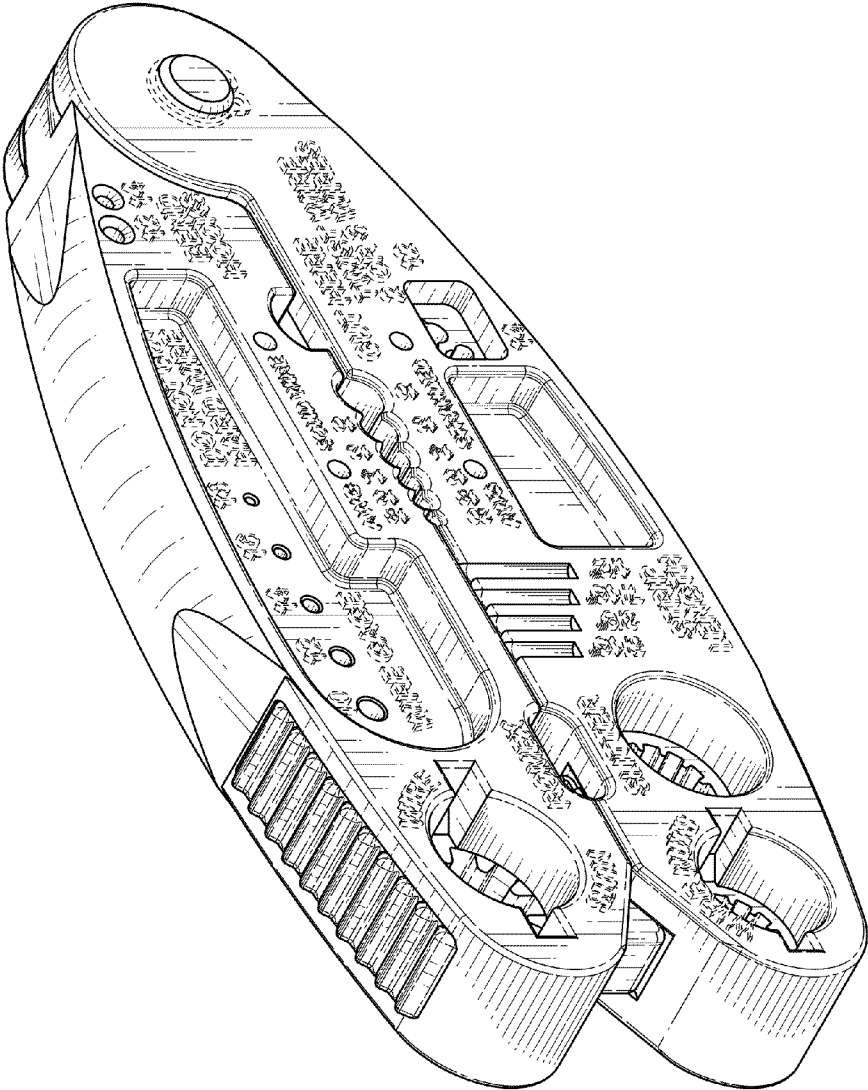

FIG. 1

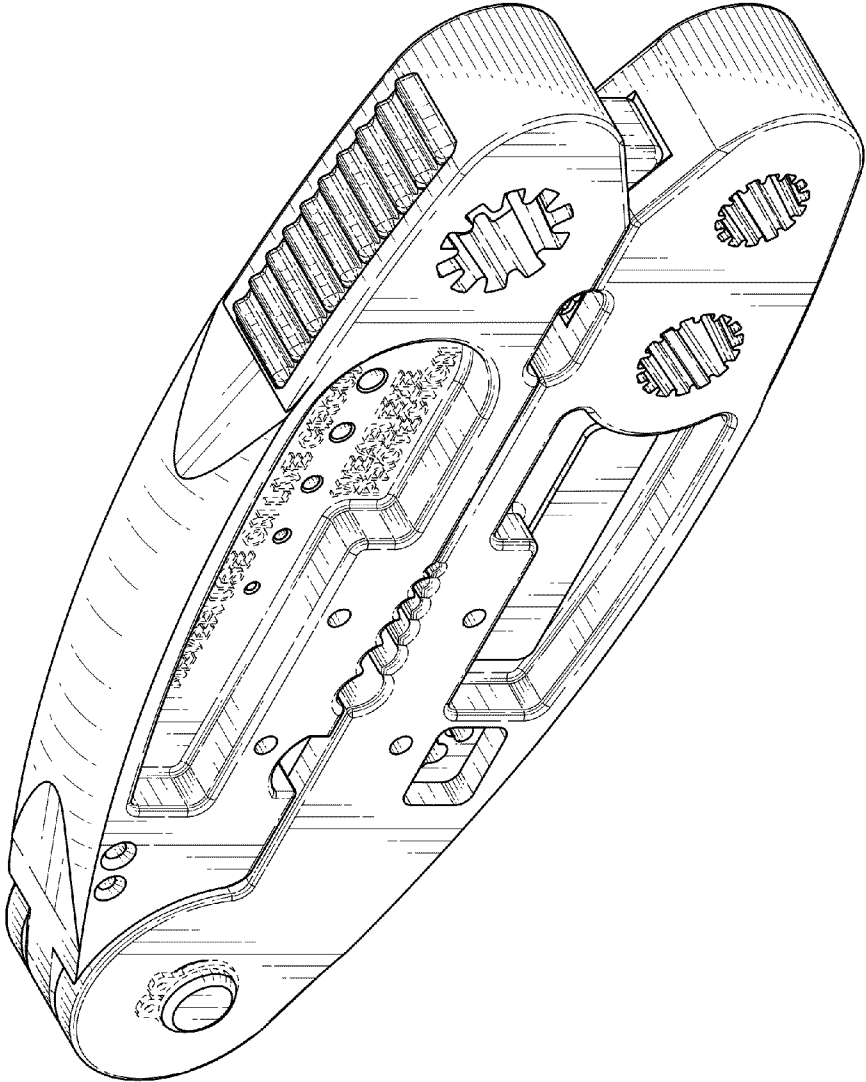

FIG. 2

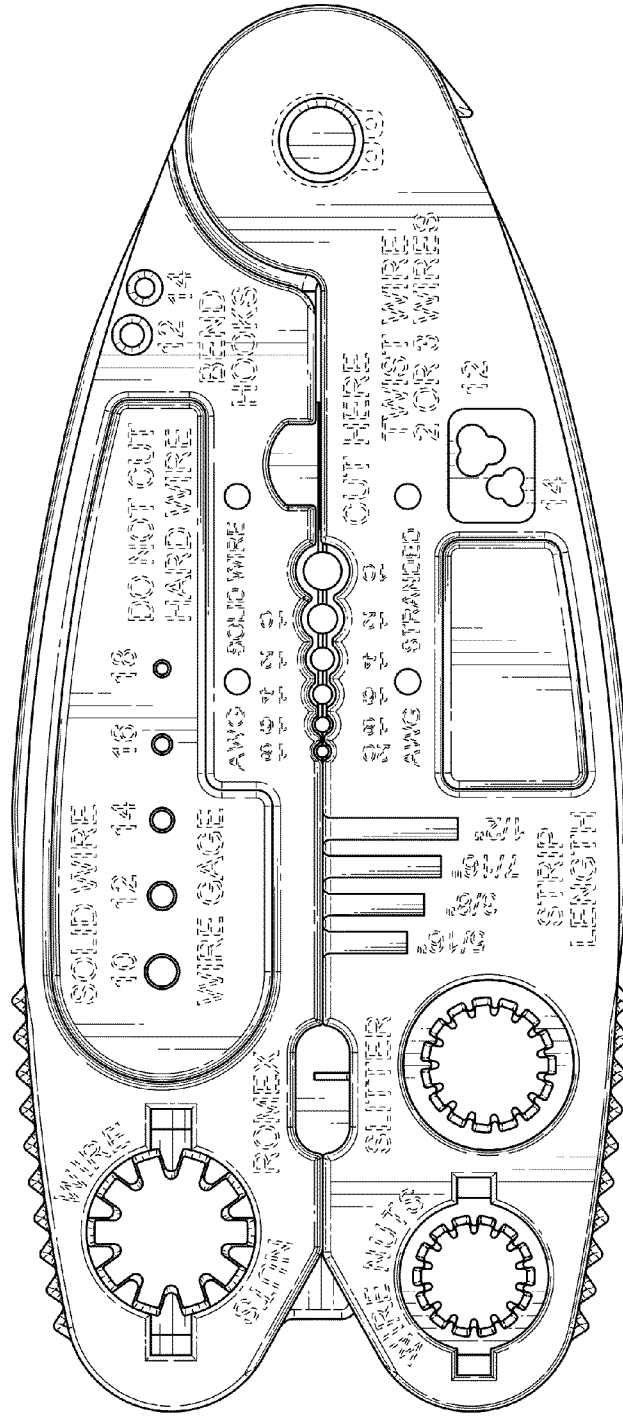

FIG. 3

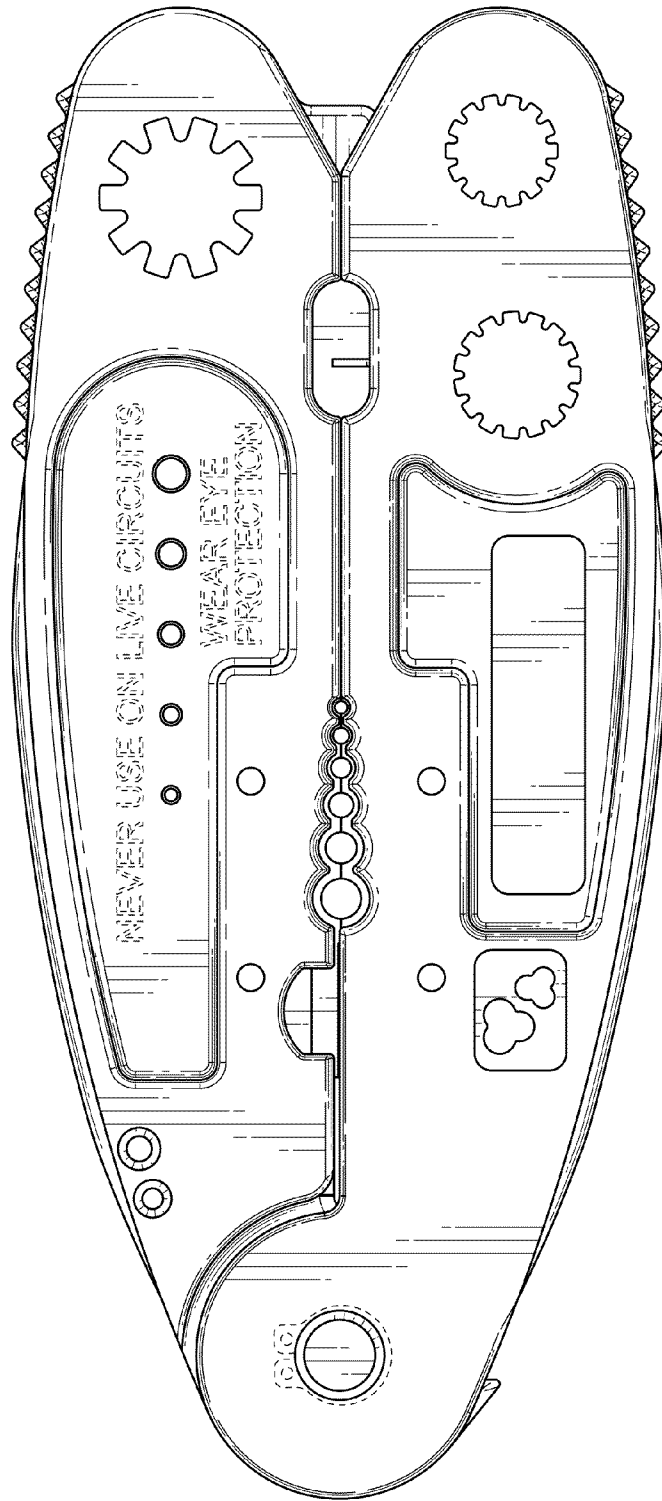

FIG. 4

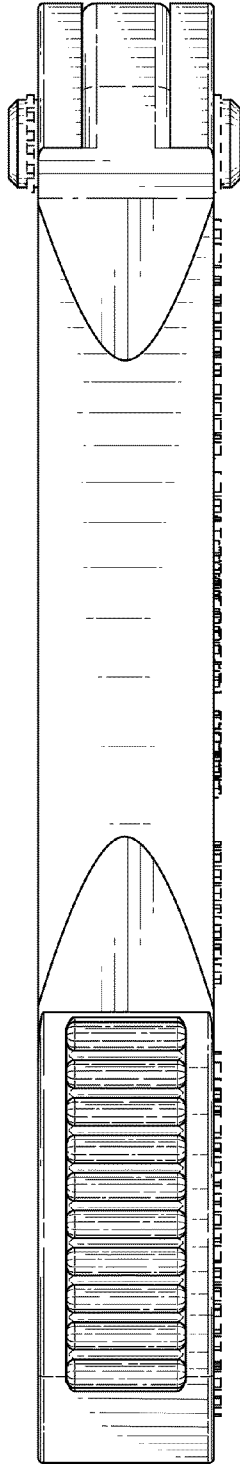

FIG. 5

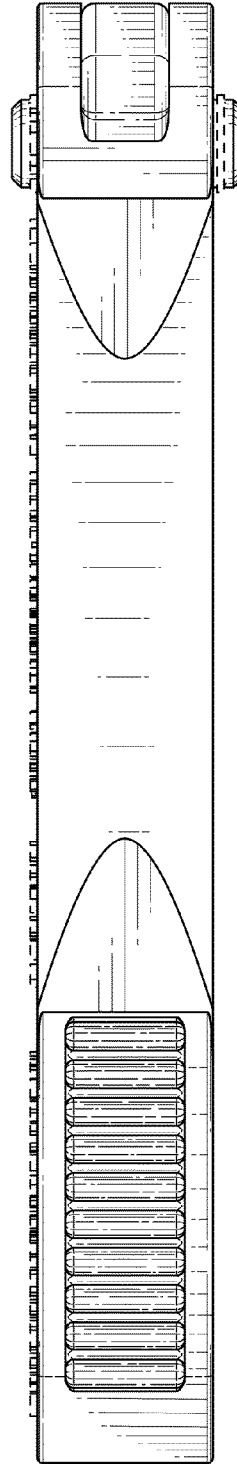

FIG. 6

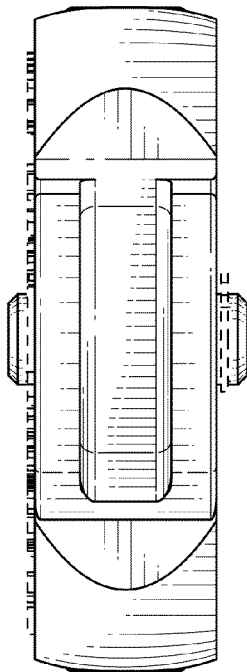

FIG. 7

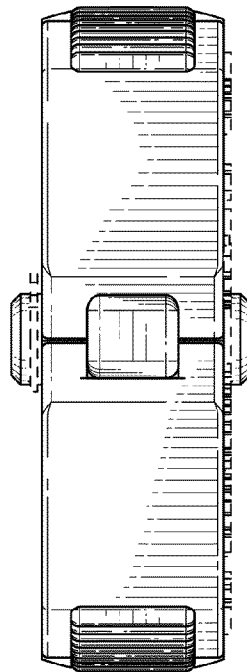

FIG. 8

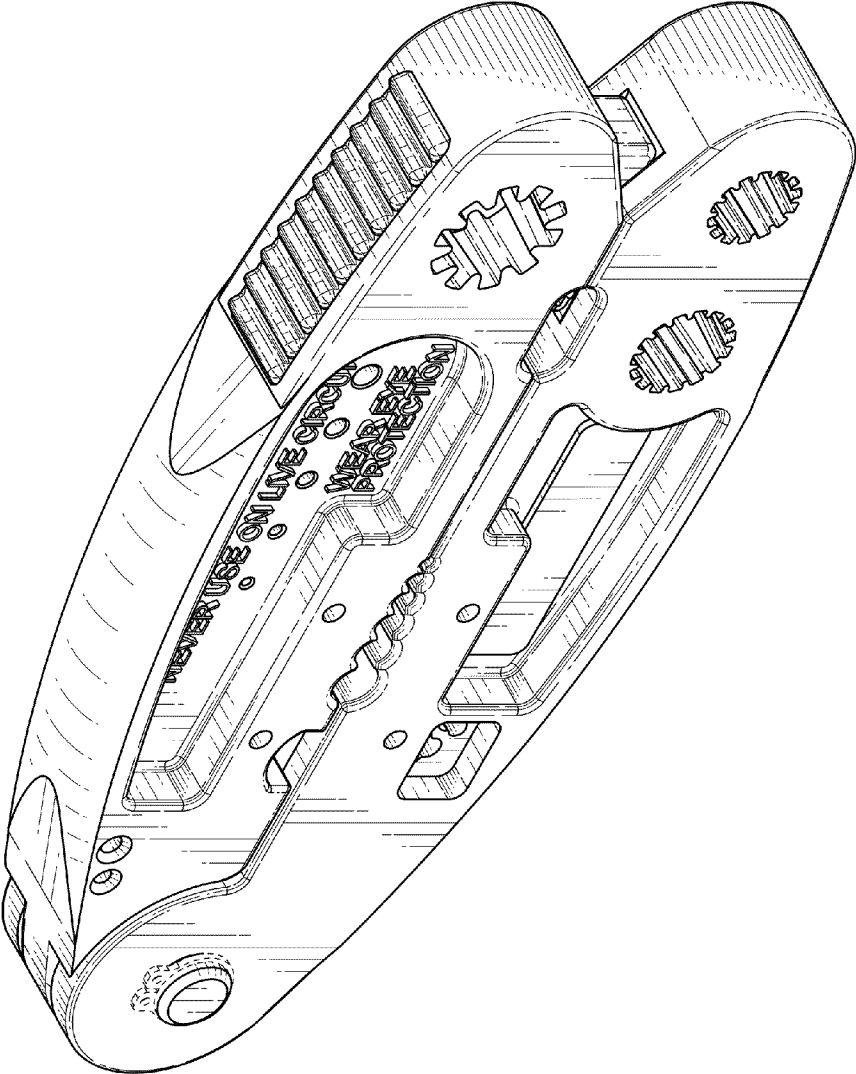

FIG. 10

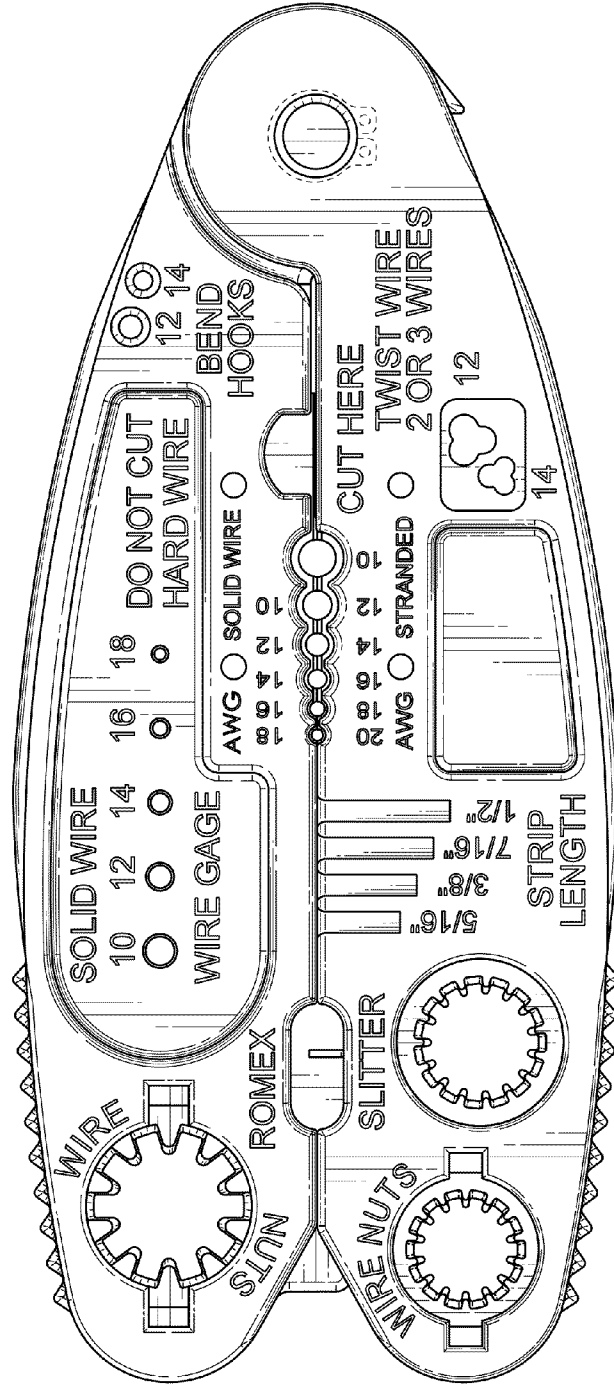

FIG. 11

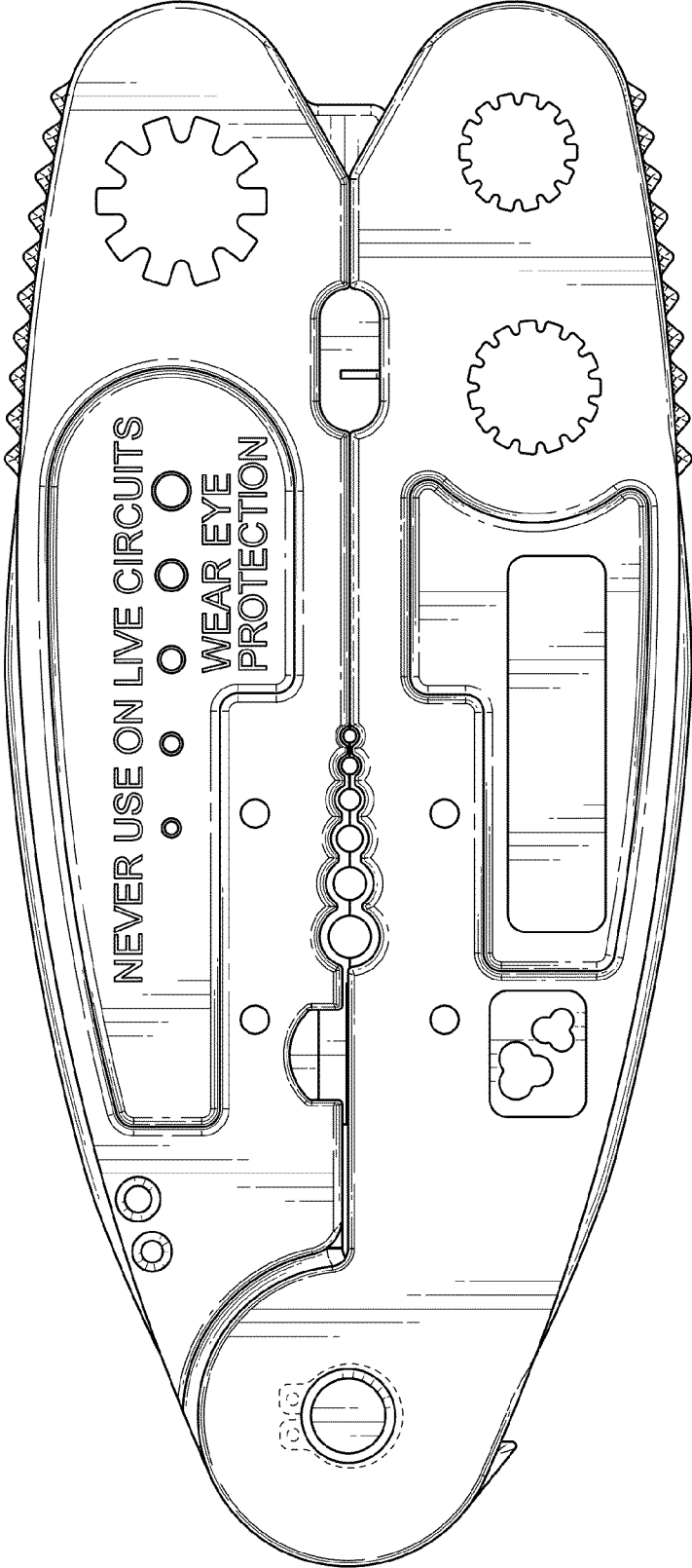

FIG. 12

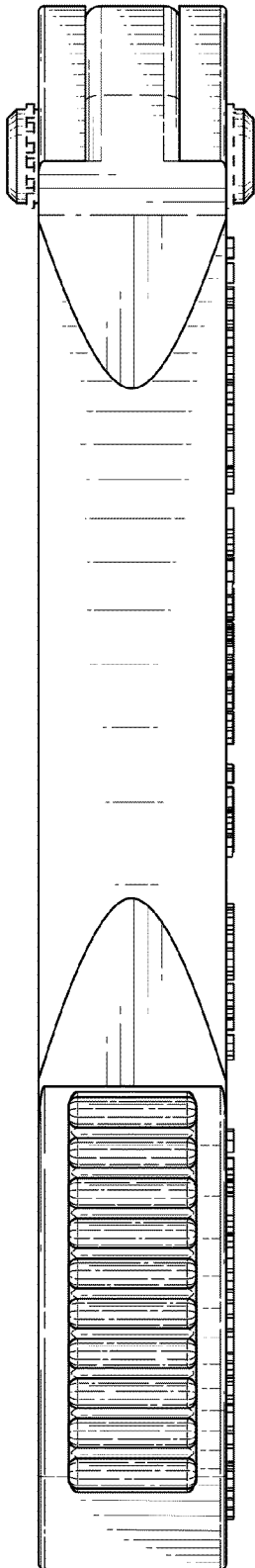

FIG. 13

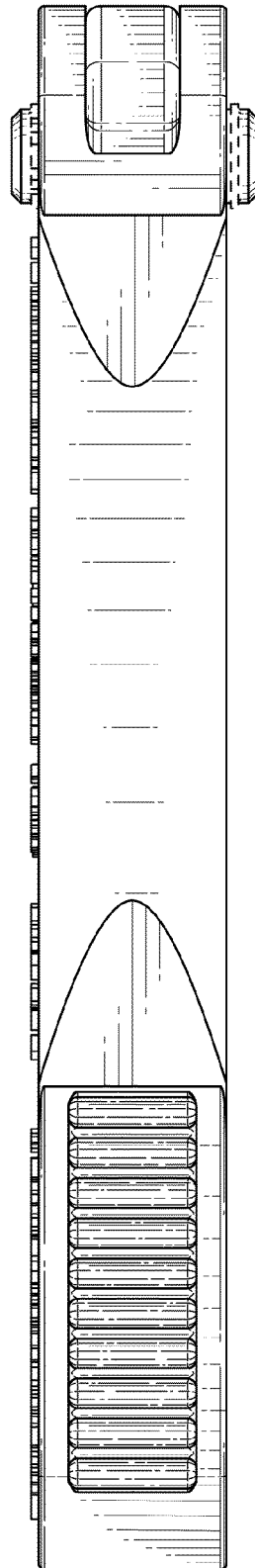

FIG. 14

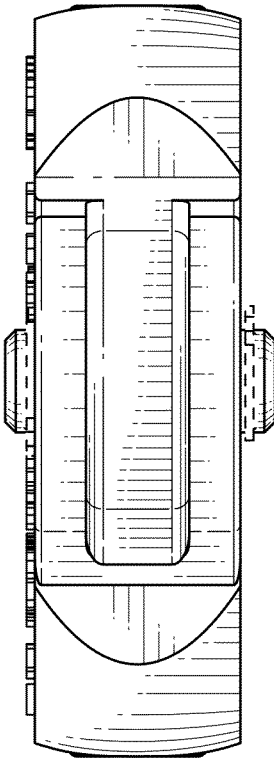

FIG. 15

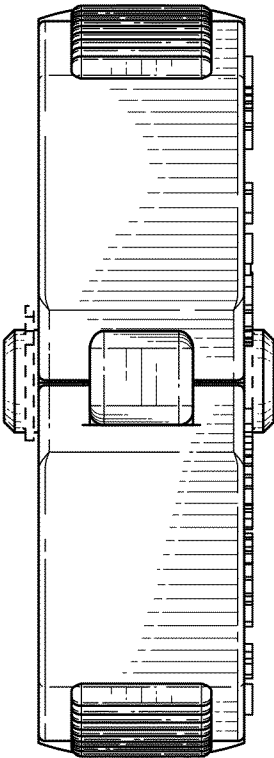

FIG. 16