



(19) **United States**  
(12) **Patent Application Publication**  
**Silverbrook et al.**

(10) **Pub. No.: US 2009/0077385 A1**  
(43) **Pub. Date: Mar. 19, 2009**

(54) **AUTHENTICATING AN OBJECT**

**Publication Classification**

(75) Inventors: **Kia Silverbrook**, Balmain (AU);  
**Paul Lapstun**, Balmain (AU)

(51) **Int. Cl.**  
**H04L 9/00** (2006.01)  
(52) **U.S. Cl.** ..... 713/176

Correspondence Address:  
**SILVERBROOK RESEARCH PTY LTD**  
**393 DARLING STREET**  
**BALMAIN 2041 (AU)**

(57) **ABSTRACT**

A method of authenticating an object is disclosed. The method starts by receiving indicating data. The indicating data was generated in response to sensing of a coded data portion provided on or in a surface associated with the object. The indicating data is indicative of an identity, a position of the coded data portion, and a fragment of a signature. The signature is a digital signature of at least the identity, and comprises a plurality of signature fragments. The method then proceeds by determining from the indicating data, a received identity, a received signature fragment and the position of the coded data portion. Using the position, a received signature fragment identifier is then determined. Next, using the received identity, a determined signature is determined. A determined signature fragment is also determined using the determined signature and the received signature fragment identifier. Finally, the determined signature fragment is compared to the received signature fragment, and the object is authenticated using the result of the comparison.

(73) Assignee: **Silverbrook Research Pty Ltd**

(21) Appl. No.: **12/273,458**

(22) Filed: **Nov. 18, 2008**

**Related U.S. Application Data**

(63) Continuation of application No. 11/863,267, filed on Sep. 28, 2007, now Pat. No. 7,467,301, which is a continuation of application No. 11/041,648, filed on Jan. 25, 2005.

**Foreign Application Priority Data**

May 18, 2004 (AU) ..... 2004902623

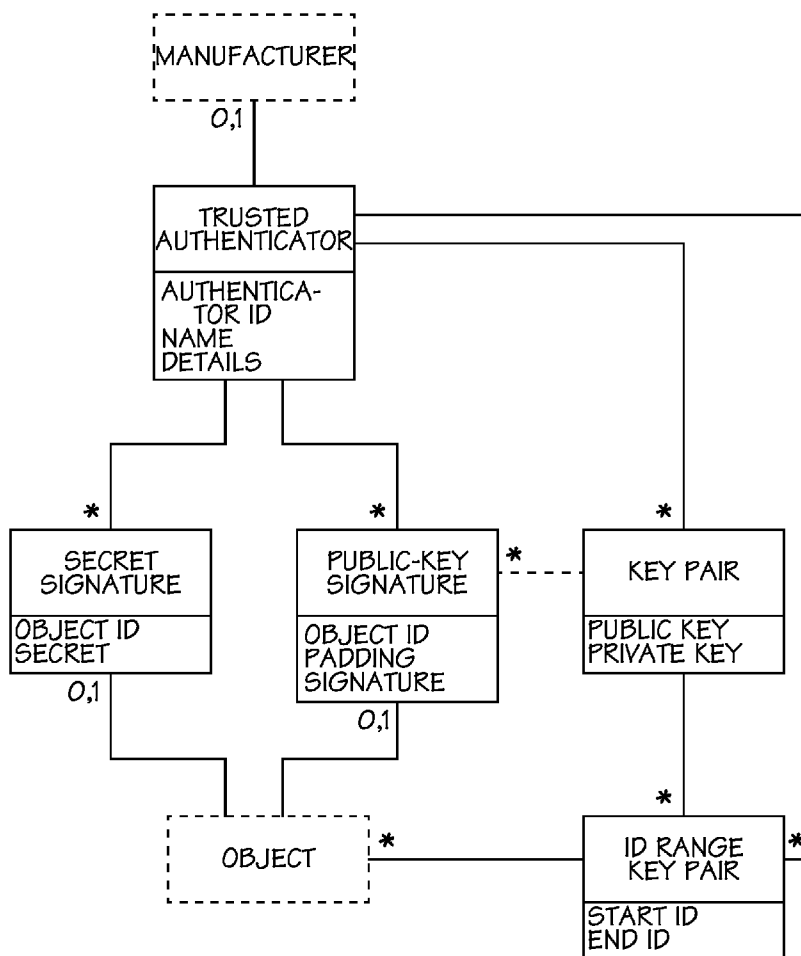

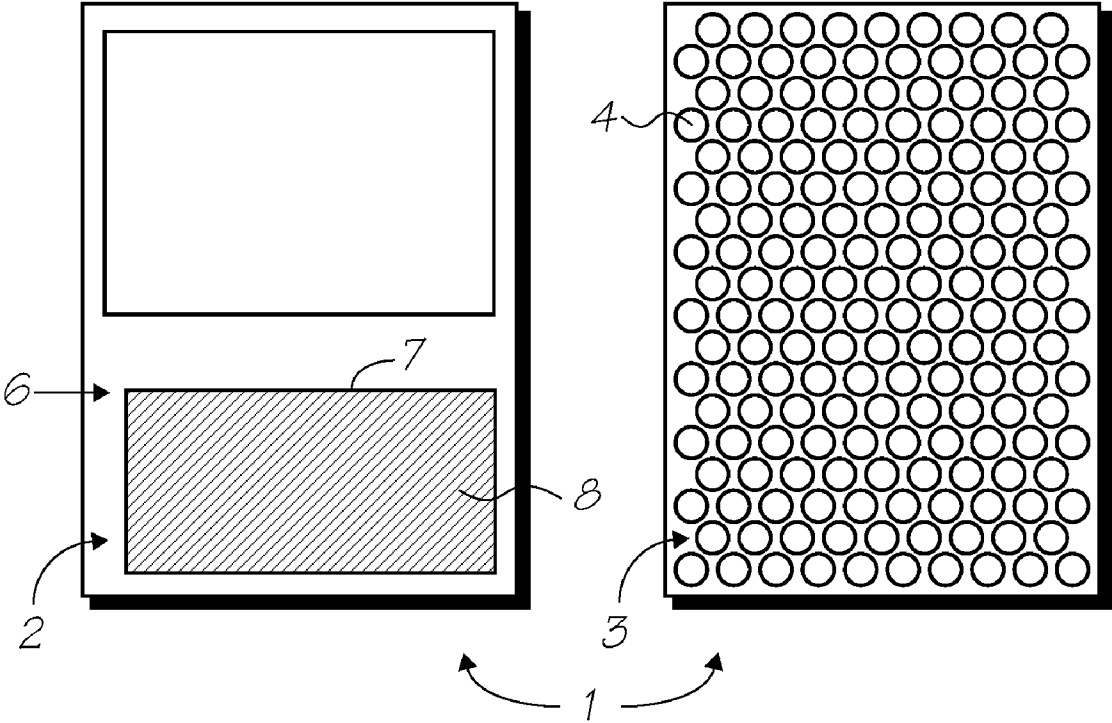

FIG. 1

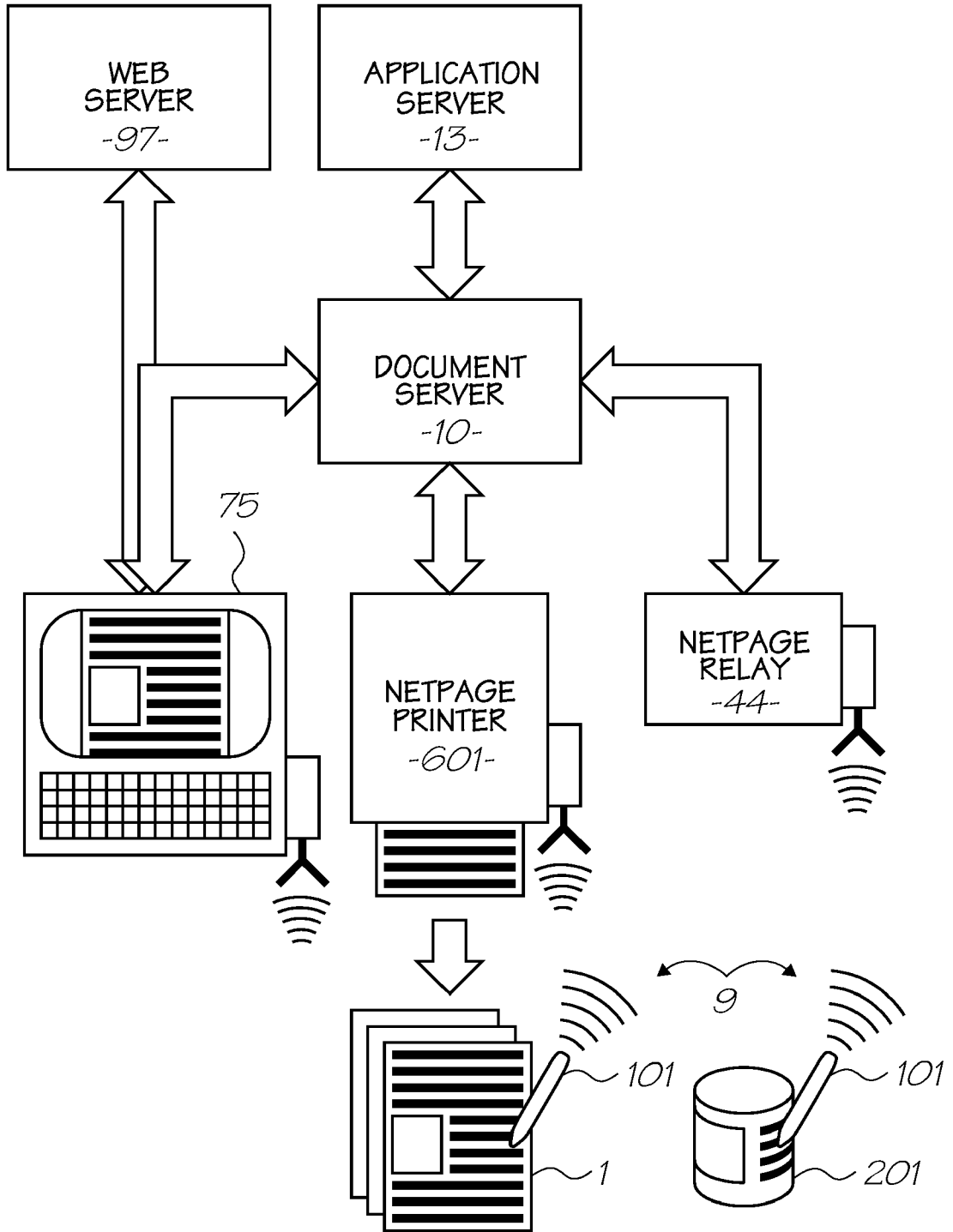

FIG. 2

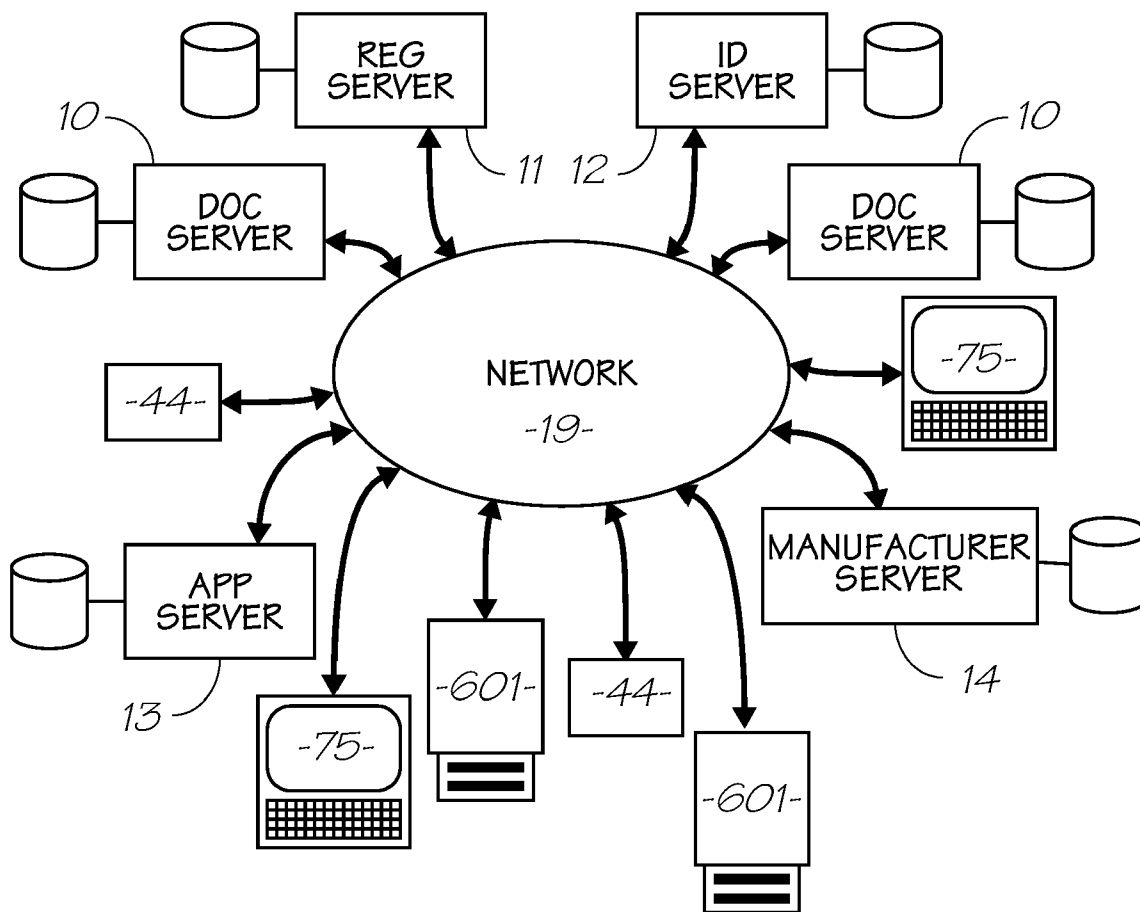

FIG. 3

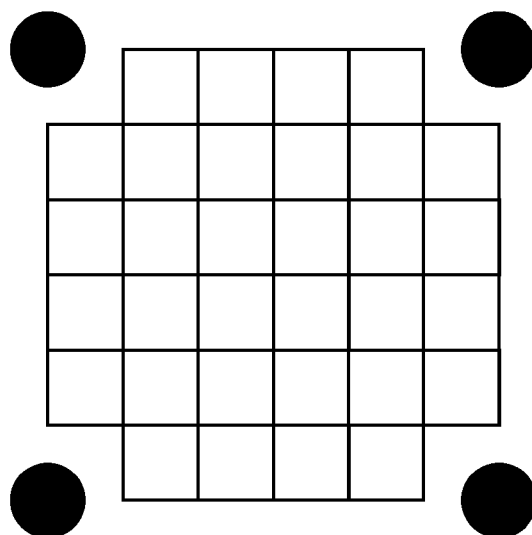

FIG. 4

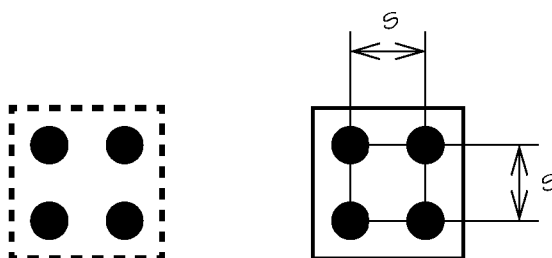

FIG. 5

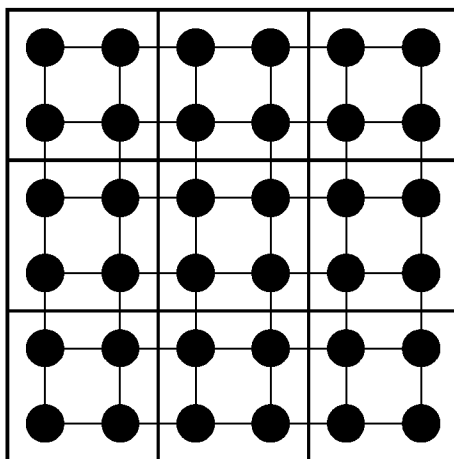

FIG. 6

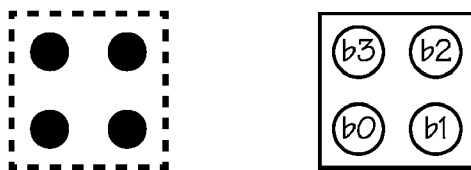

FIG. 7

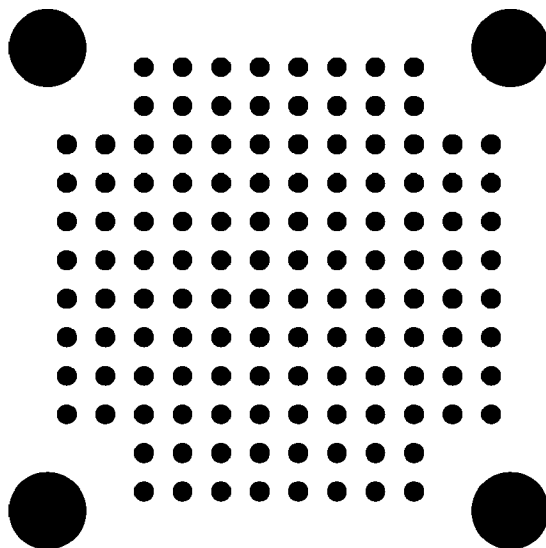

FIG. 8

00	10
01	11

FIG. 9

00	10	00	10	00	10
01	11	01	11	01	11
00	10	00	10	00	10
01	11	01	11	01	11

FIG. 10

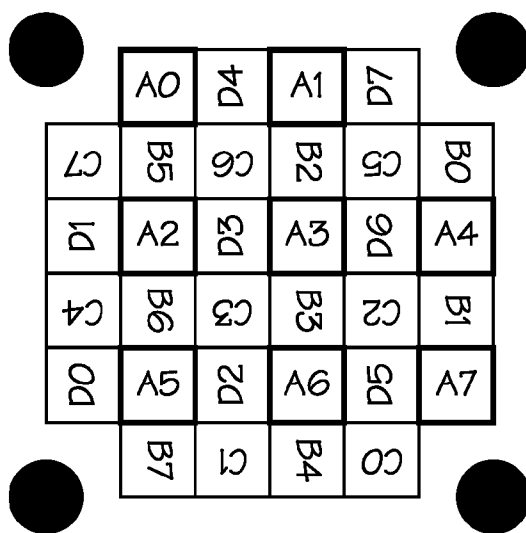

FIG. 11

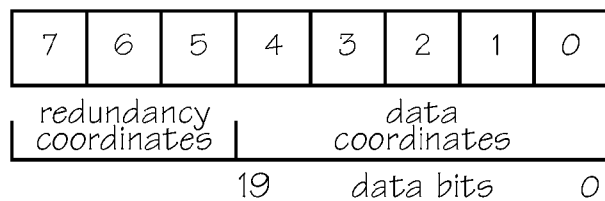

FIG. 12

3	2	1
4	-	0
5	6	7

FIG. 13

00	10
01	11

FIG. 14

00	10	00	10	00	10
01	11	01	11	01	11
00	10	00	10	00	10
01	11	01	11	01	11

FIG. 15

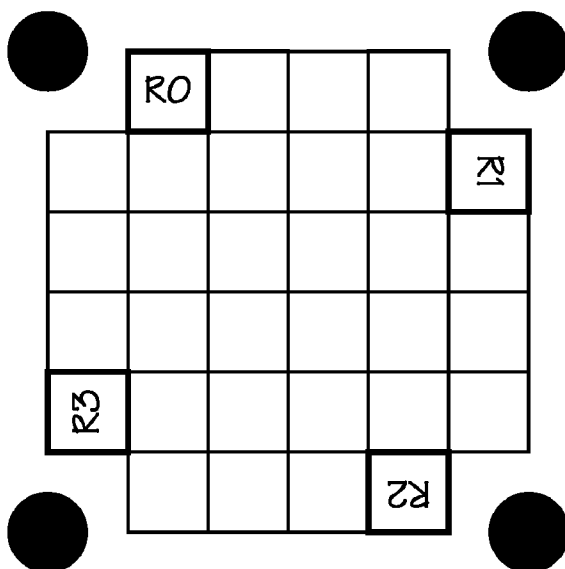

FIG. 16

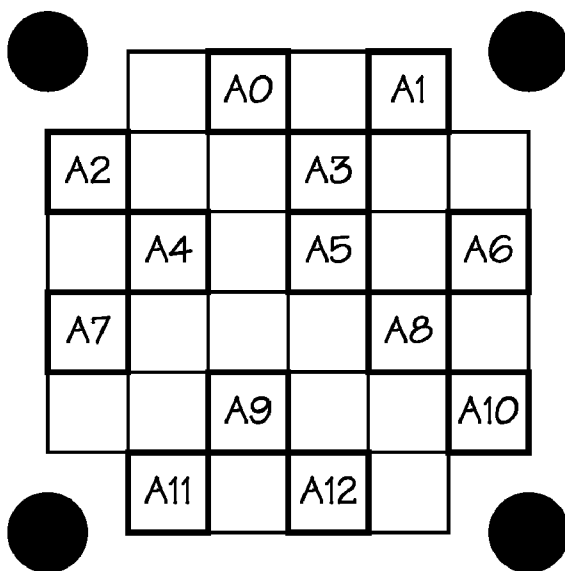

FIG. 17

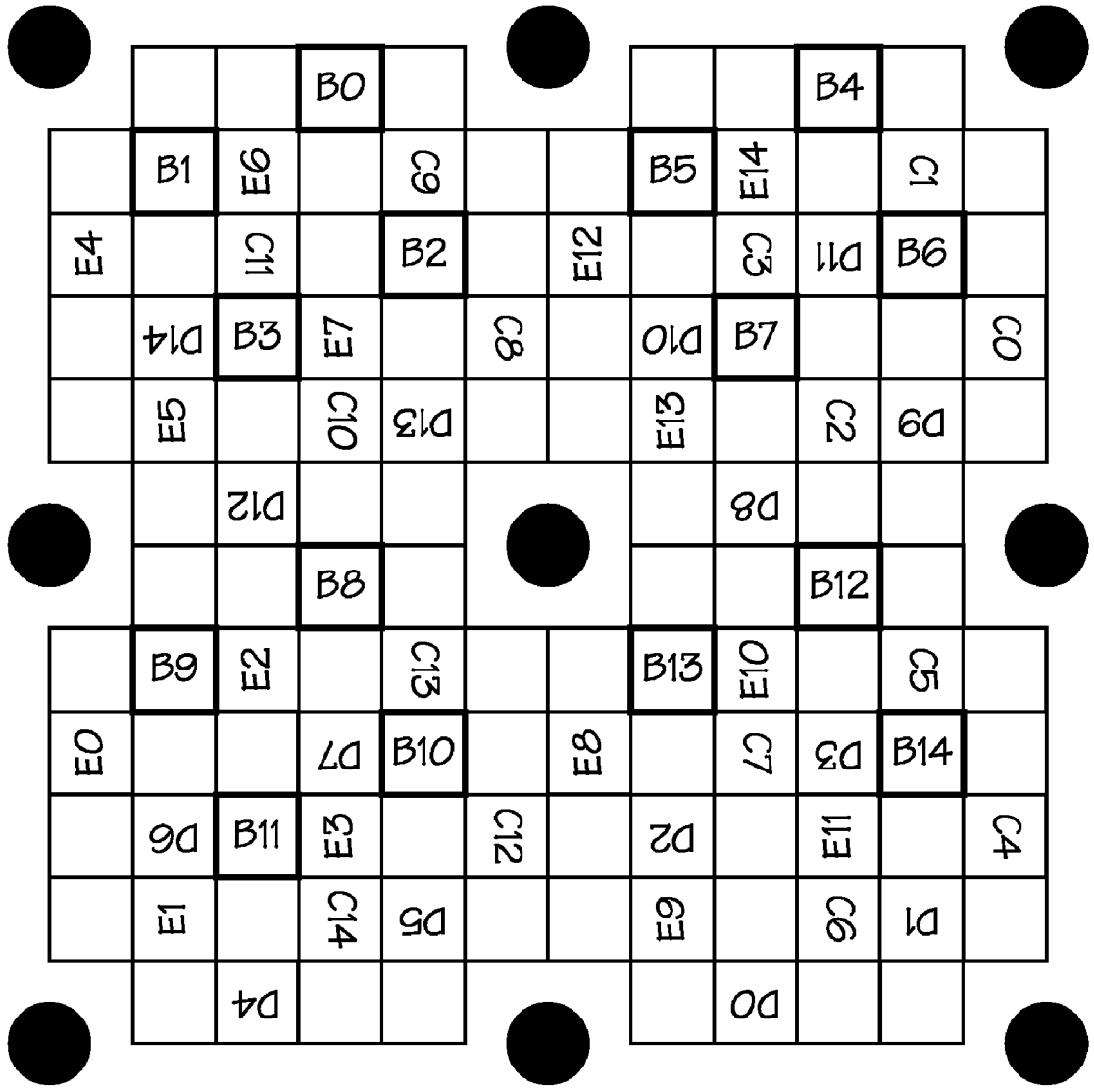

FIG. 18

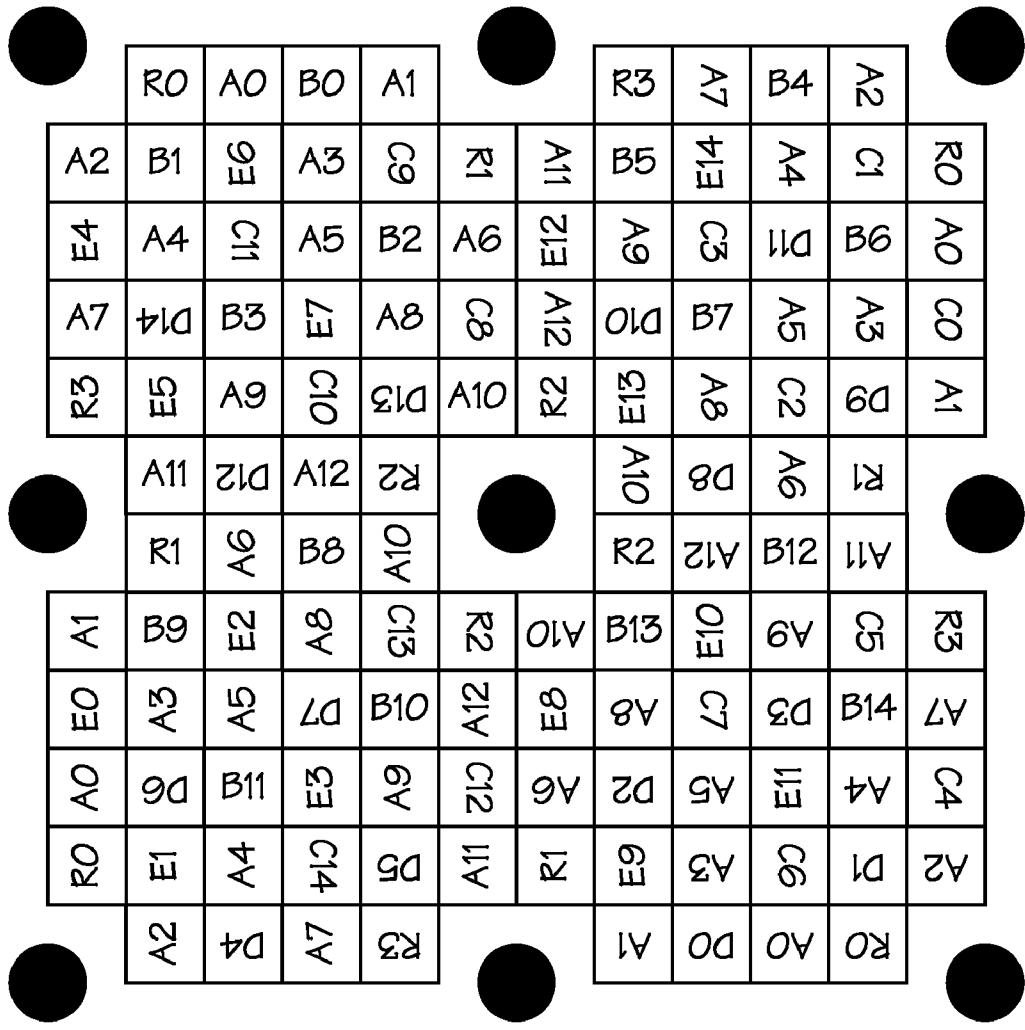

FIG. 19

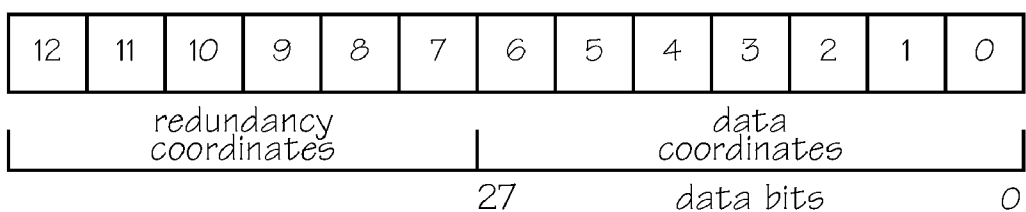
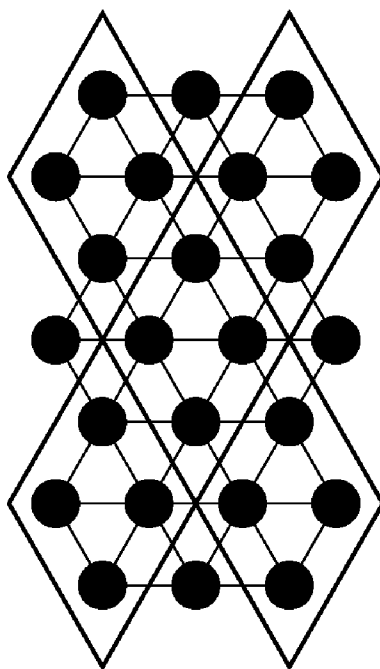
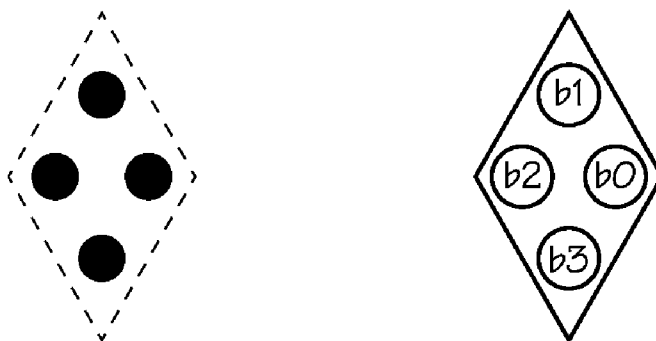

FIG. 20

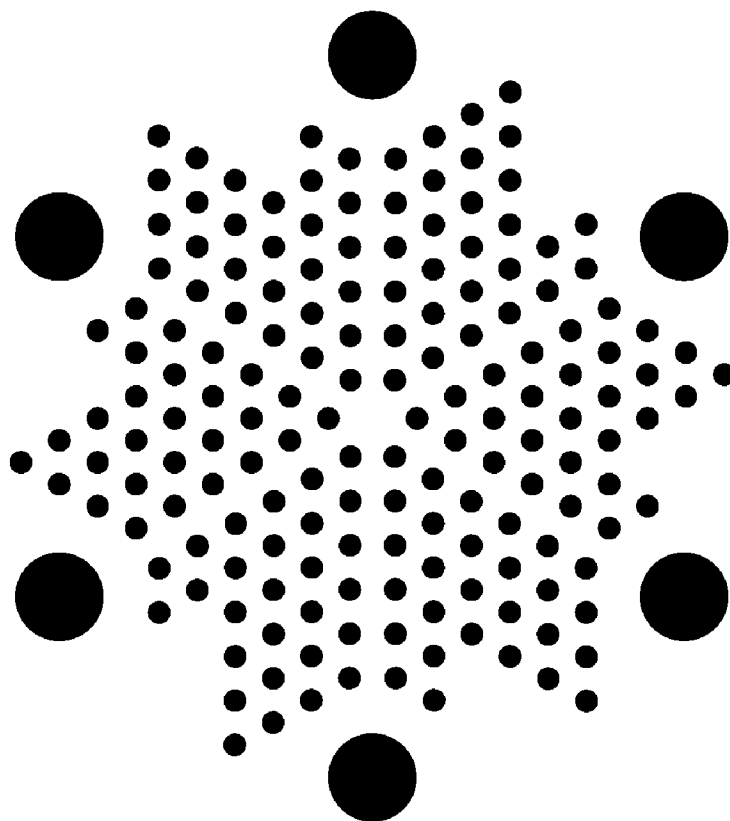



*FIG. 23*



*FIG. 24*



*FIG. 25*

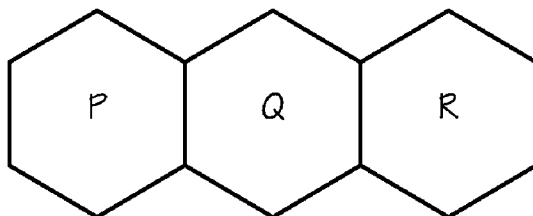

*FIG. 26*

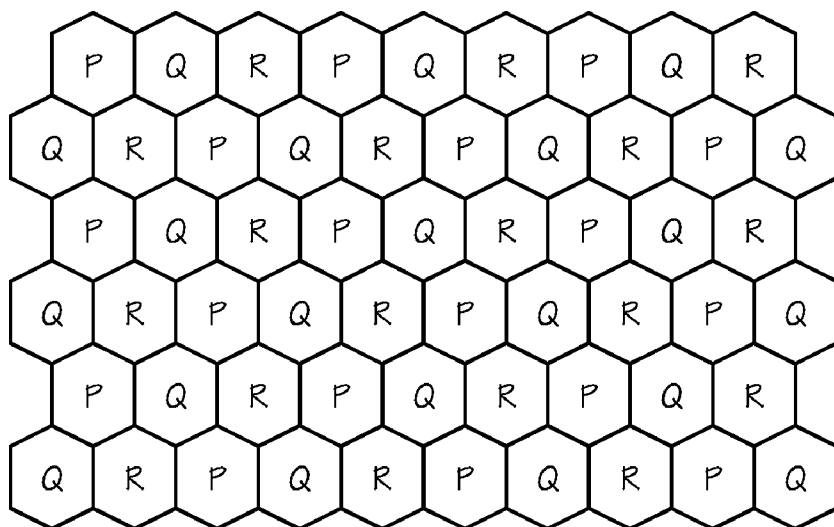

FIG. 27

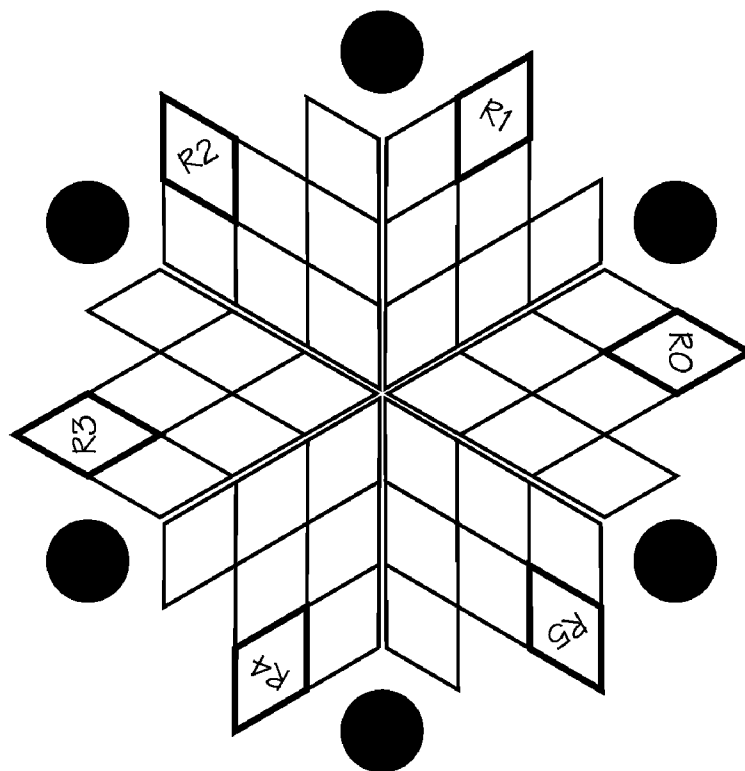

FIG. 28

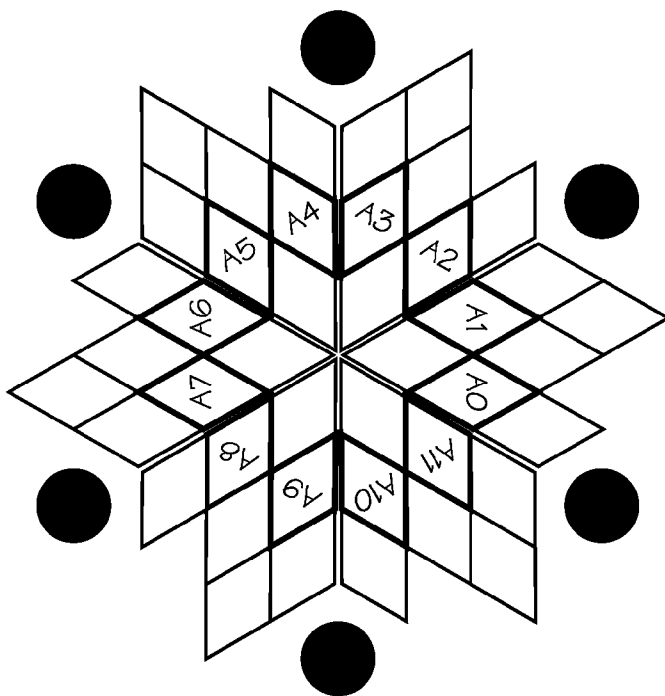

FIG. 29

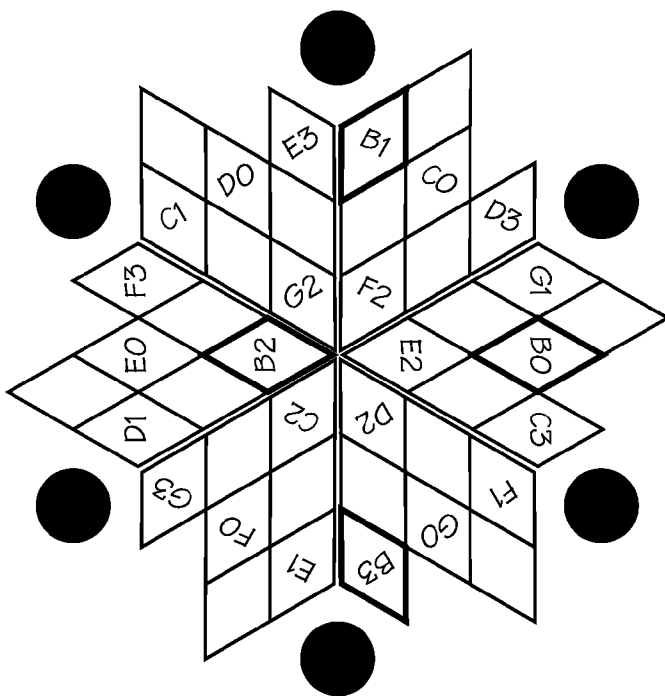

FIG. 30

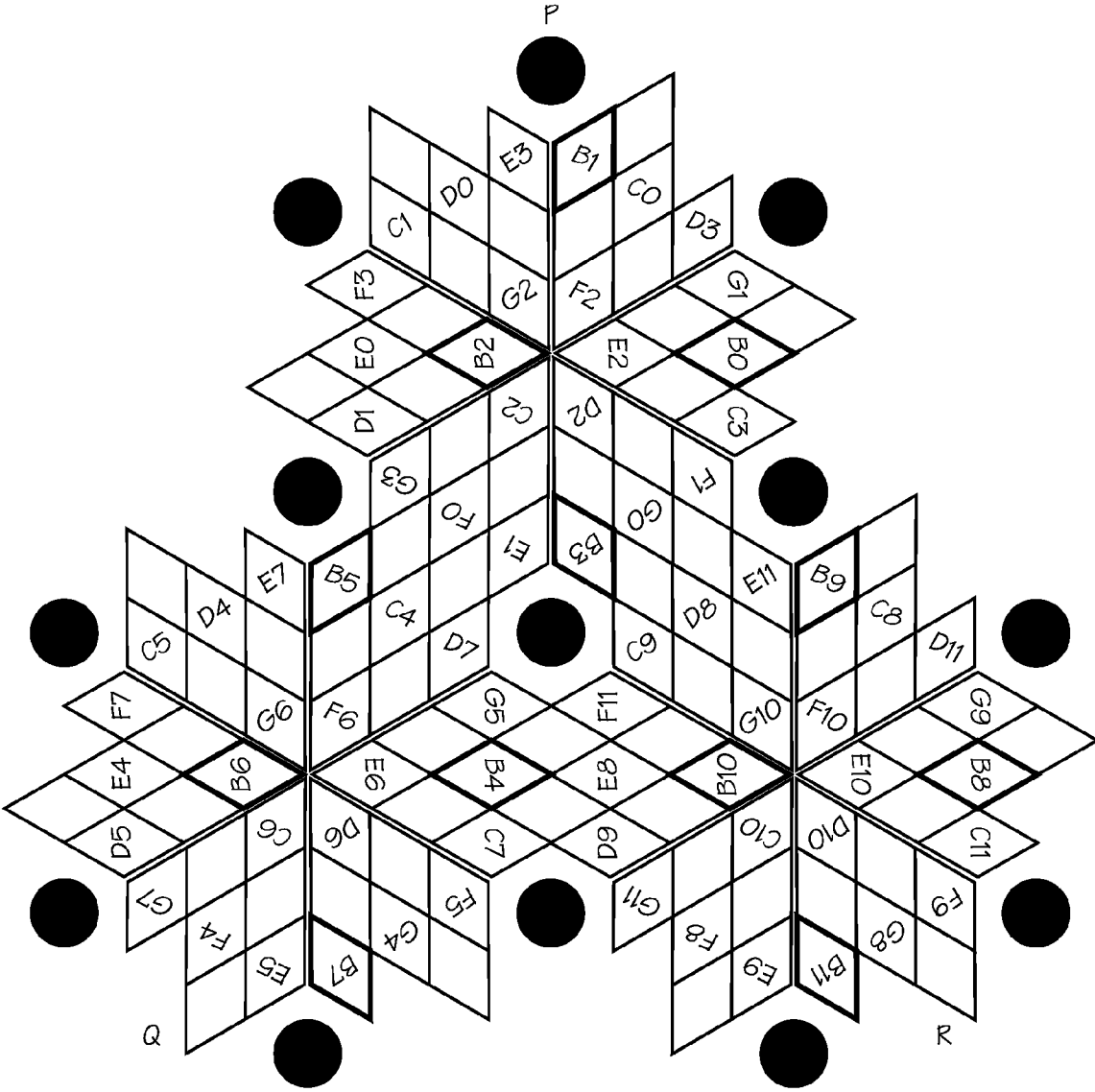

FIG. 31

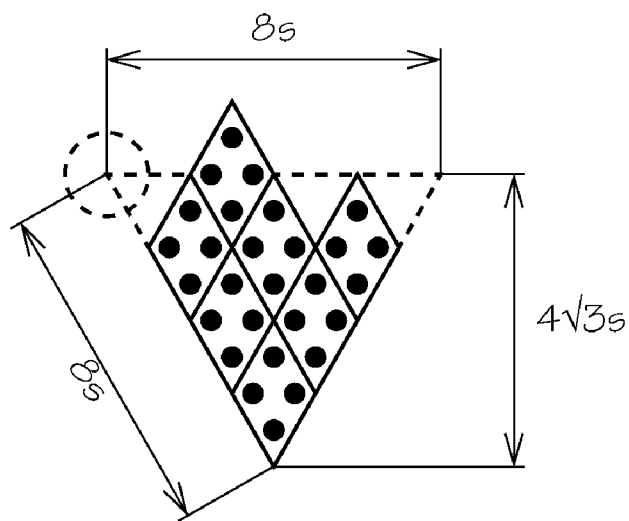

FIG. 32

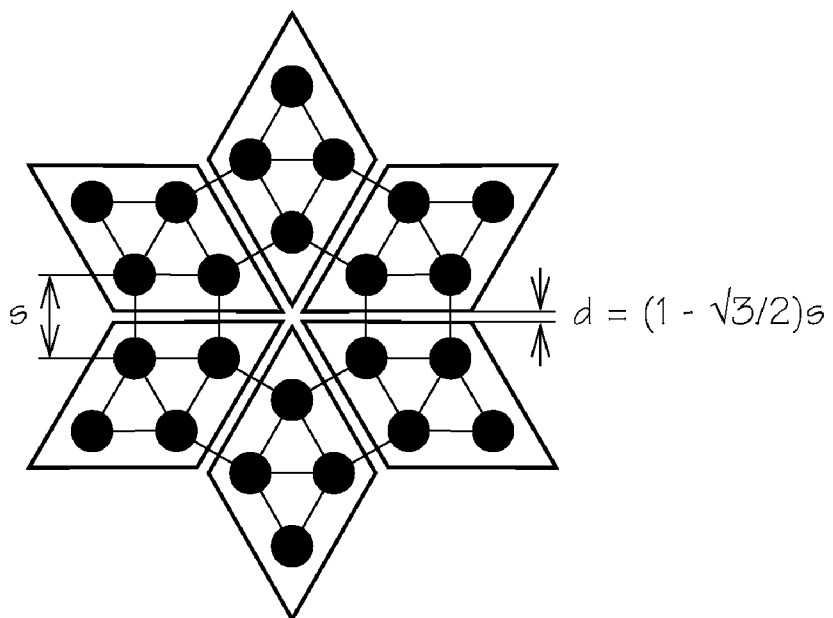

FIG. 33

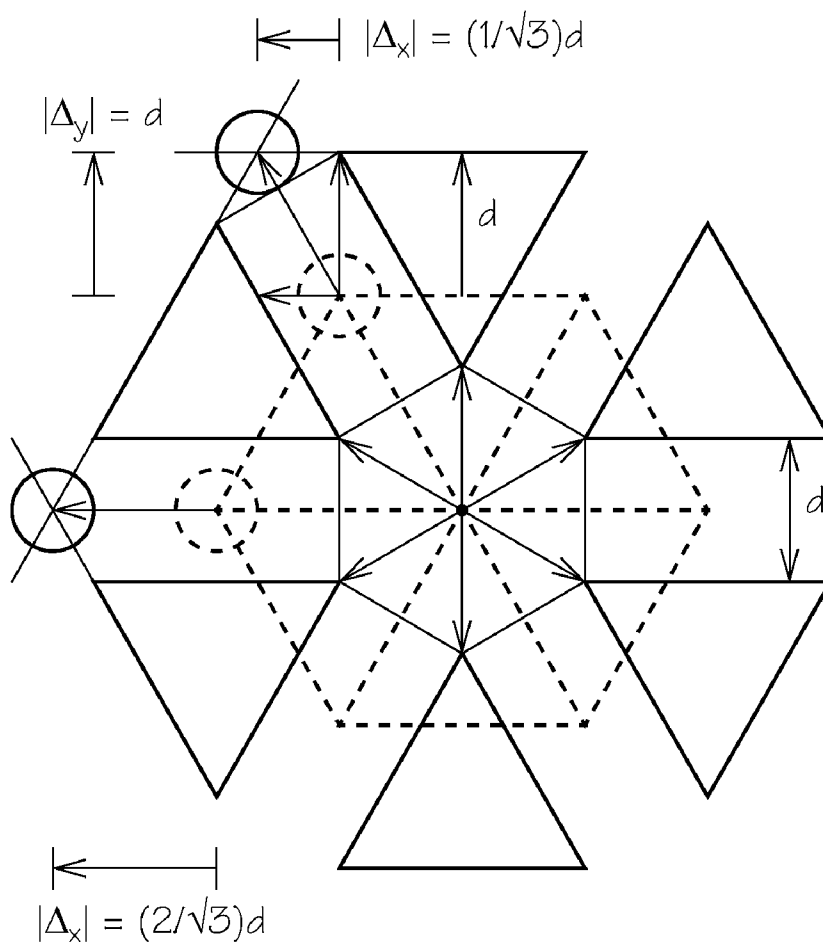

FIG. 34

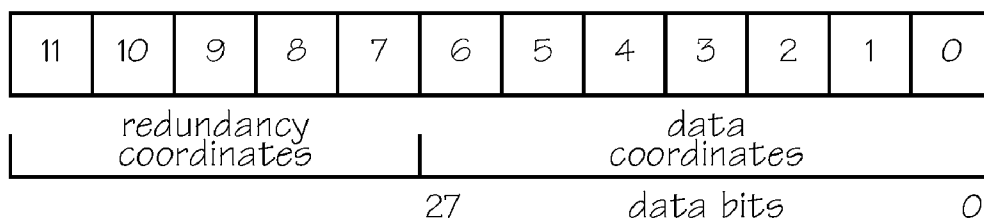

FIG. 35

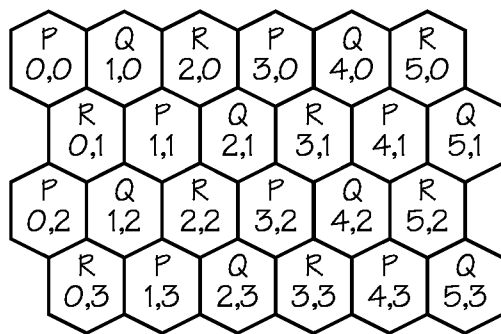

FIG. 36

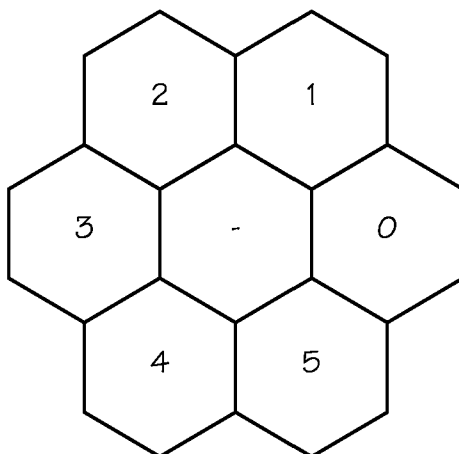

FIG. 37

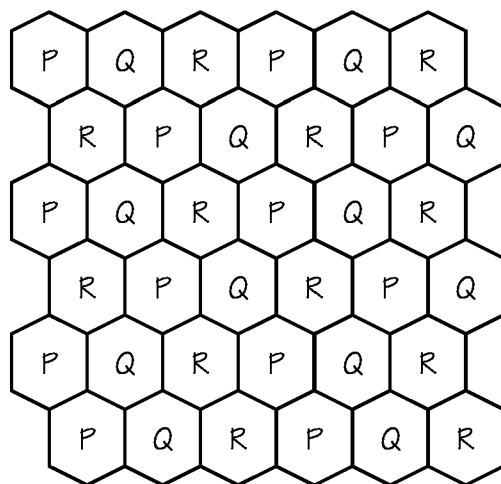

FIG. 38

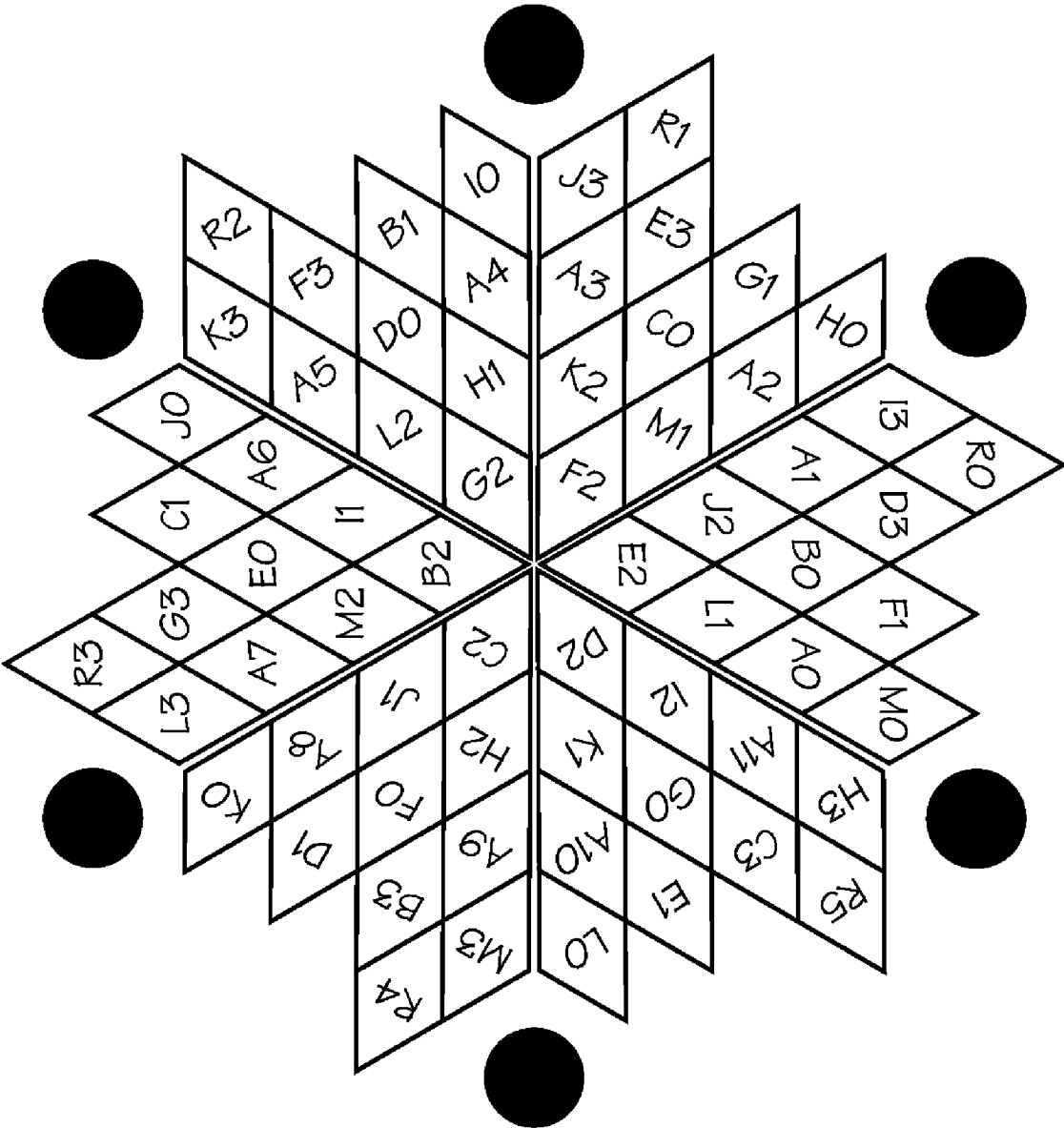

FIG. 39

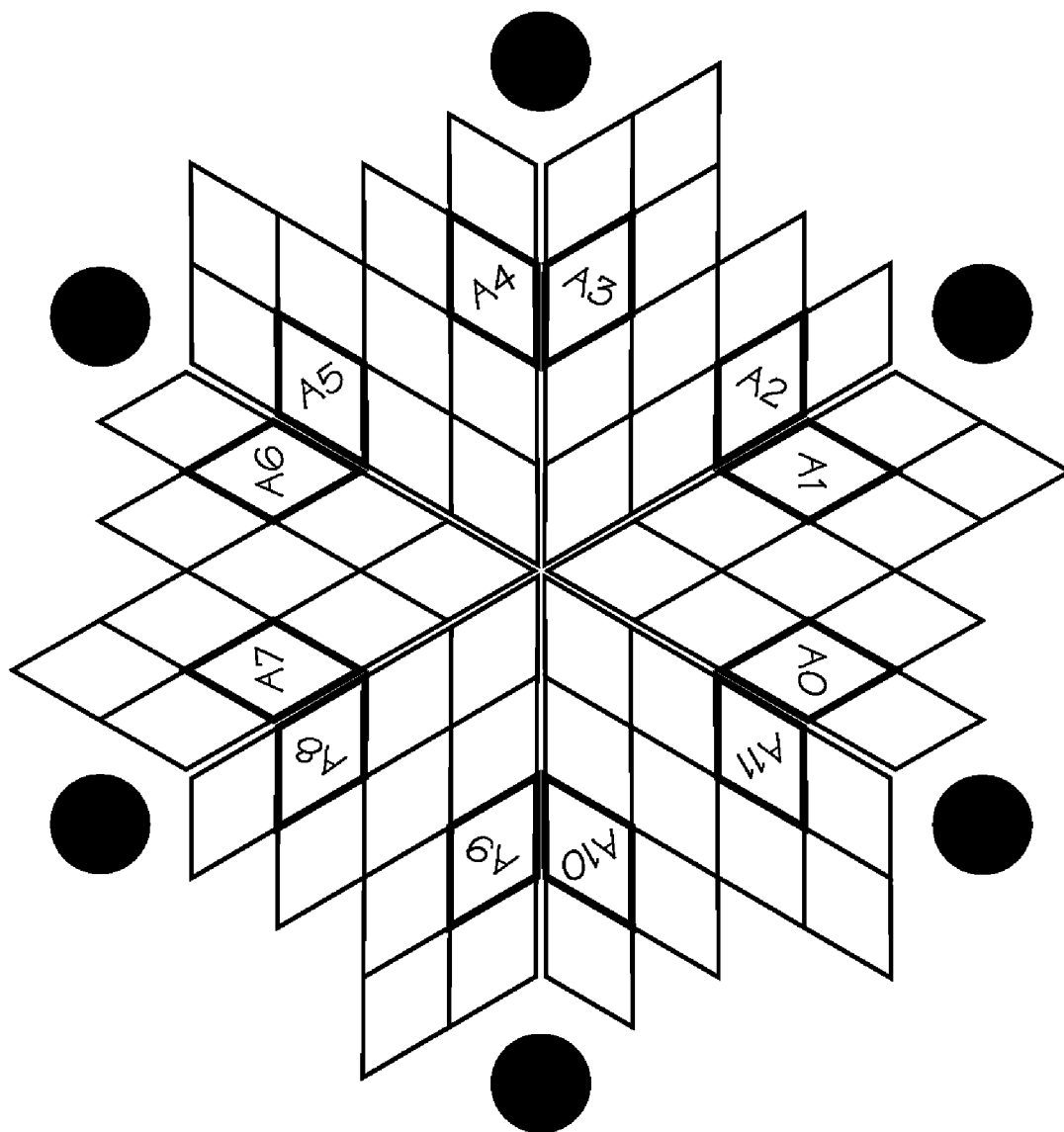

FIG. 40

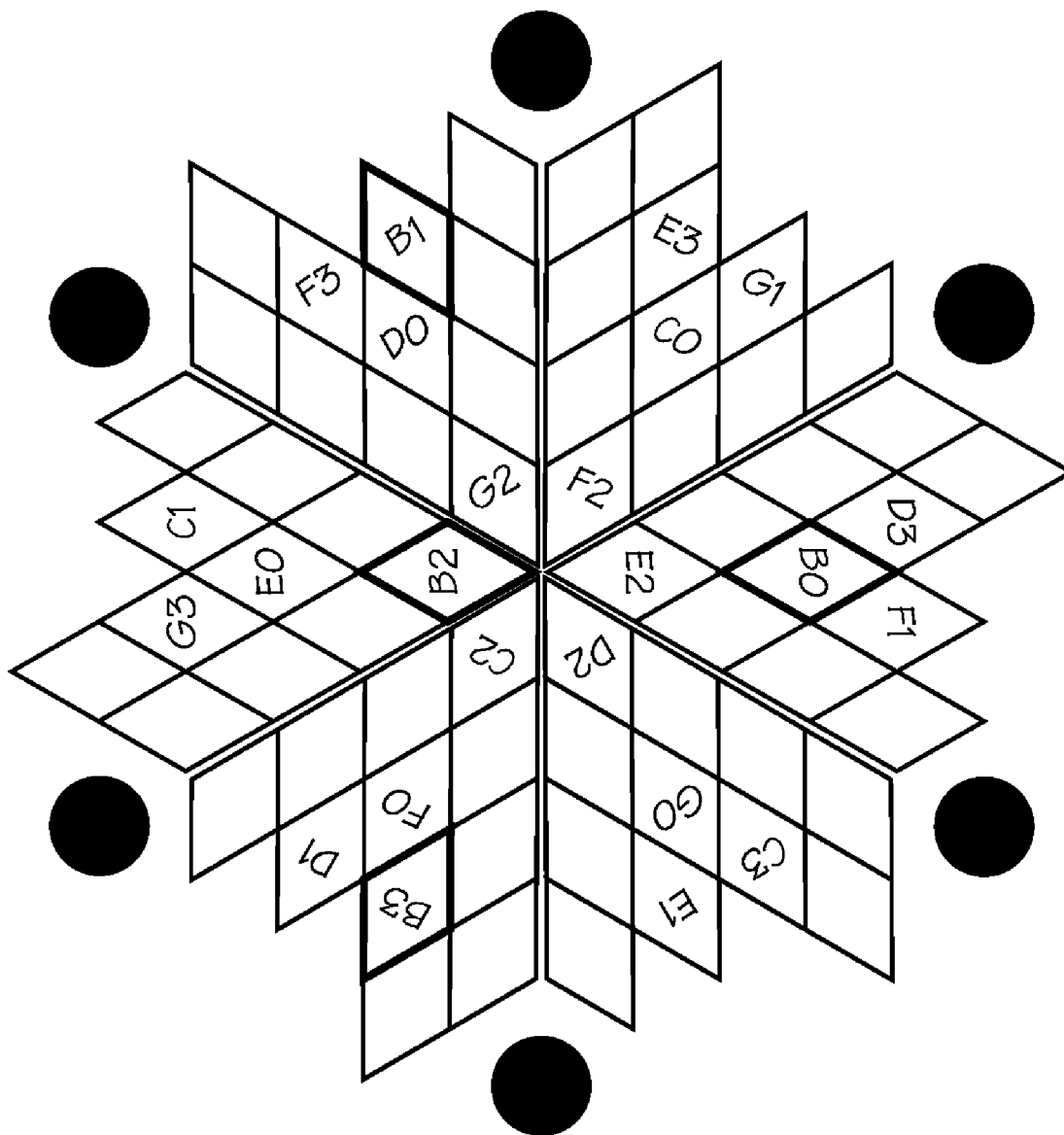

FIG. 41

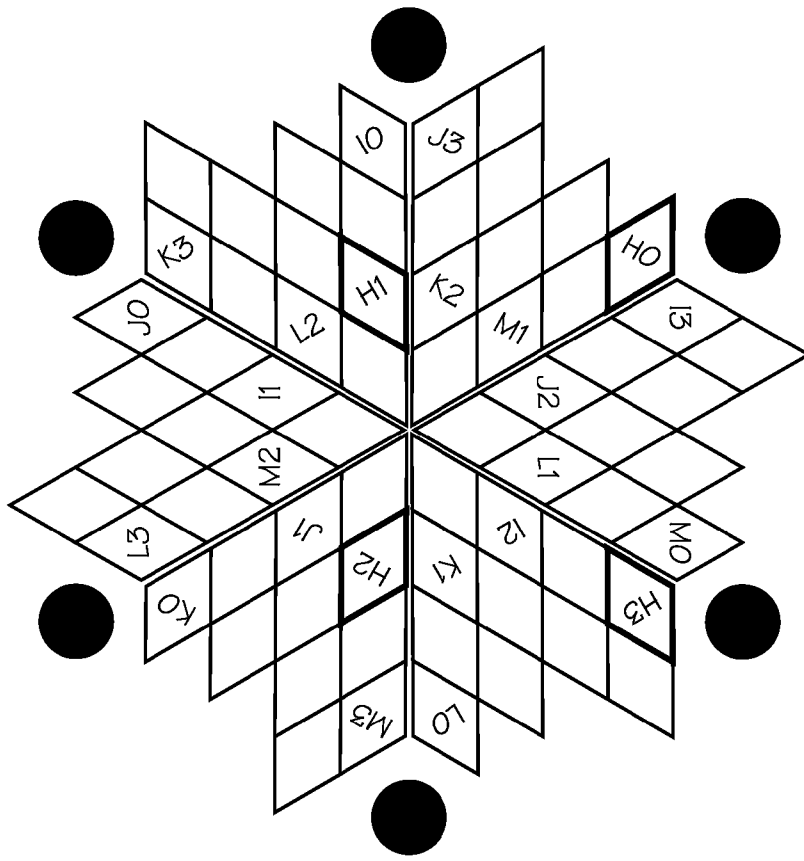

FIG. 42

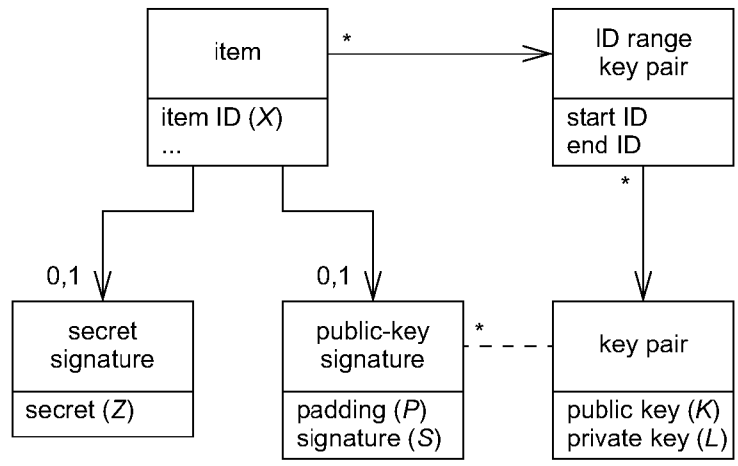

FIG. 43

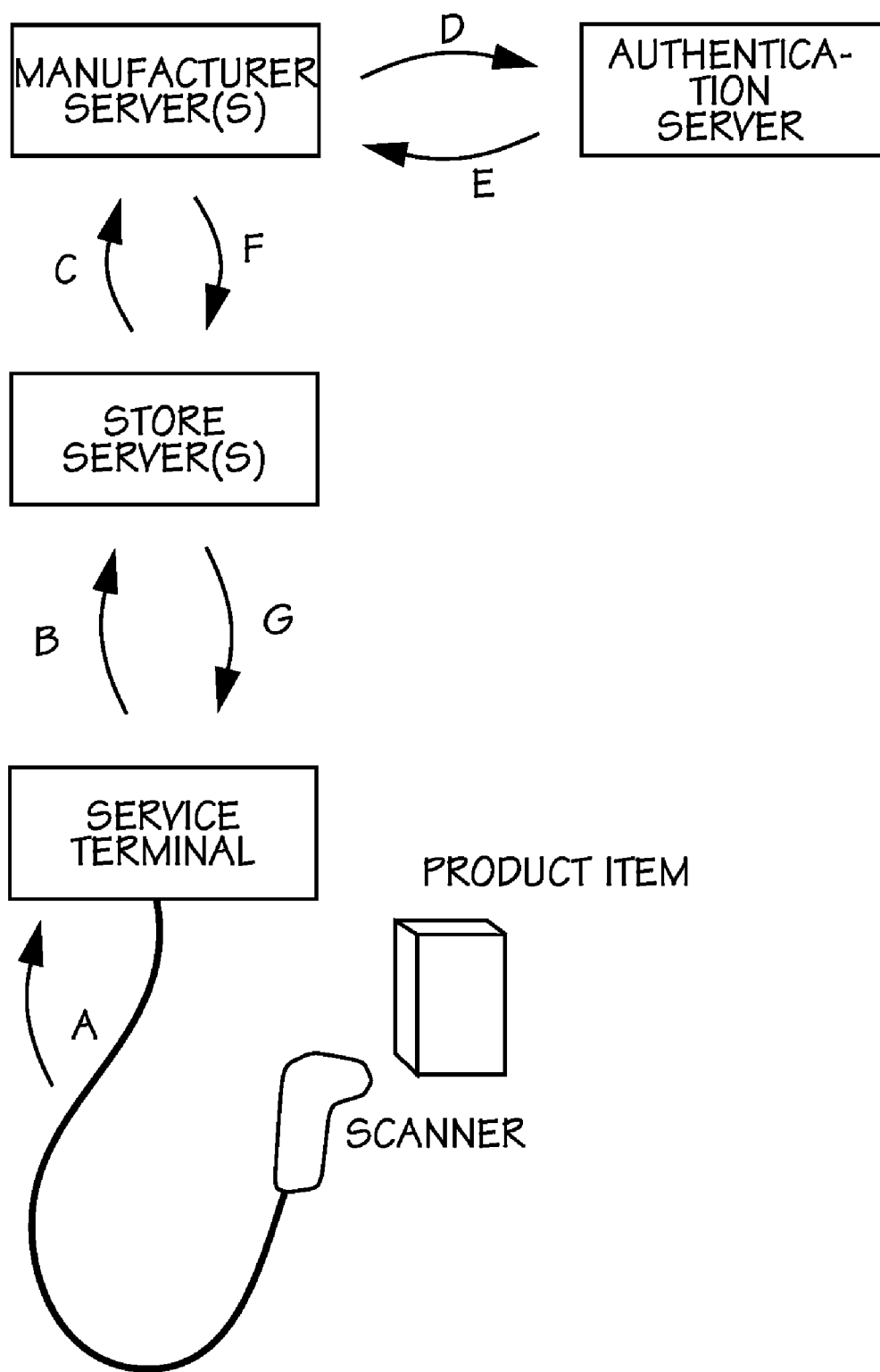

FIG. 44

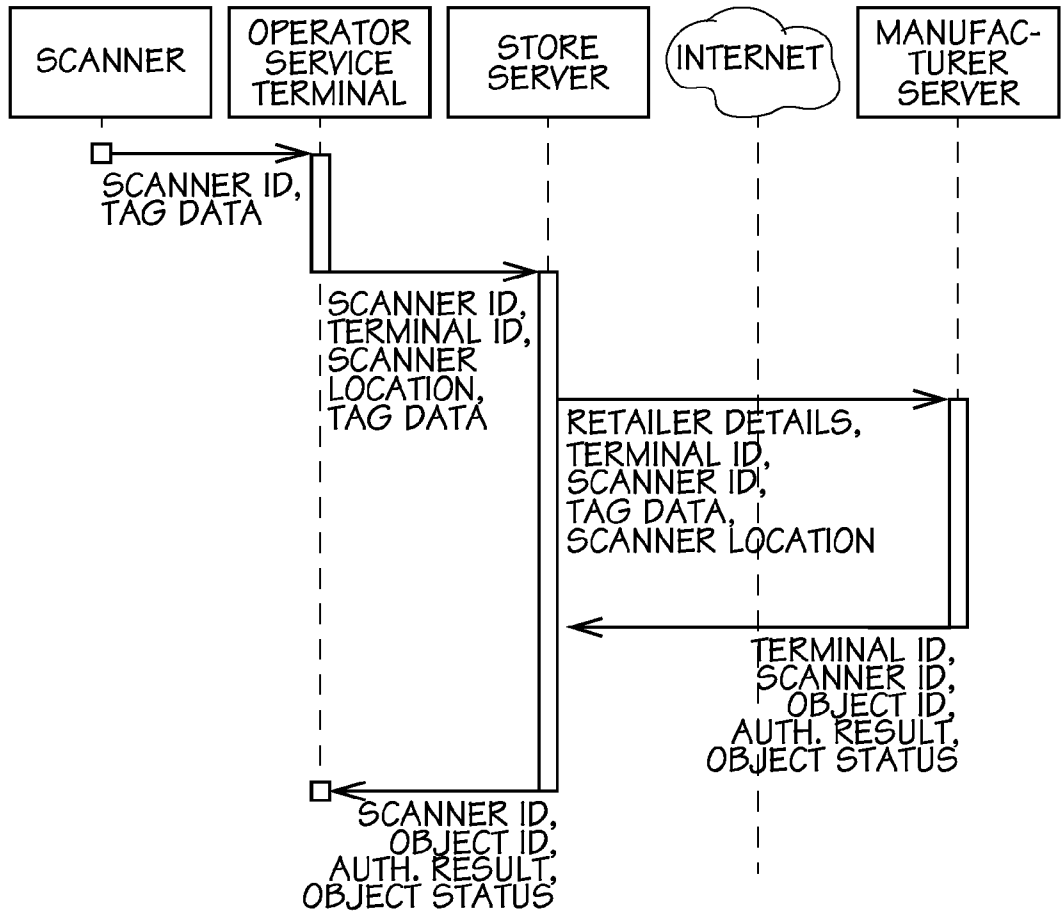

FIG. 45

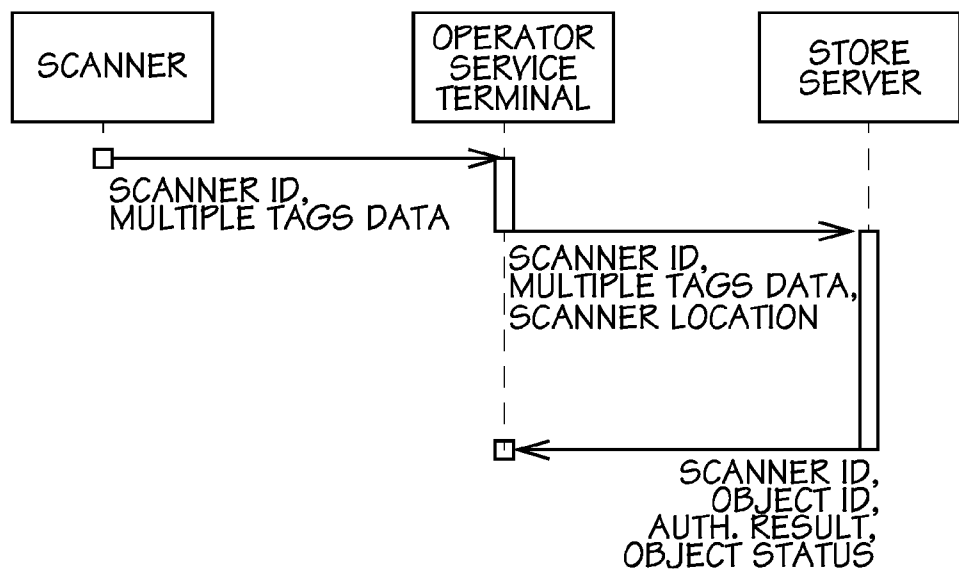

FIG. 46

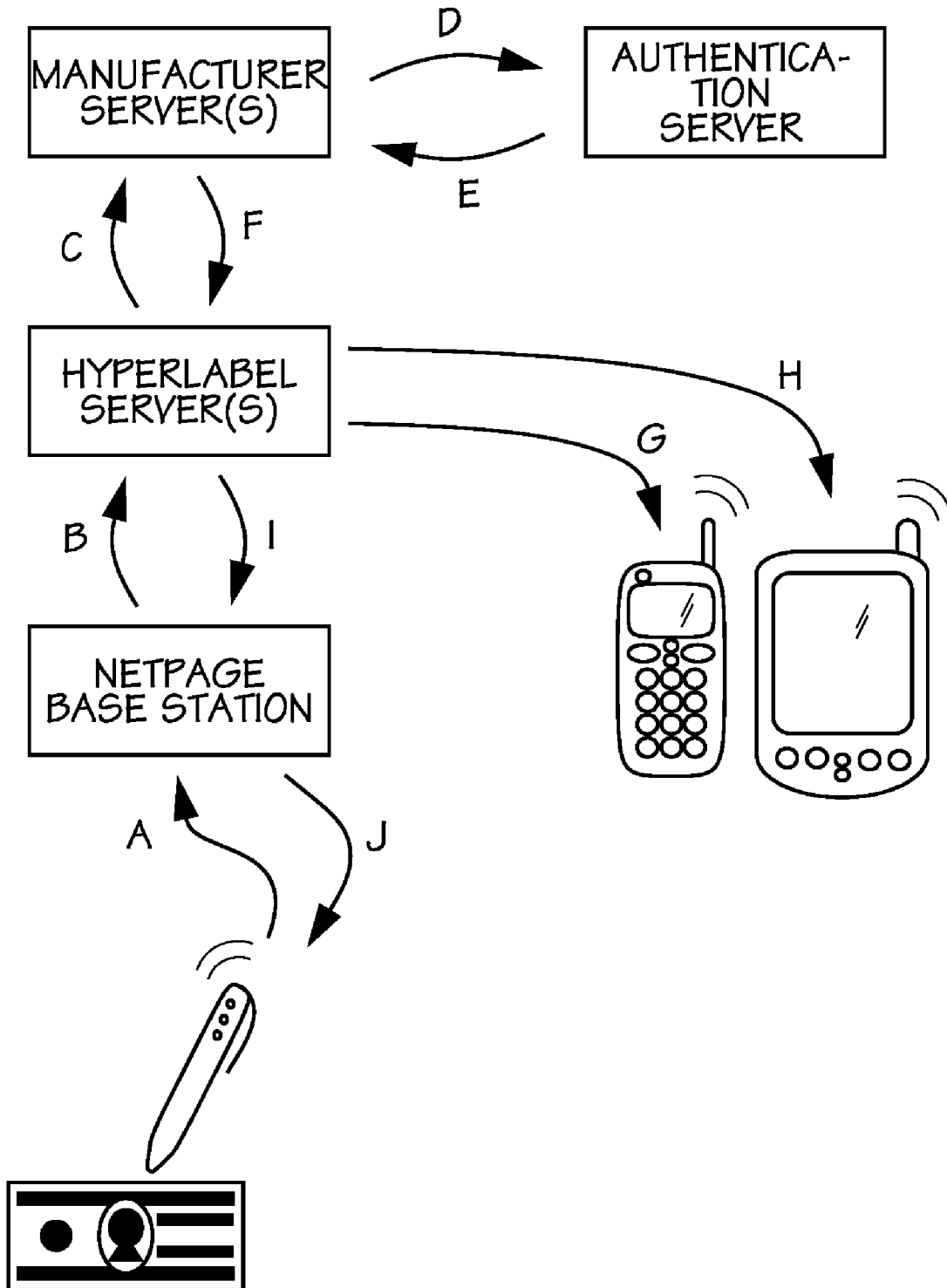

FIG. 47

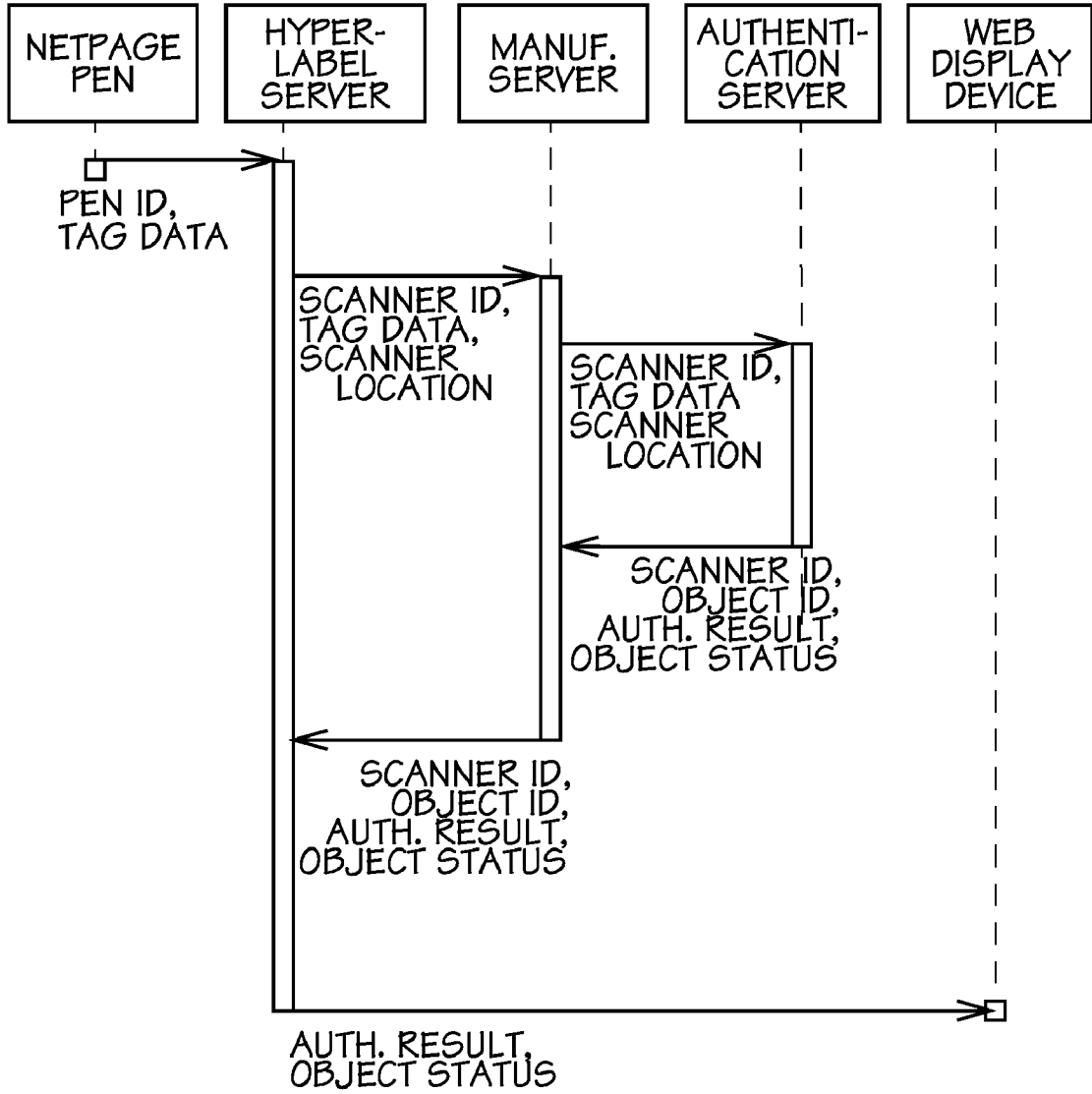

FIG. 48

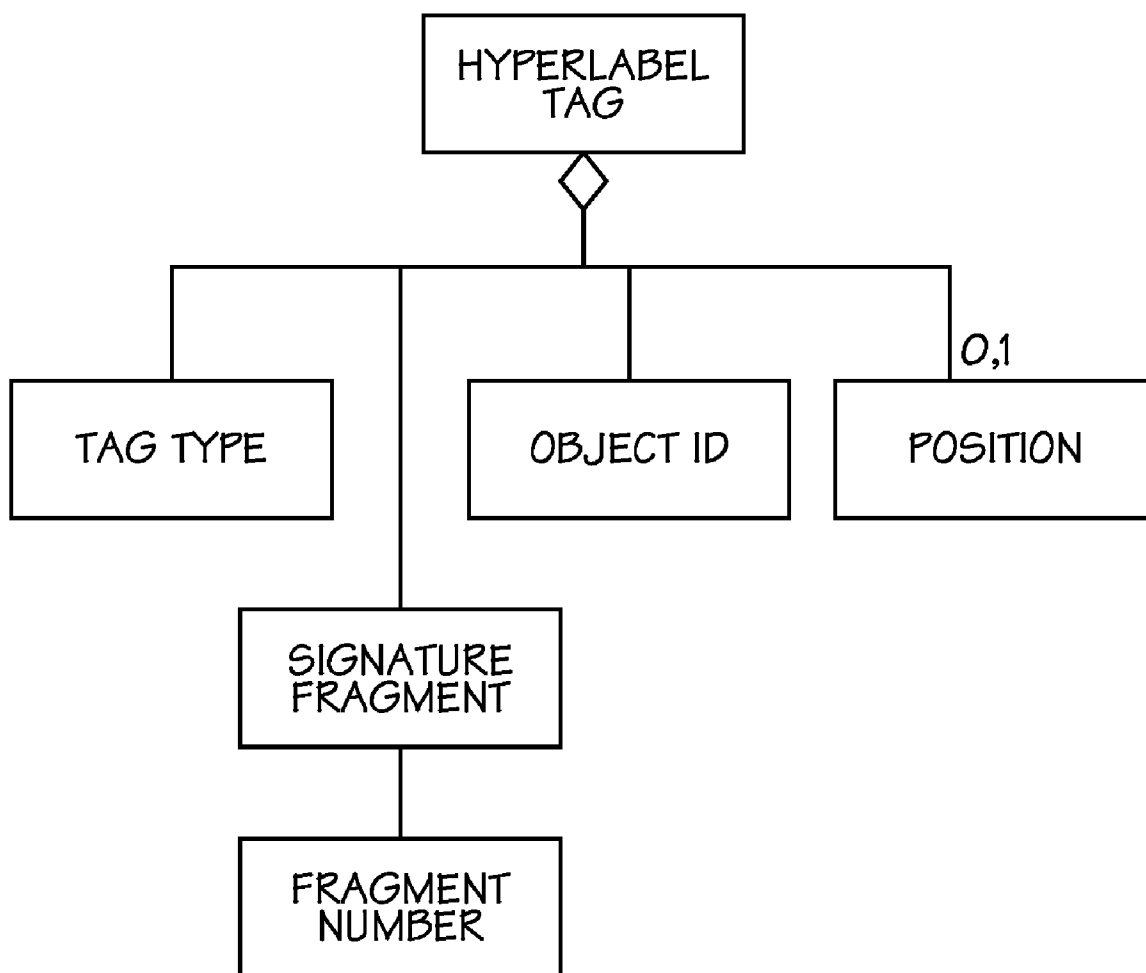

FIG. 49

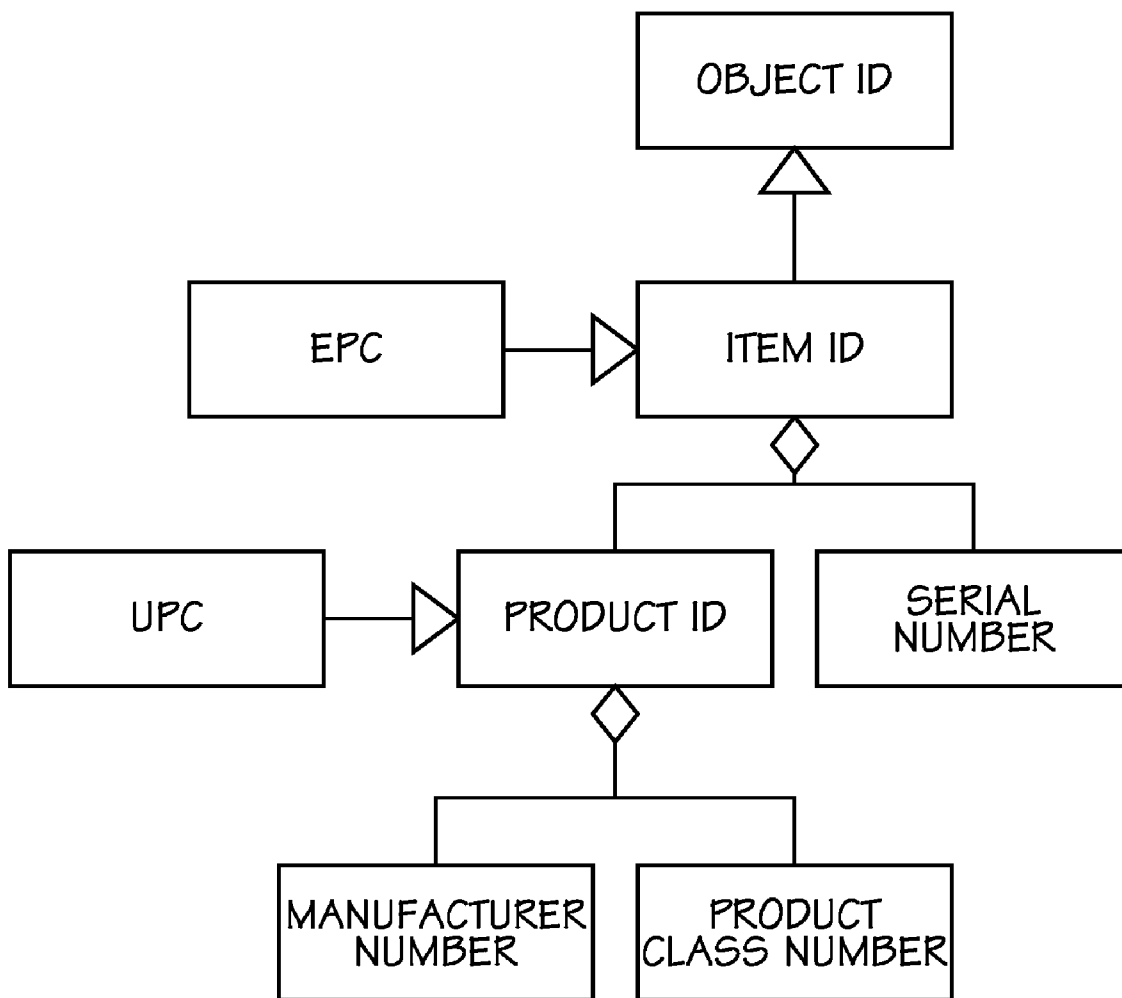

FIG. 50

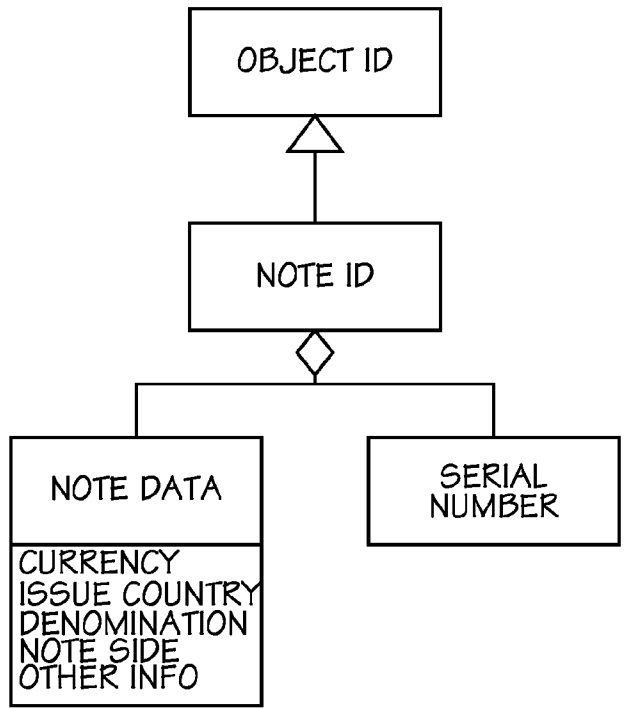

FIG. 51

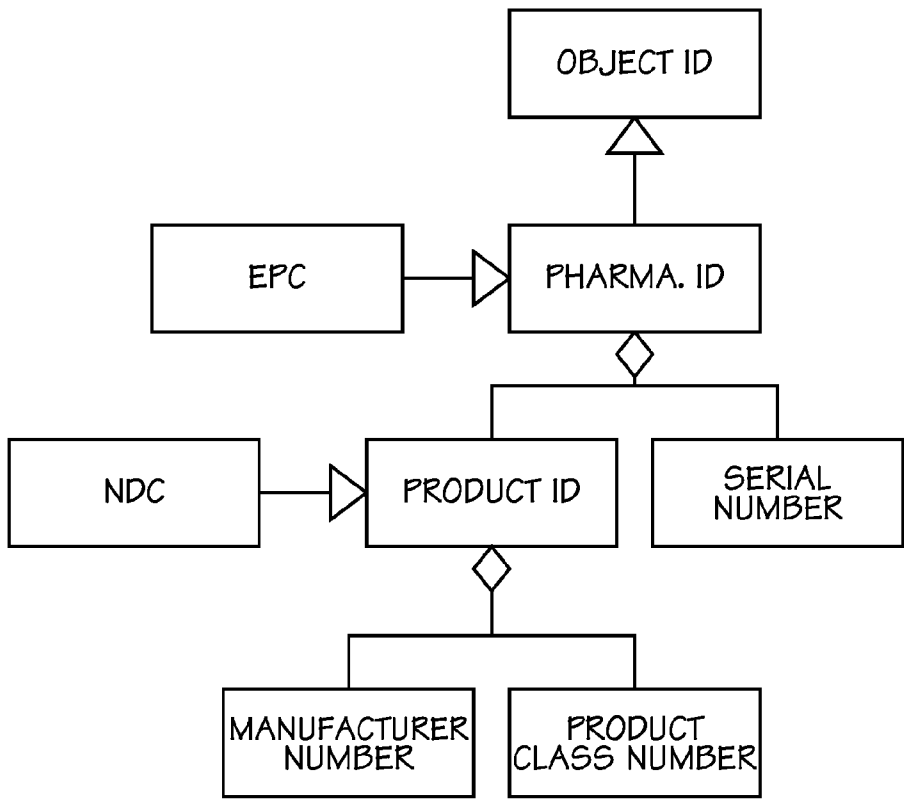

FIG. 52

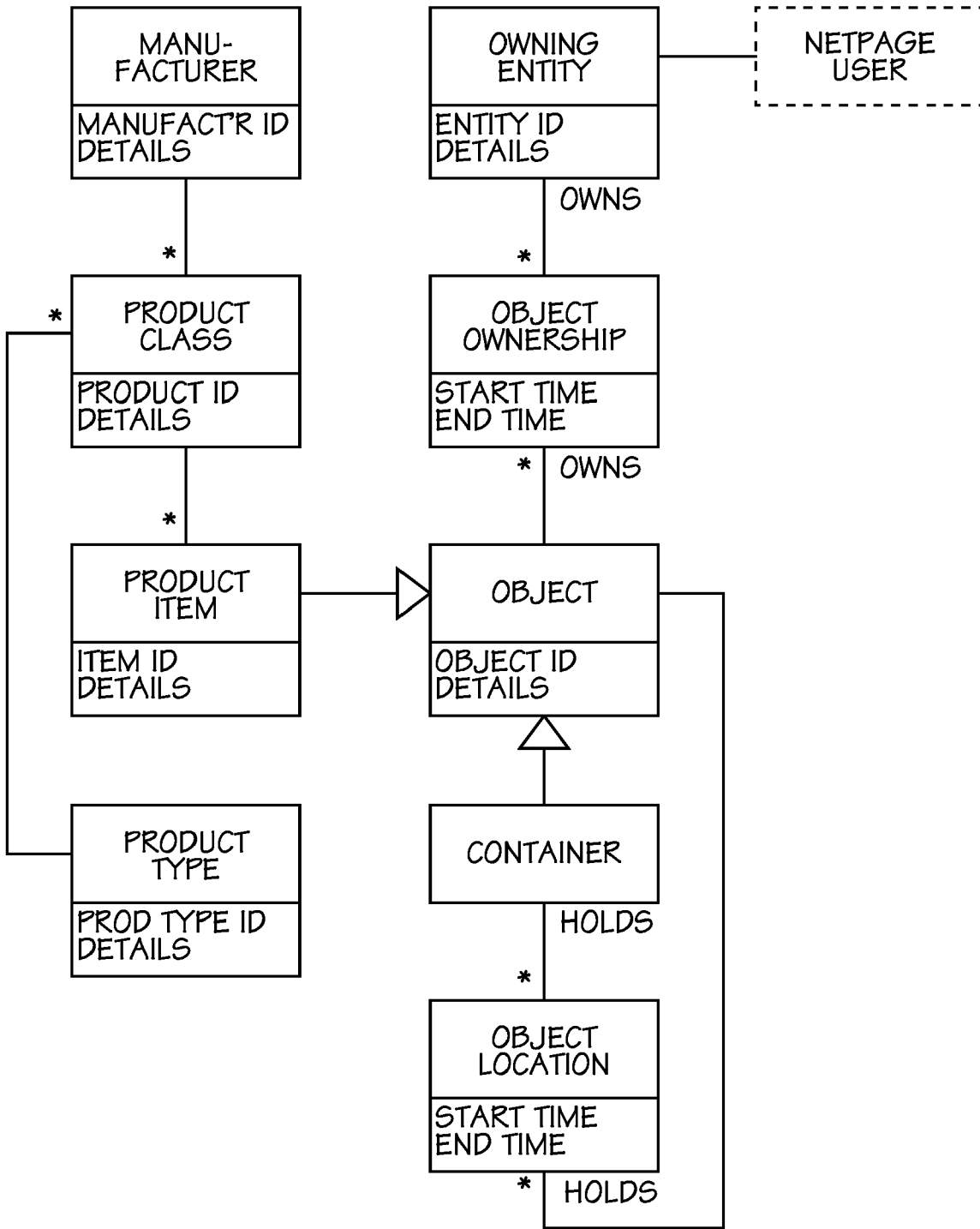

FIG. 53

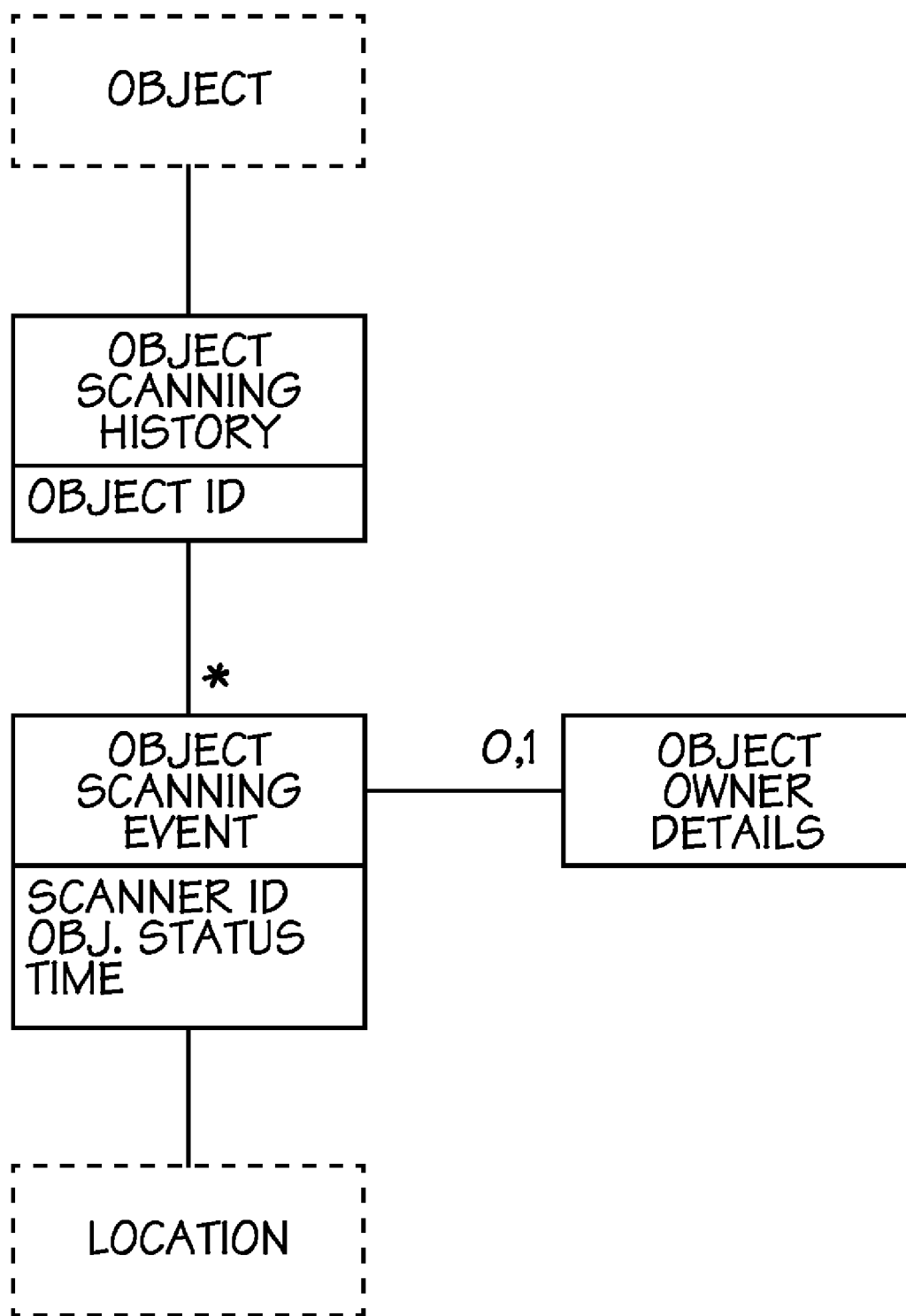

FIG. 54

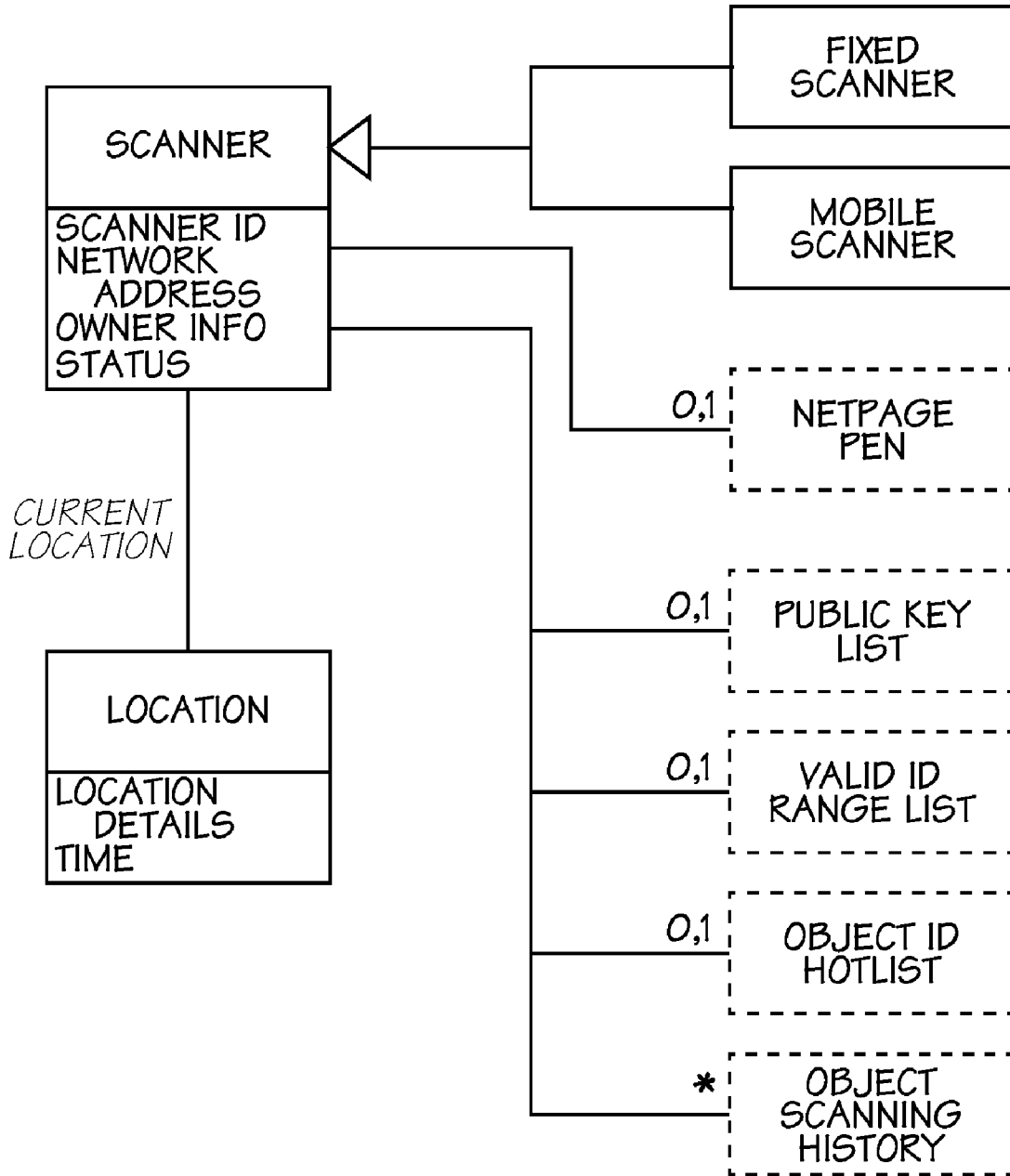

FIG. 55

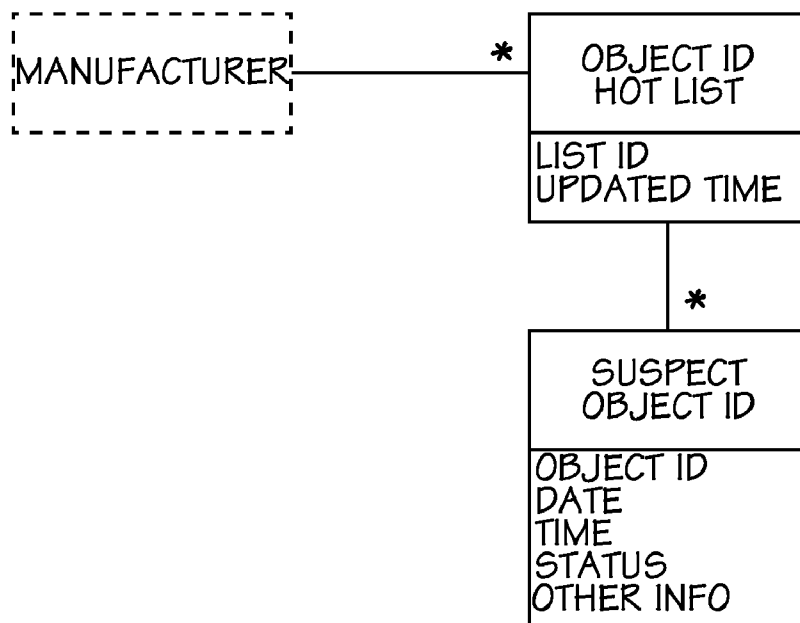

FIG. 56

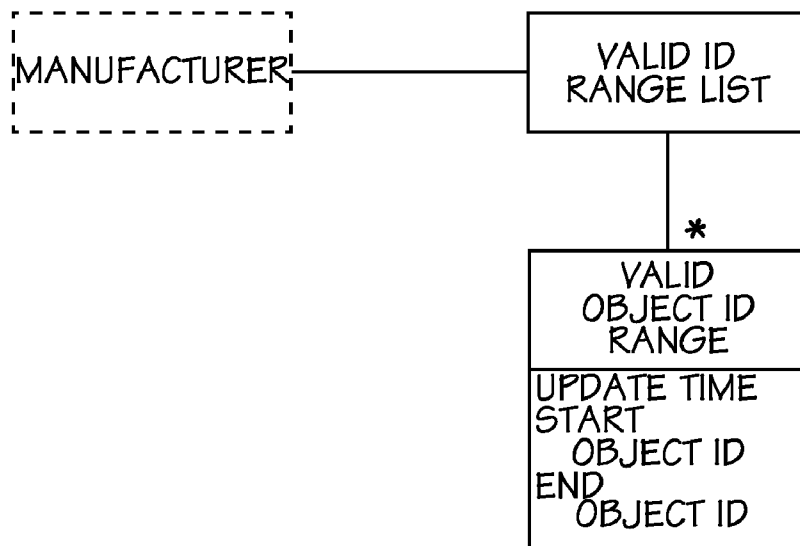

FIG. 57

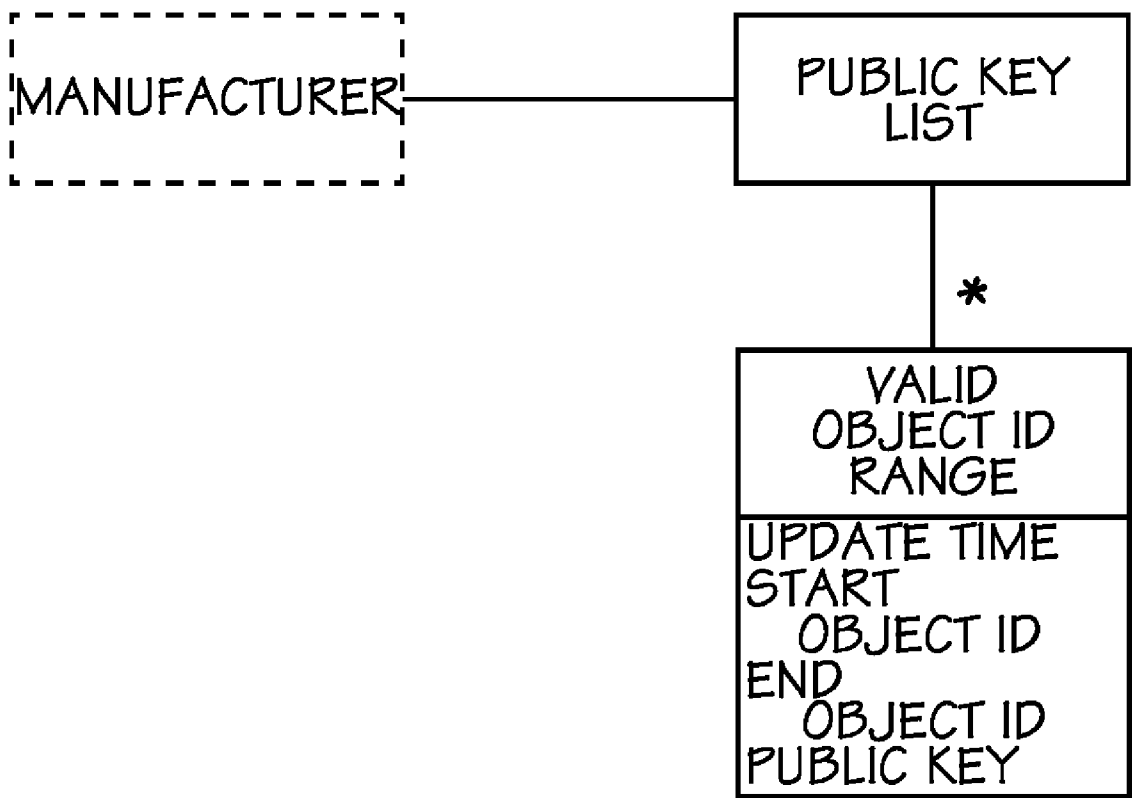

FIG. 58

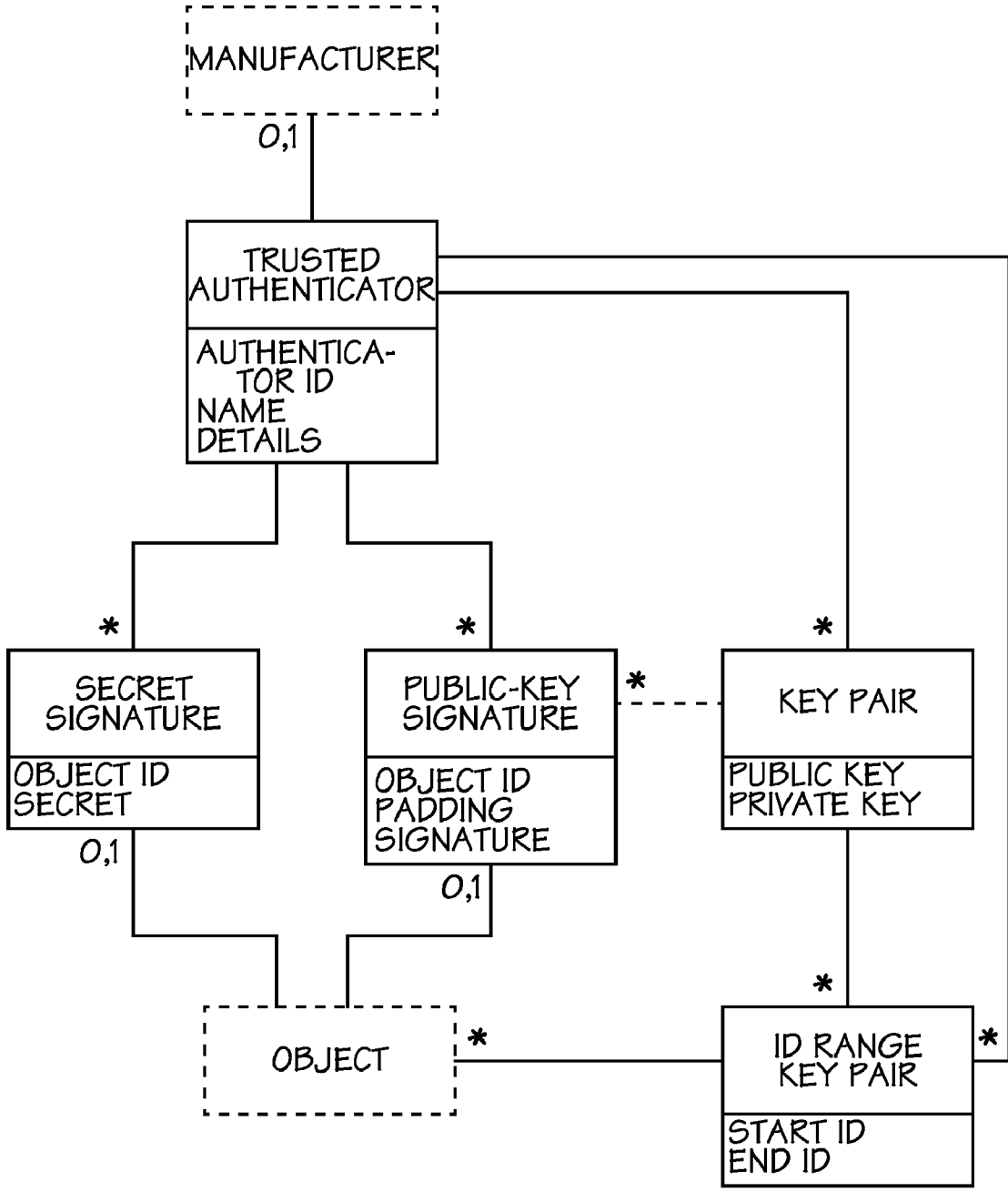

FIG. 59

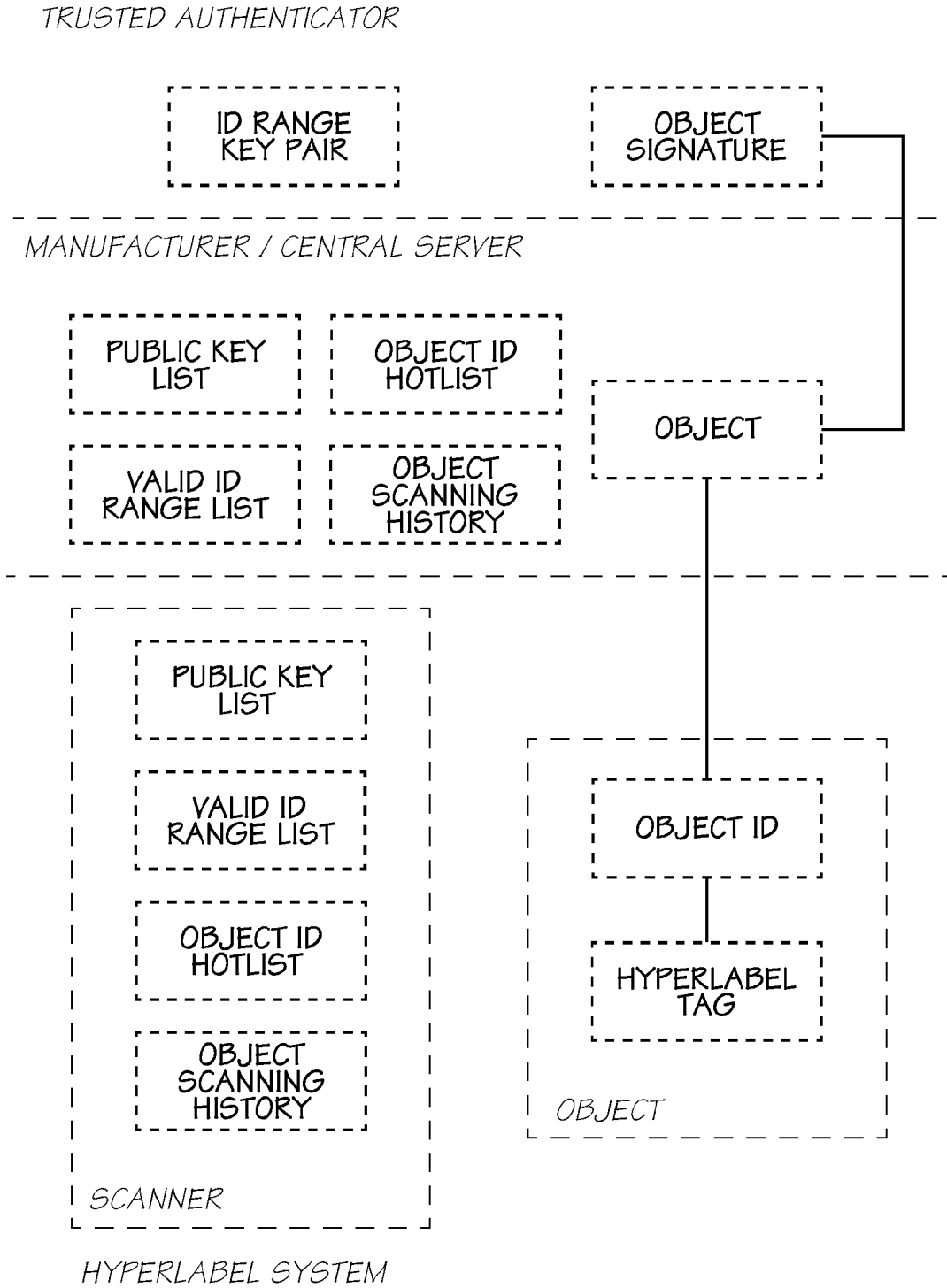

FIG. 60

**AUTHENTICATING AN OBJECT**

**CROSS REFERENCES TO RELATED APPLICATION**

**[0001]** The present application is a continuation application of U.S. application Ser. No. 11/863,267, filed on Sep. 28, 2007, which is a continuation application of U.S. application Ser. No. 11/041,648 filed on Jan. 25, 2005, the entire contents of which are herein incorporated by reference.

**FIELD OF THE INVENTION**

**[0002]** The present invention broadly relates to a method and apparatus for the protection of products and security documents using machine readable tags disposed on or in a surface of the product or security document.

**CROSS REFERENCE TO OTHER RELATED APPLICATIONS**

**[0003]** The following applications have been filed by the Applicant simultaneously with application Ser. No. 11/041,648:

11/863,253	11/863,255	11/863,257	11/863,258	11/863,268
11/863,269	11/863,270	11/863,271	11/863,273	11/863,263
11/863,264				

**[0004]** The disclosures of these co-pending applications are incorporated herein by reference

**[0005]** The following applications were filed by the Applicant simultaneously with the parent application, application Ser. No. 11/041,648:

11/041,650	11/041,651	11/041,652	7,441,712	11/041,610
11/041,609	11/041,626	11/041,627	11/041,624	7,395,963
11/041,556	11/041,580	11/041,723	11/041,648	

**[0006]** The disclosures of these co-pending applications are incorporated herein by reference.

7,249,108	6,566,858	6,331,946	6,246,970	6,442,525
7,346,586	09/505,951	6,374,354	7,246,098	6,816,968
6,757,832	6,334,190	6,745,331	7,249,109	7,197,642
7,093,139	10/636,263	10/636,283	10/866,608	7,210,038
7,401,223	10/940,653	10/942,858	10/815,621	7,243,835
10/815,630	10/815,637	10/815,638	7,251,050	10/815,642
7,097,094	7,137,549	10/815,618	7,156,292	10/815,635
7,357,323	10/815,634	7,137,566	7,131,596	7,128,265
7,197,374	7,175,089	10/815,617	10/815,620	7,178,719
10/815,613	7,207,483	7,296,737	7,270,266	10/815,614
10/815,636	7,128,720	10/815,609	7,150,398	7,159,777
7,450,273	7,188,769	7,097,106	7,070,110	7,243,849
6,623,101	6,406,129	6,505,916	6,457,809	6,550,895
6,457,812	6,428,133	7,204,941	7,282,164	10/815,628
7,416,280	6,746,105	7,246,886	7,128,400	7,108,355
6,991,322	7,287,836	7,118,197	10/728,784	7,364,269
7,077,493	6,962,402	10/728,803	7,147,308	10/728,779
7,118,198	7,168,790	7,172,270	7,229,155	6,830,318
7,195,342	7,175,261	10/773,183	7,108,356	7,118,202
10/773,186	7,134,744	10/773,185	7,134,743	7,182,439
7,210,768	10/773,187	7,134,745	7,156,484	7,118,201
7,111,926	7,431,433	10/944,043	7,156,289	7,178,718
7,225,979	09/575,197	7,079,712	6,825,945	7,330,974

-continued

6,813,039	7,190,474	6,987,506	6,824,044	7,038,797
6,980,318	6,816,274	7,102,772	7,350,236	6,681,045
6,678,499	6,679,420	6,963,845	6,976,220	6,728,000
7,110,126	7,173,722	6,976,035	6,813,558	6,766,942
6,965,454	6,995,859	7,088,459	6,720,985	7,286,113
6,922,779	6,978,019	6,847,883	7,131,058	7,295,839
7,406,445	09/693,690	6,959,298	6,973,450	7,150,404
6,965,882	7,233,924	09/575,181	09/722,174	7,175,079
7,162,259	6,718,061	10/291,523	10/291,471	7,012,710
6,825,956	7,451,115	7,222,098	10/291,825	7,263,508
7,031,010	6,972,864	6,862,105	7,009,738	6,989,911
6,982,807	10/291,576	6,829,387	6,714,678	6,644,545
6,609,653	6,651,879	10/291,555	7,293,240	10/291,592
7,415,668	7,044,363	7,004,390	6,867,880	7,034,953
6,987,581	7,216,224	10/291,821	7,162,269	7,162,222
7,290,210	7,293,233	7,293,234	6,850,931	6,865,570
6,847,961	10/685,523	10/685,583	7,162,442	10/685,584
7,159,784	10/804,034	7,404,144	6,889,896	10/831,232
7,174,056	6,996,274	7,162,088	7,388,985	7,417,759
7,362,463	7,259,884	7,167,270	7,388,685	6,986,459
10/954,170	7,181,448	10/981,626	10/981,616	7,324,989
7,231,293	7,174,329	7,369,261	7,295,922	7,200,591
11/020,106	11/020,260	11/020,321	11/020,319	11/026,045
7,068,382	7,007,851	6,957,921	6,457,883	7,044,381
7,094,910	7,091,344	7,122,685	7,038,066	7,099,019
7,062,651	6,789,194	6,789,191	10/900,129	7,278,018
7,360,089	10/982,975	10/983,029	6,644,642	6,502,614
6,622,999	6,669,385	6,827,116	7,011,128	7,416,009
6,549,935	6,987,573	6,727,996	6,591,884	6,439,706
6,760,119	7,295,332	7,064,851	6,826,547	6,290,349
6,428,155	6,785,016	6,831,682	6,741,871	6,927,871
6,980,306	6,965,439	6,840,606	7,036,918	6,977,746
6,970,264	7,068,389	7,093,991	7,190,491	10/901,154
10/932,044	10/962,412	7,177,054	7,364,282	10/965,733
10/965,933	10/974,742	10/982,974	7,180,609	10/986,375
6,982,798	6,870,966	6,822,639	6,474,888	6,627,870
6,724,374	6,788,982	7,263,270	6,788,293	6,946,672
6,737,591	7,091,960	7,369,265	6,792,165	7,105,753
6,795,593	6,980,704	6,768,821	7,132,612	7,041,916
6,797,895	7,015,901	7,289,882	7,148,644	10/778,056
10/778,058	10/778,060	10/778,059	10/778,063	10/778,062
10/778,061	10/778,057	7,096,199	7,286,887	7,400,937
10/917,466	7,324,859	7,218,978	7,245,294	7,277,085
7,187,370	10/917,436	10/943,856	10/919,379	7,019,319
10/943,878	10/943,849	7,043,096	7,055,739	7,233,320
6,830,196	6,832,717	7,182,247	7,120,853	7,082,562
6,843,420	10/291,718	6,789,731	7,057,608	6,766,944
6,766,945	7,289,103	7,412,651	7,299,969	10/409,864
7,108,192	7,111,791	7,077,333	6,983,878	10/786,631
7,134,598	7,431,219	6,929,186	6,994,264	7,017,826
7,014,123	7,134,601	7,150,396	10/971,146	7,017,823
7,025,276	10/492,169	10/492,152	7,359,551	7,444,021
7,308,148	10/502,575	10/683,040	10/510,391	10/510,392
10/778,090	6,957,768	09/575,172	7,170,499	7,106,888
7,123,239	6,982,701	6,982,703	7,227,527	6,786,397
6,947,027	6,975,299	7,139,431	7,048,178	7,118,025
6,839,053	7,015,900	7,010,147	7,133,557	6,914,593
7,437,671	6,938,826	7,278,566	7,123,245	6,992,662
6,593,166	7,132,679	6,940,088	10/727,181	10/727,162
7,377,608	7,399,043	7,121,639	7,165,824	7,152,942
10/727,157	7,181,572	7,096,137	7,302,592	7,278,034
7,188,282	10/727,159	10/727,180	10/727,179	10/727,192
10/727,274	10/727,164	10/727,161	10/727,198	10/727,158
10/754,536	10/754,938	10/727,160	10/934,720	7,369,270
6,795,215	7,070,098	7,154,638	6,805,419	6,859,289
6,977,751	6,398,332	6,394,573	6,622,923	6,747,760
6,921,144	10/884,881	7,092,112	7,192,106	7,374,266
7,427,117	7,448,707	7,281,330	10/854,503	7,328,956
10/854,509	7,188,928	7,093,989	7,377,609	10/854,495
10/854,498	10/854,511	7,390,071	10/854,525	10/854,526
10/854,516	7,252,353	10/854,515	7,267,417	10/854,505
10/854,493	7,275,805	7,314,261	10/854,490	7,281,777
7,290,852	10/854,528	10/854,523	10/854,527	10/854,524
10/854,520	10/854,514	10/854,519	10/854,517	10/854,499
10/854,501	7,266,661	7,243,193	10/854,518	10/854,517
10/934,628	6,454,482	6,808,330	6,527,365	6,474,773

-continued

6,550,997	7,093,923	6,957,923	7,131,724	7,396,177
7,168,867	7,125,098	7,195,336		

[0007] Various methods, systems and apparatus relating to the present invention are disclosed in the following co-pending applications and granted patents filed by the applicant or assignee of the present invention. The disclosures of all of these co-pending applications and granted patents are incorporated herein by cross-reference.

BACKGROUND

[0008] Currently there are two main types of technologies offering alternative methods of unique product item identification, such as EPCs, namely:

- [0009] 2D optical barcodes, and
- [0010] RFID.

[0011] A 2D optical barcode consists of a composite image that can store about 2,000 bytes of data along two dimensions. The Uniform Code Council and European Article Numbering (EAN) International have standardized a range of 2D barcodes, all with a significantly larger data capacity than the existing EPC.

[0012] 2D optical barcodes are now widely used in the global pharmaceutical industry. In the United States, the Food and Drug Administration (FDA) has mandated their use on all pharmaceutical goods manufactured within its jurisdiction to identify product lines. The main advantage driving their acceptance is that they are inexpensive to produce.

[0013] The main disadvantage of 2D optical barcodes is that they are often difficult to read due to label damage and a direct 'line-of-sight' is needed for scanning. In addition to this, 2-D optical barcodes are unsightly and therefore detrimental to the packaging of the product. This problem is exacerbated in the case of pharmaceuticals, which generally use small packaging, but require a relatively large bar-code which can therefore obscure a substantial part of the packaging.

[0014] In the case RFID tags, these can again provide unique product item identification encoded in the form of an EPC. However, there are also some disadvantages that make RFID tags unsuitable for some products.

[0015] First, RFID tags are costly to produce. Secondly, the presence of metals, liquids and other electromagnetic frequency (EMF) signals can interfere with RFID tag scanners, and thus seriously jeopardize the reliability and integrity of the RFID system. Thirdly tags can be read remotely without knowledge of the tag holder, thereby raising privacy concerns.

Surface Coding Background

[0016] The netpage surface coding consists of a dense planar tiling of tags. Each tag encodes its own location in the plane. Each tag also encodes, in conjunction with adjacent tags, an identifier of the region containing the tag. This region ID is unique among all regions. In the netpage system the region typically corresponds to the entire extent of the tagged surface, such as one side of a sheet of paper.

[0017] The surface coding is designed so that an acquisition field of view large enough to guarantee acquisition of an entire tag is large enough to guarantee acquisition of the ID of the region containing the tag. Acquisition of the tag itself guarantees acquisition of the tag's two-dimensional position

within the region, as well as other tag-specific data. The surface coding therefore allows a sensing device to acquire a region ID and a tag position during a purely local interaction with a coded surface, e.g. during a "click" or tap on a coded surface with a pen.

[0018] The use of netpage surface coding is described in more detail in the following copending patent applications, U.S. Ser. No. 10/815,647 (docket number HYG001US), entitled "Obtaining Product Assistance" filed on 2 Apr. 2004; and U.S. Ser. No. 10/815,609 (docket number HYT001US), entitled "Laser Scanner Device for Printed Product Identification Cod" filed on 2 Apr. 2004.

Cryptography Background

[0019] Cryptography is used to protect sensitive information, both in storage and in transit, and to authenticate parties to a transaction. There are two classes of cryptography in widespread use: secret-key cryptography and public-key cryptography.

[0020] Secret-key cryptography, also referred to as symmetric cryptography, uses the same key to encrypt and decrypt a message. Two parties wishing to exchange messages must first arrange to securely exchange the secret key.

[0021] Public-key cryptography, also referred to as asymmetric cryptography, uses two encryption keys. The two keys are mathematically related in such a way that any message encrypted using one key can only be decrypted using the other key. One of these keys is then published, while the other is kept private. They are referred to as the public and private key respectively. The public key is used to encrypt any message intended for the holder of the private key. Once encrypted using the public key, a message can only be decrypted using the private key. Thus two parties can securely exchange messages without first having to exchange a secret key. To ensure that the private key is secure, it is normal for the holder of the private key to generate the public-private key pair.

[0022] Public-key cryptography can be used to create a digital signature. If the holder of the private key creates a known hash of a message and then encrypts the hash using the private key, then anyone can verify that the encrypted hash constitutes the "signature" of the holder of the private key with respect to that particular message, simply by decrypting the encrypted hash using the public key and verifying the hash against the message. If the signature is appended to the message, then the recipient of the message can verify both that the message is genuine and that it has not been altered in transit.

[0023] Secret-key can also be used to create a digital signature, but has the disadvantage that signature verification can also be performed by a party privy to the secret key.

[0024] To make public-key cryptography work, there has to be a way to distribute public keys which prevents impersonation. This is normally done using certificates and certificate authorities. A certificate authority is a trusted third party which authenticates the association between a public key and a person's or other entity's identity. The certificate authority verifies the identity by examining identity documents etc., and then creates and signs a digital certificate containing the identity details and public key. Anyone who trusts the certificate authority can use the public key in the certificate with a high degree of certainty that it is genuine. They just have to verify that the certificate has indeed been signed by the certificate authority, whose public key is well-known.

[0025] To achieve comparable security to secret-key cryptography, public-key cryptography utilises key lengths an order of magnitude larger, i.e. a few thousand bits compared with a few hundred bits.

[0026] Schneier B. (*Applied Cryptography*, Second Edition, John Wiley & Sons 1996) provides a detailed discussion of cryptographic techniques.

#### SUMMARY OF THE INVENTION

[0027] According to an aspect of the present invention there is provided a method of authenticating an object, the method including steps of:

receiving indicating data, the indicating data being generated in response to sensing of a coded data portion provided on or in a surface associated with the object, the indicating data being indicative of:

[0028] an identity;

[0029] a position of the coded data portion; and

[0030] a fragment of a signature, the signature being a digital signature of at least the identity, and comprising a plurality of signature fragments;

determining from the indicating data, a received identity, a received signature fragment and the position of the coded data portion;

determining, using the position, a received signature fragment identifier;

determining, using the received identity, a determined signature;

determining, using the determined signature and the received signature fragment identifier, a determined signature fragment;

comparing the determined signature fragment to the received signature fragment; and

authenticating the object using the result of the comparison.

[0031] Other aspects are also disclosed.

#### BRIEF DESCRIPTION OF THE DRAWINGS

[0032] An example of the present invention will now be described with reference to the accompanying drawings, in which:—

[0033] FIG. 1 is an example of a document including Hyperlabel encoding;

[0034] FIG. 2 is an example of a system for interacting with the Hyperlabel document of FIG. 1;

[0035] FIG. 3 is a further example of system for interacting with the Hyperlabel document of FIG. 1;

[0036] FIG. 4 is a first example of a tag structure;

[0037] FIG. 5 is an example of a symbol unit cell for the tag structure of FIG. 4;

[0038] FIG. 6 is an example of an array of the symbol unit cells of FIG. 5;

[0039] FIG. 7 is an example of symbol bit ordering in the unit cells of FIG. 5;

[0040] FIG. 8 is an example of the tag structure of FIG. 4 with every bit set;

[0041] FIG. 9 is an example of tag types within a tag group for the tag structure of FIG. 4;

[0042] FIG. 10 is an example of continuous tiling of the tag groups of FIG. 9;

[0043] FIG. 11 is an example of interleaved codewords for the tag structure of FIG. 4;

[0044] FIG. 12 is an example of a code word for the tag structure of FIG. 4;

[0045] FIG. 13 is an example of a tag and its eight immediate neighbours, each labelled with its corresponding bit index in the active area map;

[0046] FIG. 14 is an alternative example of tag types within a tag group for the tag structure of FIG. 4;

[0047] FIG. 15 is an example of continuous tiling of the tag groups of FIG. 14;

[0048] FIG. 16 is an example of the orientation-indicating cyclic position codeword R for the tag group of FIG. 14;

[0049] FIG. 17 is an example of a local codeword A for the tag group of FIG. 14;

[0050] FIG. 18 is an example of distributed codewords B, C, D and E, for the tag group of FIG. 14;

[0051] FIG. 19 is an example of a layout of complete tag group;

[0052] FIG. 20 is an example of a code word for the tag group of FIG. 14;

[0053] FIG. 21 is a second example of a tag structure;

[0054] FIG. 22 is an example of a symbol unit cell for the tag structure of FIG. 21;

[0055] FIG. 23 is an example of an array of the symbol unit cells of FIG. 22;

[0056] FIG. 24 is an example of symbol bit ordering in the unit cells of FIG. 22;

[0057] FIG. 25 is an example of the tag structure of FIG. 21 with every bit set;

[0058] FIG. 26 is an example of tag types within a tag group for the tag structure of FIG. 21;

[0059] FIG. 27 is an example of continuous tiling of the tag groups of FIG. 26;

[0060] FIG. 28 is an example of an orientation indicating cyclic position codeword for the tag structure of FIG. 21;

[0061] FIG. 29 is an example of a codeword for the tag structure of FIG. 21;

[0062] FIG. 30 is an example of fragments of distributed codewords for the tag structure of FIG. 21;

[0063] FIG. 31 is an example of continuous tiling of the tag groups of FIG. 21;

[0064] FIG. 32 is an example of a tag segment of the tag groups of FIG. 21;

[0065] FIG. 33 is an example of inter-segment spacing for the tag groups of FIG. 21;

[0066] FIG. 34 is an example of the effect of inter-segment spacing on target position for the tag groups of FIG. 21;

[0067] FIG. 35 is an example of a code word for the tag group of FIG. 21;

[0068] FIG. 36 is an example of tag coordinates for the tag group of FIG. 21;

[0069] FIG. 37 is an example of tag and six immediate neighbour tags each labelled with its corresponding bit index in the active area map;

[0070] FIG. 38 is an example of a contiguous set of tags making up a data block;

[0071] FIG. 39 is an example of an expanded tag structure;

[0072] FIG. 40 is an example of a codeword for the tag structure of FIG. 39;

[0073] FIG. 41 is an example of fragments of distributed codewords for the tag structure of FIG. 39;

[0074] FIG. 42 is a second example of fragments of distributed codewords for the tag structure of FIG. 39;

[0075] FIG. 43 is an example of an item signature object model;

[0076] FIG. 44 is an example of Scanning at Retailer interactions;

[0077] FIG. 45. is an example of Online Scanning interaction detail;

[0078] FIG. 46. is an example of Offline Scanning interaction details;

[0079] FIG. 47. is an example of netpage Pen Scanning interactions;

[0080] FIG. 48. is an example of netpage Pen Scanning interaction details;

[0081] FIG. 49. is an example of a Hyperlabel tag class diagram;

[0082] FIG. 50. is an example of an item ID class diagram;

[0083] FIG. 51. is an example of a note ID class diagram

FIG. 52. is an example of a pharmaceutical ID class diagram;

[0084] FIG. 53. is an example of an Object Description, ownership and aggregation class diagram;

[0085] FIG. 54. is an example of an Object Scanning History class diagram;

[0086] FIG. 55. is an example of scanner class diagram;

[0087] FIG. 56. is an example of an object ID hot list diagram;

[0088] FIG. 57. is an example of a valid ID range class diagram;

[0089] FIG. 58. is an example of Public Key List class diagram;

[0090] FIG. 59. is an example of a Trusted Authenticator class diagram;

[0091] FIG. 60. is an example of Tagging and Tracking Object Management.

#### DETAILED DESCRIPTION OF THE DRAWINGS

[0092] The netpage surface coding consists of a dense planar tiling of tags. Each tag encodes its own location in the plane. Each tag also encodes, in conjunction with adjacent tags, an identifier of the region containing the tag. In the netpage system, the region typically corresponds to the entire extent of the tagged surface, such as one side of a sheet of paper.

[0093] Hyperlabel is the adaptation of the netpage tags for use in unique item identification for a wide variety of applications, including security document protection, object tracking, pharmaceutical security, supermarket automation, interactive product labels, web-browsing from printed surfaces, paper based email, and many others.

[0094] Using Memjet™ digital printing technology (which is the subject of a number of pending U.S. patent applications including U.S. Ser. No. 10/407,212), Hyperlabel tags are printed over substantially an entire surface, such as a security document, bank note, or pharmaceutical packaging, using infrared (IR) ink. By printing the tags in infrared-absorptive ink on any substrate which is infra-red-reflective, the near-infrared wavelengths, and hence the tags are invisible to the human eye but are easily sensed by a solid-state image sensor with an appropriate filter. This allows machine readable information to be encoded over a large portion of the note or other surface, with no visible effect on the original note text or graphics thereon. A scanning laser or image sensor can read the tags on any part of the surface to performs associated actions, such as validating each individual note or item.

[0095] An example of such a Hyperlabel encoded document, is shown in FIG. 1. In this example, the Hyperlabel document consists of graphic data 2 printed using visible ink, and coded data 3 formed from Hyperlabel tags 4. The document includes an interactive element 6 defined by a zone 7 which corresponds to the spatial extent of a corresponding

graphic 8. In use, the tags encode tag data including an ID. By sensing at least one tag, and determining and interpreting the encoded ID using an appropriate system, this allows the associated actions to be performed.

[0096] In one example, a tag map is used to define a layout of the tags on the Hyperlabel document based on the ID encoded within the tag data. The ID can also be used to reference a document description which describes the individual elements of the Hyperlabel document, and in particular describes the type and spatial extent (zone) of interactive elements, such as a button or text field. Thus, in this example, the element 6 has a zone 7 which corresponds to the spatial extent of a corresponding graphic 8. This allows a computer system to interpret interactions with the Hyperlabel document.

[0097] In position indicating techniques, the ID encoded within the tag data of each tag allows the exact position of the tag on the Hyperlabel document to be determined from the tag map. The position can then be used to determine whether the sensed tag is positioned in a zone of an interactive element from the document description.

[0098] In object indicating techniques, the ID encoded within the tag data allows the presence of the tag in a region of the document to be determined from the tag map (the relative position of the tag within the region may also be indicated). In this case, the document description can be used to determine whether the region corresponds to the zone of an interactive element.

[0099] An example of this process will now be described with reference to FIGS. 2 and 3 which show how a sensing device in the form of a netpage or Netpage pen 101, which interacts with the coded data on a printed Hyperlabel document 1, such as a security document, label, product packaging or the like.

[0100] The Netpage pen 101 senses a tag using an area image sensor and detects tag data. The Netpage pen 101 uses the sensed data tag to generate interaction data which is transmitted via a short-range radio link 9 to a relay 44, which may form part of a computer 75 or a printer 601. The relay sends the interaction data, via a network 19, to a document server 10, which uses the ID to access the document description, and interpret the interaction. In appropriate circumstances, the document server sends a corresponding message to an application server 13, which can then perform a corresponding action.

[0101] In an alternative embodiment, the PC, Web terminal, netpage printer or relay device may communicate directly with local or remote application software, including a local or remote Web server. Relatedly, output is not limited to being printed by the netpage printer. It can also be displayed on the PC or Web terminal, and further interaction can be screen-based rather than paper-based, or a mixture of the two.

[0102] Typically Netpage pen users register with a registration server 11, which associates the user with an identifier stored in the respective Netpage pen. By providing the sensing device identifier as part of the interaction data, this allows users to be identified, allowing transactions or the like to be performed.

[0103] Hyperlabel documents are generated by having an ID server generate an ID which is transferred to the document server 10. The document server 10 determines a document description and then records an association between the document description and the ID, to allow subsequent retrieval of the document description using the ID.

**[0104]** The ID is then used to generate the tag data, as will be described in more detail below, before the document is printed by the Hyperlabel printer **601**, using the page description and the tag map.

**[0105]** Each tag is represented by a pattern which contains two kinds of elements. The first kind of element is a target. Targets allow a tag to be located in an image of a coded surface, and allow the perspective distortion of the tag to be inferred. The second kind of element is a macrodot. Each macrodot encodes the value of a bit by its presence or absence.

**[0106]** The pattern is represented on the coded surface in such a way as to allow it to be acquired by an optical imaging system, and in particular by an optical system with a narrow-band response in the near-infrared. The pattern is typically printed onto the surface using a narrowband near-infrared ink.

**[0107]** In the Hyperlabel system the region typically corresponds to the surface of an entire product item, or to a security document, and the region ID corresponds to the unique item ID. For clarity in the following discussion we refer to items and item IDs (or simply IDs), with the understanding that the item ID corresponds to the region ID.

**[0108]** The surface coding is designed so that an acquisition field of view large enough to guarantee acquisition of an entire tag is large enough to guarantee acquisition of the ID of the region containing the tag. Acquisition of the tag itself guarantees acquisition of the tag's two-dimensional position within the region, as well as other tag-specific data. The surface coding therefore allows a sensing device to acquire a region ID and a tag position during a purely local interaction with a coded surface, e.g. during a "click" or tap on a coded surface with a pen.

**[0109]** A wide range of different tag structures can be used, and some examples will now be described.

#### FIRST EXAMPLE TAG STRUCTURE

**[0110]** FIG. 4 shows the structure of a complete tag. Each of the four black circles is a target. The tag, and the overall pattern, has four-fold rotational symmetry at the physical level.

**[0111]** Each square region represents a symbol, and each symbol represents four bits of information.

**[0112]** FIG. 5 shows the structure of a symbol. It contains four macrodots, each of which represents the value of one bit by its presence (one) or absence (zero).

**[0113]** The macrodot spacing is specified by the parameter  $s$  throughout this document. It has a nominal value of  $143\ \mu\text{m}$ , based on 9 dots printed at a pitch of 1600 dots per inch. However, it is allowed to vary by  $\pm 10\%$  according to the capabilities of the device used to produce the pattern.

**[0114]** FIG. 6 shows an array of nine adjacent symbols. The macrodot spacing is uniform both within and between symbols.

**[0115]** FIG. 7 shows the ordering of the bits within a symbol. Bit zero is the least significant within a symbol; bit three is the most significant. Note that this ordering is relative to the orientation of the symbol. The orientation of a particular symbol within the tag is indicated by the orientation of the label of the symbol in the tag diagrams. In general, the orientation of all symbols within a particular segment of the tag have the same orientation, consistent with the bottom of the symbol being closest to the centre of the tag.

**[0116]** Only the macrodots are part of the representation of a symbol in the pattern. The square outline of a symbol is used

in this document to more clearly elucidate the structure of a tag. FIG. 8, by way of illustration, shows the actual pattern of a tag with every bit set. Note that, in practice, every bit of a tag can never be set.

**[0117]** A macrodot is nominally circular with a nominal diameter of  $(5/9)s$ . However, it is allowed to vary in size by  $\pm 10\%$  according to the capabilities of the device used to produce the pattern.

**[0118]** A target is nominally circular with a nominal diameter of  $(17/9)s$ . However, it is allowed to vary in size by  $\pm 10\%$  according to the capabilities of the device used to produce the pattern.

**[0119]** The tag pattern is allowed to vary in scale by up to  $\pm 10\%$  according to the capabilities of the device used to produce the pattern. Any deviation from the nominal scale is recorded in the tag data to allow accurate generation of position samples.

**[0120]** Each symbol shown in the tag structure in FIG. 4 has a unique label. Each label consists an alphabetic prefix and a numeric suffix.

#### Tag Group

**[0121]** Tags are arranged into tag groups. Each tag group contains four tags arranged in a square. Each tag therefore has one of four possible tag types according to its location within the tag group square. The tag types are labelled **00**, **10**, **01** and **11**, as shown in FIG. 9.

**[0122]** FIG. 10 shows how tag groups are repeated in a continuous tiling of tags. The tiling guarantees the any set of four adjacent tags contains one tag of each type.

#### Codewords

**[0123]** The tag contains four complete codewords. Each codeword is of a punctured  $2^4$ -ary (8,5) Reed-Solomon code.

**[0124]** Two of the codewords are unique to the tag. These are referred to as local and are labelled A and B. The tag therefore encodes up to 40 bits of information unique to the tag.

**[0125]** The remaining two codewords are unique to a tag type, but common to all tags of the same type within a contiguous tiling of tags. These are referred to as global and are labelled C and D, subscripted by tag type. A tag group therefore encodes up to 160 bits of information common to all tag groups within a contiguous tiling of tags.

**[0126]** The layout of the four codewords is shown in FIG. 11.

#### Reed-Solomon Encoding

**[0127]** Codewords are encoded using a punctured  $2^4$ -ary (8,5) Reed-Solomon code.

**[0128]** A  $2^4$ -ary (8,5) Reed-Solomon code encodes 20 data bits (i.e. five 4-bit symbols) and 12 redundancy bits (i.e. three 4-bit symbols) in each codeword. Its error-detecting capacity is three symbols. Its error-correcting capacity is one symbol.

**[0129]** As shown in FIG. 12, codeword coordinates are indexed in coefficient order, and the data bit ordering follows the codeword bit ordering.

**[0130]** A punctured  $2^4$ -ary (8,5) Reed-Solomon code is a  $2^4$ -ary (15,5) Reed-Solomon code with seven redundancy coordinates removed. The removed coordinates are the most significant redundancy coordinates.

The code has the following primitive polynomial:

$$p(x) = x^4 + x + 1$$

[0131] The code has the following generator polynomial:

$$g(x)=(x+\alpha)(x+\alpha^2)\dots(x+\alpha^{10})$$

[0132] For a detailed description of Reed-Solomon codes, refer to Wicker, S. B. and V. K. Bhargava, eds., Reed-Solomon Codes and Their Applications, IEEE Press, 1994.

Tag Coordinate Space

[0133] The tag coordinate space has two orthogonal axes labelled x and y respectively. When the positive x axis points to the right then the positive y axis points down.

[0134] The surface coding does not specify the location of the tag coordinate space origin on a particular tagged surface, nor the orientation of the tag coordinate space with respect to the surface. This information is application-specific. For example, if the tagged surface is a sheet of paper, then the application which prints the tags onto the paper may record the actual offset and orientation, and these can be used to normalise any digital ink subsequently captured in conjunction with the surface.

[0135] The position encoded in a tag is defined in units of tags. By convention, the position is taken to be the position of the centre of the tag closest to the origin.

Tag Information Content

[0136] Table 1 defines the information fields embedded in the surface coding. Table 2 defines how these fields map to codewords.

TABLE 1

Field definitions	
Field	width description
<u>per codeword</u>	
codeword type	2 The type of the codeword, i.e. one of A (b'00'), B (b'01'), C (b'10') and D (b'11').
<u>per tag</u>	
tag type	2 The type of the tag, i.e. one of 00 (b'00'), 01 (b'01'), 10 (b'10') and 11 (b'11') - corresponds to the bottom two bits of the x and y coordinates of the tag.
x coordinate	13 The unsigned x coordinate of the tag allows a maximum coordinate value of approximately 14 m.
y coordinate	13 The unsigned y coordinate of the tag <sup>b</sup> .
active area flag	1 A flag indicating whether the tag is a member of an active area. b'1' indicates membership.
active area map flag	1 A flag indicating whether an active area map is present. b'1' indicates the presence of a map (see next field). If the map is absent then the value of each map entry is derived from the active area flag (see previous field).
active area map	8 A map <sup>1</sup> of which of the tag's immediate eight neighbours are members of an active area. b'1' indicates membership (FIG. 13 indicates the bit ordering of the map)
data fragment	8 A fragment of an embedded data stream. Only present if the active area map is absent.
<u>per tag group</u>	
encoding format	8 The format of the encoding. 0: the present encoding Other values are TBA.
Region flags	8 Flags controlling the interpretation and routing of region-related information. 0: region ID is an EPC 1: region is linked

TABLE 1-continued

Field definitions	
Field	width description
	2: region is interactive 3: region is signed 4: region includes data 5: region relates to mobile application Other bits are reserved and must be zero.
tag size adjustment	16 The difference between the actual tag size and the nominal tag size (1.7145 mm (based on 1600dpi, 9 dots per macrodot, and 12 macrodots per tag)), in 10 nm units, in sign-magnitude format.
Region ID	96 The ID of the region containing the tags.
CRC	16 A CRC of tag group data (CCITT CRC-16 (ITU, Interface between Data Terminal Equipment (DTE) and Data Circuit-terminating Equipment (DCE) for terminals operating in the packet mode and connected to public data networks by dedicated circuit, ITU-T X.25 (10/96))
Total	320

[0137] The active area map indicates whether the corresponding tags are members of an active area. An active area is an area within which any captured input should be immediately forwarded to the corresponding Hyperlabel server for interpretation. It also allows the Hyperlabel sensing device to signal to the user that the input will have an immediate effect.

TABLE 2

Mapping of fields to codewords				
codeword	codeword bits	field	Width	field bits
A	1:0	codeword type (b'00')	2	all
	10:2	x coordinate	9	12:4
	19:11	Y coordinate	9	12:4
B	1:0	codeword type (b'01')	2	all
	2	tag type	1	0
	5:2	x coordinate	4	3:0
	6	tag type	1	1
	9:6	y coordinate	4	3:0
	10	active area flag	1	all
C <sub>00</sub>	11	active area map flag	1	all
	19:12	active area map	8	all
	19:12	data fragment	8	all
	1:0	codeword type (b'10')	2	all
	9:2	encoding format	8	all
C <sub>01</sub>	17:10	region flags	8	all
	19:18	tag size adjustment	2	1:0
	1:0	codeword type (b'10')	2	all
C <sub>10</sub>	15:2	tag size adjustment	14	15:2
	19:16	region ID	4	3:0
C <sub>11</sub>	1:0	codeword type (b'10')	2	all
	19:2	region ID	18	21:4
D <sub>00</sub>	1:0	codeword type (b'11')	2	all
	19:2	region ID	18	57:40
D <sub>01</sub>	1:0	codeword type (b'11')	2	all
	19:2	region ID	18	75:58

TABLE 2-continued

Mapping of fields to codewords				
codeword	codeword bits	field	Width	field bits
D <sub>10</sub>	1:0	codeword type (b'11')	2	all
D <sub>11</sub>	19:2	region ID	18	93:76
	1:0	codeword type (b'11')	2	all
	3:2	region ID	2	95:94
	19:4	CRC	16	all

Note that the tag type can be moved into a global codeword to maximise local codeword utilization. This in turn can allow larger coordinates and/or 16-bit data fragments (potentially configurably in conjunction with coordinate precision). However, this reduces the independence of position decoding from region ID decoding and has not been included in the specification at this time.

Embedded Data

[0138] If the “region includes data” flag in the region flags is set then the surface coding contains embedded data. The data is encoded in multiple contiguous tags’ data fragments, and is replicated in the surface coding as many times as it will fit.

[0139] The embedded data is encoded in such a way that a random and partial scan of the surface coding containing the embedded data can be sufficient to retrieve the entire data. The scanning system reassembles the data from retrieved fragments, and reports to the user when sufficient fragments have been retrieved without error.

[0140] As shown in Table 3, a 200-bit data block encodes 160 bits of data. The block data is encoded in the data fragments of A contiguous group of 25 tags arranged in a 5x5 square. A tag belongs to a block whose integer coordinate is the tag’s coordinate divided by 5. Within each block the data is arranged into tags with increasing x coordinate within increasing y coordinate.

[0141] A data fragment may be missing from a block where an active area map is present. However, the missing data fragment is likely to be recoverable from another copy of the block.

[0142] Data of arbitrary size is encoded into a superblock consisting of a contiguous set of blocks arranged in a rectangle. The size of the superblock is encoded in each block. A block belongs to a superblock whose integer coordinate is the block’s coordinate divided by the superblock size. Within each superblock the data is arranged into blocks with increasing x coordinate within increasing y coordinate.

[0143] The superblock is replicated in the surface coding as many times as it will fit, including partially along the edges of the surface coding.

[0144] The data encoded in the superblock may include more precise type information, more precise size information, and more extensive error detection and/or correction data.

TABLE 3

Embedded data block		
field	width	description
data type	8	The type of the data in the superblock. Values include: 0: type is controlled by region flags 1: MIME Other values are TBA.
superblock width	8	The width of the superblock, in blocks.
superblock height	8	The height of the superblock, in blocks.
data	160	The block data.
CRC	16	A CRC of the block data.
total	200	

ALTERNATIVE FIRST EXAMPLE TAG STRUCTURE

Tag Group

[0145] Tags are arranged into tag groups. Each tag group contains four tags arranged in a square. Each tag therefore has one of four possible tag types according to its location within the tag group square. The tag types are labelled **00**, **10**, **01** and **11**, as shown in FIG. 14.

[0146] Each tag in the tag group is rotated as shown in the figure, i.e. tag type **00** is rotated 0 degrees, tag type **10** is rotated 90 degrees, tag type **11** is rotated 180 degrees, and tag type **01** is rotated 270 degrees.

[0147] FIG. 15 shows how tag groups are repeated in a continuous tiling of tags. The tiling guarantees the any set of four adjacent tags contains one tag of each type.

Orientation-Indicating Cyclic Position Code

[0148] The tag contains a 2<sup>4</sup>-ary (4, 1) cyclic position code-word which can be decoded at any of the four possible orientations of the tag to determine the actual orientation of the tag. Symbols which are part of the cyclic position codeword have a prefix of “R” and are numbered 0 to 3 in order of increasing significance.

[0149] The cyclic position codeword is (0, 7, 9, E<sub>16</sub>) Note that it only uses four distinct symbol values, even though a four-bit symbol has sixteen possible values. During decoding, any unused symbol value should, if detected, be treated as an erasure. To maximise the probability of low-weight bit error patterns causing erasures rather than symbol errors, the symbol values are chosen to be as evenly spaced on the hypercube as possible.

[0150] The minimum distance of the cyclic position code is 4, hence its error-correcting capacity is one symbol in the presence of up to one erasure, and no symbols in the presence of two or more erasures.

[0151] The layout of the orientation-indicating cyclic position codeword is shown in FIG. 16.

Local Codeword

[0152] The tag locally contains one complete codeword which is used to encode information unique to the tag. The codeword is of a punctured 2<sup>4</sup>-ary (13, 7) Reed-Solomon code. The tag therefore encodes up to 28 bits of information unique to the tag.

[0153] The layout of the local codeword is shown in FIG. 17.

Distributed Codewords

[0154] The tag also contains fragments of four codewords which are distributed across the four adjacent tags in a tag group and which are used to encode information common to a set of contiguous tags. Each codeword is of a 2<sup>4</sup>-ary (15,11) Reed-Solomon code. Any four adjacent tags therefore together encode up to 176 bits of information common to a set of contiguous tags.

[0155] The layout of the four complete codewords, distributed across the four adjacent tags in a tag group, is shown in FIG. 18. The order of the four tags in the tag group in FIG. 18 is the order of the four tags in FIG. 14.

[0156] FIG. 19 shows the layout of a complete tag group.

Reed-Solomon Encoding—Local Codeword

[0157] The local codeword is encoded using a punctured 2<sup>4</sup>-ary (13, 7) Reed-Solomon code. The code encodes 28 data bits (i.e. seven symbols) and 24 redundancy bits (i.e. six symbols) in each codeword. Its error-detecting capacity is six symbols. Its error-correcting capacity is three symbols.

[0158] As shown in FIG. 20, codeword coordinates are indexed in coefficient order, and the data bit ordering follows the codeword bit ordering.

[0159] The code is a 2<sup>4</sup>-ary (15, 7) Reed-Solomon code with two redundancy coordinates removed. The removed coordinates are the most significant redundancy coordinates. The code has the following primitive polynomial:

$$p(x)=x^4+x+1 \tag{EQ 1}$$

[0160] The code has the following generator polynomial:

$$g(x)=(x+\alpha)(x+\alpha^2) \dots (x+\alpha^8) \tag{EQ 2}$$

Reed-Solomon Encoding—Distributed Codewords

[0161] The distributed codewords are encoded using a 2<sup>4</sup>-ary (15, 11) Reed-Solomon code. The code encodes 44 data bits (i.e. eleven symbols) and 16 redundancy bits (i.e. four symbols) in each codeword. Its error-detecting capacity is four symbols. Its error-correcting capacity is two symbols.

[0162] Codeword coordinates are indexed in coefficient order, and the data bit ordering follows the codeword bit ordering.

[0163] The code has the same primitive polynomial as the local codeword code.

[0164] The code has the following generator polynomial:

$$g(x)=(x+\alpha)(x+\alpha^2) \dots (x+\alpha^4) \tag{EQ 3}$$

Tag Coordinate Space

[0165] The tag coordinate space has two orthogonal axes labelled x and y respectively. When the positive x axis points to the right then the positive y axis points down.

[0166] The surface coding does not specify the location of the tag coordinate space origin on a particular tagged surface, nor the orientation of the tag coordinate space with respect to the surface. This information is application-specific. For example, if the tagged surface is a sheet of paper, then the application which prints the tags onto the paper may record

the actual offset and orientation, and these can be used to normalise any digital ink subsequently captured in conjunction with the surface.

[0167] The position encoded in a tag is defined in units of tags. By convention, the position is taken to be the position of the centre of the target closest to the origin.

Tag Information Content

FIELD DEFINITIONS

[0168] Table 4 defines the information fields embedded in the surface coding. Table 5 defines how these fields map to codewords.

TABLE 4

Field definitions		
field	width (bits)	description
<u>per tag</u>		
x coordinate	9 or 13	The unsigned x coordinate of the tag allows maximum coordinate values of approximately 0.9 m and 14 m respectively.
y coordinate	9 or 13	The unsigned y coordinate of the tag allows maximum coordinate values of approximately 0.9 m and 14 m respectively
active area flag	1	A flag indicating whether the area (the diameter of the area, centered on the tag, is nominally 5 times the diagonal size of the tag) immediately surrounding the tag intersects an active area. b'1' indicates intersection.
data fragment flag	1	A flag indicating whether a data fragment is present (see next field). b'1' indicates the presence of a data fragment. If the data fragment is present then the width of the x and y coordinate fields is 9. If it is absent then the width is 13.
data fragment per tag group (i.e. per region)	0 or 8	A fragment of an embedded data stream.
encoding format	8	The format of the encoding 0: the present encoding Other values are reserved.
region flags	8	Flags controlling the interpretation of region data. 0: region ID is an EPC 1: region has signature 2: region has embedded data 3: embedded data is signature Other bits are reserved and must be zero.
tag size ID	8	The ID of the tag size. 0: the present tag size the nominal tag size is 1.7145 mm, based on 1600 dpi, 9 dots per macrodot, and 12 macrodots per tag Other values are reserved.
region ID	96	The ID of the region containing the tags.
signature	36	The signature of the region.
high-order coordinate width (w)	4	The width of the high-order part of the x and y coordinates of the tag.
high-order x coordinate	0 to 15	High-order part of the x coordinate of the tag expands the maximum coordinate values to approximately 2.4 km and 38 km respectively
high-order y coordinate	0 to 15	High-order part of the y coordinate of the tag expands the maximum coordinate values to approximately 2.4 km and 38 km respectively.
CRC	16	A CRC of tag group data.

[0169] An active area is an area within which any captured input should be immediately forwarded to the corresponding

Hyperlabel server for interpretation. This also allows the Hyperlabel server to signal to the user that the input has had an immediate effect. Since the server has access to precise region definitions, any active area indication in the surface coding can be imprecise so long as it is inclusive.

[0170] The width of the high-order coordinate fields, if non-zero, reduces the width of the signature field by a corresponding number of bits. Full coordinates are computed by prepending each high-order coordinate field to its corresponding coordinate field.

TABLE 5

Mapping of fields to codewords				
codeword	codeword bits	field	width	field bits
A	12:0	x coordinate	13	all
	12:9	data fragment	4	3:0
	25:13	y coordinate	13	all
	25:22	data fragment	4	7:4
	26	active area flag	1	all
B	27	data fragment flag	1	all
	7:0	encoding format	8	all
	15:8	region flags	8	all
	23:16	tag size ID	8	all
	39:24	CRC	16	all
C	43:40	high-order coordinate width (w)	4	3:0
	35:0	signature	36	all
	(35 - w):(36 - 2w)	high-order x coordinate	w	all
	35:(36 - w)	high-order y coordinate	w	all
D	43:36	region ID	8	7:0
	43:0	region ID	44	51:8
E	43:0	region ID	44	95:52

Embedded Data

[0171] If the “region has embedded data” flag in the region flags is set then the surface coding contains embedded data. The data is encoded in multiple contiguous tags’ data fragments, and is replicated in the surface coding as many times as it will fit.

[0172] The embedded data is encoded in such a way that a random and partial scan of the surface coding containing the embedded data can be sufficient to retrieve the entire data. The scanning system reassembles the data from retrieved fragments, and reports to the user when sufficient fragments have been retrieved without error.

[0173] As shown in Table 6, a 200-bit data block encodes 160 bits of data. The block data is encoded in the data fragments of a contiguous group of 25 tags arranged in a 5x5 square. A tag belongs to a block whose integer coordinate is the tag’s coordinate divided by 5. Within each block the data is arranged into tags with increasing x coordinate within increasing y coordinate.

[0174] A data fragment may be missing from a block where an active area map is present. However, the missing data fragment is likely to be recoverable from another copy of the block.

[0175] Data of arbitrary size is encoded into a superblock consisting of a contiguous set of blocks arranged in a rectangle. The size of the superblock is encoded in each block. A block belongs to a superblock whose integer coordinate is the block’s coordinate divided by the superblock size. Within

each superblock the data is arranged into blocks with increasing x coordinate within increasing y coordinate.

[0176] The superblock is replicated in the surface coding as many times as it will fit, including partially along the edges of the surface coding.

[0177] The data encoded in the superblock may include more precise type information, more precise size information, and more extensive error detection and/or correction data.

TABLE 6

Embedded data block		
field	width	description
data type	8	The type of the data in the superblock. Values include: 0: type is controlled by region flags 1: MIME Other values are TBA.
superblock width	8	The width of the superblock, in blocks.
superblock height	8	The height of the superblock, in blocks.
data	160	The block data.
CRC	16	A CRC of the block data.
total	200	

[0178] It will be appreciated that any form of embedded data may be used, including for example, text, image, audio, video data, such as product information, application data, contact data, business card data, and directory data.

Region Signatures

[0179] If the “region has signature” flag in the region flags is set then the signature field contains a signature with a maximum width of 36 bits. The signature is typically a random number associated with the region ID in a secure database. The signature is ideally generated using a truly random process, such as a quantum process, or by distilling randomness from random events.

[0180] In an online environment the signature can be validated, in conjunction with the region ID, by querying a server with access to the secure database.

[0181] If the “region has embedded data” and “embedded data is signature” flags in the region flags are set then the surface coding contains a 160-bit cryptographic signature of the region ID. The signature is encoded in a one-block superblock.

[0182] In an online environment any number of signature fragments can be used, in conjunction with the region ID and optionally the random signature, to validate the signature by querying a server with knowledge of the full signature or the corresponding private key.

[0183] In an offline (or online) environment the entire signature can be recovered by reading multiple tags, and can then be validated using the corresponding public signature key. Signature verification is discussed in more detail below.

SECOND EXAMPLE TAG STRUCTURE

[0184] FIG. 21 shows the structure of a complete tag. Each of the six black circles is a target. The tag, and the overall pattern, has six-fold rotational symmetry at the physical level.

[0185] Each diamond-shaped region represents a symbol, and each symbol represents four bits of information.

**[0186]** FIG. 22 shows the structure of a symbol. It contains four macrodots, each of which represents the value of one bit by its presence (one) or absence (zero).

**[0187]** The macrodot spacing is specified by the parameter *s* throughout this document. It has a nominal value of 143 μm, based on 9 dots printed at a pitch of 1600 dots per inch. However, it is allowed to vary by ±10% according to the capabilities of the device used to produce the pattern.

**[0188]** FIG. 23 shows an array of five adjacent symbols. The macrodot spacing is uniform both within and between symbols.

**[0189]** FIG. 24 shows the ordering of the bits within a symbol. Bit zero is the least significant within a symbol; bit three is the most significant. Note that this ordering is relative to the orientation of the symbol. The orientation of a particular symbol within the tag is indicated by the orientation of the label of the symbol in the tag diagrams. In general, the orientation of all symbols within a particular segment of the tag have the same orientation, consistent with the bottom of the symbol being closest to the centre of the tag.

**[0190]** Only the macrodots are part of the representation of a symbol in the pattern. The diamond-shaped outline of a symbol is used in this document to more clearly elucidate the structure of a tag. FIG. 25, by way of illustration, shows the actual pattern of a tag with every bit set. Note that, in practice, every bit of a tag can never be set.

**[0191]** A macrodot is nominally circular with a nominal diameter of (5/9)*s*. However, it is allowed to vary in size by ±10% according to the capabilities of the device used to produce the pattern.

**[0192]** A target is nominally circular with a nominal diameter of (17/9)*s*. However, it is allowed to vary in size by ±10% according to the capabilities of the device used to produce the pattern.

**[0193]** The tag pattern is allowed to vary in scale by up to ±10% according to the capabilities of the device used to produce the pattern. Any deviation from the nominal scale is recorded in the tag data to allow accurate generation of position samples.

**[0194]** Each symbol shown in the tag structure in FIG. 21 has a unique label. Each label consists an alphabetic prefix and a numeric suffix.

Tag Group

**[0195]** Tags are arranged into tag groups. Each tag group contains three tags arranged in a line. Each tag therefore has one of three possible tag types according to its location within the tag group. The tag types are labelled P, Q and R, as shown in FIG. 26.

**[0196]** FIG. 27 shows how tag groups are repeated in a continuous tiling of tags. The tiling guarantees the any set of three adjacent tags contains one tag of each type.

Orientation-Indicating Cyclic Position Code

**[0197]** The tag contains a 2<sup>3</sup>-ary (6,1) cyclic position codeword (this work is currently the subject of two pending US patent applications, entitled “Cyclic position codes” and “Orientation indicating cyclic position codes” with application Ser. Nos. 10/120,441 and 10/409,864, respectively) which can be decoded at any of the six possible orientations of the tag to determine the actual orientation of the tag. Symbols

which are part of the cyclic position codeword have a prefix of “R” and are numbered 0 to 5 in order of increasing significance.

**[0198]** The layout of the orientation-indicating cyclic position codeword is shown in FIG. 28.

**[0199]** The cyclic position codeword is (0, 5, 6, 9, A<sub>16</sub>, F<sub>16</sub>). Note that it only uses six distinct symbol values, even though a four-bit symbol has sixteen possible values. During decoding, any unused symbol value should, if detected, be treated as an erasure. To maximise the probability of low-weight bit error patterns causing erasures rather than symbol errors, the symbol values are chosen to be evenly-spaced on the hypercube.

**[0200]** The minimum distance of the cyclic position code is 6, hence its error-correcting capacity is two symbols in the presence of up to one erasure, one symbol in the presence of two or three erasures, and no symbols in the presence of four or more erasures.

Local Codeword

**[0201]** The tag locally contains one complete codeword, labelled A, which is used to encode information unique to the tag. The codeword is of a punctured 2<sup>4</sup>-ary (12,7) Reed-Solomon code. The tag therefore encodes up to 28 bits of information unique to the tag.

**[0202]** The layout of the local codeword is shown in FIG. 29.

Distributed Codewords

**[0203]** The tag also contains fragments of six codewords, labelled B through G, which are distributed across three adjacent tags and which are used to encode information common to a set of contiguous tags. Each codeword is of a punctured 2<sup>4</sup>-ary (12,7) Reed-Solomon code. Any three adjacent tags therefore together encode up to 168 bits of information common to a set of contiguous tags.

**[0204]** The layout of the first four fragments of the six codewords B through G in tag type P is shown in FIG. 30. The layout in the other tag types follows the layout in tag type P, with symbols 4 through 7 in tag type Q, and fragments 8 through 11 in tag type Q.

**[0205]** The layout of the six complete codewords B through G, distributed across the three tag types P, Q and R, is shown in FIG. 31.

**[0206]** As shown earlier in FIG. 27, the tiling guarantees the any set of three adjacent tags contains one tag of each type, and therefore contains a complete set of distributed codewords. The tag type, used to determine the registration of the distributed codewords with respect to a particular set of adjacent tags, is inferred from the x-y coordinate encoded in the local codeword of each tag.

Tag Segment Geometry

**[0207]** FIG. 32 shows the geometry of a tag segment.

**[0208]** FIG. 33 shows the spacing *d* between tag segments, required to maintain consistent spacing between macrodots, where *d* is given by:

$$d=(1-\sqrt{3}/2)s$$

**[0209]** FIG. 34 shows the effect of the inter-segment spacing *d* on target position. Compared with their nominal positions in relation to closely-packed segments (i.e. with *d*=0), diagonal targets must be displaced by

$(\Delta_x, \Delta_y) = (\pm 1/\sqrt{3}, 0)d$ ,  
and horizontal targets must be displaced by  
 $(\Delta_x, \Delta_y) = (\pm 2/\sqrt{3}, 0)d$ .

Reed-Solomon Encoding

[0210] Codewords are encoded using a punctured  $2^4$ -ary (12,7) Reed-Solomon code.

[0211] A  $2^4$ -ary (12,7) Reed-Solomon code encodes 28 data bits (i.e. seven 4-bit symbols) and 20 redundancy bits (i.e. five 4-bit symbols) in each codeword. Its error-detecting capacity is five symbols. Its error-correcting capacity is two symbols.

[0212] As shown in FIG. 35, codeword coordinates are indexed in coefficient order, and the data bit ordering follows the codeword bit ordering.

[0213] A punctured  $2^4$ -ary (12,7) Reed-Solomon code is a  $2^4$ -ary (15,7) Reed-Solomon code with three redundancy coordinates removed. The removed coordinates are the most significant redundancy coordinates.

The code has the following primitive polynomial:

$$p(x) = x^4 + x + 1$$

[0214] The code has the following generator polynomial:

$$g(x) = (x + \alpha)(x + \alpha^2) \dots (x + \alpha^8)$$

[0215] For a detailed description of Reed-Solomon codes, refer to Wicker, S. B. and V. K. Bhargava, eds., *Reed-Solomon Codes and Their Applications*, IEEE Press, 1994.

Tag Coordinate Space

[0216] The tag coordinate space has two orthogonal axes labelled x and y respectively. When the positive x axis points to the right then the positive y axis points down.

[0217] The surface coding does not specify the location of the tag coordinate space origin on a particular tagged surface, nor the orientation of the tag coordinate space with respect to the surface. This information is application-specific. For example, if the tagged surface is a sheet of paper, then the application which prints the tags onto the paper may record the actual offset and orientation, and these can be used to normalise any digital ink subsequently captured in conjunction with the surface.

[0218] The position encoded in a tag is defined in units of tags. Tag coordinates are arranged as shown in FIG. 36, where the tag with coordinate (0,0) is a P type tag. By convention, the position of a tag with an even y coordinate is defined to be the position of the center of the tag. The position of a tag with an odd y coordinate is therefore defined to be the position of the midpoint between the center of the tag and the center of its neighboring tag on the left.

[0219] Horizontal and vertical tag units, based on center-to-center tag tag spacings, are given by:

$$u_x = 4(2\sqrt{3}s) + 2d \cong 14.1s$$

$$u_y = 6(2s) + 2\left(d\frac{\sqrt{3}}{2}\right) \cong 12.2s$$

where d is the inter-segment spacing given by

$$d = (1 - \sqrt{3}/2)s$$

[0220] If the three tag types P, Q and R are assigned values 0, 1 and 2 respectively, then the type t of a tag is inferred from its (x,y) coordinate as follows. If y is even, then:

$$t = x \text{ modulo } 3$$

if y is odd, then:

$$t = (x-1) \text{ modulo } 3$$

Tag Information Content

[0221] Table 7 defines the information fields embedded in the surface coding. Table 8 defines how these fields map to codewords.

TABLE 7

Field Definitions	
field	width description
<u>per tag</u>	
X coordinate	10 The unsigned x coordinate of the tag allows a maximum x coordinate value of approximately 2.1 m (based on EQ 4).
Y coordinate	10 The unsigned y coordinate of the tag allows a maximum y coordinate value of approximately 1.8 m (based on EQ 5).
active area flag	1 A flag indicating whether the tag is a member of an active area. b'1' indicates membership.
active area map flag	1 A flag indicating whether an active area map is present. b'1' indicates the presence of a map (see next field). If the map is absent then the value of each map entry is derived from the active area flag (see previous field).
active area map	6 A map of which of the tag's immediate six neighbours are members of an active area. b'1' indicates membership - FIG. 37 indicates the bit ordering of the map
data fragment	6 A fragment of an embedded data stream. Only present if the active area map is absent.
<u>per tag group</u>	
encoding format	12 The format of the encoding. 0: the present encoding Other values are TBA.
macrodot spacing adjustment	16 The difference between the actual macrodot spacing and the nominal macrodot spacing, in nm units, in sign-magnitude format - the nominal macrodot spacing is 142875 nm (based on 1600 dpi and 9 dots per macrodot)
region flags	12 Flags controlling the interpretation and routing of region-related information. 0: region ID is an EPC 1: region is linked 2: region is interactive 3: region is signed 4: region includes data 5: region relates to mobile application Other bits are reserved and must be zero.
region ID	112 The ID of the region containing the tags.
CRC	16 A CRC (CCITT CRC-16) of tag group data.

[0222] The active area map indicates whether the corresponding tags are members of an active area. An active area is an area within which any captured input should be immediately forwarded to the corresponding Hyperlabel server for interpretation. It also allows the Hyperlabel sensing device to signal to the user that the input will have an immediate effect.

TABLE 8

Mapping of fields to codewords				
codeword	codeword bits	field width	field bits	field
A	9:0	10	all	x coordinate
	19:10	10	all	y coordinate
	20	1	all	active area flag
	21	1	all	active area map flag
	27:22	6	all	active area map data fragment
B	11:0	12	all	Encoding format
	27:12	16	all	Macrodot spacing adjustment region flags
	27:12	16	27:12	region ID
D	27:0	28	55:28	
E	27:0	28	83:56	
F	27:0	28	111:84	
G	11:0	12	11:0	
	27:12	16	all	CRC

Embedded Data

[0223] If the “region includes data” flag in the region flags is set then the surface coding contains embedded data. The data is encoded in multiple contiguous tags’ data fragments, and is replicated in the surface coding as many times as it will fit.

[0224] The embedded data is encoded in such a way that a random and partial scan of the surface coding containing the embedded data can be sufficient to retrieve the entire data. The scanning system reassembles the data from retrieved fragments, and reports to the user when sufficient fragments have been retrieved without error.

[0225] As shown in Table 9, a 216-bit data block encodes 160 bits of data.

TABLE 9

Embedded data block		
field	width	Description
data type	16	The type of the data in the superblock. Values include: 0: type is controlled by region flags 1: MIME Other values are TBA.
superblock width	12	The width of the superblock, in blocks.
superblock height	12	The height of the superblock, in blocks.
data	160	The block data.
CRC	16	A CRC of the block data.
total	216	

[0226] The block data is encoded in the data fragments of a contiguous group of 36 tags arranged in a 6x6 square as shown in FIG. 38. A tag belongs to a block whose integer x and y coordinates are the tag’s x and y coordinates divided by 6. Within each block the data is arranged into tags with increasing x coordinate within increasing y coordinate.

[0227] A data fragment may be missing from a block where an active area map is present. However, the missing data fragment is likely to be recoverable from another copy of the block.

[0228] Data of arbitrary size is encoded into a superblock consisting of a contiguous set of blocks arranged in a rect-

angle. The size of the superblock is encoded in each block. A block belongs to a superblock whose integer coordinate is the block’s coordinate divided by the superblock size. Within each superblock the data is arranged into blocks with increasing x coordinate within increasing y coordinate.

[0229] The superblock is replicated in the surface coding as many times as it will fit, including partially along the edges of the surface coding.

[0230] The data encoded in the superblock may include more precise type information, more precise size information, and more extensive error detection and/or correction data.

General Considerations

Cryptographic Signature of Region ID

[0231] If the “region is signed” flag in the region flags is set then the surface coding contains a 160-bit cryptographic signature of the region ID. The signature is encoded in a one-block superblock.

[0232] In an online environment any signature fragment can be used, in conjunction with the region ID, to validate the signature. In an offline environment the entire signature can be recovered by reading multiple tags, and can then be validated using the corresponding public signature key.

MIME Data

[0233] If the embedded data type is “MIME” then the superblock contains Multipurpose Internet Mail Extensions (MIME) data according to RFC 2045 (Freed, N., and N. Borenstein, “Multipurpose Internet Mail Extensions (MIME)—Part One: Format of Internet Message Bodies”, RFC 2045, November 1996), RFC 2046 (Freed, N., and N. Borenstein, “Multipurpose Internet Mail Extensions (MIME)—Part Two: Media Types”, RFC 2046, November 1996) and related RFCs. The MIME data consists of a header followed by a body. The header is encoded as a variable-length text string preceded by an 8-bit string length. The body is encoded as a variable-length type-specific octet stream preceded by a 16-bit size in big-endian format.

[0234] The basic top-level media types described in RFC 2046 include text, image, audio, video and application.

[0235] RFC 2425 (Howes, T., M. Smith and F. Dawson, “A MIME Content-Type for Directory Information”, RFC 2045, September 1998) and RFC 2426 (Dawson, F., and T. Howes, “vCard MIME Directory Profile”, RFC 2046, September 1998) describe a text subtype for directory information suitable, for example, for encoding contact information which might appear on a business card.

Encoding and Printing Considerations

[0236] The Print Engine Controller (PEC) (which is the subject of a number of pending US patent applications, including: Ser. No. 09/575,108; Ser. No. 10/727,162; Ser. No. 09/575,110; Ser. No. 09/607,985; U.S. Pat. No. 6,398,332; U.S. Pat. No. 6,394,573; U.S. Pat. No. 6,622,923) supports the encoding of two fixed (per-page) 2<sup>4</sup>-ary (15,7) Reed-Solomon codewords and four variable (per-tag) 2<sup>4</sup>-ary (15,7) Reed-Solomon codewords, although other numbers of codewords can be used for different schemes.

[0237] Furthermore, PEC supports the rendering of tags via a rectangular unit cell whose layout is constant (per page) but

whose variable codeword data may vary from one unit cell to the next. PEC does not allow unit cells to overlap in the direction of page movement.

[0238] A unit cell compatible with PEC contains a single tag group consisting of four tags. The tag group contains a single A codeword unique to the tag group but replicated four times within the tag group, and four unique B codewords. These can be encoded using five of PEC's six supported variable codewords. The tag group also contains eight fixed C and D codewords. One of these can be encoded using the remaining one of PEC's variable codewords, two more can be encoded using PEC's two fixed codewords, and the remaining five can be encoded and pre-rendered into the Tag Format Structure (TFS) supplied to PEC.

[0239] PEC imposes a limit of 32 unique bit addresses per TFS row. The contents of the unit cell respect this limit. PEC also imposes a limit of 384 on the width of the TFS. The contents of the unit cell respect this limit.

[0240] Note that for a reasonable page size, the number of variable coordinate bits in the A codeword is modest, making encoding via a lookup table tractable. Encoding of the B codeword via a lookup table may also be possible. Note that since a Reed-Solomon code is systematic, only the redundancy data needs to appear in the lookup table.

Imaging and Decoding Considerations

[0241] The minimum imaging field of view required to guarantee acquisition of an entire tag has a diameter of 39.6s, i.e.

$$(2 \times (12+2))\sqrt{2}s$$

allowing for arbitrary alignment between the surface coding and the field of view. Given a macrodot spacing of 143 μm, this gives a required field of view of 5.7 mm.

[0242] Table 10 gives pitch ranges achievable for the present surface coding for different sampling rates, assuming an image sensor size of 128 pixels.

TABLE 10

Pitch ranges achievable for present surface coding for different sampling rates, computed using Optimize Hyperlabel Optics; dot pitch = 1600 dpi, macrodot pitch = 9 dots, viewing distance = 30 mm, nib-to-FOV separation = 1 mm, image sensor size = 128 pixels	
sampling rate	pitch range
2	-40 to +49
2.5	-27 to +36
3	-10 to +18

[0243] For the surface coding of the first example, the corresponding decoding sequence is as follows:

- [0244] locate targets of complete tag
- [0245] infer perspective transform from targets
- [0246] sample and decode any one of tag's four codewords
- [0247] determine codeword type and hence tag orientation
- [0248] sample and decode required local (A and B) codewords
- [0249] codeword redundancy is only 12 bits, so only detect errors
- [0250] on decode error flag bad position sample

- [0251] determine tag x-y location, with reference to tag orientation
- [0252] infer 3D tag transform from oriented targets
- [0253] determine nib x-y location from tag x-y location and 3D transform
- [0254] determine active area status of nib location with reference to active area map
- [0255] generate local feedback based on nib active area status
- [0256] determine tag type from A codeword
- [0257] sample and decode required global (C and D) codewords (modulo window alignment, with reference to tag type)
- [0258] although codeword redundancy is only 12 bits, correct errors; subsequent CRC verification will detect erroneous error correction
- [0259] verify tag group data CRC
- [0260] on decode error flag bad region ID sample
- [0261] determine encoding type, and reject unknown encoding
- [0262] determine region flags
- [0263] determine region ID
- [0264] encode region ID, nib x-y location, nib active area status in digital ink
- [0265] route digital ink based on region flags
- [0266] Note that region ID decoding need not occur at the same rate as position decoding.
- [0267] Note that decoding of a codeword can be avoided if the codeword is found to be identical to an already-known good codeword.
- [0268] For the surface coding of the alternative first example, the corresponding decoding sequence is as follows:
  - [0269] locate targets of complete tag
  - [0270] infer perspective transform from targets
  - [0271] sample cyclic position code
  - [0272] decode cyclic position code
  - [0273] determine orientation from cyclic position code
  - [0274] sample and decode local Reed-Solomon codeword
  - [0275] determine tag x-y location
  - [0276] infer 3D tag transform from oriented targets
  - [0277] determine nib x-y location from tag x-y location and 3D transform
  - [0278] determine active area status of nib location with reference to active area map
  - [0279] generate local feedback based on nib active area status
  - [0280] determine tag type
  - [0281] sample distributed Reed-Solomon codewords (modulo window alignment, with reference to tag type)
  - [0282] decode distributed Reed-Solomon codewords
  - [0283] verify tag group data CRC
  - [0284] on decode error flag bad region ID sample
  - [0285] determine encoding type, and reject unknown encoding
  - [0286] determine region flags
  - [0287] determine region ID
  - [0288] encode region ID, nib x-y location, nib active area status in digital ink
  - [0289] route digital ink based on region flags
- [0290] Region ID decoding need not occur at the same rate as position decoding and decoding of a codeword can be avoided if the codeword is found to be identical to an already-known good codeword.

**[0291]** If the high-order coordinate width is non-zero, then special care must be taken on boundaries between tags where the low-order x or y coordinate wraps, otherwise codeword errors may be introduced. If wrapping is detected from the low-order x or y coordinate (i.e. it contains all zero bits or all one bits), then the corresponding high-order coordinate can be adjusted before codeword decoding. In the absence of genuine symbol errors in the high-order coordinate, this will prevent the inadvertent introduction of codeword errors.

Expanded Tag

**[0292]** The tag can be expanded to increase its data capacity by adding additional bands of symbols about its circumference. This appendix describes an expanded tag with one additional band of symbols. While the tag described in the main part of the document has a raw capacity of 36 symbols, the expanded tag has a raw capacity of 60 symbols.

**[0293]** The capacity of the expanded tag is precisely sufficient to allow the inclusion of a complete 160-bit digital signature in each tag group. This allows complete digital signature verification on a “single-click” interaction with the surface coding.

Tag Structure

**[0294]** FIG. 39 shows the structure of a complete (P type) expanded tag. Apart from the additional band of symbols and the related change in the positions of the targets, it has a similar physical structure to the tag described earlier.

**[0295]** In the expanded tag the macrodot spacing *s* has a nominal value of 111 μm, based on 7 dots printed at a pitch of 1600 dots per inch.

**[0296]** A macrodot is nominally circular with a nominal diameter of (3/7)*s*.

**[0297]** A target is nominally circular with a nominal diameter of (10/7)*s*.

**[0298]** The expanded tag, like the tag described earlier, also participates in a tag group, and each expanded tag has one of the three possible tag types P, Q and R.

**[0299]** The expanded tag, like the tag described earlier, contains an orientation-indicating cyclic position code.

Local Codeword

**[0300]** The expanded tag locally contains one complete codeword which is used to encode information unique to the tag. The codeword is of a punctured 2<sup>4</sup>-ary (12,7) Reed-Solomon code. The tag therefore encodes up to 28 bits of information unique to the tag.

**[0301]** The layout of the local codeword is shown in FIG. 40.

Distributed Codewords

**[0302]** The expanded tag contains fragments of twelve codewords, labelled B through M, which are distributed across three adjacent tags and which are used to encode information common to a set of contiguous tags. Each codeword is of a punctured 2<sup>4</sup>-ary (12,7) Reed-Solomon code. Any three adjacent tags therefore together encode up to 336 bits of information common to a set of contiguous tags.

**[0303]** The layout of the first four fragments of the six codewords B through G in tag type P is shown in FIG. 41. The layout in the other tag types follows the layout in tag type P, with symbols 4 through 7 in tag type Q, and fragments 8 through 11 in tag type Q.

**[0304]** The layout of the first four fragments of the six codewords H through M in tag type P is shown in FIG. 42. The layout in the other tag types follows the layout in tag type P, with symbols 4 through 7 in tag type Q, and fragments 8 through 11 in tag type Q.

**[0305]** As shown earlier in FIG. 37, the tiling guarantees the any set of three adjacent tags contains one tag of each type, and therefore contains a complete set of distributed codewords. The tag type, used to determine the registration of the distributed codewords with respect to a particular set of adjacent tags, is inferred from the x-y coordinate encoded in the local codeword of each tag.

Tag Coordinate Space

**[0306]** The tag coordinate space encoded in the expanded tag is identical to that encoded in the tag described earlier, with the exception that tag units are different (due both to the change in tag structure and the change in macrodot spacing).

**[0307]** Horizontal and vertical tag units, based on center-to-center tag tag spacings, are given by:

$$u_x = 5(2\sqrt{3}s) + 2d \cong 17.6s$$

$$u_y = 7.5(2s) + 2\left(d\frac{\sqrt{3}}{2}\right) \cong 15.2s$$

where *d* is the inter-segment spacing given by

$$d = (1 - \sqrt{3}/2)s$$

Tag Information Content

**[0308]** Table 11 defines the information fields embedded in the expanded tag surface coding. Table 12 defines how these fields map to codewords.

TABLE 11

Field definitions		
Field	width	description
<u>per tag</u>		
x coordinate	10	The unsigned x coordinate of the tag - allows a maximum x coordinate value of approximately 2.0 m (based on EQ 8).
y coordinate	10	The unsigned y coordinate of the tag - allows a maximum y coordinate value of approximately 1.7 m (based on EQ 9)
active area flag	1	A flag indicating whether the tag is a member of an active area. b'1' indicates membership.
active area map flag	1	A flag indicating whether an active area map is present. b'1' indicates the presence of a map (see next field). If the map is absent then the value of each map entry is derived from the active area flag (see previous field).
active area map	6	A map of which of the tag's immediate six neighbours are members of an active area. b'1' indicates membership - FIG. 37 indicates the bit ordering of the map
data fragment	6	A fragment of an embedded data stream. Only present if the active area map is absent.
<u>per tag group</u>		
encoding format	12	The format of the encoding. Refer to Table 5 for values.
macrodot spacing	16	The difference between the actual macrodot spacing and the nominal macrodot spacing, in

TABLE 11-continued

Field definitions	
Field	width description
adjustment	nm units, in sign-magnitude format - the nominal macrodot spacing is 111125 nm (based on 1600 dpi and 7 dots per macrodot)
region flags	12 Flags controlling the interpretation and routing of region-related information. Refer to Table 5 for values.
region ID	112 The ID of the region containing the tags.
Signature	160 A digital signature of the region ID.
CRC	16 A CRC (CCITT CRC-16) of tag group data.

TABLE 12

Mapping of fields to codewords				
codeword	codeword bits	field width	field bits	field
A	9:0	10	all	x coordinate
	19:10	10	all	y coordinate
	20	1	all	active area flag
	21	1	all	active area map flag
	27:22	6	all	active area map
B	27:22	6	all	data fragment
	11:0	12	all	encoding format
	27:12	16	all	macrodot spacing adjustment
C	11:0	12	all	region flags
	27:12	16	27:12	region ID
D	27:0	28	55:28	
E	27:0	28	83:56	
F	27:0	28	111:84	
G	11:0	12	11:0	
	27:12	16	all	CRC
H	27:0	28	27:0	signature
I	27:0	28	55:28	
J	27:0	28	83:56	
K	27:0	28	111:84	
L	27:0	28	139:112	
M	19:0	20	159:140	
	27:20	8	all	unused

Encoding and Printing Considerations

[0309] The tag group unit cell of the expanded tag only respects PEC's TFS width limit if the macrodot spacing is reduced from 9 to 7 dots, as reflected in the macrodot spacing s of 111 μm.

Imaging and Decoding Considerations

[0310] The minimum imaging field of view required to guarantee acquisition of an entire expanded tag has a diameter of 44s i.e.

$$2(1+8+2)2s,$$

allowing for arbitrary alignment between the surface coding and the field of view. Given a macrodot spacing of 111 μm this gives a required field of view of approximately 4.0 mm.

Surface Coding Security

Security Requirements

[0311] Item security can be defined to have two related purposes:

- [0312] to allow authentication of an item
- [0313] to prevent forgery of an item

[0314] The greater the difficulty of forgery, the greater the trustworthiness of authentication. When an item is coded, Hyperlabel surface coding security has two corresponding purposes:

- [0315] to allow authentication of a coded item
- [0316] to prevent forgery of a coded item with a novel item ID

[0317] If a user is able to determine the authenticity of the surface coding of an item, then the user may be able to make an informed decision about the likely authenticity of the item.

[0318] If it is intractable to forge the surface coding for a novel ID, then the only tractable way of forging an item with an authentic surface coding is to duplicate the surface coding of an existing item (and hence its ID). If the user is able to determine by other means that the ID of an item is likely to be unique, then the user may assume that the item is authentic.

[0319] Since the Hyperlabel surface coding allows meaningful interaction between a sensing device and a coded surface during a purely local interaction, it is desirable for the surface coding to support authentication during a similarly local interaction, i.e. without requiring an increase in the size of the sensing device field of view.

[0320] Since no a priori relationship exists between creators of authentic coded items and users potentially wishing to authenticate such items, it is undesirable to require a trust relationship between creators and users. For example, it is undesirable to require that creators share secret signature keys with users.

[0321] It is reasonable for many users to rely on online access to an authenticator trusted by a creator for the purposes of authenticating items. Conversely, it is desirable to allow authentication to take place in the absence of online access.

Security Discussion

[0322] As described above, authentication relies on verifying the correspondence between data and a signature of that data. The greater the difficulty in forging a signature, the greater the trustworthiness of signature-based authentication.

[0323] The item ID is unique and therefore provides a basis for a signature. If online authentication access is assumed, then the signature may simply be a random number associated with the item ID in an authentication database accessible to the trusted online authenticator. The random number may be generated by any suitable method, such as via a deterministic (pseudo-random) algorithm, or via a stochastic physical process. A keyed hash or encrypted hash may be preferable to a random number since it requires no additional space in the authentication database. However, a random signature of the same length as a keyed signature is more secure than the keyed signature since it is not susceptible to key attacks. Equivalently, a shorter random signature confers the same security as a longer keyed signature.

[0324] In the limit case no signature is actually required, since the mere presence of the item ID in the database indicates authenticity. However, the use of a signature limits a forger to forging items he has actually sighted.

[0325] To prevent forgery of a signature for an unsighted ID, the signature must be large enough to make exhaustive search via repeated accesses to the online authenticator intractable. If the signature is generated using a key rather than randomly, then its length must also be large enough to prevent the forger from deducing the key from known ID-

signature pairs. Signatures of a few hundred bits are considered secure, whether generated using private or secret keys.

**[0326]** While it may be practical to include a reasonably secure random signature in a tag (or local tag group), particularly if the length of the ID is reduced to provide more space for the signature, it may be impractical to include a secure ID-derived signature in a tag. To support a secure ID-derived signature, we can instead distribute fragments of the signature across multiple tags. If each fragment can be verified in isolation against the ID, then the goal of supporting authentication without increasing the sensing device field of view is achieved. The security of the signature can still derive from the full length of the signature rather than from the length of a fragment, since a forger cannot predict which fragment a user will randomly choose to verify. A trusted authenticator can always perform fragment verification since they have access to the key and/or the full stored signature, so fragment verification is always possible when online access to a trusted authenticator is available.

**[0327]** Fragment verification requires that we prevent brute force attacks on individual fragments, otherwise a forger can determine the entire signature by attacking each fragment in turn. A brute force attack can be prevented by throttling the authenticator on a per-ID basis. However, if fragments are short, then extreme throttling is required. As an alternative to throttling the authenticator, the authenticator can instead enforce a limit on the number of verification requests it is willing to respond to for a given fragment number. Even if the limit is made quite small, it is unlikely that a normal user will exhaust it for a given fragment, since there will be many fragments available and the actual fragment chosen by the user can vary. Even a limit of one can be practical. More generally, the limit should be proportional to the size of the fragment, i.e. the smaller the fragment the smaller the limit. Thus the experience of the user would be somewhat invariant of fragment size. Both throttling and enforcing fragment verification limits imply serialisation of requests to the authenticator. A fragment verification limit need only be imposed once verification fails, i.e. an unlimited number of successful verifications can occur before the first failure. Enforcing fragment verification limits further requires the authenticator to maintain a per-fragment count of satisfied verification requests.

**[0328]** A brute force attack can also be prevented by concatenating the fragment with a random signature encoded in the tag. While the random signature can be thought of as protecting the fragment, the fragment can also be thought of as simply increasing the length of the random signature and hence increasing its security. A fragment verification limit can make verification subject to a denial of service attack, where an attacker deliberately exceeds the limit with invalid verification request in order to prevent further verification of the item ID in question. This can be prevented by only enforcing the fragment verification limit for a fragment when the accompanying random signature is correct.

**[0329]** Fragment verification may be made more secure by requiring the verification of a minimum number of fragments simultaneously.

**[0330]** Fragment verification requires fragment identification. Fragments may be explicitly numbered, or may more economically be identified by the two-dimensional coordinate of their tag, modulo the repetition of the signature across a continuous tiling of tags.

**[0331]** The limited length of the ID itself introduces a further vulnerability. Ideally it should be at least a few hundred bits. In the netpage surface coding scheme it is 96 bits or less. To overcome this the ID may be padded. For this to be effective the padding must be variable, i.e. it must vary from one ID to the next. Ideally the padding is simply a random number, and must then be stored in the authentication database indexed by ID. If the padding is deterministically generated from the ID then it is worthless.

**[0332]** Offline authentication of secret-key signatures requires the use of a trusted offline authentication device. The QA integrated circuit (which is the subject of a number of pending US patent applications, including Ser. No. 09/112,763; Ser. No. 09/112,762; Ser. No. 09/112,737; Ser. No. 09/112,761; Ser. No. 09/113,223) provides the basis for such a device, although of limited capacity. The QA integrated circuit can be programmed to verify a signature using a secret key securely held in its internal memory. In this scenario, however, it is impractical to support per-ID padding, and it is impractical even to support more than a very few secret keys. Furthermore, a QA integrated circuit programmed in this manner is susceptible to a chosen-message attack. These constraints limit the applicability of a QA-integrated circuit-based trusted offline authentication device to niche applications.

**[0333]** In general, despite the claimed security of any particular trusted offline authentication device, creators of secure items are likely to be reluctant to entrust their secret signature keys to such devices, and this is again likely to limit the applicability of such devices to niche applications.

**[0334]** By contrast, offline authentication of public-key signatures (i.e. generated using the corresponding private keys) is highly practical. An offline authentication device utilising public keys can trivially hold any number of public keys, and may be designed to retrieve additional public keys on demand, via a transient online connection, when it encounters an ID for which it knows it has no corresponding public signature key. Untrusted offline authentication is likely to be attractive to most creators of secure items, since they are able to retain exclusive control of their private signature keys.

**[0335]** A disadvantage of offline authentication of a public-key signature is that the entire signature must be acquired from the coding, violating our desire to support authentication with a minimal field of view. A corresponding advantage of offline authentication of a public-key signature is that access to the ID padding is no longer required, since decryption of the signature using the public signature key generates both the ID and its padding, and the padding can then be ignored. A forger can not take advantage of the fact that the padding is ignored during offline authentication, since the padding is not ignored during online authentication.

**[0336]** Acquisition of an entire distributed signature is not particularly onerous. Any random or linear swipe of a hand-held sensing device across a coded surface allows it to quickly acquire all of the fragments of the signature. The sensing device can easily be programmed to signal the user when it has acquired a full set of fragments and has completed authentication. A scanning laser can also easily acquire all of the fragments of the signature. Both kinds of devices may be programmed to only perform authentication when the tags indicate the presence of a signature.

**[0337]** Note that a public-key signature may be authenticated online via any of its fragments in the same way as any signature, whether generated randomly or using a secret key.

The trusted online authenticator may generate the signature on demand using the private key and ID padding, or may store the signature explicitly in the authentication database. The latter approach obviates the need to store the ID padding.

[0338] Note also that signature-based authentication may be used in place of fragment-based authentication even when online access to a trusted authenticator is available.

[0339] Table 13 provides a summary of which signature schemes are workable in light of the foregoing discussion.

TABLE 13

Summary of workable signature schemes				
encoding in tags	acquisition from tags	signature generation	online authentication	offline authentication
Local	full	random	ok	Impractical to store per ID information Undesirable to store secret keys
		secret key	Signature too short to be secure	
		private key	Signature too short to be secure	
Distributed	fragment (s)	random	ok	impractical <sup>b</sup>
		secret key	ok	
		private key	ok	
	full	random	ok	impractical <sup>b</sup>
		secret key	ok	
		private key	ok	

Security Specification

[0340] FIG. 43 shows an example item signature object model.

[0341] An item has an ID (X) and other details (not shown). It optionally has a secret signature (Z). It also optionally has a public-key signature. The public-key signature records the signature (S) explicitly, and/or records the padding (P) used in conjunction with the ID to generate the signature. The public-key signature has an associated public-private key pair (K, L). The key pair is associated with a one or more ranges of item IDs.

[0342] Typically issuers of security documents and pharmaceuticals will utilise a range of IDs to identify a range of documents or the like. Following this, the issuer will then use these details to generate respective IDs for each item, or document to be marked.

[0343] Authentication of the product can then be performed online or offline by sensing the tag data encoded within the tag, and performing the authentication using a number of different mechanisms depending on the situation.

[0344] Examples of the processes involved will now be described for public and private key encryption respectively.

Authentication Based on Public-Key Signature

[0345] Setup per ID range:

[0346] generate public-private signature key pair (K, L)

[0347] store key pair (K, L) indexed by ID range

[0348] Setup per ID:

[0349] generate ID padding (P)

[0350] retrieve private signature key (L) by ID (X)

[0351] generate signature (S) by encrypting ID (X) and padding (P) using private key (L):

$$S \leftarrow E_L(X, P)$$

[0352] store signature (S) in database indexed by ID (X) (and/or store padding (P))

[0353] encode ID (X) in all tag groups

[0354] encode signature (S) across multiple tags in repeated fashion

[0355] Online fragment-based authentication (user):

[0356] acquire ID (X) from tags

[0357] acquire position (x, y)<sub>i</sub> and signature fragment (T<sub>i</sub>) from tag

[0358] generate fragment number (i) from position (x, y)<sub>i</sub>:

$$i \leftarrow F[(x, y)_i]$$

[0359] look up trusted authenticator by ID (X)

[0360] transmit ID (X), fragment (T<sub>i</sub>) and fragment number (i) to trusted authenticator

[0361] Online fragment-based authentication (trusted authenticator):

[0362] receive ID (X), fragment (T<sub>i</sub>) and fragment number (i) from user

[0363] retrieve signature (S) from database by ID (X) (or re-generate signature)

[0364] compare received fragment (T<sub>i</sub>) with corresponding fragment of signature (S<sub>i</sub>)

[0365] report authentication result to user

[0366] Offline signature-based authentication (user):

[0367] acquire ID from tags (X)

[0368] acquire positions (x, y)<sub>i</sub> and signature fragments (T<sub>i</sub>) from tag

[0369] generate fragment numbers (i) from positions (x, y)<sub>i</sub>:

$$i \leftarrow F[(x, y)_i]$$

[0370] generate signature (T) from (n) fragments:

$$T \leftarrow T_0 | T_1 | \dots | T_{n-1}$$

[0371] retrieve public signature key (K) by ID (X)

[0372] decrypt signature (T) using public key (K) to obtain ID (X') and padding (P')

$$X' | P' \leftarrow D_K(T)$$

[0373] compare acquired ID (X) with decrypted ID (X')

[0374] report authentication result to user

Authentication Based on Secret-Key Signature

[0375] Setup per ID:

[0376] generate secret (Z)

[0377] store secret (Z) in database indexed by ID (X)

[0378] encode ID (X) and secret (Z) in all tag groups

[0379] Online secret-based authentication (user):

[0380] acquire ID (X) from tags

[0381] acquire secret (Z') from tags

[0382] look up trusted authenticator by ID

[0383] transmit ID (X) and secret (Z') to trusted authenticator

[0384] Online secret-based authentication (trusted authenticator):

[0385] receive ID (X) and secret (Z') from user

[0386] retrieve secret (Z) from database by ID (X)

[0387] compared received secret (Z') with secret (Z)

[0388] report authentication result to user

[0389] As discussed earlier, secret-based authentication may be used in conjunction with fragment-based authentication.

Cryptographic Algorithms

[0390] When the public-key signature is authenticated offline, the user's authentication device typically does not have access to the padding used when the signature was originally generated. The signature verification step must therefore decrypt the signature to allow the authentication device to compare the ID in the signature with the ID acquired from the tags. This precludes the use of algorithms which don't perform the signature verification step by decrypting the signature, such as the standard Digital Signature Algorithm U.S. Department of Commerce/National Institute of Standards and Technology, Digital Signature Standard (DSS), FIPS 186-2, 27 Jan. 2000.

[0391] RSA encryption is described in:

[0392] Rivest, R. L., A. Shamir, and L. Adleman, "A Method for Obtaining Digital Signatures and Public-Key Cryptosystems", Communications of the ACM, Vol. 21, No. 2, February 1978, pp. 120-126

[0393] Rivest, R. L., A. Shamir, and L. M. Adleman, "Cryptographic communications system and method", U.S. Pat. No. 4,405,829, issued 20 Sep. 1983

[0394] RSA Laboratories, PKCS #1 v2.0: RSA Encryption Standard, Oct. 1, 1998

[0395] RSA provides a suitable public-key digital signature algorithm that decrypts the signature. RSA provides the basis for the ANSI X9.31 digital signature standard American National Standards Institute, ANSI X9.31-1998, Digital Signatures Using Reversible Public Key Cryptography for the Financial Services Industry (rDSA), Sep. 8, 1998. If no padding is used, then any public-key signature algorithm can be used.

[0396] In the Hyperlabel surface coding scheme the ID is 96 bits long or less. It is padded to 160 bits prior to being signed.

[0397] The padding is ideally generated using a truly random process, such as a quantum process [14,15], or by distilling randomness from random events Schneier, B., Applied Cryptography, Second Edition, John Wiley & Sons 1996.

[0398] In the Hyperlabel surface coding scheme the random signature, or secret, is 36 bits long or less. It is also ideally generated using a truly random process. If a longer random signature is required, then the length of the item ID in the surface coding can be reduced to provide additional space for the signature.

Security Tagging and Tracking

[0399] Currency, checks and other monetary documents can be tagged in order to detect currency counterfeiting and counter money laundering activities. The Hyperlabel tagged currency can be validated, and tracked through the monetary system. Hyperlabel tagged products such as pharmaceuticals can be tagged allowing items to be validated and tracked through the distribution and retail system.

[0400] A number of examples of the concepts of Hyperlabel security tagging and tracking referring specifically to bank notes and pharmaceuticals, however Hyperlabel tagging can equally be used to securely tag and track other products, for example, traveller's checks, demand deposits, passports, chemicals etc.

[0401] Hyperlabel tagging, with the netpage system, provides a mechanism for securely validating and tracking objects.

[0402] Hyperlabel tags on the surface of an object uniquely identify the object. Each Hyperlabel tag contains information including the object's unique ID, and the tag's location on the Hyperlabel tagged surface. A Hyperlabel tag also contains a signature fragment which can be used to authenticate the object. A scanning laser or image sensor can read the tags on any part of the object to identify the object, validate the object, and allow tracking of the object.

Currency Tagging

[0403] Currency may be tagged with Hyperlabels in order to detect counterfeiting and allow tracking of currency movement. Hyperlabel tags can be printed over the entire bank note surface or can be printed in a smaller region of the note. Hyperlabel tagging can be used in addition to other security features such as holograms, foil strips, colour-shifting inks etc. A scanning laser or image sensor can read the tags on any part of the note to validate each individual note.

[0404] A Hyperlabel currency tag identifies the note currency, issue country, and note denomination. It also identifies the note's serial number, the note side (i.e. front or back), and it may contain other information (for example, the exact printing works where the note was printed). There are two note IDs for each physical bank note—one for each side of the note.

[0405] Each time a note is scanned its location is recorded. This location information can be collected in a central database allowing analysis and identification of abnormal money movements and detection of counterfeit notes. For example, in the case of sophisticated forgeries where Hyperlabel dot patterns are exactly duplicated, there will be multiple copies of exactly forged notes (at a minimum, the original and the forgery). If multiple identical notes appear in different places at the same time, all but one of the notes must be a forgery. All can then be treated as suspect.

[0406] Hyperlabel currency tags can be read by any Hyperlabel scanner. These scanners can be incorporated into a variety of devices to facilitate authentication and tracking, for example, automated teller machines, currency counters, and vending machines. Scanners may also be incorporated into devices such as:

- [0407] Currency counters
- [0408] Automated teller machines
- [0409] Cash registers
- [0410] POS checkouts
- [0411] Mobile phone with inbuilt scanner
- [0412] Netpage pens
- [0413] Vending machines
- [0414] Hyperlabel Supermarket Checkout
- [0415] Mobile Phone with Inbuilt Scanner
- [0416] Handheld Validity Scanner

[0417] Such scanners are multi-purpose since they can also be used to scan Hyperlabel tagged consumer goods and printed materials. A small hand-held scanner may also be used to scan and validate currency. When a scanner scans a note it notifies the currency server of the note details, the current date and time, and the scanner location (if known). Optionally the scanner may also send the identity of the person making the cash transaction, if known. This information would be available in respect of bank transactions, currency exchanges and large cash transactions. Currency tag-

ging is discussed in further detail in copending patent application Ser. Nos. 11/041,651 (Docket number: HYN001US), 11/041,609 (Docket number: HYN002US), Docket number: HYN003US, Docket number: HYN004US and Docket number: HYN005US.

#### Pharmaceutical Tagging

**[0418]** Hyperlabel tags can be printed over the entire surface of the pharmaceutical packaging, or only on a smaller area of the packaging. A Hyperlabel pharmaceutical tag contains the item's product ID and a serial number, to uniquely identify an individual item. The product ID identifies the item's National Drug Code (NDC) number. The NDC number is allocated and administered by the FDA (U.S. Food and Drug Administration) for drugs and drug-related items and identifies the product and manufacturer. Alternatively the tag may contain another product ID code, such as the European International Article Numbering (EAN) code, or EPC etc.

**[0419]** The pharmaceutical ID can be read by a scanner and used to look up details of the item's lot number and expiry date. Alternatively the lot number and expiry date may be contained in the pharmaceutical tag to allow off-line retrieval of this information by any scanner. The pharmaceutical ID may also be used to access details such as dosage and administration information, drug interactions, precautions, contraindications, product warnings, recall information, place of manufacture etc.

**[0420]** Each time a pharmaceutical item is scanned its location is recorded. This location information can be collected in a central database allowing analysis and identification of abnormal product movements and detection of counterfeit pharmaceuticals.

Suitable scanners can include:

- [0421]** Cash registers
- [0422]** POS checkouts
- [0423]** Mobile phone with inbuilt scanner
- [0424]** Netpage pens
- [0425]** Vending machines

**[0426]** Pharmaceutical tagging is discussed in further detail in copending patent applications.

#### Tracking

**[0427]** For the purpose of tracking and item validation the manufacturer, or other central authority, maintains a database which tracks the location and status of all items.

**[0428]** Hyperlabel scanners can be built into a variety of devices. Scanners may be fixed or mobile. A fixed scanner has a permanent, known location. A mobile scanner has no fixed location. A scanner may be on-line, i.e. have immediate access to the central database, or it may be off-line.

**[0429]** Scanners may be specific to a particular product application, such as a currency counter, or may be a generic Hyperlabel scanner. Hyperlabel scanners may be embedded in other multi-function devices, for example, a mobile phone or PDA.

**[0430]** A central database maintains up-to-date information on valid object IDs, an object ID hotlist (for all suspect object IDs), and a list of public keys corresponding to object IDs. The central server also maintains an object scanning history to track an object's movements. Each time an object is scanned, its timestamped location is recorded. If known, the details of the object owner may also be recorded. This information may be known particularly in the case of large finan-

cial transactions e.g. a large cash withdrawal from a bank. This object scanning history data can be used to detect illegal product movements, for example, the illegal import of a pharmaceutical. It can also be used to detect abnormal or suspicious product movements which may be indicative of product counterfeiting.

**[0431]** If an object is known to be stolen it can be immediately added to an object ID hotlist on the central server. This hotlist is automatically distributed to (or becomes accessible to) all on-line scanners, and will be downloaded to all off-line scanners on their next update. In this way the stolen status is automatically and rapidly disseminated to a huge number of outlets. Similarly, if an object is in any other way suspect it can be added to the hotlist so that its status is flagged to the person scanning the object.

**[0432]** An on-line scanner has instant access to the central server to allow checking of each object ID at the time of scanning. The object scanning history is also updated at the central server at the time the object is scanned.

**[0433]** An off-line scanner stores object status data internally to allow validation of a scanned object. The object status data includes valid ID range lists, an object ID hotlist, a public key list, and an object scanning history. Each time an object is scanned the details are recorded in the object scanning history. The object status data is downloaded from the central server, and the object scanning history is uploaded to the central server, each time the scanner connects.

**[0434]** A mobile scanner's location can be provided to the application by the scanner, if it is GPS-equipped. Alternatively the scanner's location can be provided by the network through which it communicates.

**[0435]** For example, if the hand-held scanner uses the mobile phone network, the scanner's location can be provided by the mobile phone network provider. There are a number of location technologies available. One is Assisted Global Positioning System (A-GPS). This requires a GPS-equipped handset, which receives positioning signals from GPS satellites. The phone network knows the approximate location of the handset (in this case the handset is also the scanner) from the nearest cell site. Based on this, the network tells the handset which GPS satellites to use in its position calculations. Another technology, which does not require the device to be GPS-equipped, is Uplink Time Difference of Arrival (U-TDOA). This determines the location of a wireless handset, using a form of triangulation, by comparing the time it takes a wireless handset's signal to reach several Location Measurement Units (LMUs) installed at the network's cell sites. The handset location is then calculated based on the differences in arrival times of the three (or more) signals.

#### Authentication

**[0436]** Each object ID has a signature. Limited space within the Hyperlabel tag structure makes it impractical to include a full cryptographic signature in a tag so signature fragments are distributed across multiple tags. A smaller random signature, or secret, can be included in a tag.

**[0437]** To avoid any vulnerability due to the limited length of the object ID, the object ID is padded, ideally with a random number. The padding is stored in an authentication database indexed by object ID. The authentication database may be managed by the manufacturer, or it may be managed by a third-party trusted authenticator.

**[0438]** Each Hyperlabel tag contains a signature fragment and each fragment (or a subset of fragments) can be verified,

in isolation, against the object ID. The security of the signature still derives from the full length of the signature rather than from the length of the fragment, since a forger cannot predict which fragment a user will randomly choose to verify.

**[0439]** Fragment verification requires fragment identification. Fragments may be explicitly numbered, or may be identified by the two-dimensional coordinate of their tag, modulo the repetition of the signature across continuous tiling of tags.

**[0440]** Note that a trusted authenticator can always perform fragment verification, so fragment verification is always possible when on-line access to a trusted authenticator is available.

#### Establishing Authentication Database

- [0441]** Prior to allocating a new range of IDs, some setup tasks are required to establish the authentication database.
- [0442]** For each range of IDs a public-private signature key pair is generated and the key pair is stored in the authentication database, indexed by ID range.
- [0443]** For each object ID in the range the following setup is required:
- [0444]** generate ID padding and store in authentication database, indexed by object ID
  - [0445]** retrieve private signature key by object ID
  - [0446]** generate signature by encrypting object ID and padding, using private key
  - [0447]** store signature in authentication database indexed by object ID, and/or store the padding, since the signature can be re-generated using the ID, padding and private key
  - [0448]** encode the signature across multiple tags in repeated fashion
- [0449]** This data is required for the Hyperlabel tags therefore the authentication database must be established prior to, or at the time of, printing of the Hyperlabels.
- [0450]** Security issues are discussed in more detail above.,

#### Off-Line Public-Key-Based Authentication

- [0451]** An off-line authentication device utilises public-key signatures. The authentication device holds a number of public keys. The device may, optionally, retrieve additional public keys on demand, via a transient on-line connection when it encounters an object ID for which it has no corresponding public key signature.
- [0452]** For off-line authentication, the entire signature is needed. The authentication device is swiped over the Hyperlabel tagged surface and a number of tags are read. From this, the object ID is acquired, as well as a number of signature fragments and their positions. The signature is then generated from these signature fragments. The public key is looked up, from the scanning device using the object ID. The signature is then decrypted using the public key, to give an object ID and padding. If the object ID obtained from the signature matches the object ID in the Hyperlabel tag then the object is considered authentic.
- [0453]** The off-line authentication method can also be used on-line, with the trusted authenticator playing the role of authenticator.

#### On-Line Public-Key-Based Authentication

- [0454]** An on-line authentication device uses a trusted authenticator to verify the authenticity of an object. For on-line authentication a single tag can be all that is required to

perform authentication. The authentication device scans the object and acquires one or more tags. From this, the object ID is acquired, as well as at least one signature fragment and its position. The fragment number is generated from the fragment position. The appropriate trusted authenticator is looked up by the object ID. The object ID, signature fragment, and fragment number are sent to the trusted authenticator.

**[0455]** The trusted authenticator receives the data and retrieves the signature from the authentication database by object ID. This signature is compared with the supplied fragment, and the authentication result is reported to the user.

#### On-Line Secret-Based Authentication

**[0456]** Alternatively or additionally, if a random signature or secret is included in each tag (or tag group), then this can be verified with reference to a copy of the secret accessible to a trusted authenticator. Database setup then includes allocating a secret for each object, and storing it in the authentication database, indexed by object ID.

**[0457]** The authentication device scans the object and acquires one or more tags. From this, the object ID is acquired, as well as the secret. The appropriate trusted authenticator is looked up by the object ID. The object ID and secret are sent to the trusted authenticator.

**[0458]** The trusted authenticator receives the data and retrieves the secret from the authentication database by object ID. This secret is compared with the supplied secret, and the authentication result is reported to the user.

**[0459]** Secret-based authentication can be used in conjunction with on-line fragment-based authentication is discussed in more detail above.

#### Product Scanning Interactions

**[0460]** Product Scanning at a retailer is illustrated in FIG. 44. When a store operator scans a Hyperlabel tagged product the tag data is sent to the service terminal (A). The service terminal sends the transaction data to the store server (B). The store server sends this data, along with the retailer details, to the manufacturer server (C). The Hyperlabel server knows which manufacturer server to send the message to from the object ID. On receipt of the input, the manufacturer server authenticates the object, if the manufacturer is the trusted authenticator. Alternatively the manufacturer server passes the data on to the authentication server to verify the object ID and signature (D). The authentication server sends the authentication result back to the manufacturer server (E). The manufacturer server checks the status of the object ID (against its valid ID lists and hotlist), and sends the response to the store server (F), which in turn send the result back the store service terminal (G). The store server could also communicate with the relevant authentication server directly.

**[0461]** The interaction detail for on-line product scanning at a retailer is shown in FIG. 45. The store operator scans the Hyperlabel tagged product. The scanner sends the scanner ID and tag data to the service terminal. The service terminal sends this data along with the terminal ID and scanner location to the store server. The store server then sends the request on to the manufacturer server, which performs authentication (either itself or via a third party authentication server) and determines the object status. The response is then sent back to the store server, and on to the operator service terminal.

**[0462]** The interaction detail for off-line product scanning at a retailer is shown in FIG. 46. The store operator scans the

Hyperlabel tagged product. The scanner sends the scanner ID and tag data from multiple tags to the service terminal. The service terminal sends this data, along with the terminal ID and scanner location, to the store server. The store server then performs off-line authentication, as described in Section 3.4. 2, and determines the object status through its cached hotlist, valid object ID lists, and public key list. The store server records the scan details in its internal object scanning history. The response is then sent back to the operator service terminal.

**[0463]** An alternative for off-line product scanner occurs where the scanner is a hand-held, stand-alone scanner. In this case the cached authentication data is stored within the scanner itself, and the scanner performs the validation internally. The object scanning history is also cached within the scanner. Periodically the scanner connects to the central database, uploads its object scanning history, and downloads the latest public key list, object ID hotlist and valid ID range list. This connection may be automatic (and invisible to the user), or may be initiated by the user, for example, when the scanner is placed in a docking station/charger.

**[0464]** Product scanning with a netpage pen is illustrated in FIG. 47. When a user scans a Hyperlabel tagged item with their netpage pen, the input is sent to the netpage System, from the user's netpage pen, in the usual way (A). To scan a product rather than interact with it, the pen can be placed in a special mode. This is typically a one-shot mode, and can be initiated by tapping on a <scan> button printed on a netpage. Alternatively, the pen can have a user-operable button, which, when held down during a tap or swipe, tells the pen to treat the interaction as a product scan rather than a normal interaction. The tag data is transmitted from the pen to the user's netpage base station. The netpage base station may be the user's mobile phone or PDA, or it may be some other netpage device, such as a PC. The input is relayed to the Hyperlabel server (B) and then on to manufacturer server (C) in the usual way. On receipt of the input, the manufacturer server authenticates the object if the manufacturer is the trusted authenticator. Alternatively the manufacturer server passes the data on to the authentication server to verify the object ID and signature (D). The authentication server sends the authentication result back to the manufacturer server (E). The manufacturer server checks the status of the object ID (against its valid ID lists and hotlist), and sends the response to the Hyperlabel server (G). The Hyperlabel server, as part of the netpage system, can know the identity and devices of the user. The Hyperlabel server will relay the manufacturer server's response to the user's phone (G) or Web browsing device (H) as appropriate. If the user's netpage pen has LEDs then the Hyperlabel server can send a command to the user's pen to light the appropriate LED(s) (I,J).

**[0465]** The interaction detail for scanning with a netpage pen is shown in FIG. 48. The netpage pen clicks on the Hyperlabel tagged product. The netpage pen sends the pen id, the product's tag data and the pen's location to the Hyperlabel server. If the pen ID is not already associated with a scanner, the Hyperlabel server may create a new scanner record for the pen, or may use the pen ID as a scanner ID. The Hyperlabel server sends the scanner ID, tag data, and scanner location (if known) to the manufacturer server, which performs authentication (either itself or via a third party authentication server)

and determines the object status. The response is then sent back to the Hyperlabel server, and on to the user's default Web browsing device.

#### Security Tagging and Tracking Object Model

**[0466]** The Security Tagging and Tracking object model revolves around Hyperlabel tags, object IDs, and signatures. FIG. 60 illustrates the management and organisation of these objects.

**[0467]** As shown in FIG. 49, a Hyperlabel tag comprises a tag type, object ID, two-dimensional position and a signature fragment. The tag type indicates whether this is a tag on a common object, or whether the tag is on a special type of object such as a currency note or a pharmaceutical product. A signature fragment has an optional fragment number which identifies the fragment's place within the full signature.

**[0468]** As described above, a product's unique item ID may be seen as a special kind of unique object ID. The Electronic Product Code (EPC) is one emerging standard for an item ID. An item ID typically consists of a product ID and a serial number. The product ID identifies a class of product, while the serial number identifies a particular instance of that class, i.e. an individual product item. The product ID in turn typically consists of a manufacturer number and a product class number. The best-known product ID is the EAN.UCC Universal Product Code (UPC) and its variants. The Item ID class diagram is shown in FIG. 50.

**[0469]** Currency notes are identified by a note ID. The note ID comprises note data and a serial number. The note data identifies the type of currency, the country of issue, the note denomination, the note side (front or back) and other currency-specific information. There are two note IDs for each physical bank note—one for each side of the printed note. The Note ID class diagram is shown in FIG. 51.

**[0470]** Pharmaceuticals are identified by a pharmaceutical ID. Typically the pharmaceutical ID will be an EPC. A pharmaceutical ID consists of a product ID and a serial number. The product ID in turn typically consists of a manufacturer number and a product class number. The best known product ID for pharmaceutical products is the National Drug Code (NDC), allocated and administered by the US Food and Drug Administration. The Pharmaceutical ID class diagram is shown in FIG. 52.

**[0471]** Object Description, ownership and aggregation class diagram is shown in FIG. 53. This is described in more detail above.

**[0472]** The Object Scanning History class diagram is shown in FIG. 54. An object has an object scanning history, recording each time the scanner scans an object. Each object scanned event comprises the scanner ID, the date and time of the scan, and the object status at the time of the scan, and the location of the scanner at the time the object was scanned. The object status may be valid, stolen, counterfeit suspected, etc. If known, the object owner details may also be recorded.

**[0473]** A scanner has a unique scanner ID, a network address, owner information and a status (e.g. on-line, off-line). A scanner is either a mobile scanner, whose location may vary, or a fixed scanner, whose location is known and constant. A scanner has a current location, comprising the location details and a timestamp. A scanner may be a netpage pen, in which case it will be associated with a netpage Pen record. If a scanner in off-line, it will keep an object scanning

history, and will optionally store a public key list, a valid ID range list and an object ID hotlist. The scanner class diagram is shown in FIG. 55.

**[0474]** The manufacturer, or other central authority, maintains a number of Object ID Hot Lists, each with a unique list ID, and the time the list was last updated. Each hot list comprises a list of suspect object IDs, comprising the object ID, date, time, status (suspected counterfeit, stolen, etc.) and other information. The Object ID Hot List class diagram is shown in FIG. 56.

**[0475]** The manufacturer, or other central authority, maintains a list of valid ID ranges. Each valid object ID range entry in the list comprises the start object ID and end object ID (the valid ID range) and the time the entry was updated. The Valid ID Range List class diagram is shown in FIG. 57.

**[0476]** The manufacturer, or other central authority, maintains a public key list. The public key list consists of a number of entries identifying the public key for a range of Object IDs. Each valid object ID range entry comprises the update time for the entry, the start object ID for the range, the end object ID for the range, and the public key applicable to each object ID in the given range. The Public Key List class diagram is shown in FIG. 58.

**[0477]** Object authentication may be performed by the manufacturer, or by a third-party trusted authenticator. A trusted authenticator has an authenticator ID, name and details. A trusted authenticator holds a list of public-private key pairs, each associated with one or more ID ranges. This is a list of object ID ranges (identified by the start and end ID) and the corresponding public/private signature key pair. A trusted authenticator also holds a list of secret signatures, and a list of public-key signatures. Each public-key signature identifies the actual signature and/or the padding used to generate the signature. Each secret signature and public-key signature is associated by object ID with a unique object. The Trusted Authenticator class diagram is shown in FIG. 59.

Applications

**[0478]** It will be appreciated that Hyperlabel tags can be used with a range of objects, including, for example, items of manufacture, pharmaceutical items, currency notes, cheques, credit or debit cards, redeemable tickets, vouchers, coupons, lottery tickets instant win tickets, or identity cards or documents, such as a driver's licenses or passports.

**[0479]** The identity can include at least one of an Electronic Product Code (EPC), a National Drug Code (NDC) number, a serial number of a pharmaceutical item, a currency note attribute such as a value or the like, a cheque attribute or a card attribute such as card type, issuing institution, account number, issue date, expiry date or limit.

Advantages of Hyperlabel

**[0480]** Unlike 2D optical barcodes that are often difficult to read due to label damage and a direct 'line-of-sight' requirement needed for scanning, optically readable, but invisible, infrared Hyperlabel tags, are printed all over, or on a large section of a product label. Hyperlabel tags support line-of-sight omnidirectional reading. In practice, the Hyperlabel reader is designed to scan the scanning field from at least two substantially orthogonal directions. This helps the reader to avoid occlusions which may occur if a hand is holding an item. Hyperlabel tags also incorporate Reed-Solomon error correction methods to improve reliability.

**[0481]** A further advantage of Hyperlabels over barcodes is that they are unobtrusive to the customer as they do not use visible label space, and tag information is not restricted to only one section of a label.

**[0482]** Hyperlabel tags are therefore easy to locate, easy to read, and enable accurate automatic scanning.

**[0483]** Hyperlabels are less promiscuous than RFID tags since they require line-of-sight for reading. This means that it will be difficult for customers to have their product scanned for information without their knowledge. Hyperlabels provide customers with the means to protect their privacy.

Hyperlabels as Interactive Web Pages

**[0484]** A distinctive and unique feature of Hyperlabel technology is that Hyperlabels provide the opportunity to design packaging labels as interactive 'Web pages'—and thus make it possible for a whole new range of product-linked customer services to be introduced by the pharmaceutical industry.

**[0485]** When digital pen use becomes widespread, product graphics can be added to labels to indicate interactive areas and prompting customers to write or click using a Netpage pen. A digital Netpage pen can identify the x-y position on a label, and enable a link to be established between the information on the label, and a Web page on a server. The Netpage pen connects the customer to an Internet-based Hyperlabel Server through a companion device such as a mobile phone or computer.

**[0486]** Using a Netpage pen to interact with the label, customers can be offered additional information on drug use, risks and advice on potential interactions between drugs. It could also provide an opportunity for customers to register for participation in new drug trials, to enter promotions, to participate in Web chat sessions, or to receive 'free' samples. Web pages can be customised based on customer profiles, local area health data, or by using a range of product supply chain data such as geographic location.

**[0487]** Hyperlabels therefore make it possible for the pharmaceutical industry to extend the use of product labels and packaging to increase brand strength, and to establish closer links with customers. Thus, with Hyperlabels, the customer can become an integral part of the product supply chain, and supply chain data can be integrated with customer relationship management (CRM) or healthcare databases to improve the overall efficiency and level of service offered to customers.

We claim:

1. A method of authenticating an object, the method including steps of:

- receiving indicating data, the indicating data being generated in response to sensing of a coded data portion provided on or in a surface associated with the object, the indicating data being indicative of:
  - an identity;
  - a position of the coded data portion; and
  - a fragment of a signature, the signature being a digital signature of at least the identity, and comprising a plurality of signature fragments;
- determining from the indicating data, a received identity, a received signature fragment and the position of the coded data portion;
- determining, using the position, a received signature fragment identifier;
- determining, using the received identity, a determined signature;

determining, using the determined signature and the received signature fragment identifier, a determined signature fragment;  
 comparing the determined signature fragment to the received signature fragment; and  
 authenticating the object using the result of the comparison.

2. A method according to claim 1, wherein the method includes further steps of:  
 generating authentication data indicative of success or failure of the authentication; and  
 transferring the authentication data to a user.

3. A method according to claim 1, wherein the digital signature includes at least one of:  
 a random number associated with the identity;  
 a keyed hash of at least the identity;  
 a keyed hash of at least the identity produced using a private key, and verifiable using a corresponding public key;  
 cipher-text produced by encrypting at least the identity;  
 cipher-text produced by encrypting at least the identity and a random number; and,  
 cipher-text produced using a private key, and verifiable using a corresponding public key.

4. A method according to claim 1, wherein the identity includes the identity of at least one of:  
 the object;  
 the surface; and  
 a region of the surface.

5. A method according to claim 1, wherein each coded data portion is arranged in accordance with at least one layout having n-fold rotational symmetry, where n is at least two, the layout including n identical sub-layouts rotated 1/n revolutions apart about a centre of rotation, at least one sub-layout including rotation-indicating data that distinguishes that sub-layout from each other sub-layout.

6. A method according to claim 1, wherein each coded data portion is arranged in accordance with at least one layout having n-fold rotational symmetry, where n is at least two, the layout encoding orientation-indicating data comprising a sequence of an integer multiple m of n symbols, where m is one or more, each encoded symbol being distributed at n locations about a centre of rotational symmetry of the layout such that decoding the symbols at each of the n orientations of the layout produces n representations of the orientation-indicating data, each representation comprising a different cyclic shift of the orientation-indicating data and being indicative of the degree of rotation of the layout.

\* \* \* \* \*