



(72) COOPER, RANDOLPH A., US
(72) IDEKER, RAYMOND E., US
(71) UAB RESEARCH FOUNDATION, US

(51) Int.Cl.⁶ A61N 1/39

(30) 1997/10/14 (08/950,341) US

(54) **APPAREIL DE DEFIBRILLATION AURICULAIRE AU MOYEN
DE DEUX IMPULSIONS DE CHOC**

(54) **DUAL SHOCK ATRIAL DEFIBRILLATION APPARATUS**

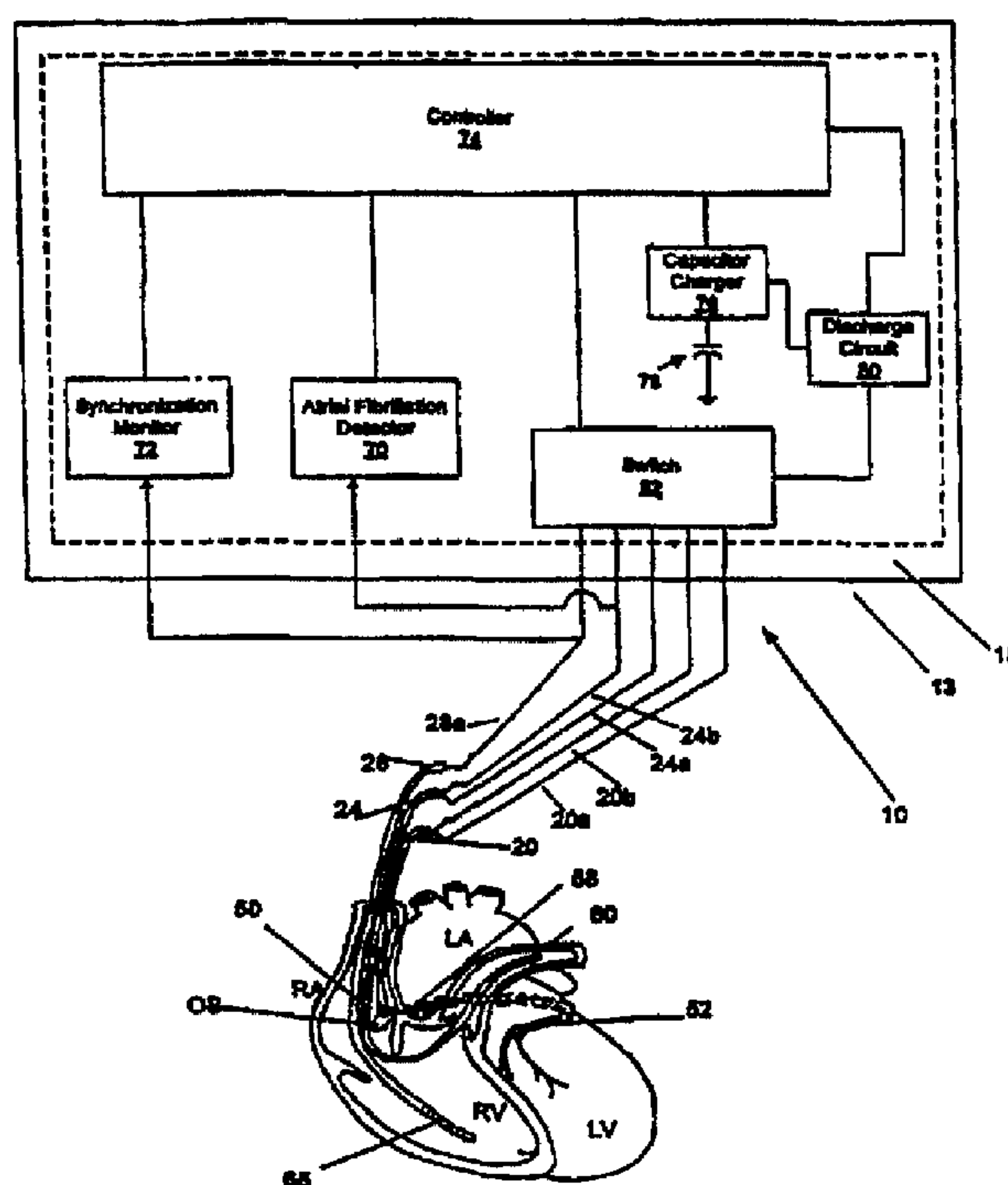

(57) Ce système implanté de défibrillation des oreillettes du coeur d'un patient comprend une paire d'électrodes de défibrillation auriculaire (60, 65), ainsi qu'un générateur d'impulsions (13) associé de manière fonctionnelle à une première paire d'électrodes de défibrillation auriculaire, destinées à fournir la première impulsion de défibrillation auriculaire. Le générateur d'impulsions fournit une seconde impulsion de défibrillation auriculaire, après la première et sans qu'intervienne un contrôle de l'efficacité de cette première impulsion, afin de diminuer la tension nécessaire au choc et par conséquent la douleur associée à celui-ci.

(57) An implanted system for the defibrillation of the atria of a patient's heart includes a pair of atrial defibrillation electrodes (60, 65), and a pulse generator (13) operatively associated with the first pair of atrial defibrillation electrodes for delivering the first atrial defibrillation pulse. The pulse generator delivers a second atrial defibrillation pulse after the first defibrillation pulse without intervening monitoring thereof to reduce the voltage necessary for the shock, and the pain associated therewith.



PCT

WORLD INTELLECTUAL PROPERTY ORGANIZATION
International Bureau

INTERNATIONAL APPLICATION PUBLISHED UNDER THE PATENT COOPERATION TREATY (PCT)

<p>(51) International Patent Classification ⁶ : A61N 1/39</p>	<p>A1</p>	<p>(11) International Publication Number: WO 99/19021 (43) International Publication Date: 22 April 1999 (22.04.99)</p>
---	------------------	--

(21) International Application Number: PCT/US98/21612
 (22) International Filing Date: 14 October 1998 (14.10.98)
 (30) Priority Data: 08/950,341 14 October 1997 (14.10.97) US
 (71) Applicant: UNIVERSITY OF ALABAMA AT BIRMINGHAM RESEARCH FOUNDATION [US/US]; Suite 1120G, 701 South 20th Street, Birmingham, AL 35294-0111 (US).
 (72) Inventors: COOPER, Randolph, A.; 3645 Brookwood Road, Birmingham, AL 35223 (US). IDEKER, Raymond, E.; 76 Arlington Court, 2600 Arlington Avenue South, Birmingham, AL 35205 (US).
 (74) Agents: SIBLEY, Kenneth, D. et al.; Myers, Bigel, Sibley & Sajovec, P.A., P.O. Box 37428, Raleigh, NC 27627 (US).

(81) Designated States: CA, JP, European patent (AT, BE, CH, CY, DE, DK, ES, FI, FR, GB, GR, IE, IT, LU, MC, NL, PT, SE).
 Published
 With international search report.

(54) Title: DUAL SHOCK ATRIAL DEFIBRILLATION APPARATUS

(57) Abstract

An implanted system for the defibrillation of the atria of a patient's heart includes a pair of atrial defibrillation electrodes (60, 65), and a pulse generator (13) operatively associated with the first pair of atrial defibrillation electrodes for delivering the first atrial defibrillation pulse. The pulse generator delivers a second atrial defibrillation pulse after the first defibrillation pulse without intervening monitoring thereof to reduce the voltage necessary for the shock, and the pain associated therewith.

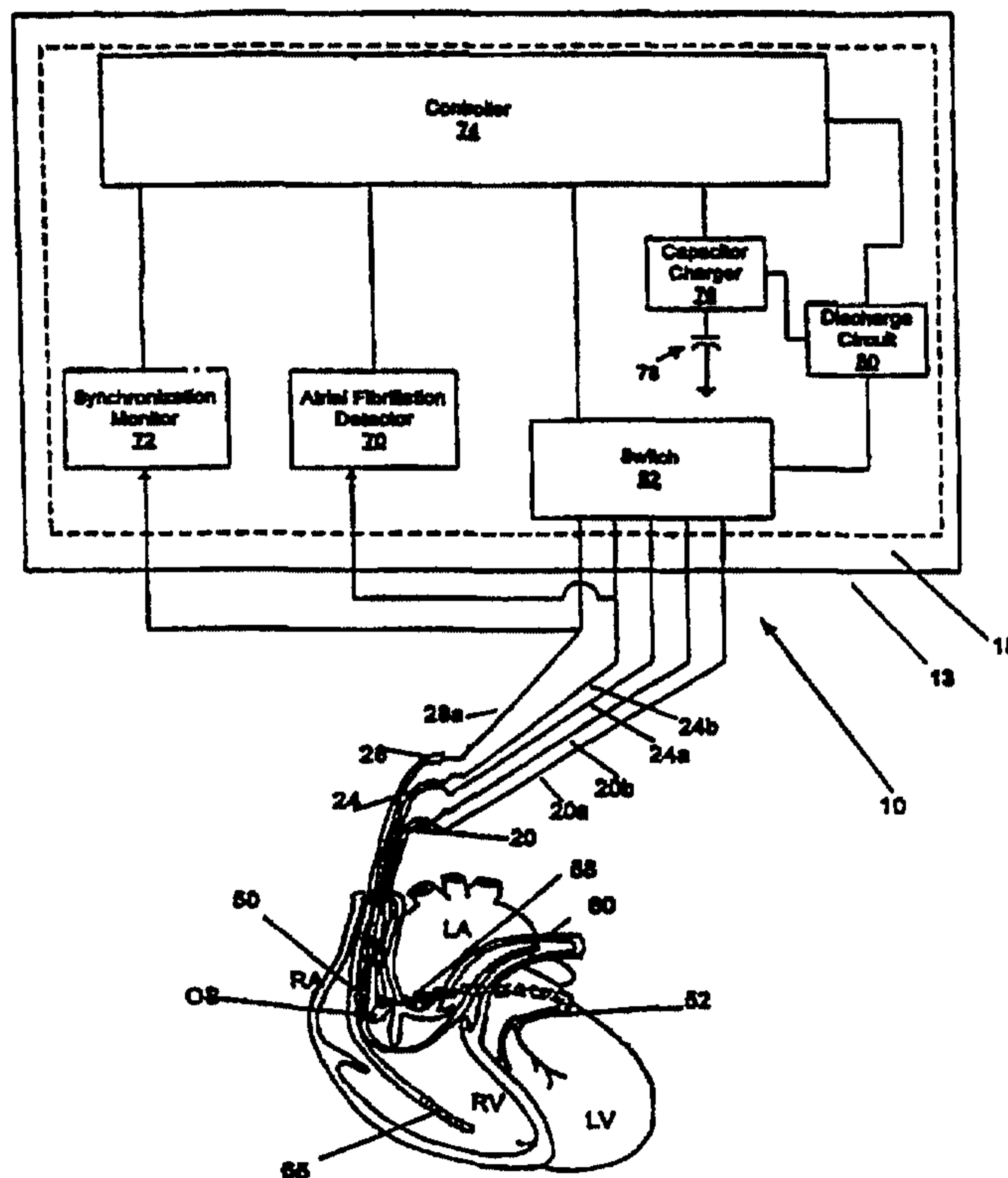

**DUAL SHOCK ATRIAL
DEFIBRILLATION APPARATUS**

5

Field of the Invention

The present invention relates to atrial defibrillation methods and apparatus in which at least two atrial defibrillation pulses are sequentially delivered. In one method, the sequential pulses are delivered along different current pathways. In another method, the sequential pulses are delivered along the same current pathways.

10

Background of the Invention

Atrial fibrillation is one of the most common cardiac arrhythmia. Health consequences associated with atrial fibrillation include decreased cardiac output, less regular ventricular rhythm, the formation of blood clots in the atria and appendages, and an increased incidence of stroke. While some drugs are available for the treatment of atrial fibrillation, they have a number of side effects which reduce their therapeutic utility.

15

Unlike patients afflicted with ventricular fibrillation, patients afflicted with atrial fibrillation are conscious. The pain associated with the administration of the defibrillation shock can be severe, and there is a need for means of carrying out atrial defibrillation in a manner that is less painful to the patient being treated.

20

U.S. Patent No. 5,165,403 to R. Mehra discloses an implantable lead system useful for defibrillating (or "cardioverting") the atria of a patient's heart. In the disclosed system, one electrode is positioned in either the great cardiac vein or

25

coronary sinus of the heart, and another electrode is positioned in either the right atrium or superior vena cava of the heart. Configurations for reducing the pain associated with defibrillation are not disclosed.

U.S. Patent No. 5,209,229 to Gilli discloses an implantable atrial
5 defibrillation device employing multiple implantable electrodes. Upon detection of atrial fibrillation, a first electrode configuration is selected and a defibrillation shock administered. If atrial fibrillation remains after that shock, then a second electrode configuration is selected and a second defibrillation shock administered. Multiple defibrillation pulse administrations are only used when the
10 initial defibrillation pulse fails, and not as a means to reduce pain associated with atrial defibrillation.

In view of the foregoing, an object of the present invention is to provide methods and apparatus for carrying out atrial defibrillation that will reduce the pain associated therewith.

15 A further object of the present invention is to provide methods and apparatus for carrying out atrial defibrillation that will reliably treat atrial fibrillation.

A still further object of the present invention is to provide methods and apparatus for treating atrial fibrillation that minimizes the extent of the surgical
20 intervention involved in implanting the necessary defibrillation electrodes, and minimizes the complexity involved in implanting the necessary defibrillation electrodes.

Summary of the Invention

25 An implantable system for the defibrillation of the atria of a patient's heart is described herein. The system includes a first pair of atrial defibrillation electrodes configured for delivering a first atrial defibrillation pulse along a first current pathway in the heart, and a pulse generator operatively associated with the first pair of atrial defibrillation electrodes for delivering the first atrial defibrillation
30 pulse. A second pair of atrial defibrillation electrodes configured for delivering a second atrial defibrillation pulse along a second current pathway in the heart is also included, with the second current pathway being different from the first current

pathway. A pulse generator is operatively associated with the second pair of atrial defibrillation electrodes for delivering the second atrial defibrillation pulse after the first defibrillation pulse.

5 In an alternate system disclosed herein, the system is configured so that the first and second atrial defibrillation pulse are delivered along the same current pathway, through the same pair of electrodes.

10 In both of the foregoing systems, the second defibrillation pulse is delivered without intervening monitoring of the efficacy of the first defibrillation pulse. The present invention thus provides a method of atrial defibrillation by sequentially delivering two atrial defibrillation pulses to the atria of a patient afflicted with atrial fibrillation. The voltage of the pulses and the pain associated therewith is thereby reduced.

15 As will be apparent to those skilled in the art, the first and second pulses described above may be followed by additional pulses if desired. Additional pulses may be along the same or different current pathways, or along the first or second current pathways. The apparatus described herein may be extended to provide for the administration additional pulses in accordance with known techniques.

20 Multiple defibrillation pulses have been used in the treatment of ventricular fibrillation (*see, e.g.*, U.S. Patent No. 5,224,476 to Ideker and Guse and references cited therein). However, patients in ventricular defibrillation are typically unconscious and in an immediate life-threatening condition, and reduction of pain is not a compelling object.

25

Brief Description of the Drawings

Figure 1 illustrates a first embodiment of an implantable defibrillation system of the present invention, where a first catheter carries defibrillation electrodes positioned in the proximal coronary sinus and in the distal coronary sinus, a second catheter carries defibrillation electrodes positioned in the right atrium and in the pulmonary artery, and a third catheter carries a monitoring electrode positioned in the right ventricle.

30

Figure 2 illustrates a second embodiment of the present invention, where a first catheter carries defibrillation electrodes positioned in the proximal coronary sinus and in the distal coronary sinus, a second catheter carries a defibrillation electrode positioned in the pulmonary artery, and a third catheter carries a monitoring electrode positioned in the right ventricle and a defibrillation electrode positioned in the right atrium.

Figure 3 illustrates a third embodiment of the present invention, where a first catheter carries defibrillation electrodes positioned in the proximal coronary sinus and in the distal coronary sinus, a second catheter carries a defibrillation electrode positioned in the right atrium, and a third catheter carries a monitoring electrode positioned in the right ventricle and a defibrillation electrode positioned in the pulmonary artery.

Figure 4 illustrates a fourth embodiment of the present invention, where a first catheter carries defibrillation electrodes positioned in the proximal coronary sinus and in the distal coronary sinus, and a second catheter carries a defibrillation electrode positioned in the right atrium, a monitoring electrode positioned in the right ventricle, and a defibrillation electrode positioned in the pulmonary artery.

Figure 5 illustrates a fifth embodiment of the invention similar to the first embodiment illustrated in Figure 1, except that the defibrillation electrode located on the second catheter and positioned in the pulmonary artery has been eliminated, and a defibrillation electrode has been provided on the surface of the defibrillator.

Figure 6 schematically illustrates the electronic circuitry of an implantable atrial defibrillator of the present invention.

Figure 7A illustrates a decaying exponential waveform that can be used to carry out the present invention. Voltage is given on the vertical axis and time is given on the horizontal axis, with negative voltages being indicated by waveforms below the horizontal axis.

Figure 7B is similar to Figure 7A, and illustrates a stepped input waveform.

Figure 7C is similar to Figure 7A, and illustrates a shaped waveform.

Figure 7D is similar to Figure 7A, and illustrates interleaved waveforms.

Figure 8 is a bar graph illustrating the total delivered energy in Joules (given on the vertical axis) required to achieve atrial defibrillation by various single current pathways (bars "All through "GI") and dual current pathways (bars "HI' through 'IN") in adult sheep. Current pathways are indicated above each bar, with dual current pathways being separated by a comma. "RAap" means right atrial appendage, IIDCS" means distal coronary sinus. "CSOS" means proximal coronary sinus, 'ILPA" means left pulmonary artery, and 'IRV" means right ventricular apex.

Figure 9 schematically illustrates an apparatus for carrying out dual shock, single current pathway atrial defibrillation in adult human patients.

Figure 10 illustrates a shock pair used in conjunction with an apparatus according to Figure 9.

Detailed Description of the Preferred Embodiments

Anatomically, the heart includes a fibrous skeleton, valves, the trunks of the aorta, the pulmonary artery, and the muscle masses of the cardiac chambers (i.e., right and left atria and right and left ventricles) The schematically illustrated portions of the heart 30 illustrated in **Figures 1-5** include the right ventricle "RV" 32, the left ventricle "LV" 34, the right atrium "RA" 36, the left atrium "LA" 38, the superior vena cava 48, the coronary sinus "CS" 42, the great cardiac vein 44, and the coronary sinus ostium or "os" 40.

The driving force for the flow of blood in the heart comes from the active contraction of the cardiac muscle. This contraction can be detected as an electrical signal. The contraction travels in a wave propagation pattern which begins at the cells of the SA node and the surrounding atrial myocardial fibers, and then travels into the atria and subsequently passes through the AV node and, after a slight delay, into the ventricles.

The beginning of a cardiac cycle is initiated by a P wave, which is normally a small positive wave. The P wave induces depolarization of the atria of the heart. The P wave is followed by a cardiac cycle portion which is substantially constant with a time constant on the order of 120 milliseconds ("ms").

The "QRS complex" of the cardiac cycle occurs after the substantially constant portion. The dominating feature of the QRS complex is the R wave which is a rapid positive or negative deflection. The R wave generally has an amplitude greater than any other wave of the cardiac cycle, and has a spiked shape of relatively short duration with a sharp rise, a peak amplitude, and a sharp decline. The R wave is the depolarization of the ventricles and therefore, as used herein, the term "ventricle activations" denotes R waves of the cardiac cycle. The QRS complex is completed by the S wave, which is typically a small deflection that returns the cardiac signal to baseline. Following the S wave, the T wave occurs after a delay of about 250 ms. The T wave is relatively long in duration (e.g., about 150 ms). The cardiac cycle between the S wave and the T wave is commonly referred to as the ST segment. The T wave is a sensitive part of the cardiac cycle during which an atrial defibrillation shock is to be avoided, in order to reduce the possibility of an induced (and often fatal) ventricular fibrillation. The next cardiac cycle begins with the next P wave. The typical duration of a complete cardiac cycle is on the order of about 800 ms.

In overview, an implantable system for the defibrillation of the atria of a patient's heart comprises (a) a first pair of atrial defibrillation electrodes configured for delivering a first atrial defibrillation pulse along a first current pathway in the heart; (b) a pulse generator operatively associated with the first pair of atrial defibrillation electrodes for delivering the first atrial defibrillation pulse; (c) a second pair of atrial defibrillation electrodes configured for delivering a second atrial defibrillation pulse along a second current pathway in the heart, with the second current pathway different from the first current pathway; and (d) a pulse generator operatively associated with the second pair of atrial defibrillation electrodes for sequentially delivering the second atrial defibrillation pulse after the first defibrillation pulse. The electrode pairs may be placed in a variety of different locations, as long as different current pathways for the first and second pulse are thereby achieved. A single electrode may participate in more than one electrode pair, so that, for example, two current pathways are achieved through three defibrillation electrodes. Additional electrodes may be tied together to one member of an electrode pair to provide a single pole, if so desired, and additional

electrodes may be provided for following the first and second shocks with additional shocks.

In one embodiment of the invention, the first pair of atrial defibrillation electrodes comprises a defibrillation electrode positioned in the right atrium or superior vena cava of the heart, and a defibrillation electrode positioned in the distal coronary sinus or great cardiac vein of the heart. The electrodes themselves may be configured for positioning in the indicated location. Numerous alternatives for the second pair of atrial defibrillation electrodes forming a second pathway are possible. For example, the second pair of atrial defibrillation electrodes may comprise:

(A) a defibrillation electrode positioned in the proximal coronary sinus of the heart, and a defibrillation electrode positioned anterior to the left atrium of the heart (e.g., in the left pulmonary artery, or on the external surface of a device implanted subcutaneously in the left thoracic region of the patient);

(B) a defibrillation electrode positioned in the left pulmonary artery of the heart, and a defibrillation electrode positioned in the right ventricle of the heart;

(C) a defibrillation electrode positioned in the distal coronary sinus of the heart, and a defibrillation electrode positioned in the right ventricle of the heart;

(D) a defibrillation electrode positioned in the left pulmonary artery of the heart, and a defibrillation electrode positioned in the right atrium of the heart;

(E) a defibrillation electrode positioned in the left pulmonary artery of the heart, and a defibrillation electrode positioned in the distal coronary sinus of the heart (the electrode positioned in the distal coronary sinus may optionally be tied together with an electrode positioned in the right atrium as one pole);

(F) a defibrillation electrode positioned in the proximal coronary sinus of the heart, and a defibrillation electrode positioned in the right atrium of the heart; or

(G) a defibrillation electrode positioned in the proximal coronary sinus of the heart, and a defibrillation electrode positioned in the distal coronary sinus of the heart (the electrode positioned in the distal coronary sinus may optionally be tied together with an electrode positioned in the right atrium as one pole).

Again, the electrodes may be configured for positioning in the indicated locations, and numerous variations on the foregoing will be readily apparent to those skilled in the art. For example, the first defibrillation pulse could be delivered by the second pair of electrodes indicated above, and the second defibrillation pulse could be delivered by the first pair of electrodes indicated above (in which case the indicated second pair of electrodes serves as the "first pair" and the indicated first pair serves as the "second pair"). In addition, multiple electrodes may be implanted to provide three, four, or five or more different alternative electrode pairs and current paths, and the electrode coupling to the pulse generator switched after implantation of the electrodes to optimize the electrode configuration for a particular patient.

Figure 1 illustrates a first embodiment of an atrial defibrillation system of the instant invention. The atrial defibrillator 10 of Figure 1 includes an implantable housing 13 which contains a hermetically sealed electronic circuit 15. The atrial defibrillator also includes a first catheter 20, a second catheter 24, and a third catheter 28, all of which are insertable into the heart 30 without the need for surgical incision. The term "catheter" as used herein includes "stylet" and is also used interchangeably, with the term "lead". Each of the catheters 20, 24, 28 contain electrode leads 20a, 20b, 24a, 28a, respectively for connecting at least one electrode to the electronic circuit 15 in the housing.

In the embodiment of **Figure 1**, the implantable defibrillation system includes a first defibrillation electrode 50 configured for positioning in the right atrium (R-A) 36 or superior vena cava 48. Also illustrated in sectional view is the interior of the right ventricle (RV) 32, along with the exterior of the left atrium (LA) 38 and the exterior of the left ventricle (LV) 34. A second defibrillation electrode 52 is configured for positioning in the distal coronary sinus (DCS) 42 or great cardiac vein 44. A pulse generator which is part of the electronic circuit 15

enclosed in the implantable housing 13 is connected to and couples the first pair of electrodes 51 (50, 52) via leads 20, 24. Thus, a first pair of electrodes 51 thereby provides a first current pathway 53 for delivering a first atrial defibrillation pulse therebetween.

5 A second pair of electrodes are disposed to provide a second current pathway 55 different from the first current pathway 53. As illustrated in Figure 1, a second pair consisting of a third electrode 58 and a fourth electrode 60. As illustrated, the third electrode 58 is configured for positioning in the proximal coronary sinus (PCS) 42 and the fourth electrode 60 is configured for positioning
10 in the left pulmonary artery (LPA) 45. A second pulse is generated by the pulse generator and delivered via leads 20, 24 to be delivered by the, electrically coupled or paired PCS and LPA electrodes 58, 60.

As illustrated in Figure 1, the first lead 20 in this embodiment comprises an endocardial transvenous elongate lead having electrodes 52 and 58 arranged for
15 establishing electrical communication with the opposing (or paired) electrode as described hereinabove. The lead is typically enclosed in a catheter and flexibly arranged to be fed through the superior vena cava 48, into the right atrium 50, and then into the coronary sinus 40 and advanced into the coronary sinus so that the distal electrode 52 in the distal coronary sinus (DCS) is within the CS adjacent the
20 LV 34 and beneath the LA. or within the great cardiac vein 44 adjacent the left ventricle 34. The proximal CS electrode (described in this embodiment as the third electrode. supra) 58 is spaced apart from the DCS electrode such that when the DCS electrode is properly positioned, the PCS electrode remains in the CS.

The second lead 24 in Figure 1 comprises an endocardial transvenous
25 elongate lead having electrodes 50 and 60 arranged for establishing electrical communication with an opposing or paired electrode to provide an appropriate shock pulse therebetween. As such, the lead is typically enclosed in a catheter and flexibly arranged to be fed into the superior vena cava 48 and advanced into the pulmonary artery 45. The fourth electrode or pulmonary artery electrode is
30 preferably on the tip or tip portion of the lead 24 so as to be insertably positioned in the pulmonary artery adjacent the LA 38. Upon proper placement, the first

10

electrode or PA electrode 50 is spaced on the lead apart from the LPA electrode 60 so that when in place it is positioned in the PA 36 or superior vena cava 48.

Also illustrated in Figure 1 is a fifth electrode 65 configured for positioning in the apex portion of the RV 32. This electrode is typically a monitoring electrode for providing the selected cardiac wave signals, *i.e.*, P, R, or T, via associated lead line 28 to a synchronization monitor 72 and a controller in the electronic circuit 15 which allows the controller 74 to synchronize the delivery of the atrial stimulation pulses in response to the detected cardiac or ventricular signals to minimize the possibility of induced ventricular fibrillation.

Figures 2-4 are similar to Figure 1 above, and illustrate alternate embodiments of lead and electrode placements, where the electrode pairs and relative placement for delivering the stimulation shock pulses remains the same. Like components bear like numbers to Figure 1 above. It will be appreciated by those of skill in the art that the particular leads on which the electrodes are arranged does not affect the electrical coupling of the respective opposing electrode. The electrical coupling is provided by a controller and switch in the electronics circuit (discussed below). In each embodiment it is preferable, but not essential, that the PCS and DCS electrodes remain on the same lead for easier insertion, here shown as the first lead or catheter 20.

Figure 2 illustrates an embodiment of the invention where the second lead or catheter 24' includes the LPA electrode 60 on the distal end, preferably the tip, of the lead. The third lead or catheter 28, includes the RA and RV electrodes 50, 65, positioned proximally and distally respectively.

Figure 3 illustrates a different embodiment of the second and third leads or catheters 24'', 28''. The second catheter 24'' includes proximally positioned RV and distally positioned LPA electrodes 65, 60; the third catheter 28'' includes a RA (or SVC) electrode 50 which is positioned as a distal tip electrode thereof.

Figure 4 illustrates an embodiment which employs only two catheters or leads 20, 24'''. The second lead 24''' includes three electrodes, a distal LPA electrode 60, an intermediate RV electrode 65 and a, proximal RA (or SVC) electrode 50.

Figure 5 is similar to **Figure 1**, but illustrates an alternate embodiment of the LPA electrode **60** as well as alternate lead or catheter configurations. The LPA electrode **60** is replaced by (or in the alternative supplemented with) an electrode comprising an active external portion **60**, of the housing **13**, which is preferably implanted anterior to the left atrium. In this embodiment, the housing electrode **60**, is typically paired with the PCS electrode **58** and is configured to provide a stimulation pulse therebetween as directed by the controller and electronic circuit.

Figure 6 illustrates one example of an implantable housing **13** containing an electronic circuit **15**, which includes one or more amplifiers (not shown) for amplifying sensed cardiac signals. The amplified signals are analyzed by an atrial fibrillation detector **70** which determines if atrial fibrillation is present. The atrial fibrillation detector **70** may be one of several known to those skilled in the art. Although, as illustrated, a sensing signal is provided by the RA electrode **50**, it will be appreciated by those of skill in the art that the sensing electrode may also be a plurality of sensing electrodes with a plurality of signals, such as bipolar configurations, and may also be electrodes that are positioned in alternate cardiac areas as is known in the art, such as for example, the CS. In this situation, the input line to the atrial fibrillation detector may be a plurality of lines which if providing only sensing will provide an input to the detector.

The defibrillation electrodes may alternately be configured to sense cardiac cycles, or may have smaller sensing electrodes placed adjacent thereto and thereby provide input to the electronics package as well as provide a predetermined stimulation shock output to predetermined cardiac areas as directed by the controller.

The electronic circuit **15** also includes a cardiac cycle monitor ("synchronization monitor **72**") for providing synchronization information to the controller **74**. As discussed below, the synchronization is typically provided by sensing cardiac activity in the RV, but may also include other sensing electrodes which can be combined with the defibrillation electrodes or employed separately to provide additional assurance that atrial stimulation shock pulses are not delivered during sensitive portions of the cardiac cycle so as to reduce the possibility of inducing ventricular fibrillation.

Upon a signal from the atrial fibrillation detector 70, the controller 74, in turn, signals a capacitor charging circuit 76 which then charges the storage capacitor 78 to a predetermined voltage, typically from a battery source (not shown). The discharge of the capacitor is controlled by the controller 74 and/or a discharge circuit 80. The controller, based on information from the synchronization monitor 72, typically allows or directs the preselected shock pulse to be relayed to either a discharge circuit for further processing (i.e., to further shape the waveform signal, time the pulse, etc.) or directly to a switch. The controller also typically controls the proper selection of the predetermined defibrillation electrode pair(s) to direct the switch to electrically activate a desired electrode pair to align the predetermined electric shock pulse pathway through which the shock pulse is provided. As an alternative to an atrial defibrillation detector, the defibrillation pulses may be triggered by an external signal administered by a physician, with the physician monitoring the patient for the appropriate time of administration.

As noted above, the instant invention provides two separate shock pulses to two separate current pathways determined by the electrode pair arrangement also as discussed above. Therefore, it will be appreciated by those of skill in the art that the capacitor 78 may be a single capacitor or a bank of parallel capacitors sufficiently charged and sized to be able to provide at least two separate shock pulses to predetermined electrodes positioned in the heart. Additionally, the capacitor 78 can be two or more separately charged capacitors (or bank of parallel capacitors) on separate lines to provide two separate and sequential shock pulses as controlled by the controller 74 and/or the discharge circuit 80. However, it is preferred that the capacitor 78 be a relatively large capacitor for insuring sufficient charge and decay period (i.e., long time constant and low tilt) to provide sufficient energy for two shock pulses. For example, a capacitor with capacitance in the range of 200 - 1000 μ f or more, having an associated time constant in the range of 30 ms, would typically be charged to approximately 100 - 200 volts and would deliver a V (peak) in a typical first waveform of about 50-100 volts leading edge. If additional shocks beyond two are administered, then a larger capacitor may be employed. In the alternative wherein the electronic package employs a circuit to

further shape the waveform, the capacitor may be charged to a higher voltage range (such as around 200 V).

In one embodiment of the invention, the pulse generator includes a single capacitor 78, and the controller 74 includes a switch (e.g., a crosspoint switch) operatively associated with that capacitor. The switch is configured to provide a biphasic pulse (i.e., a first phase of a pulse of a predetermined polarity followed by a second phase of a pulse of reversed polarity) as the first atrial defibrillation pulse and a biphasic pulse as the second atrial defibrillation pulse.

The controller 74 delivers a preselected electrical pulse to predetermined electrode pairs through a switch 82 which is preferably programmable. The capacitor charger 76, capacitor 78, controller 74, discharge circuit 80 and switch 82 thus form an electrical pulse generator. Therefore, it will be appreciated that in operation, in response to an input from the atrial fibrillation detector 70, the controller 74 controls the pulse generator to synchronize the delivery of the timed pulse output to the proper electrode pair in accordance with the cardiac cycle information received from the synchronization monitor 72 and the specific electrode configuration employed by the device. Further, when employing a biphasic waveform, it will be appreciated by those of skill in the art that the pulse generator also includes a crosspoint switch to switch the polarity of the electrode pair for delivery of the second (inverted or negative) waveform phase. It is also preferable that the electronic package include a receiver/transmitter coupled to the internal controller 74 for communicating with an external controller. Thus the pulse regimen could be altered by external input to the controller to alter for example, the waveform, the voltage, the electrode coupling, or even to retrieve data monitoring data received and stored in memory about the number of atrial fibrillation episodes and the effectiveness of the shock level.

In one embodiment of the invention, the switch 82 is programmable (e.g., by remote control such as by a radio signal) to alter the coupling of the pulse generator to the atrial defibrillation electrodes. This feature is advantageously employed when multiple electrodes are implanted so that the electrode pairs that deliver the first and second atrial defibrillation pulses may be changed to optimize the technique for a particular patient.

The energy of the first atrial defibrillation pulse is preferably not greater than 8 joules, more preferably not greater than 6 joules, still more preferably not greater than 4 joules, and most preferably not greater than 2 joules. The energy of the second atrial defibrillation pulse is typically not greater than the energy of the first defibrillation pulse (although such a result is possible where a dual capacitor design is employed), and is preferably not greater than 8 joules, more preferably not greater than 6 joules, still more preferably not greater than 4 joules, and most preferably not greater than 2 joules. The second atrial defibrillation pulse preferably follows the first atrial defibrillation pulse by 0 to 500 milliseconds, and more preferably follows the first atrial defibrillation pulse by 0 to 200 milliseconds. In the alternative, the second atrial defibrillation pulse may overlap the first atrial defibrillation pulse, for example by from one fourth to three fourths of the total shock duration (the duration of both shocks in series). The duration of each shock may be, for example, from three to twenty milliseconds, with total shock duration being, for example, from four and one half to forty milliseconds.

Figures 7A through 7D illustrate exemplary waveforms that can be used to carry out the present invention. Voltage is given on the vertical axis and time is given on the horizontal axis of each figure. The particular waveform of the defibrillation pulse is not critical, and any waveform can be used. The typical voltage waveform delivered by a capacitor is a decaying exponential waveform **54**, **56** with the leading edge voltage of the second pulse V_{L2} being less than or equal to the trailing edge voltage V_{T1} of the first pulse and such a waveform is illustrated in **Figure 7A**. As illustrated, the first pulse waveform **54** is a biphasic asymmetric waveform with a longer first phase and a shorter second phase: for example, a 5-15 millisecond (ms) first phase, and a 2-10 ms second phase. More preferably, the biphasic waveform is about a 3 ms/1ms pulse waveform.

Alternatively, symmetrical waveforms having approximately equivalent first and second phase pulse segment duration times such as 3ms/3ms, monophasic waveforms or even reverse biphasic asymmetrical waveforms, or combinations of waveforms are also suitable. Further illustrated in Figures 7A and 7B, the second waveform **56**, **56**, are also asymmetric biphasic waveforms and along the same time duration as discussed for the first waveform **54**. The waveforms may be

15

stepped input waveforms 54',56', as illustrated in Figure 7B. The waveforms may be shaped, as illustrated by waveforms 54'', 56'' in Figure 7C. Monophasic waveforms can be employed as either a first, second (see Figure 7C) or even both pulse waveforms. The phases of biphasic waveforms may be separated in time by, for example, 0 to 200 ms. Additionally, the waveforms may be interleaved as illustrated in Figure 7D, for example to sequentially provide a first pulse phase 54a to a first electrode pair such as a right atrium (PA) to distal coronary sinus (DCS) electrode pair, a second waveform 56a first phase to the second electrode pair such as a proximal coronary sinus (PCS) to left pulmonary artery LPA electrode pair, a first waveform second phase 54b to the first electrode pair, and then a second waveform second phase 56b to a second electrode pair. As will be appreciated by those skilled in the art, the shock sequence can be altered in any number of ways and still equivalently function in the manner intended herein.

In overview, an implantable atrial defibrillator for use in a system for the defibrillation of the atria of a patients heart by a first and second pair of atrial defibrillation electrodes comprises an implantable housing: an atrial fibrillation detector contained within the housing; and a pulse generator contained within the housing and operatively associated with the atrial fibrillation detector. The housing may be fabricated of any suitable biocompatible materials known to those skilled in the art. A power supply such as a battery operably associated with the pulse generator is typically contained within the housing. The pulse generator is configured for delivering a first atrial defibrillation pulse across the first pair of atrial defibrillation electrodes upon the detection of atrial fibrillation; and the pulse generator is configured for delivering a second atrial defibrillation pulse across the second pair of atrial defibrillation electrodes after the first defibrillation pulse. In one, preferred embodiment, a subcutaneous electrode is located on the external surface of the housing of the implantable atrial defibrillator, as described in G. Bardy, U.S. Patent No. 5,292,338 (the disclosure of which is incorporated by reference herein in its entirety). The defibrillator is then implanted in the left thoracic region of the patient (e.g., subcutaneously, in the left pectoral region) in accordance with known techniques, again as described in G. Bardy, U.S. Patent

No. 5,292,338. The implantable defibrillator may be used in combination with known leads or leads as described herein to provide a system as described herein.

One lead for insertion into the heart of a patient for use in combination with an atrial defibrillator of the present invention comprises an elongate catheter flexibly configured for insertion down the superior vena cava of the heart, into the right atrium, through the opening of the coronary sinus, through the proximal coronary sinus and into the distal coronary sinus or great cardiac vein of the heart to achieve an operable configuration therein; a first atrial defibrillation electrode connected to the catheter; and a second atrial defibrillation electrode connected to the catheter. The first and second atrial defibrillation electrodes are spaced apart on the catheter so that, when the catheter is in the operable configuration, the first atrial defibrillation electrode is positioned in the distal coronary sinus or great cardiac vein of the heart, and the second atrial defibrillation electrode is positioned in the proximal coronary sinus of the heart.

Another lead for insertion into the heart of a patient for use in combination with an atrial defibrillator of the present invention comprises an elongate catheter flexibly configured for insertion down the superior vena cava of the heart, into the right atrium, through the right ventricle, and into the pulmonary artery to achieve an operable configuration therein; a first atrial defibrillation electrode connected to the catheter; and a second atrial defibrillation electrode connected to the catheter. The first and second atrial defibrillation electrodes are spaced apart on the catheter so that, when the catheter is in the operable configuration, the first atrial defibrillation electrode is positioned in the right atrium of the heart and the second atrial defibrillation electrode is positioned in the pulmonary artery. The lead may also include a third electrode connected to the catheter, with the third electrode spaced apart from the first and second atrial defibrillation electrodes so that, when the catheter is in the operable configuration, the third electrode is positioned in the left ventricle of the heart. The third electrode may be a monitoring electrode.

Systems as described above may be implanted in a patient by conventional surgical techniques, or techniques readily apparent to skilled surgeons in light of the disclosure provided herein, to provide an implanted atrial defibrillation system.

Additional features can also be added to the invention without affecting the function of the invention and result thereof. Such additional features include, but not limited to, safety features such as noise suppression or multiple wave monitoring devices (R and T), verification checking to reduce false positive, precardioversion warning, programmed delayed intervention, bipolar configured sensing electrodes, reducing the amount of charging voltage needed to charge a storage capacitor by "slow charging" and associated circuitry, intermittently activated defibrillation detector to reduce energy drain, a switching unit to minimize lines from the pulse generator, etc.

Although the atrial defibrillator has been described above as an implantable defibrillator, it will be appreciated by those of ordinary skill in the art that the invention could also be incorporated into an external, atrial defibrillator which employs catheters to position the electrodes for a short time within a patient's heart. The external defibrillator could be of use for one-time cardioversion of atrial fibrillation or for patients who develop atrial fibrillation post-surgery.

Dual shock or dual pulse, single current pathway methods, systems, and apparatus are carried out in essentially the same manner as described above, with the system modified so that the second shock is delivered through the same pair of electrodes as the first shock.

Combination systems in which a dual shock therapy can be given along either a single current pathway or a dual current pathway, can also be provided by adding a switch and appropriate control circuitry operatively associated therewith within the defibrillator housing for switching the system between these two types of treatments. The switch may be externally controllable, or the system may include internal program for selecting the optimum mode of treatment.

The present inventions are explained further in the following non-limiting examples.

EXAMPLE 1**Dual Shock Dual Current Pathway****Atrial Defibrillation in Adult Sheep**

In this Example, as graphically illustrated in **Figure 8** (result H) , a dual
5 current pathway with first electrode pair RA-DCS and second electrode pair CSO,
(PCS, supra)-LPA realized a significant decrease in delivered energy in a sheep
model of atrial fibrillation (AF).

In five adult sheep (heart weight 342 ± 21 gms), AF was induced with rapid
atrial pacing. Transvenous defibrillation electrodes were positioned in the right
10 atrial appendage (RAap), distal coronary sinus (DCS), proximal coronary sinus
(CSos), left pulmonary artery (LPA), and right ventricular apex (RV). Seven
single and seven dual current pathways were compared. A single capacitor
biphasic waveform with the first phase 3 ms in duration and the second phase 1 ms
in duration was delivered through each current pathway. The trailing edge voltage
15 of each preceding first phase was equal to the leading edge voltage of the next
phase. Atrial defibrillation thresholds (ADFT) were determined using a step up
protocol, and probability of success curves were then determined by giving 10
shocks for each waveform starting at the ADFT using an up/down method with a
20 volt step size. The graph shows the electrode configurations and the mean and
standard deviation of the total delivered energy for the 50% success points (E50) .
Dual current pathway "H" has a fourfold lower ESO than the standard single
current pathway "All (0.26 ± 0.18 vs. 1.13 ± 0.23 joules) ; also, pathway "H" had a
significantly lower E50, than all other single and dual electrode configurations
tested. Compared to the single current pathway ("A") being employed with the
25 first implantable atrial defibrillators, atrial defibrillation thresholds can be
markedly reduced by using dual current pathways.

EXAMPLE 2**Dual Shock Single Current Pathway****Atrial Defibrillation in Adult Sheep**

5 This example illustrates that two shocks given in succession through the same set of electrodes requires less leading edge voltage for atrial defibrillation than does a single shock of the same morphology.

Atrial fibrillation was induced in six sheep. Shocks were given via electrodes in the coronary sinus and in the right atrium, essentially as described above. Each shock consisted of a biphasic waveform with the first phase 3
10 milliseconds in duration and the second phase one millisecond in duration. The shocks were given from a defibrillator with a capacitance of 150 microfarads. A single biphasic shock required a mean defibrillation voltage of 162 volts and a delivered energy of 1.3 Joules (1.31 ± 0.36). When two such biphasic shocks were given in succession through the same set of electrodes with a 0.2 msec separation
15 between the shocks and both shocks delivered from the same capacitor bank, the mean leading edge voltage required for defibrillation was 115 volts and a delivered energy of 93 Joules (115 ± 19 and 0.93 ± 0.42).

EXAMPLE 3**Dual Shock Single Current Pathway****Atrial Defibrillation in Adult Humans**

20 The study described in this example illustrates that two shocks given in succession through the same set of electrodes requires less leading edge voltage and energy for atrial defibrillation than does a single shock of the same morphology in adult human patients afflicted with atrial fibrillation.
25

The study is carried out as follows. If the patient is in atrial fibrillation on arrival, then the defibrillation study is performed first. If the patient is in any other rhythm than atrial fibrillation then the diagnostic and/or the therapeutic procedure is performed first, followed by the defibrillation study. Atrial fibrillation must be
30 able to sustain for 5 minutes prior to the start of the study, patients are hooked up to an external defibrillator at all times during the study, and patients are fully sedated during the study.

Each patient is equipped with at least 2 venous sheaths:

(I) via a 7.5 french internal jugula sheathe the 6 french 10 pole ELECATH defib/pace/recording catheter is placed into the coronary sinus as distal as possible and is called the distal coronary sinus electrode (DCS).

5 (II) Via a 6.5 french femoral or second internal jugular sheath a 6 french 10 pole ELECATH defib/pace/recording catheter is positioned with the tip in the right atrial appendage with the body of the electrodes along the lateral right atrium and is called the right atrial appendage shocking electrode (Raap).

10 (III) Via a 6.5 french femoral sheath a 6 french quadrapolar catheter is positioned in the right ventricular apex for sensing and pacing purposes.

All defibrillation electrodes are plugged into a custom pace/defibrillation record box which then has analog outputs to the PRUCKA amplifiers. The RV apical catheter is plugged into the PRUCKA amplifiers for sensing and pacing capabilities.

The defibrillator setup is schematically illustrated in **Figure 9**. Two HVS-02 defibrillators 101, 102 are employed. A Bloom stimulator 103 is used for sensing and synchronization of shocks. A custom built pace/defibrillator/record box (not shown) for dual defibrillation current pathways is used for connections.

20 The HVS-02 Number 1 defibrillator is set to external trigger channel 1 for a single shock; the HVS-02 Number 2 defibrillator is set to an external trigger channel 1 for dual sequential shocks. The Bloom TTL output 1 (104) is connected to the HVS-02 No. 1 trigger 105 (B and C connectors from Bloom to HVS-02); the Bloom TTL output 2 (106) is connected to HVS-02 No. 2 trigger 107 (B and C connectors

25 from Bloom to HVS-02). The Bloom stimulator is set to sense R wave and then output S2 from Channel 1 to the HVS-02 No. 1 and from channel 2 to HVS-02 No. 2. The Sense to S1 delay is 0-1 milliseconds; the S1 to S2 delay will be the duration of the first biphasic waveform (10 milliseconds). Prior to the start of the study loads are connected to both HVS-02 defibrillator outputs and with sensing

30 from the patient the timing of the system as well as the impedance are checked. A waveform analyzer is used along with a voltage divider box so that actual waveform data can be recorded instead of calculated.

Two waveforms are tested, the waveforms being schematically illustrated in **Figure 10**. A single capacitor single biphasic waveform (first shock)(single HVS-02) of 7.5 and 2.5 milliseconds via a single current pathway (RAaap->DCS); and a single capacitor sequential biphasic (first shock then second shock)(Two HVS-02) 7.5 then 2.5 millisecond biphasic followed by a 7.5 then 2.5 millisecond biphasic, both via the single current pathway Raap->DCS. The delay between the two biphasic waveforms is less than 0.2 milliseconds.

Each waveform is tested in random order in each patient by drawing chits. Atrial defibrillation threshold testing is carried out starting at 100 volts for the initial leading edge voltage for the single capacitor waveform, then using an up/down technique of 50 volts until success is achieved. Shock variable data is acquired using the waveform analyzer. The leading edge voltage and current are recorded from the HVS-02 output and delivered energy and mean impedance are calculated for each shock. Data is saved to a file name that identifies the patient number in the patient clinical database. ADFTs are compared between patients and waveforms using analysis of variance (ANOVA) techniques.

Data from 5 adult human patients obtained in accordance with a study program as set forth above is presented in **Table 1** below. Note the lower first leading edge voltage for the dual shock treatment as compared to the single shock treatment for all five patients. In clinical use, it will be appreciated from the data presented in Table 1 that the first shock leading edge voltage is preferably not greater than 400 volts, more preferably not greater than 350 volts, and most preferably not greater than 300 volts.

The foregoing is illustrative of the present inventions, and is not to be construed as limiting thereof. The inventions are defined by the following claims, with equivalents of the claims to be included therein.

Table 1. Human clinical data.

Patient Number	Ra->DCS (150 μ f Single Capacitor)				RA->DCS x2 (150 μ f Single Capacitor)			
	V1L	I1L	R1	Total E (Joules)	V1L	I1L	R1	Total E (Joules)
1	292	5.62	52	4.3	197	3.79	52	3.8
2	350	7.29	48	5.5	230	4.51	51	4.8
3	337	5.81	58	4.7	235	3.92	60	3.7
4	304	5.74	53	4.2	225	4.09	55	4.2
5	412	8.41	49	8.6	308	6.16	50	8.1
Mean	339	6.57	52	5.44	239	4.49	53.6	4.92
Standard Deviation	47.138	1.233	3.937	1.841	41.286	.971	4.037	1.829
Ttest	.00365	.00904	.27176	.33305				

THAT WHICH IS CLAIMED IS:

1. An implantable system for the defibrillation of the atria of a patient's heart, said system comprising:

a pair of atrial defibrillation electrodes configured for delivering a first atrial defibrillation pulse along a first current pathway in said heart;

5 a pulse generator operatively associated with said pair of atrial defibrillation electrodes for delivering a first atrial defibrillation pulse; and then a second atrial defibrillation pulse after said first defibrillation pulse.

2. A system according to claim 1, wherein said first atrial defibrillation pulse is not greater than 8 joules.

3. A system according to claim 1, wherein said second atrial defibrillation pulse is not greater than 8 joules.

4. A system according to claim 1, wherein said second atrial defibrillation pulse follows said first atrial defibrillation pulse by 0 to 500 milliseconds.

5. A system according to claim 1, further comprising:

a monitoring electrode configured for monitoring the electrical activity of the ventricles of said heart, and

5 a controller connected to said monitoring electrode configured for controlling the time of delivery of said first defibrillation pulse.

6. A system according to claim 5, wherein said monitoring electrode is configured for positioning in the right ventricle of said heart.

7. A system according to claim 1, with said pulse generator including a capacitor and a switch operatively associated with said capacitor, said switch configured to deliver a biphasic pulse as said first atrial defibrillation pulse and a biphasic pulse as said second atrial defibrillation pulse.

8. An implantable system for the defibrillation of the atria of a patient's heart, said system comprising:

(a) a pair of atrial defibrillation electrodes configured for delivering a first atrial defibrillation pulse along a first current pathway in said heart, said pair of
5 atrial defibrillation electrodes comprising a first defibrillation electrode configured for positioning in the right atrium or superior vena cava of said heart; and a second defibrillation electrode configured for positioning in the distal coronary sinus or great cardiac vein of said heart; and

(b) a pulse generator operatively associated with said pair of atrial
10 defibrillation electrodes for delivering a first atrial defibrillation pulse, and then a second atrial defibrillation pulse after said first defibrillation pulse.

9. A system according to claim 8, wherein said first atrial defibrillation pulse is not greater than 8 joules.

10. A system according to claim 8, wherein said second atrial defibrillation pulse is not greater than 8 joules.

11. A system according to claim 8, wherein said second atrial defibrillation pulse follows said first atrial defibrillation pulse by 0 to 500 milliseconds.

12. A system according to claim 8, further comprising:
a monitoring electrode configured for monitoring the electrical activity of
the ventricles of said heart, and
a controller connected to said monitoring electrode configured for
5 controlling the time of delivery of said first defibrillation pulse.

13. A system according to claim 12, wherein said monitoring electrode is configured for positioning in the right ventricle of said heart.

25

14. A system according to claim 8, with said pulse generator including a capacitor and a switch operatively associated with said capacitor, said switch configured to deliver a biphasic pulse as said first atrial defibrillation pulse and a biphasic pulse as said second atrial defibrillation pulse.

15. An implantable atrial defibrillator for use in a system for the defibrillation of the atria of a patient's heart by a pair of atrial defibrillation electrodes, said defibrillator comprising:

an implantable housing;

5 an atrial fibrillation detector contained within said housing;

a. pulse generator contained within said housing and operatively associated with said atrial fibrillation detector;

10 said pulse generator configured for delivering a first atrial defibrillation pulse across said first pair of atrial defibrillation electrodes upon the detection of atrial fibrillation; and

said pulse generator configured for delivering a second atrial defibrillation pulse across said pair of atrial defibrillation electrodes after said first defibrillation pulse.

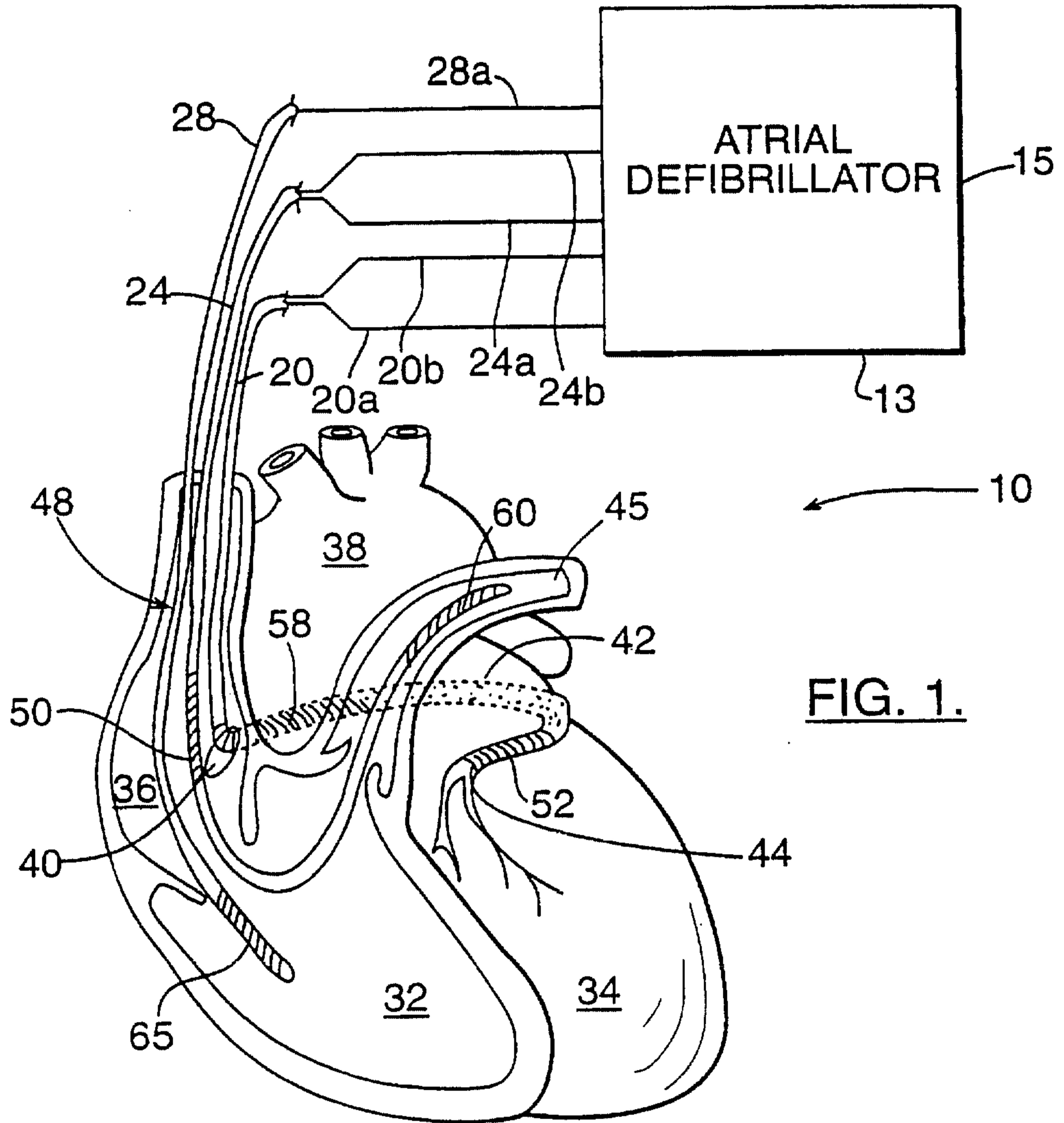

FIG. 1.

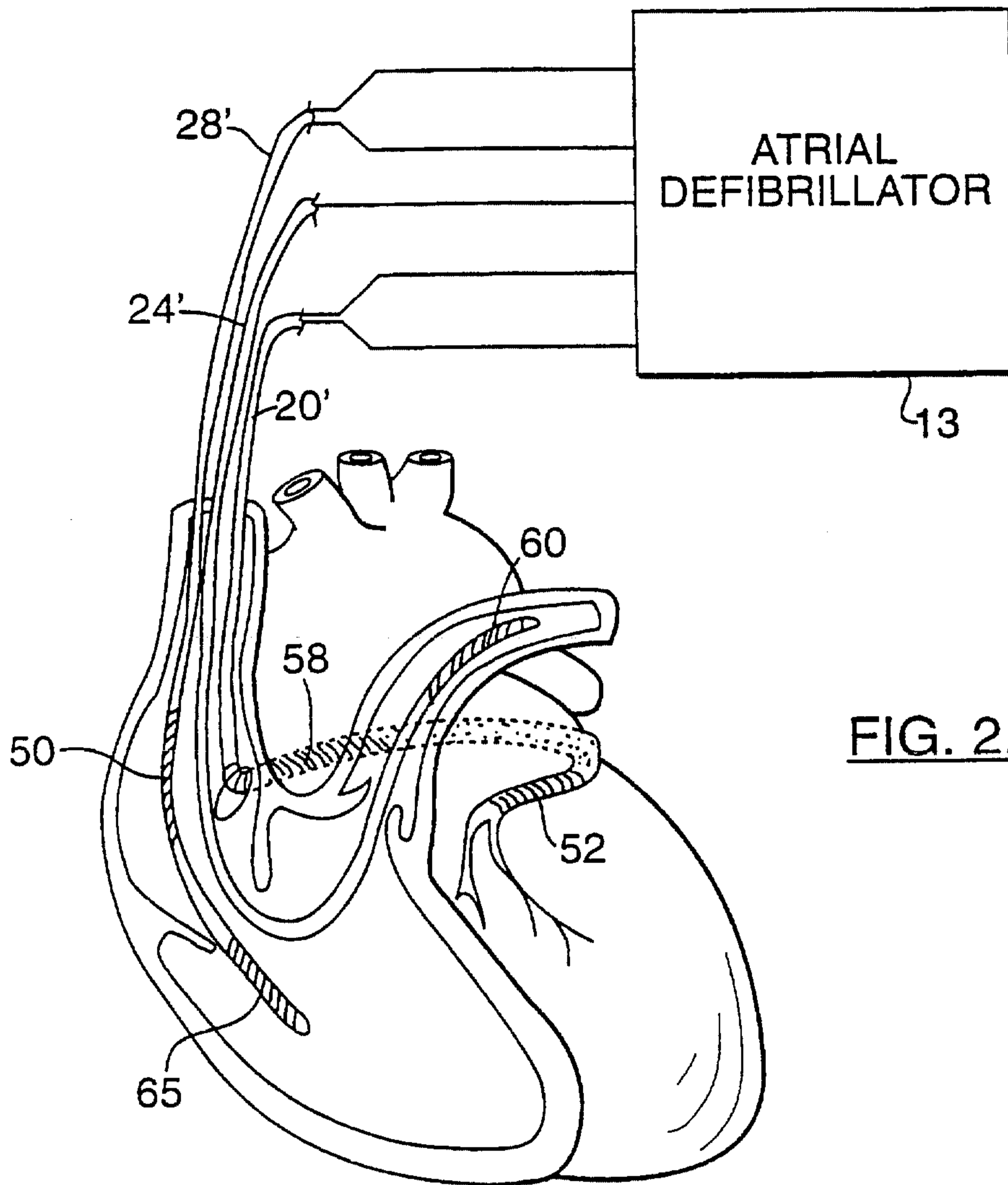

FIG. 2.

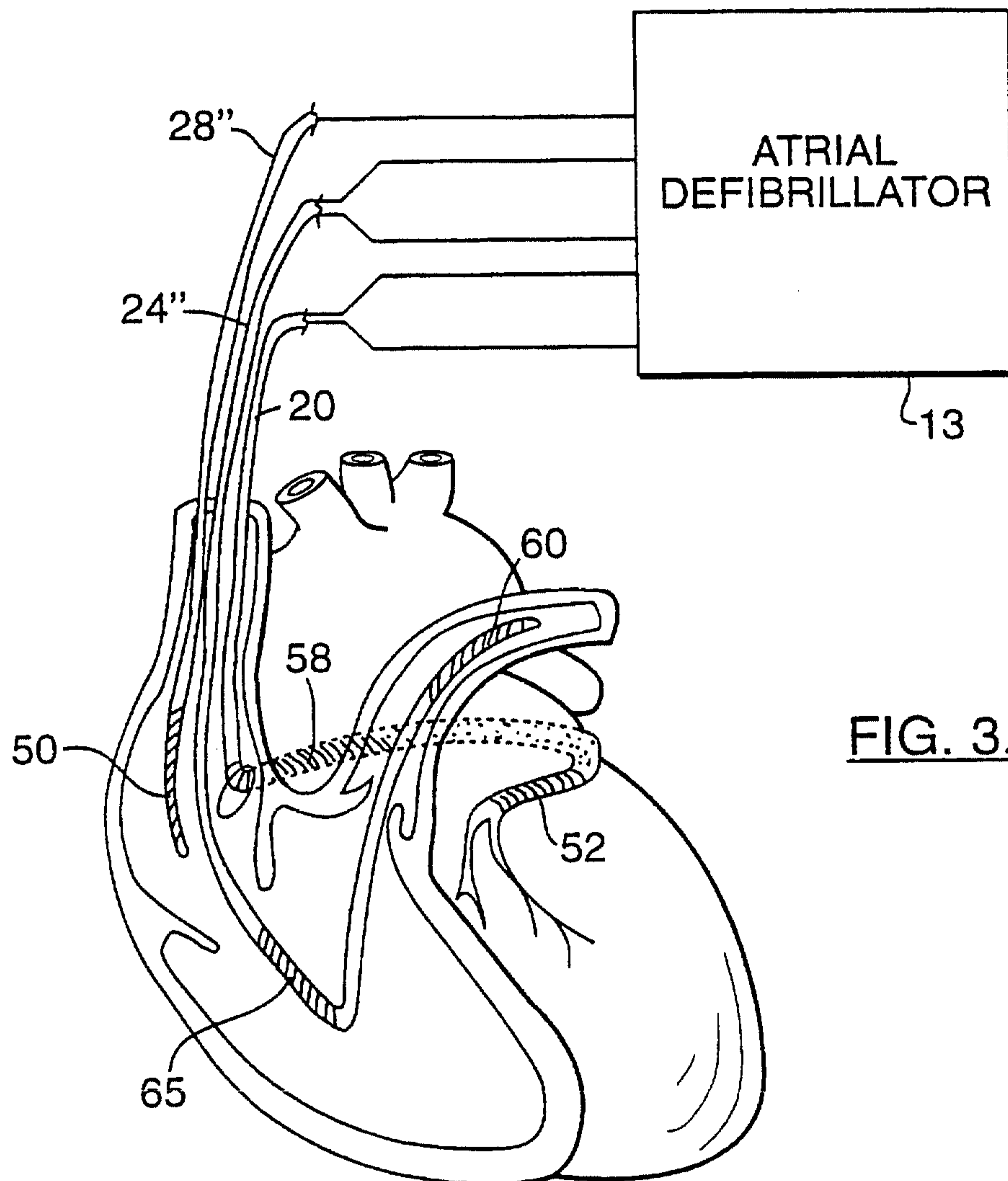

FIG. 3.

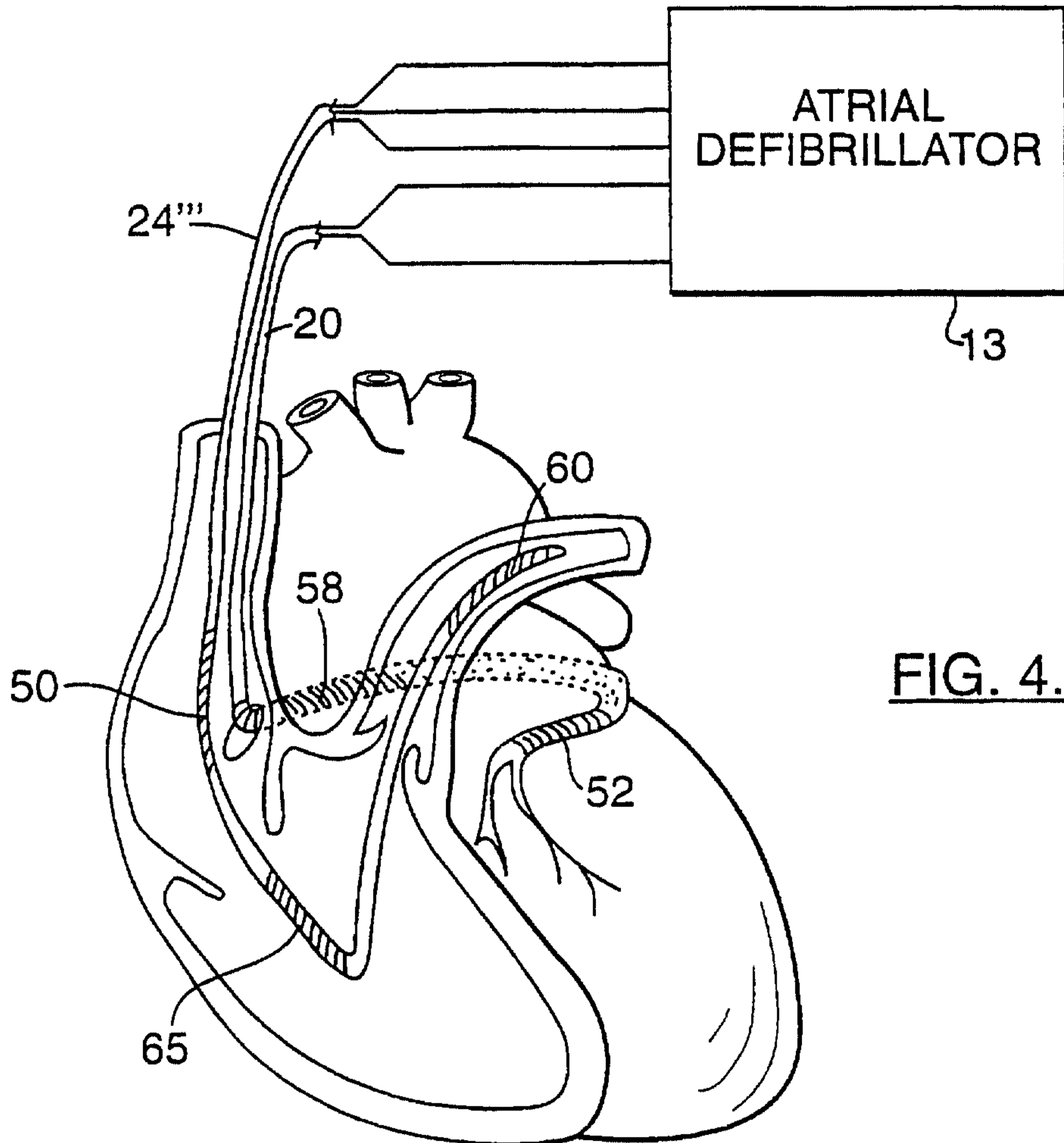

FIG. 4.

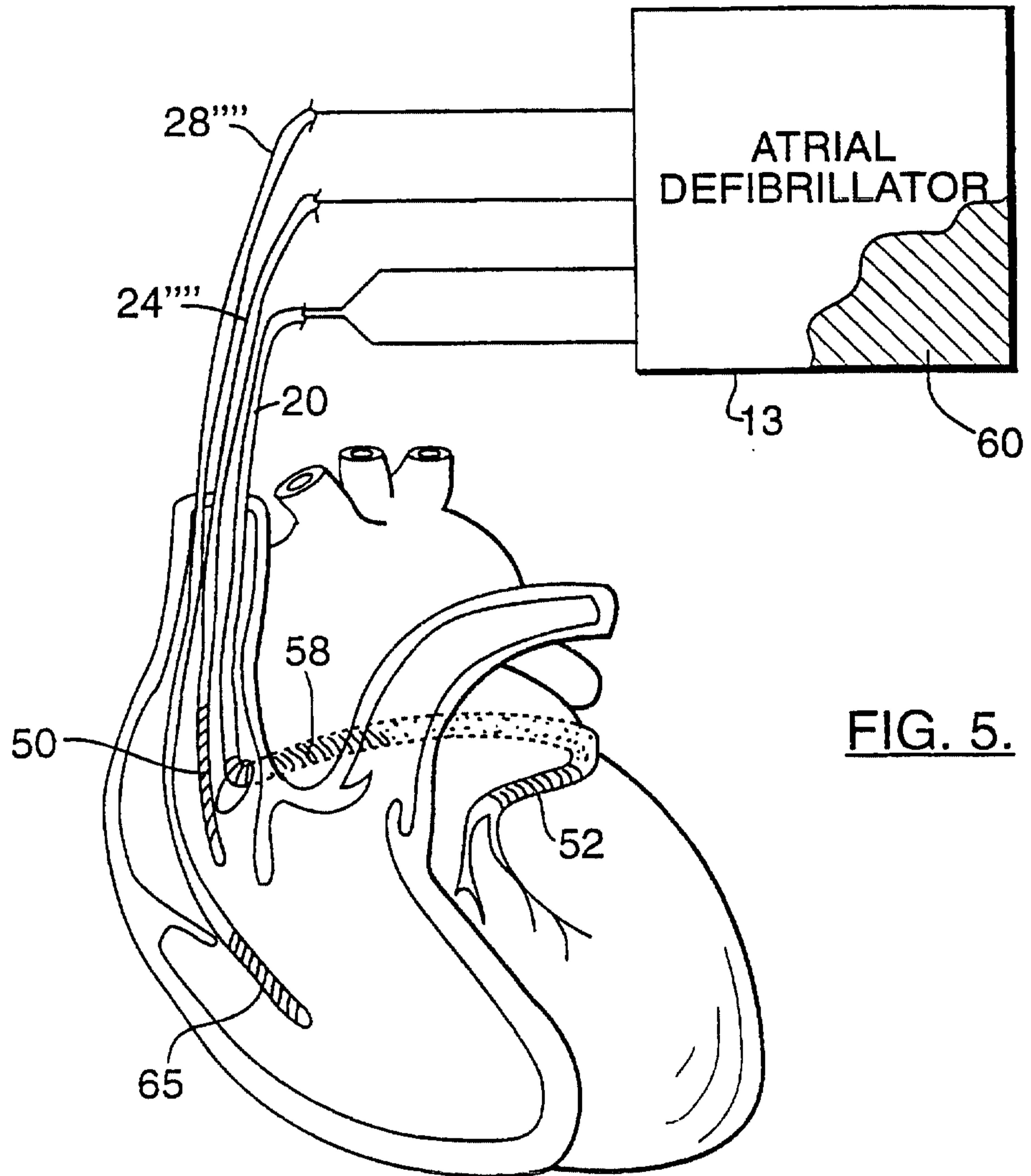

FIG. 5.

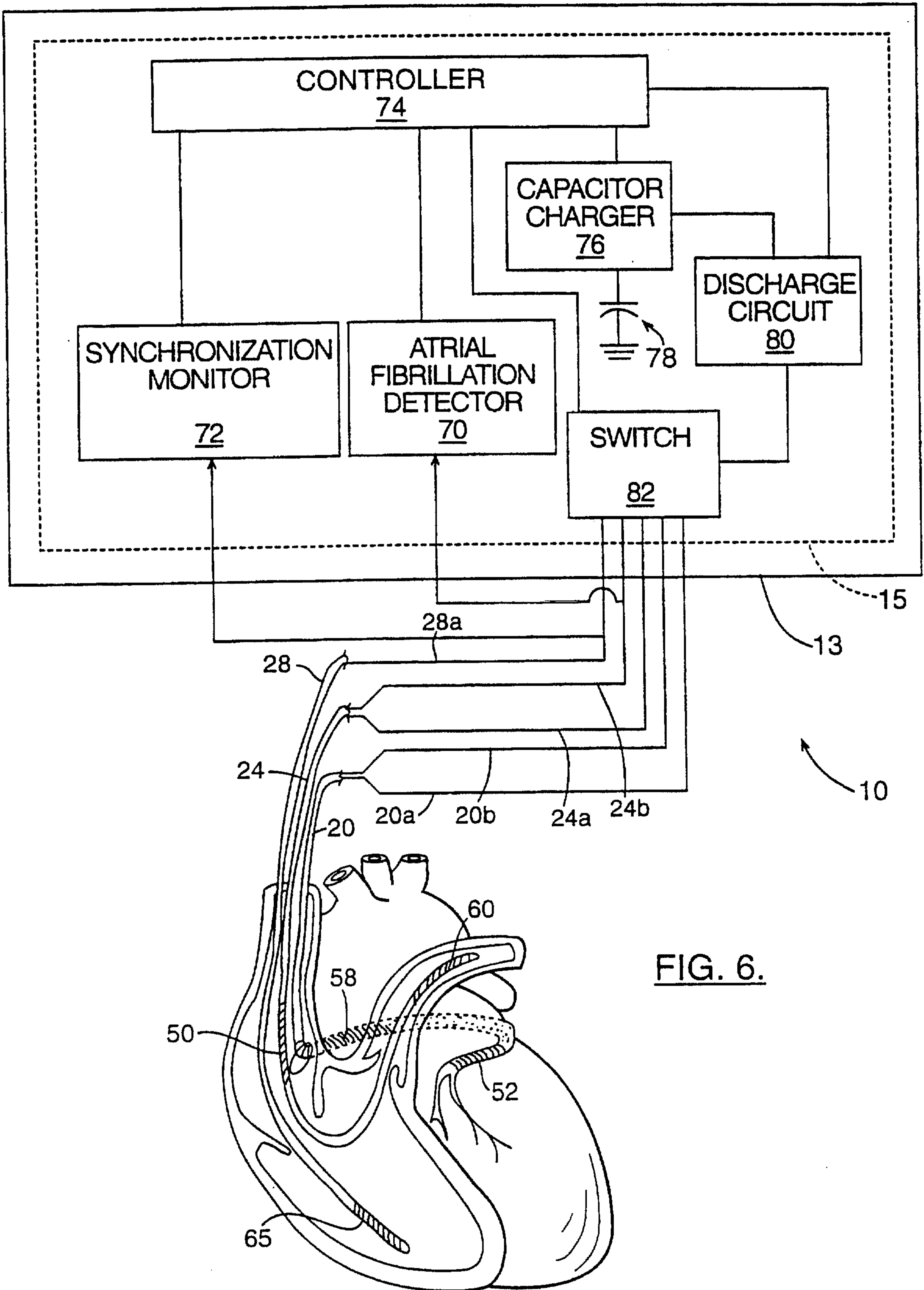
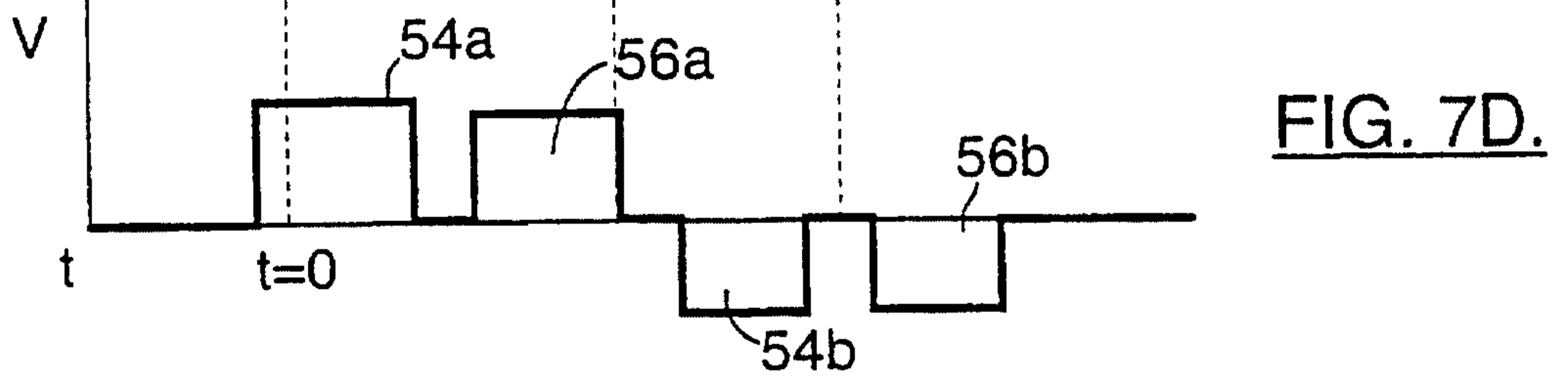
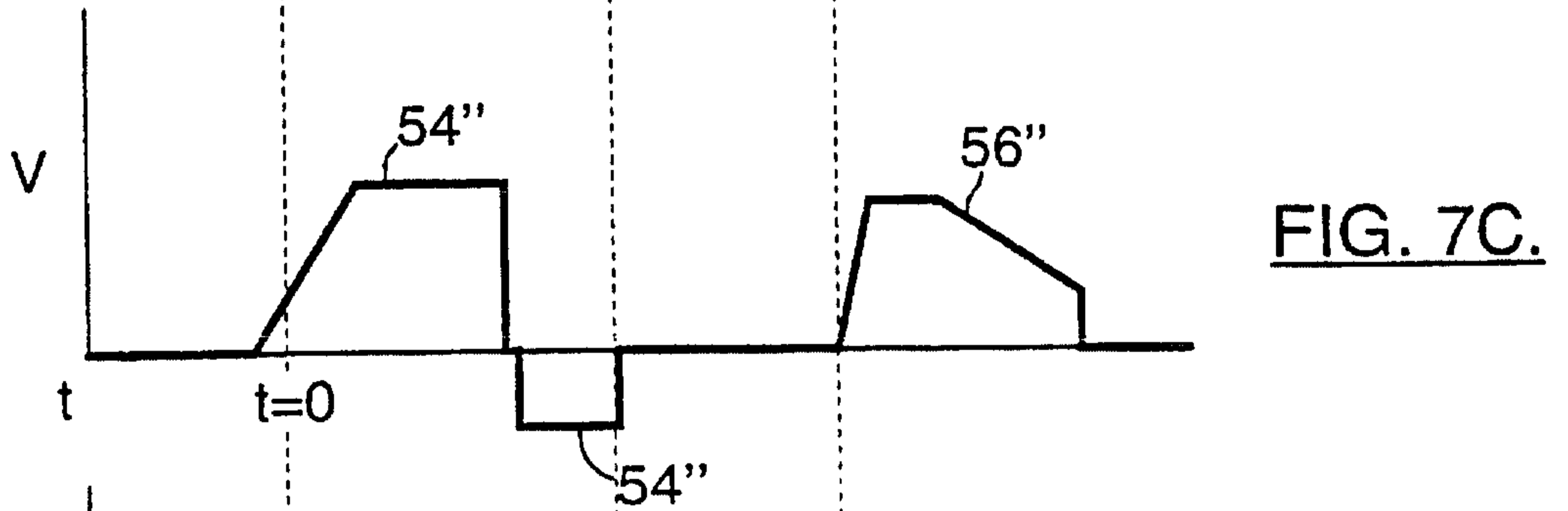
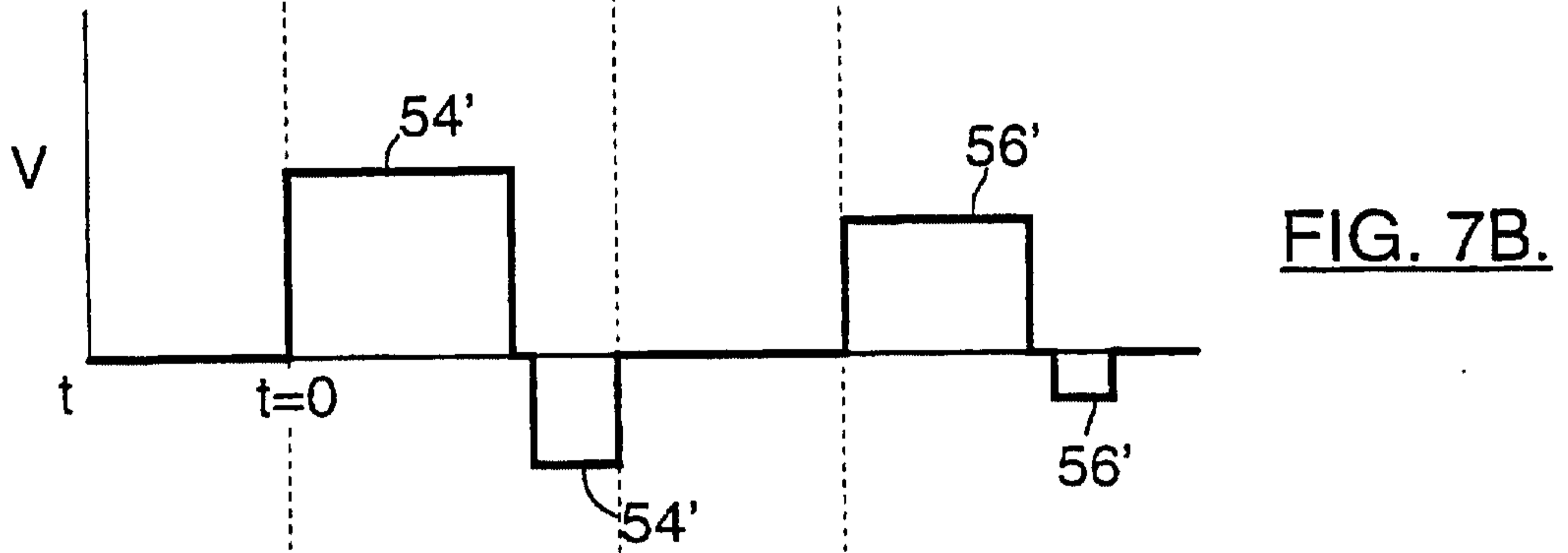
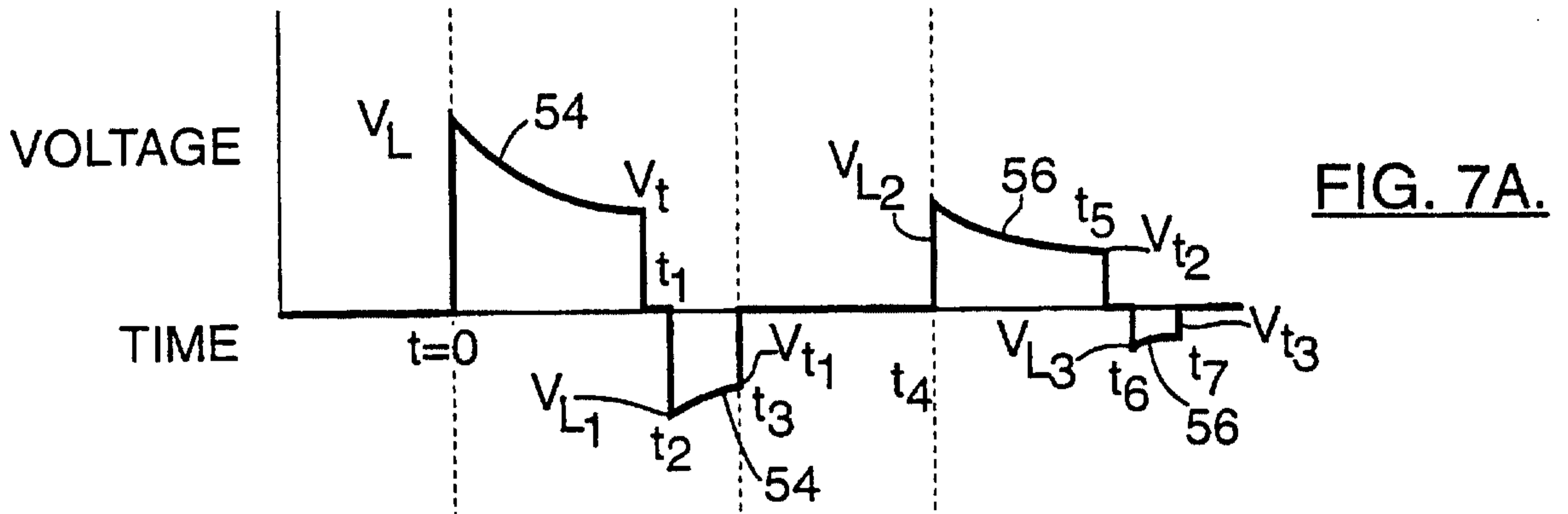

FIG. 6.



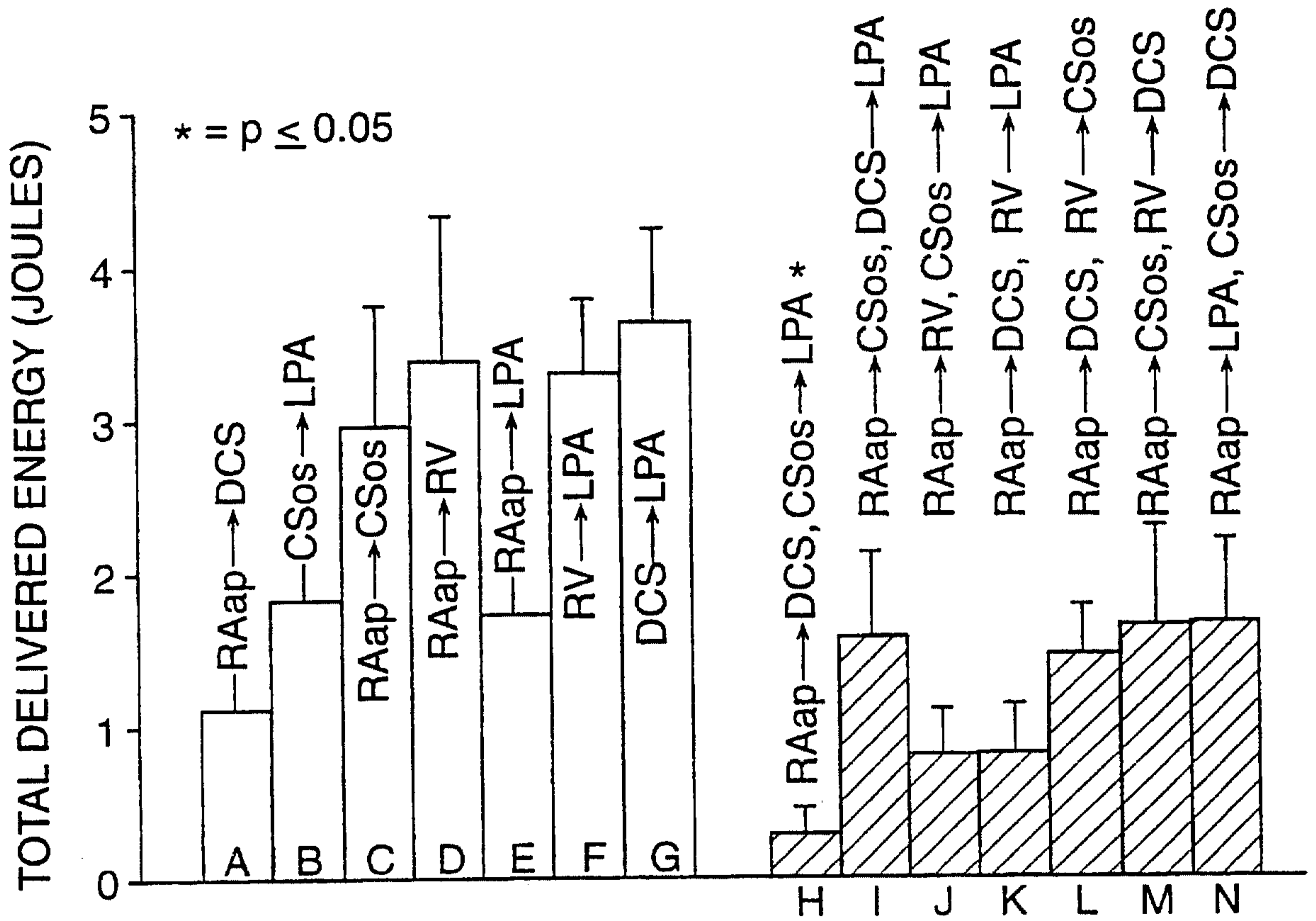

FIG. 8.

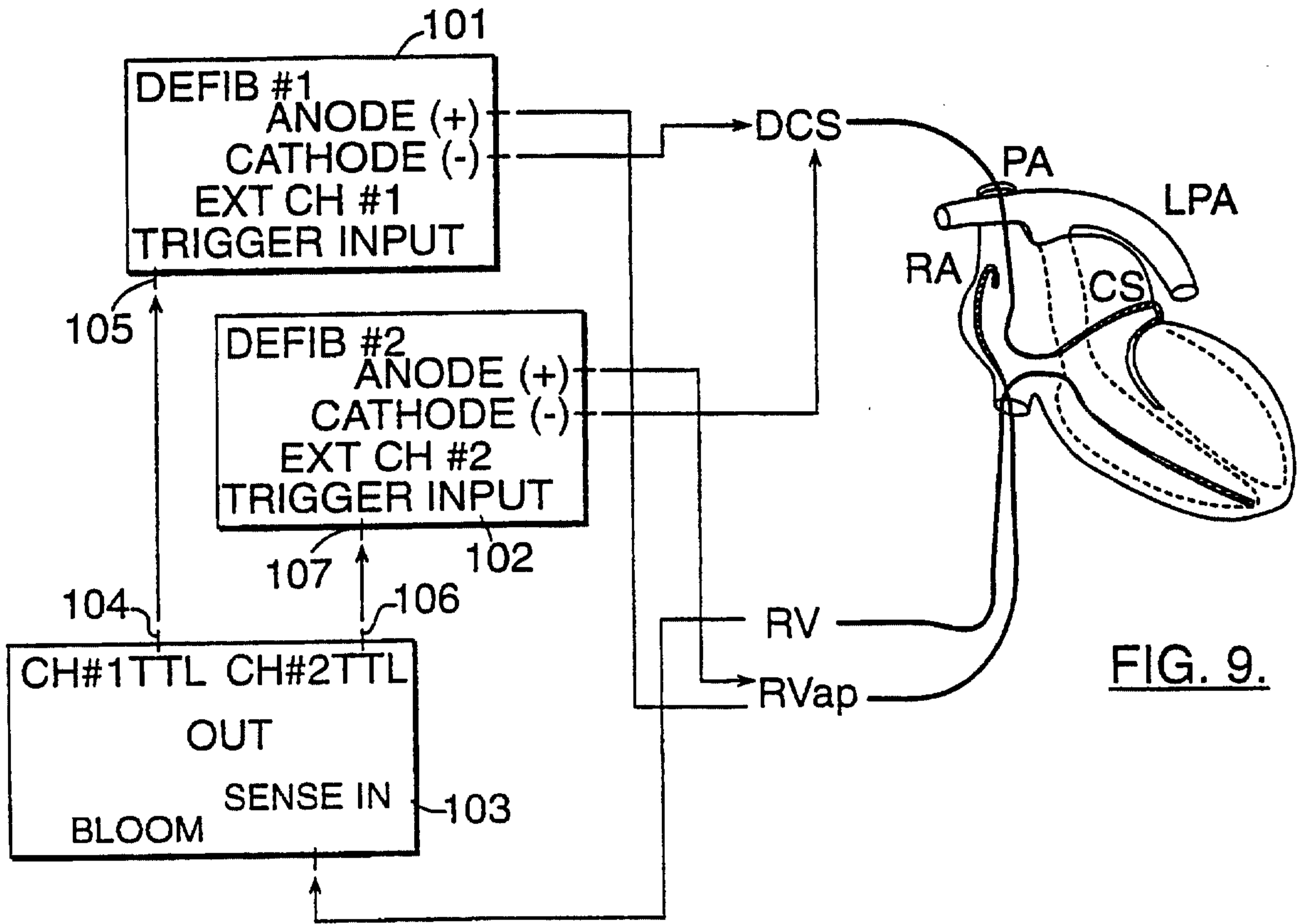

FIG. 9.

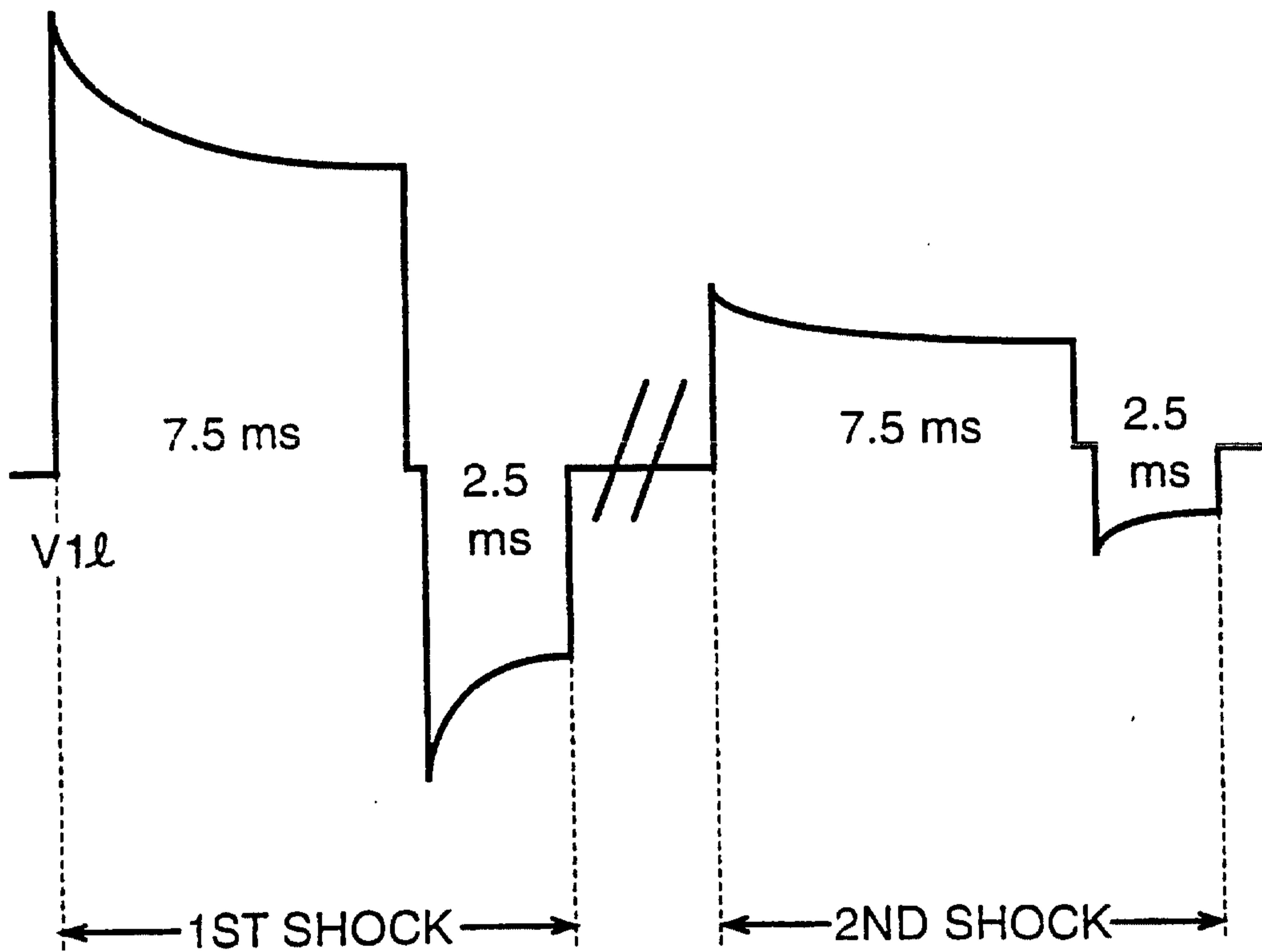

FIG. 10.