



US00D469870S

(12) **United States Design Patent**
Niermann et al.

(10) **Patent No.:** **US D469,870 S**

(45) **Date of Patent:** **** Feb. 4, 2003**

(54) **NEEDLE ASSEMBLY**

(76) Inventors: **Volker Niermann**, 196B Main St.,
Little Falls, NJ (US) 07424; **Bradley
M. Wilkinson**, 39 Hillside Dr., North
Haledon, NJ (US) 07508

(**) Term: **14 Years**

(21) Appl. No.: **29/148,340**

(22) Filed: **Sep. 18, 2001**

(51) **LOC (7) Cl.** **24-02**

(52) **U.S. Cl.** **D24/130; D24/112; D24/113**

(58) **Field of Search** D24/112, 130,
D24/113, 114, 128, 146, 147, 127; 128/DIG. 28;
600/573, 576, 583, 567; 604/177, 164.01,
164.06, 174, 198, 165.04, 165.03, 164.04,
164.08, 164.07

(56) **References Cited**

U.S. PATENT DOCUMENTS

D378,405 S * 3/1997 Musgrave et al. D24/112
5,746,215 A * 5/1998 Manjarrez 600/573

D421,119 S * 2/2000 Musgrave et al. D24/112
6,050,976 A * 4/2000 Thorne et al. 604/164.01
6,273,871 B1 * 8/2001 Davis et al. 604/164.05
D450,834 S * 11/2001 Newby et al. D24/112

* cited by examiner

Primary Examiner—Ian Simmons

(74) *Attorney, Agent, or Firm*—Nanette S. Thomas, Esq.

(57) **CLAIM**

The ornamental design for a needle assembly, as shown and described.

DESCRIPTION

FIG. 1 is a perspective view of a needle assembly showing our new design, the broken line showing is for illustrative purposes only and forms no part of the claimed design; FIG. 2 is a top plan view thereof; FIG. 3 is a left side elevational view thereof; FIG. 4 is a right side elevational view thereof; FIG. 5 is a front elevational view thereof; FIG. 6 is a rear elevational view thereof; and, FIG. 7 is a bottom plan view thereof.

1 Claim, 6 Drawing Sheets

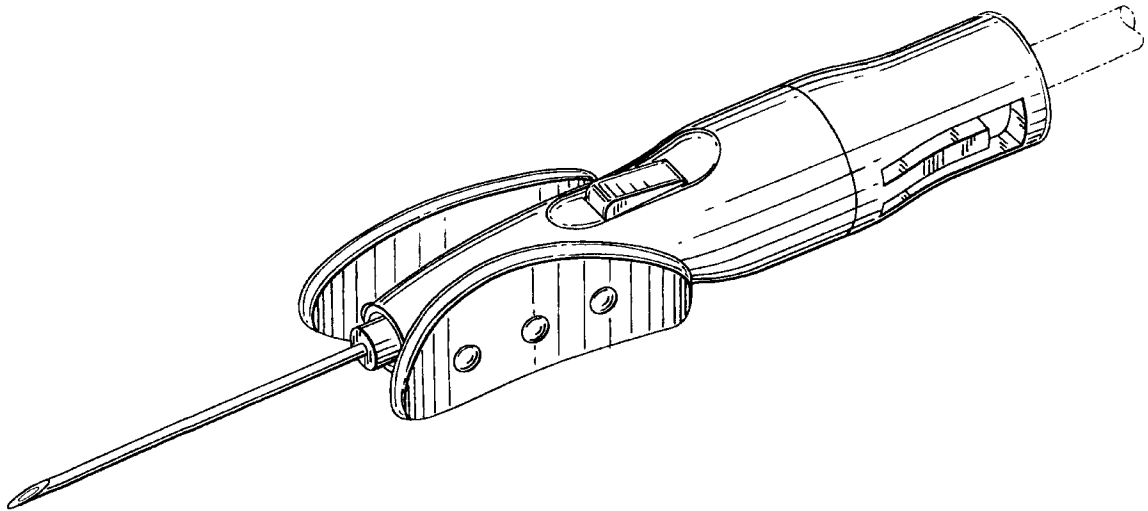

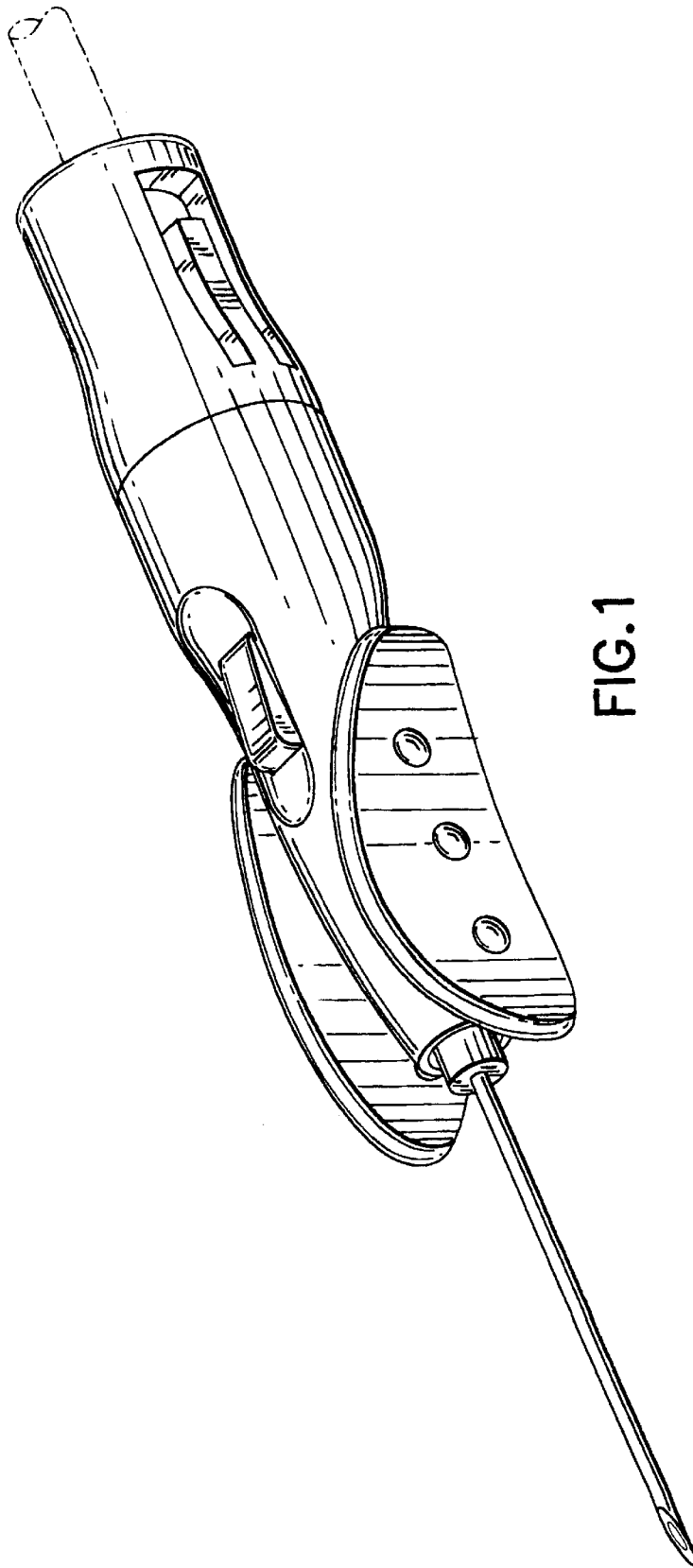

FIG. 1

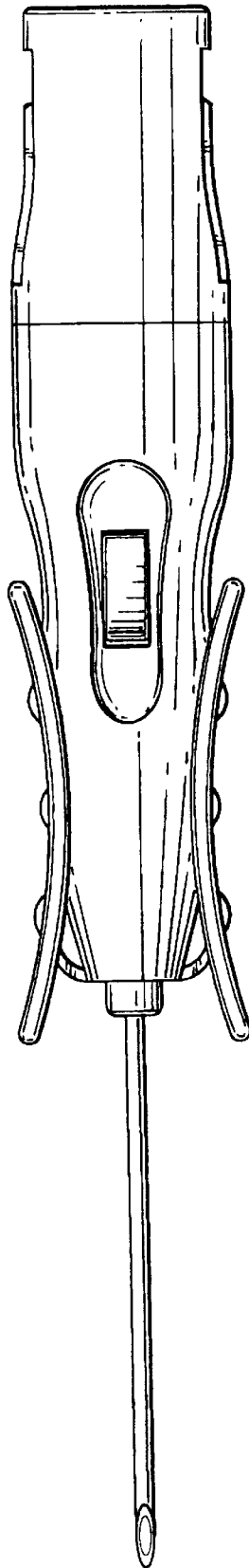

FIG.2

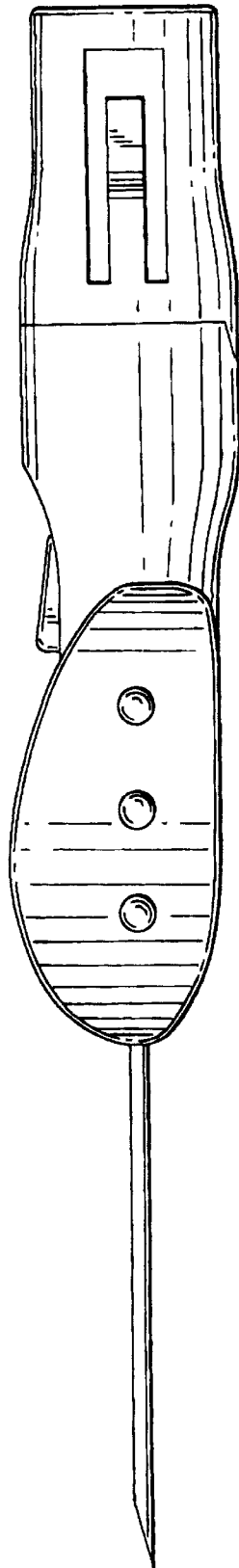

FIG. 3

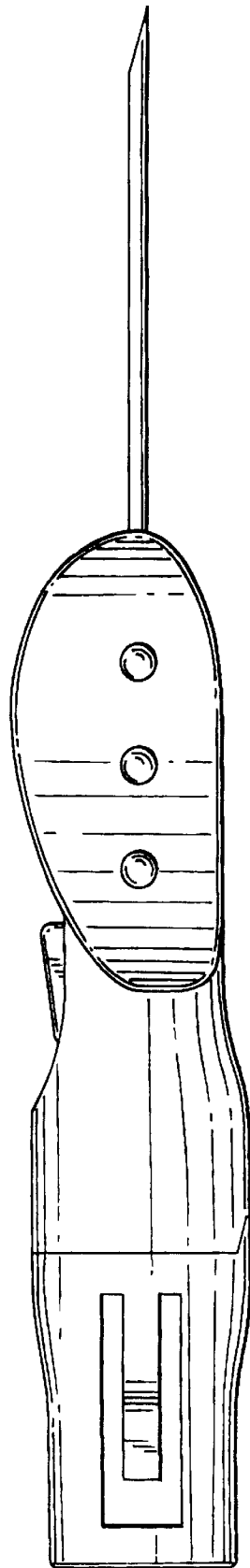

FIG.4

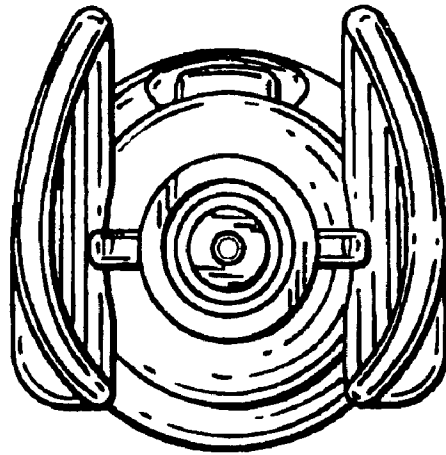

FIG. 5

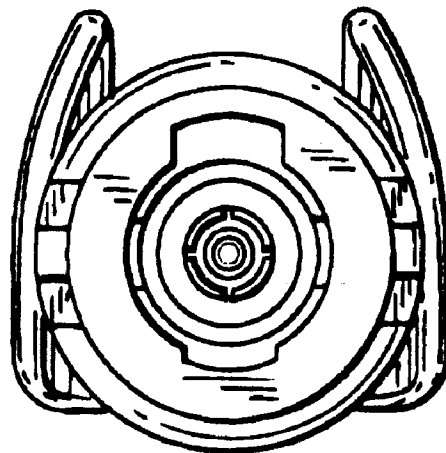

FIG. 6

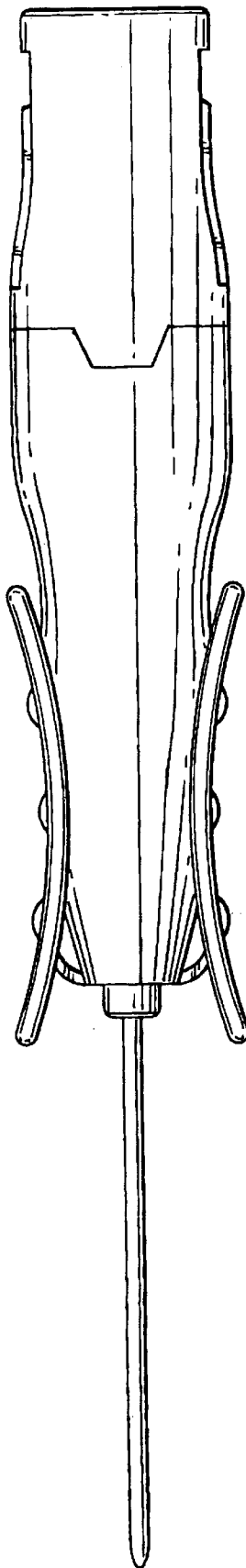

FIG.7