



US00D610296S

(12) **United States Design Patent**
Boissevain et al.

(10) **Patent No.:** **US D610,296 S**

(45) **Date of Patent:** **** Feb. 16, 2010**

(54) **SCONCE LIGHT FIXTURE**

(75) Inventors: **Chris Boissevain**, Wimberley, TX (US);
Donald M. Perreira, San Marcos, TX (US)

(73) Assignee: **Koninklijke Philips Electronics N.V.**,
Eindhoven (NL)

(**) Term: **14 Years**

(21) Appl. No.: **29/330,662**

(22) Filed: **Jan. 12, 2009**

(51) **LOC (9) Cl.** **26-05**

(52) **U.S. Cl.** **D26/85**

(58) **Field of Classification Search** D26/67-72,
D26/85, 92; 362/145, 152, 183, 294, 373,
362/414, 431, 545

See application file for complete search history.

(56) **References Cited**

U.S. PATENT DOCUMENTS

1,215,894 A	2/1917	Yuyama	
D51,774 S	2/1918	Coppinger	
D54,477 S	2/1920	Strahan	
1,356,145 A	10/1920	Hawthorne	
1,486,745 A	3/1924	Haselton	
1,545,711 A	7/1925	Townsend	
1,639,753 A	8/1927	Shelton	
D81,452 S	6/1930	Osborn	
2,075,199 A	3/1937	Horner	
D104,401 S	5/1937	Kanter	
D105,721 S	8/1937	Westfall	
2,132,784 A	10/1938	Guth	
D114,805 S	5/1939	Brooks	
D115,417 S	6/1939	McCann	
D137,508 S	3/1944	Asay	
D151,626 S *	11/1948	Kress D26/85
2,632,095 A	3/1953	Dove	
D172,522 S	6/1954	Stone	
2,732,484 A	1/1956	Lipscomb	
D178,282 S	7/1956	Runtz	
2,767,305 A	10/1956	Onlesen et al.	

2,853,599 A	9/1958	Kliegl
D190,385 S	5/1961	Schreckengost
D191,128 S	8/1961	Curtin et al.
D192,125 S	1/1962	Lasker

(Continued)

OTHER PUBLICATIONS

Visor 20—Outdoor Wall Sconce by LBL Lighting. Found at Lumens.com on Sep. 18, 2009.(3 pages).*

Primary Examiner—Clare E Heflin

(74) *Attorney, Agent, or Firm*—John F. Salazar; Middleton Reutlinger

(57) **CLAIM**

The ornamental design for a sconce light fixture, as shown and described.

DESCRIPTION

FIG. 1 is a top perspective view of the sconce light fixture of the present invention;

FIG. 2 is a front elevation view of the sconce light fixture of FIG. 1;

FIG. 3 is a rear elevation view of the sconce light fixture of FIG. 1;

FIG. 4 is a left side elevation view of the sconce light fixture of FIG. 1, a right side elevation view thereof being a mirror image of the left side elevation view;

FIG. 5 is a top view of the sconce light fixture of FIG. 1; and, FIG. 6 is a bottom view of the sconce light fixture of FIG. 1.

The broken lines showing environmental structure are for illustrative purposes only and form no part of the claimed design.

1 Claim, 6 Drawing Sheets

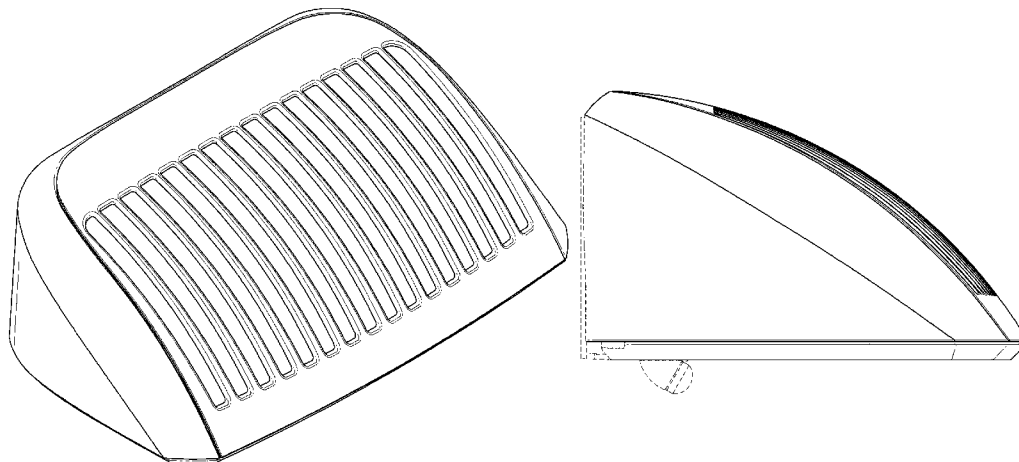

US D610,296 S

U.S. PATENT DOCUMENTS					
D195,584 S	7/1963	D'Ercoli	5,174,648 A	12/1992	Clary et al.
D199,078 S	9/1964	Turner	D336,536 S	6/1993	Shaanan et al.
D199,142 S	9/1964	Daum	D336,964 S	6/1993	Janssen et al.
D199,144 S	9/1964	Daum	D337,835 S	7/1993	Donato et al.
3,156,418 A	11/1964	Jablonski	D338,980 S	8/1993	Dieperink
3,170,634 A	2/1965	Harling	5,232,518 A	8/1993	Nath et al.
D201,909 S	8/1965	Harling	D343,245 S	1/1994	Fouke et al.
D202,212 S	9/1965	Izzi	D343,250 S	1/1994	Fouke et al.
3,340,393 A	9/1967	Franck et al.	D343,251 S	1/1994	Fouke et al.
3,388,246 A	6/1968	Bailey	5,278,737 A	1/1994	Luce et al.
3,448,260 A	6/1969	Wince et al.	D344,606 S	2/1994	Fouke et al.
3,505,515 A	4/1970	Adra	D345,432 S	3/1994	Gruber et al.
D217,638 S	5/1970	Magi	D345,433 S	3/1994	Gruber et al.
D222,103 S	9/1971	Anderson	D345,434 S	3/1994	Gruber et al.
3,604,916 A	9/1971	Adra	D346,874 S	5/1994	Fiorato
3,610,915 A	10/1971	Moore	D346,875 S	5/1994	Rorke
3,666,935 A	5/1972	Pritchett et al.	D347,292 S	5/1994	Roos et al.
3,711,702 A	1/1973	Adra	D347,486 S	5/1994	Gruber et al.
3,732,416 A	5/1973	Audesse et al.	5,309,341 A	5/1994	Russello et al.
3,755,665 A	8/1973	Grindle	D348,531 S	7/1994	Mehaffey et al.
D229,713 S	12/1973	Wince et al.	5,339,234 A	8/1994	Russello et al.
D230,071 S	1/1974	Anderson	D351,919 S	10/1994	Rorke
3,895,227 A	7/1975	Murray et al.	D352,124 S	11/1994	Russello et al.
3,919,542 A	11/1975	Castic	5,377,087 A	12/1994	Yoon
4,090,210 A	5/1978	Webling et al.	D354,580 S	1/1995	Fouke et al.
4,143,413 A	3/1979	Kelly	D355,044 S	1/1995	Russello et al.
4,164,784 A	8/1979	Jaksich	D357,547 S	4/1995	Layh
4,212,050 A	7/1980	Trenkler	D357,761 S	4/1995	DeWinter
4,288,846 A	9/1981	Fletcher et al.	5,404,297 A	4/1995	Birk et al.
D262,914 S	2/1982	Kristofek	D358,898 S	5/1995	Compton
4,319,313 A	3/1982	Eberhart et al.	D358,902 S	5/1995	Webster, III
4,323,953 A	4/1982	Hutchison	5,416,684 A	5/1995	Pearce
4,333,131 A	6/1982	Hujimoto et al.	D364,242 S	11/1995	Fiorato
D267,516 S	1/1983	Rambusch et al.	D367,124 S	2/1996	Sherman
D272,193 S	1/1984	Sangiamo	D370,228 S	5/1996	Chapman et al.
4,434,455 A	2/1984	Merritt	5,584,574 A	12/1996	Haddad
4,447,863 A	5/1984	Fenne	D377,990 S	2/1997	Nakano
4,462,068 A	7/1984	Shadwick	5,613,766 A	3/1997	Raouf
4,473,873 A	9/1984	Quiogue	5,642,934 A	7/1997	Haddad
4,519,018 A	5/1985	Rowland	5,647,659 A	7/1997	Mori
4,527,224 A	7/1985	Sangiamo et al.	D385,643 S	10/1997	Brohard et al.
4,587,602 A	5/1986	Dean et al.	D389,949 S	1/1998	Walker
4,590,544 A	5/1986	Decandia	D390,999 S	2/1998	Gaskins et al.
4,602,320 A	7/1986	Tomkin et al.	D391,659 S	3/1998	Gaskins et al.
D286,206 S	10/1986	Joosten et al.	D392,407 S	3/1998	Johnson et al.
D286,446 S	10/1986	Caroli et al.	D393,733 S	4/1998	Gaskins et al.
4,623,956 A	11/1986	Conti	D394,124 S	* 5/1998	Mackert et al. D26/85
4,636,579 A	1/1987	Hanak et al.	D395,140 S	6/1998	O'Rourke
4,695,930 A	9/1987	Wierzbicki et al.	5,803,585 A	9/1998	Littman et al.
4,709,312 A	11/1987	Heinisch et al.	D399,331 S	10/1998	Greene et al.
D294,066 S	2/1988	Ewing et al.	D399,332 S	10/1998	Greene et al.
4,760,499 A	7/1988	Il	D399,333 S	10/1998	Greene et al.
4,760,511 A	7/1988	Russello et al.	D400,286 S	10/1998	Greene et al.
4,816,969 A	3/1989	Miller	D404,842 S	1/1999	Hurst
D301,175 S	5/1989	Benjamin	D407,842 S	4/1999	Landefield
D302,326 S	7/1989	DiCola	5,906,431 A	5/1999	Chianale et al.
D302,327 S	7/1989	DiCola	D412,037 S	7/1999	Compton
D302,328 S	7/1989	Fretz	5,918,970 A	7/1999	Brohard et al.
D302,329 S	7/1989	Fretz et al.	D415,304 S	10/1999	Brown
D302,330 S	7/1989	Fretz	5,971,571 A	10/1999	Rose
4,858,091 A	8/1989	Fouke	D417,303 S	11/1999	Rahn
D304,092 S	* 10/1989	Glassman D26/85	D418,626 S	1/2000	Herst et al.
D305,694 S	1/1990	Brown	D424,736 S	5/2000	Johnson
D309,956 S	8/1990	Sikora et al.	D425,013 S	5/2000	Lai
D315,612 S	3/1991	Hughes et al.	6,089,732 A	7/2000	Wright et al.
D316,457 S	4/1991	De'Armond	D429,362 S	8/2000	Landefield
D321,408 S	11/1991	Hughes et al.	6,128,868 A	10/2000	Ohtsuka et al.
5,068,769 A	11/1991	Umeda et al.	6,152,583 A	11/2000	Mier-Langner
D323,897 S	2/1992	Compton	D434,873 S	12/2000	Jaspers-Fayers et al.
5,086,379 A	2/1992	Denison et al.	D437,958 S	2/2001	Doron, Jr. et al.
5,158,348 A	10/1992	Sakamoto et al.	D440,692 S	4/2001	Janos et al.
			D442,139 S	5/2001	Sasaoka
			D442,313 S	5/2001	Wojtkowiak et al.

US D610,296 S

D442,319 S	5/2001	Hsu	D482,487 S	11/2003	Russello et al.
D444,258 S	6/2001	Bradford et al.	D484,632 S	12/2003	Lamolinara et al.
6,250,781 B1	6/2001	Straus et al.	D487,600 S	3/2004	Fickas
D444,584 S	7/2001	Landefeld	D488,253 S	4/2004	Chen
D445,943 S	7/2001	Littman	D494,701 S	8/2004	Campbell
D446,340 S	8/2001	Bradford et al.	D495,087 S	8/2004	Brown et al.
D447,590 S	9/2001	Raouf et al.	D497,226 S	10/2004	Nauert
6,290,376 B1	9/2001	Gutierrez et al.	D501,057 S	1/2005	Haugaard et al.
D454,975 S	3/2002	De'Armond et al.	D504,536 S	4/2005	Emory et al.
D456,551 S	4/2002	Russello et al.	D515,231 S	2/2006	Randazzo et al.
D456,552 S	4/2002	Russello et al.	D518,221 S *	3/2006	Randazzo et al. D26/68
D456,553 S	4/2002	Russello et al.	D531,342 S	10/2006	Kauffman et al.
D456,926 S	5/2002	Gaskins et al.	D537,196 S	2/2007	Summerford et al.
D456,927 S	5/2002	Russello et al.	D537,555 S	2/2007	Summerford et al.
D456,928 S	5/2002	Russello et al.	D537,556 S	2/2007	Summerford et al.
D456,929 S	5/2002	Russello et al.	7,244,050 B2	7/2007	Summerford et al.
D456,930 S	5/2002	Russello et al.	D550,388 S *	9/2007	Binsukor D26/67
D459,515 S	6/2002	Gaskins et al.	D555,821 S	11/2007	Russello et al.
D459,519 S	6/2002	Russello et al.	D556,357 S	11/2007	Butler et al.
D460,575 S	7/2002	Tergny et al.	7,296,914 B1	11/2007	Russello et al.
6,422,709 B1	7/2002	Panagiotou	D556,935 S	12/2007	Quioque et al.
D465,048 S	10/2002	Gaskins et al.	D556,938 S	12/2007	Russello et al.
D465,063 S	10/2002	De'Armond	D558,374 S *	12/2007	Sandell D26/71
D465,868 S	11/2002	Gaskins et al.	D562,491 S *	2/2008	DiCola D26/85
6,481,875 B1	11/2002	Bryant	D565,227 S *	3/2008	Haugaard et al. D26/71
D467,030 S	12/2002	Gaskins et al.	D572,403 S	7/2008	Walker
D468,051 S	12/2002	Gaskins et al.	D573,289 S *	7/2008	Xu et al. D26/67
D468,472 S	1/2003	Mullally et al.	D575,900 S	8/2008	Summerford et al.
D469,565 S	1/2003	Anderson et al.	D580,085 S *	11/2008	Svensson D26/71
D472,339 S	3/2003	Russello et al.	D585,580 S	1/2009	Riffel et al.
D476,771 S	7/2003	Herst et al.	D592,346 S *	5/2009	Gill D26/71
D479,624 S	9/2003	Svendson et al.	2006/0090789 A1	5/2006	Thompson
D481,158 S	10/2003	Cline			
D481,159 S	10/2003	Walker			

* cited by examiner

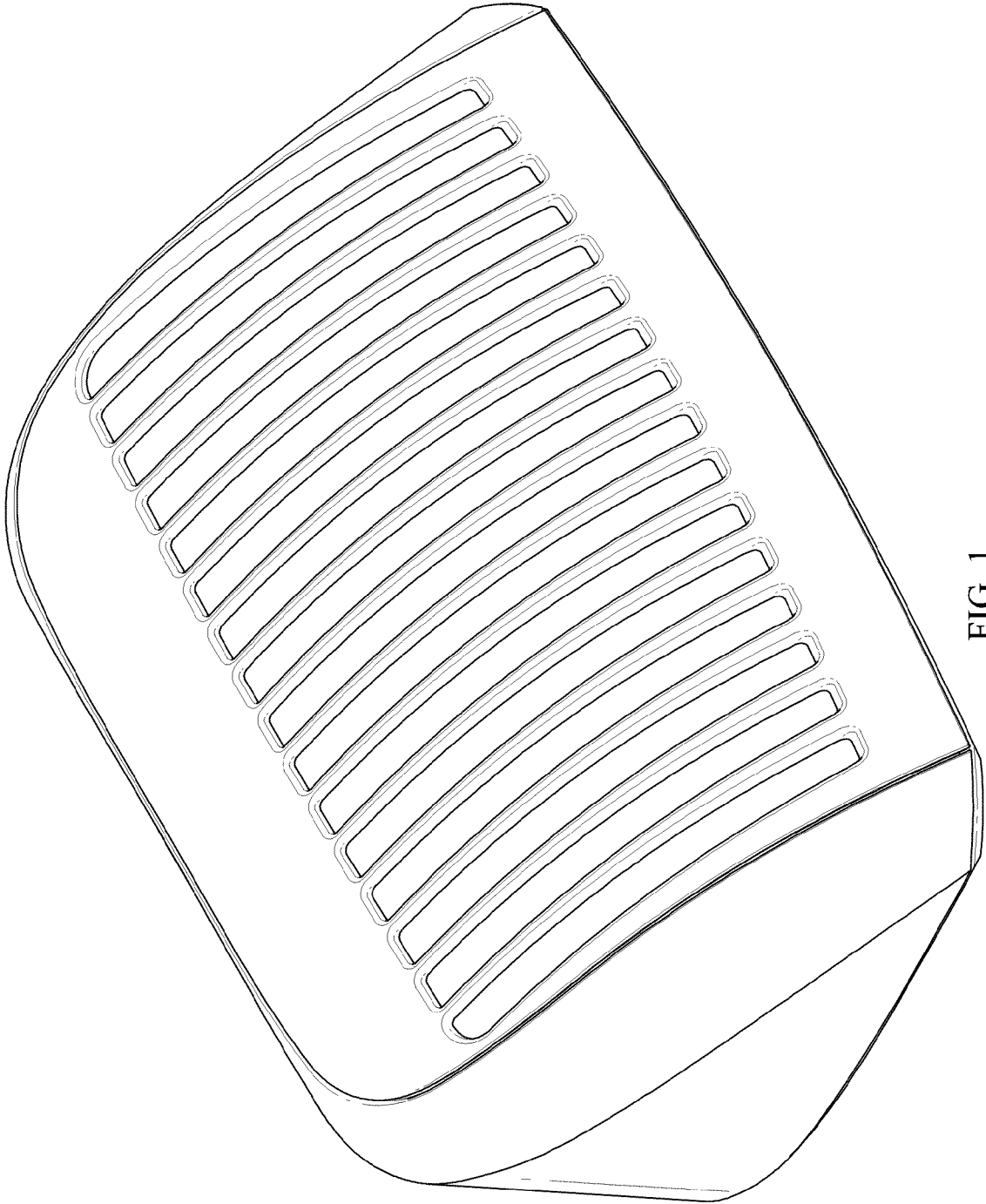

FIG. 1

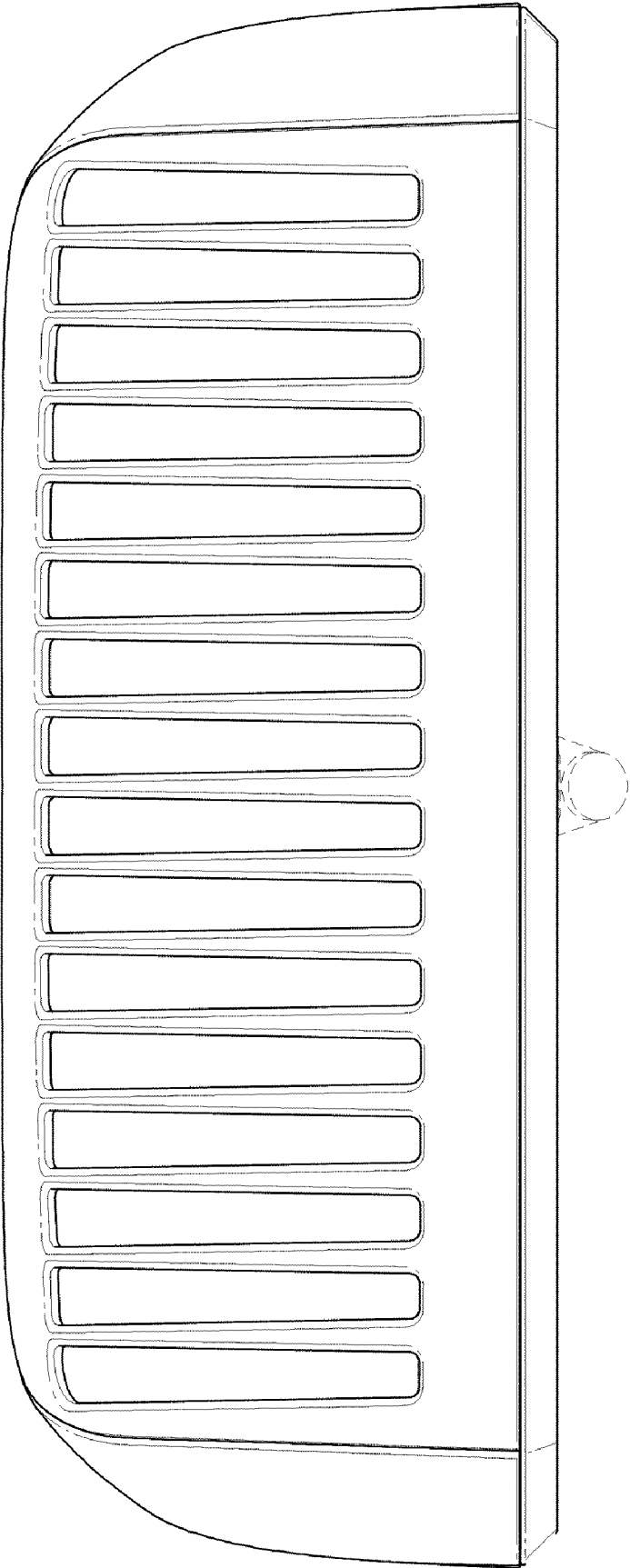

FIG. 2

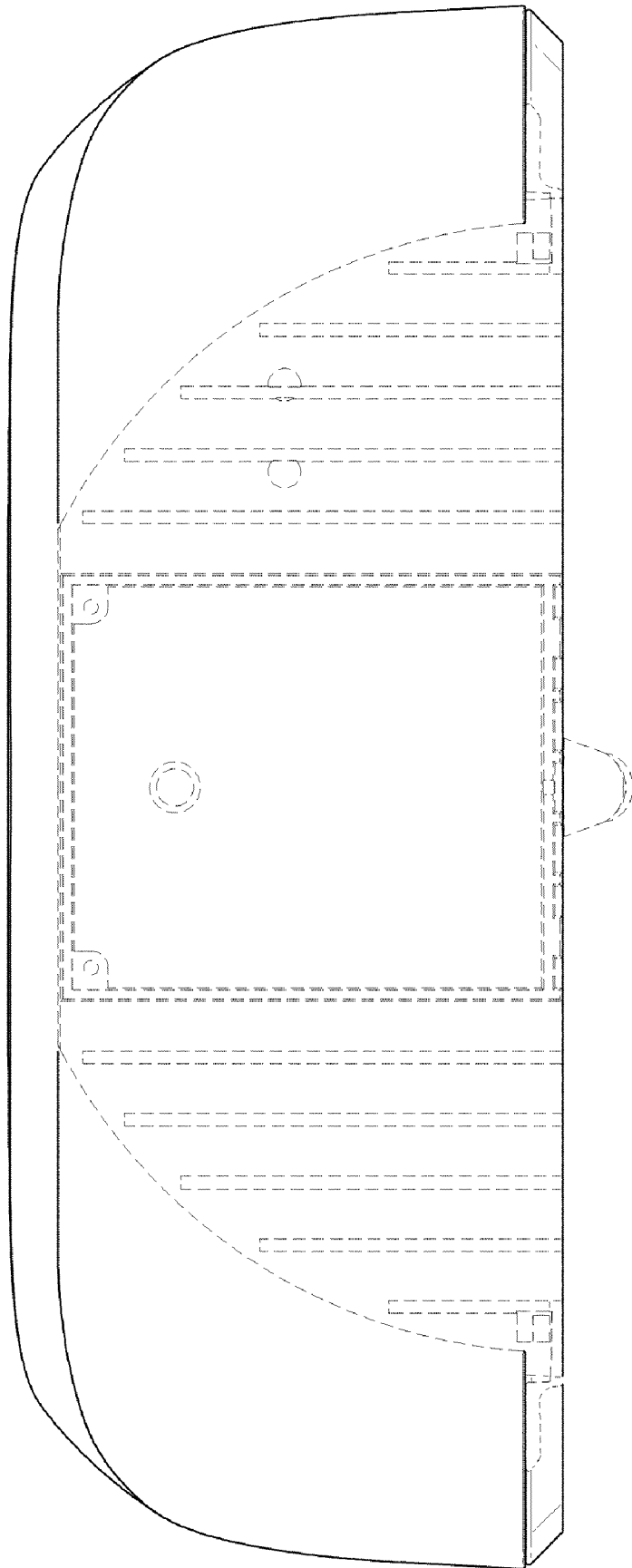

FIG. 3

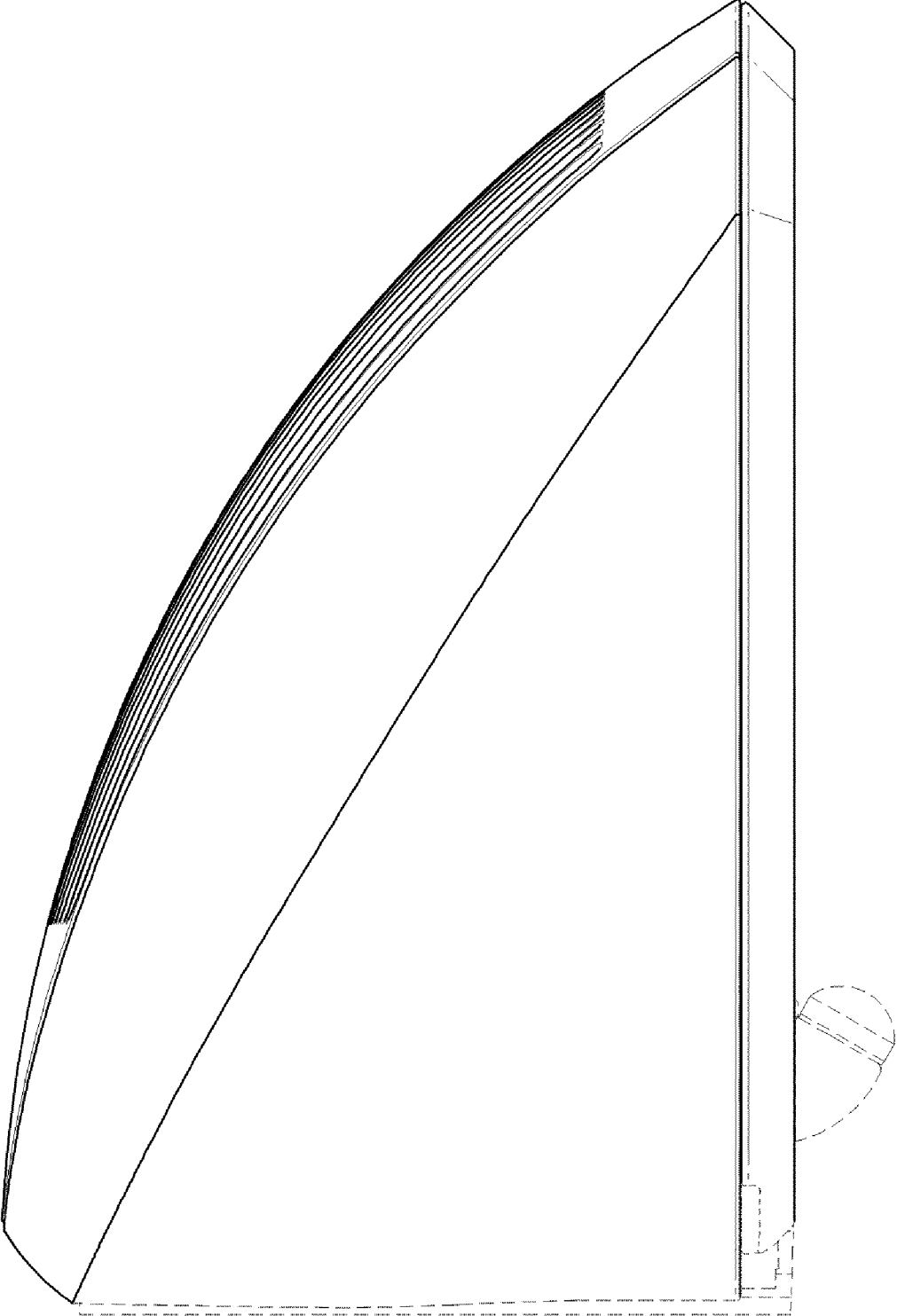

FIG. 4

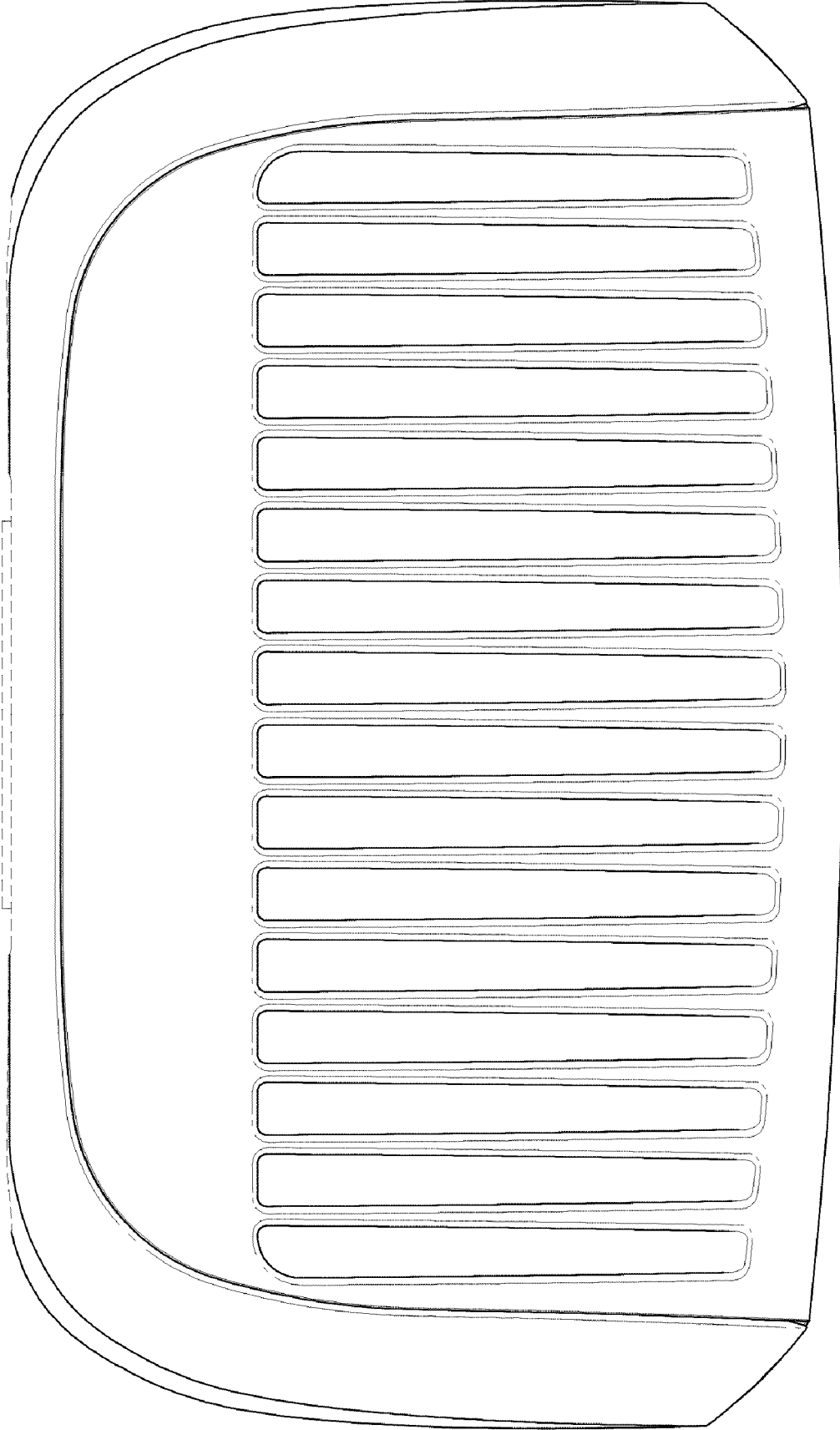

FIG. 5

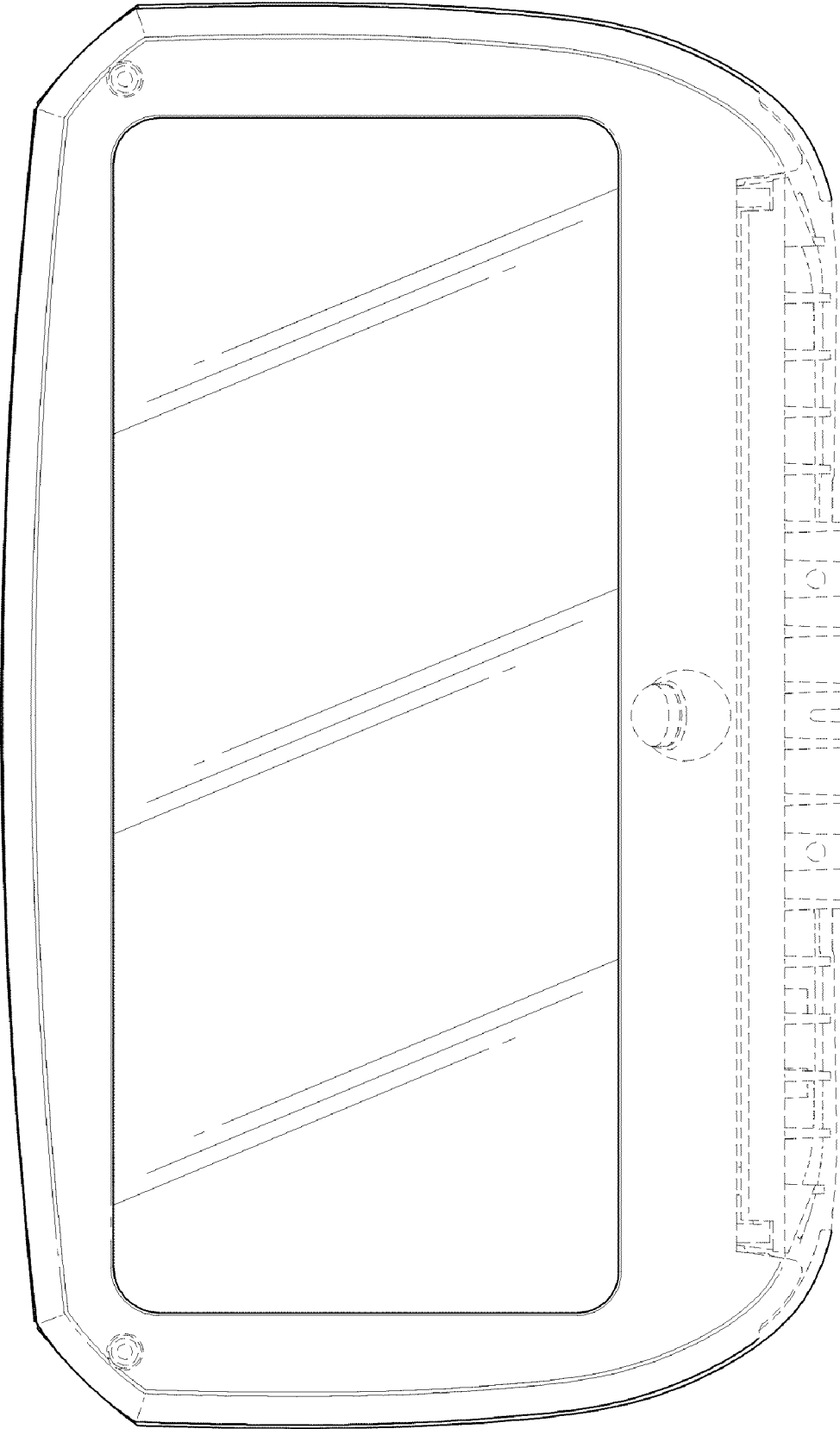

FIG. 6