

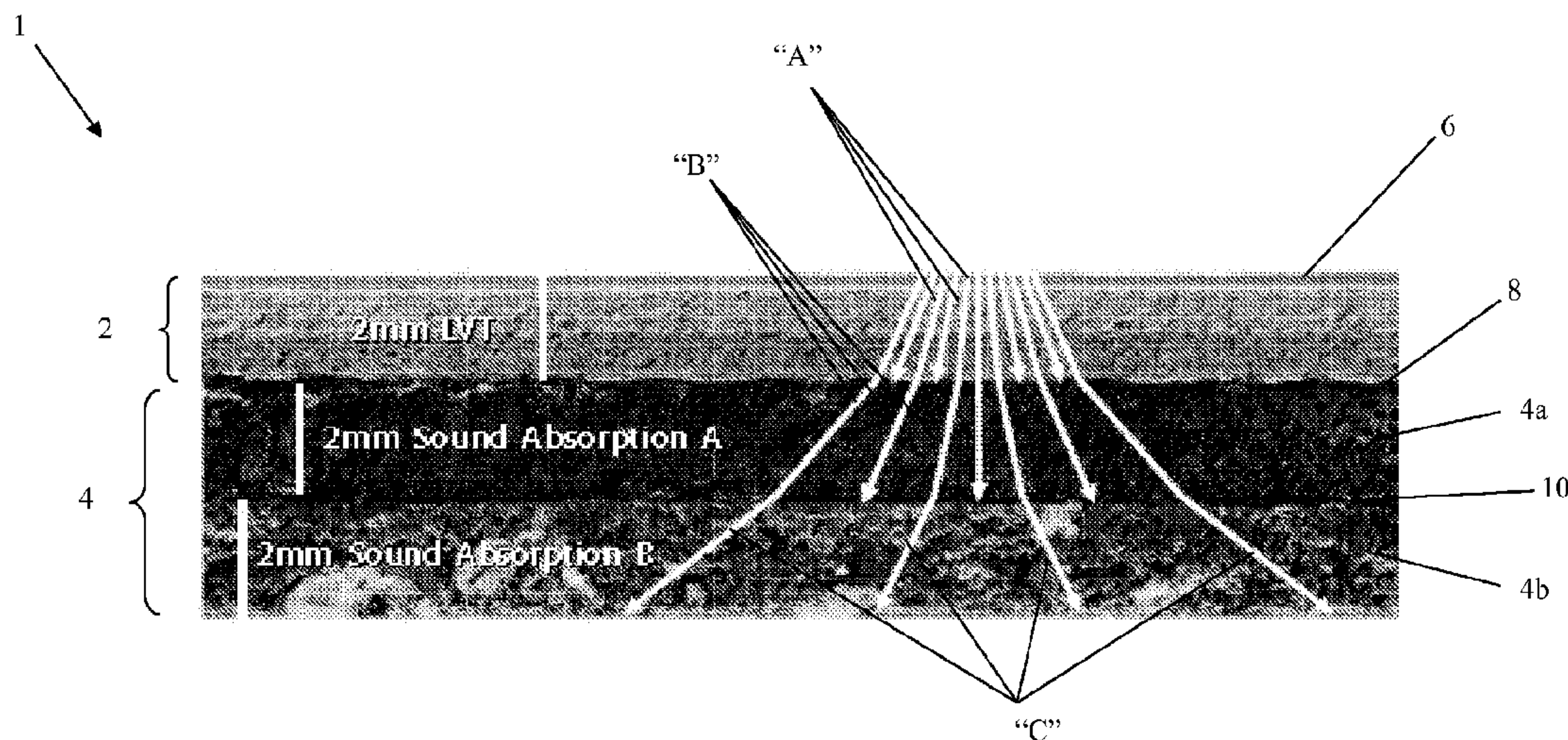

(86) Date de dépôt PCT/PCT Filing Date: 2014/03/21
 (87) Date publication PCT/PCT Publication Date: 2014/10/09
 (45) Date de délivrance/Issue Date: 2017/07/18
 (85) Entrée phase nationale/National Entry: 2015/07/29
 (86) N° demande PCT/PCT Application No.: US 2014/031413
 (87) N° publication PCT/PCT Publication No.: 2014/165335
 (30) Priorité/Priority: 2013/04/05 (US61/808,670)

(51) Cl.Int./Int.Cl. *E04F 15/18* (2006.01),
B32B 25/08 (2006.01), *B32B 33/00* (2006.01),
B32B 37/00 (2006.01), *E04B 1/82* (2006.01),
E04F 13/075 (2006.01), *E04F 13/077* (2006.01)
 (72) Inventeurs/Inventors:
 FREEDMAN, MICHAEL, US;
 TUCKER, DALE, US
 (73) Propriétaire/Owner:
 MICHAEL FREEDMAN & ASSOCIATES, INC., US
 (74) Agent: KIRBY EADES GALE BAKER

(54) Titre : CARREAU DE SOL ACOUSTIQUE MULTICOUCHE ET PROCEDE DE FABRICATION
 (54) Title: MULTI-LAYER ACOUSTICAL FLOORING TILE AND METHOD OF MANUFACTURE



(57) Abrégé/Abstract:

An acoustical vinyl tile having an integral acoustical layer is disclosed. The vinyl tile includes a vinyl portion and an acoustical portion. The acoustical portion comprises a plurality of individual layers, the combination of which is customized to the particular sub-floor structure to which the tile will be adhered or overlain. The individual layers of the acoustical portion can include any of a variety of combinations of rubber, cork, polyurethane foam, and the like. The resulting tile meets one or more of ASTM E 2179, ASTM E 989, ASTM E 492, and ASTM E1007 IIC sound requirements. A method of designing the disclosed tile to suit a particular flooring application is also disclosed. Other embodiments are described and claimed.

(12) INTERNATIONAL APPLICATION PUBLISHED UNDER THE PATENT COOPERATION TREATY (PCT)

(19) World Intellectual Property
Organization
International Bureau(43) International Publication Date
9 October 2014 (09.10.2014)(10) International Publication Number
WO 2014/165335 A1(51) International Patent Classification:
E04B 1/82 (2006.01)(21) International Application Number:
PCT/US2014/031413(22) International Filing Date:
21 March 2014 (21.03.2014)

(25) Filing Language: English

(26) Publication Language: English

(30) Priority Data:
61/808,670 5 April 2013 (05.04.2013) US(71) Applicant: MICHAEL FREEDMAN & ASSOCIATES,
INC. [US/US]; 110 Mayfield Avenue, Edison, New Jersey
08837 (US).(72) Inventors: FREEDMAN, Michael; 110 Briarcliff Drive,
Morganville, New Jersey 07751 (US). TUCKER, Dale;
400 Mountain Creek Trace, Atlanta, Georgia 30328 (US).(74) Agent: CHAMBERLAIN, Jeffrey M.; Kacvinsky Daisak
Bluni PLLC, 3120 Princeton Pike, Suite 303,
Lawrenceville, 08648 (US).(81) Designated States (unless otherwise indicated, for every
kind of national protection available): AE, AG, AL, AM,
AO, AT, AU, AZ, BA, BB, BG, BH, BN, BR, BW, BY,BZ, CA, CH, CL, CN, CO, CR, CU, CZ, DE, DK, DM,
DO, DZ, EC, EE, EG, ES, FI, GB, GD, GE, GH, GM, GT,
HN, HR, HU, ID, IL, IN, IR, IS, JP, KE, KG, KN, KP, KR,
KZ, LA, LC, LK, LR, LS, LT, LU, LY, MA, MD, ME,
MG, MK, MN, MW, MX, MY, MZ, NA, NG, NI, NO, NZ,
OM, PA, PE, PG, PH, PL, PT, QA, RO, RS, RU, RW, SA,
SC, SD, SE, SG, SK, SL, SM, ST, SV, SY, TH, TJ, TM,
TN, TR, TT, TZ, UA, UG, US, UZ, VC, VN, ZA, ZM,
ZW.(84) Designated States (unless otherwise indicated, for every
kind of regional protection available): ARIPO (BW, GH,
GM, KE, LR, LS, MW, MZ, NA, RW, SD, SL, SZ, TZ,
UG, ZM, ZW), Eurasian (AM, AZ, BY, KG, KZ, RU, TJ,
TM), European (AL, AT, BE, BG, CH, CY, CZ, DE, DK,
EE, ES, FI, FR, GB, GR, HR, HU, IE, IS, IT, LT, LU, LV,
MC, MK, MT, NL, NO, PL, PT, RO, RS, SE, SI, SK, SM,
TR), OAPI (BF, BJ, CF, CG, CI, CM, GA, GN, GQ, GW,
KM, ML, MR, NE, SN, TD, TG).

Published:

- with international search report (Art. 21(3))
- before the expiration of the time limit for amending the
claims and to be republished in the event of receipt of
amendments (Rule 48.2(h))

(54) Title: MULTI-LAYER ACOUSTICAL FLOORING TILE AND METHOD OF MANUFACTURE

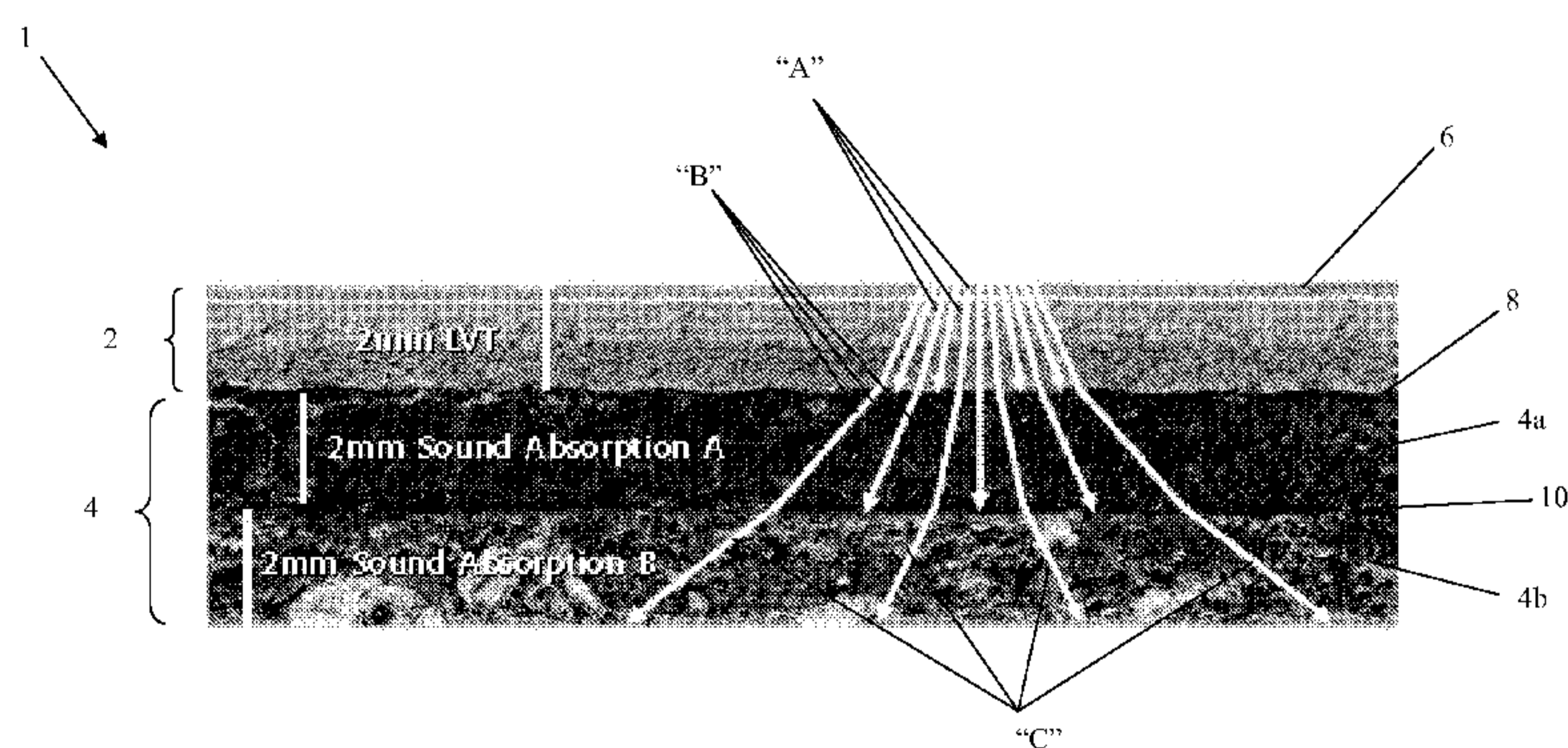

FIG. 2

(57) Abstract: An acoustical vinyl tile having an integral acoustical layer is disclosed. The vinyl tile includes a vinyl portion and an acoustical portion. The acoustical portion comprises a plurality of individual layers, the combination of which is customized to the particular sub-floor structure to which the tile will be adhered or overlain. The individual layers of the acoustical portion can include any of a variety of combinations of rubber, cork, polyurethane foam, and the like. The resulting tile meets one or more of ASTM E 2179, ASTM E 989, ASTM E 492, and ASTM E1007 IIC sound requirements. A method of designing the disclosed tile to suit a particular flooring application is also disclosed. Other embodiments are described and claimed.

WO 2014/165335 A1

MULTI-LAYER ACOUSTICAL FLOORING TILE AND METHOD OF MANUFACTURE**Field of the Disclosure**

[0001] The present disclosure relates to vinyl flooring systems in general, and more particularly, to an improved vinyl tile having enhanced acoustical properties coupled with improved long term stability.

Background of the Disclosure

[0002] Vinyl flooring has been a popular floor covering material for many years. Vinyl flooring is typically available in either tile or sheet form for both commercial and residential use. As finished flooring material, vinyl tile has been used extensively in commercial, institutional and public building applications, such as, for example, malls, schools, healthcare facilities, convention and exposition centers, civic buildings, private office buildings, sports facilities, and so forth. Vinyl flooring is durable, easy to maintain and is often more moisture-resistant than many alternative flooring materials. Vinyl flooring can also have limited acoustical properties, in that the material offers some rebound or resilience upon compression (i.e., when walked on).

[0003] Vinyl tiles can be composed of colored vinyl formed into generally planar solid sheets by heat and pressure, and cut into squares or other shapes. Manufacturers have created vinyl tiles that very closely resemble wood, stone, terrazzo, and concrete. Tiles are typically applied to a smooth, leveled bare floor or sub-floor usually using a suitable adhesive.

[0004] Conventional vinyl tiles are often installed over an acoustical base layer such as rubber or cork. The acoustical layer can serve one or more of a variety of different functions in a given installation. In some installations, the function of this underlayment material is to

provide a cushioning effect to the floor system. In other situations, the function of the underlayment material is to compensate for imperfections in the surface of the subfloor, which can be concrete, plywood, or a number of other different materials that are commonly used and known. Another function of the underlayment, which is particularly pertinent to the present invention, is to reduce the transmission of sound through the floor to a room below, such as in the case of a multi-floor building. This is particularly significant where the maximum allowable level of sound transmission is controlled by local building codes, which is increasingly common.

[0005] In such cases, a single acoustical base layer is adhered to the sub-floor, and the vinyl tiles are installed over the acoustical base layer, again using an adhesive. The base layer and vinyl tiles are standard elements that are used without regard for the particular sub-floor structure upon which the sub-floor is laid.

[0006] Different building structures can transmit sound differently, depending upon the materials of construction as well as the construction arrangement (e.g., wooden floor/ceiling beams, poured concrete, and the like). Because current vinyl tile systems employ a standard base layer, they are incapable of dampening sound optimally across a variety of floor/ceiling structure types. For example, while a typical tile may provide reasonable acoustical dampening when applied over a poured concrete floor, it may not provide acceptable dampening when applied over a wood beam-supported floor.

Summary of the Disclosure

[0007] In view of the aforementioned deficiencies in the prior art, an improved vinyl tile system is disclosed whose structure can be customized to provide a desired acoustical dampening for any of a variety of different flooring structures. The improved vinyl tile

system includes sound dampening properties that meet applicable acoustical limitations associated with multi-family dwellings. The improved vinyl tile also provides a desired resilience, and is easy to manufacture and install. These and a number of additional objectives are met by the disclosed vinyl tile.

[0008] The disclosed system and method include an improved vinyl tile having enhanced stability, resilience and acoustical properties. The disclosed vinyl tile incorporates an acoustical layer made up of a plurality of individual sublayers. The composition and arrangement of the sublayers can be adjusted to provide desired sound dampening properties that are customized to a particular flooring structure.

[0008a] Certain exemplary embodiments can provide a vinyl tile, comprising: a vinyl portion; and an acoustical portion disposed adjacent the vinyl portion, the acoustical portion comprising a plurality of individual acoustical sub-layers each providing acoustical dampening at a different frequency; wherein first and second sub-layers of the plurality of individual acoustical sub-layers comprise material compositions that are different from each other; and wherein the plurality of individual sub-layers comprise materials selected from the list consisting of rubber, a mixture of cork and rubber, a mixture of rubber and polyurethane foam (PU), a mixture of PU foam and cork, and combinations thereof.

[0008b] Certain exemplary embodiments can provide a method of designing a vinyl tile to suit a particular flooring application, comprising: determining a type of a sub-floor system that includes a floor/ceiling assembly to which a vinyl tile will be applied; selecting an acoustical portion of said vinyl tile to include "n" sub-layers, where "n" is a number greater than 1 and is based on the type of said sub-floor; and selecting a material composition for each of said "n"

3a

sub-layers, where the material composition for each of said "n" sub-layers is based on the type of said sub-floor system that includes the floor/ceiling assembly and the number "n" of sub-layers.

[0008c] Certain exemplary embodiments can provide a vinyl tile, comprising: a vinyl portion; and an acoustical portion comprising a plurality of individual acoustical sub-layers each providing acoustical dampening at a different frequency; wherein first and second sub-layers of the plurality of individual acoustical sub-layers comprise material compositions that are different from each other; and wherein the plurality of individual sub-layers comprise materials selected from the list consisting of rubber, a mixture of cork and rubber, a mixture of rubber and polyurethane foam (PU), a mixture of PU foam and cork, and combinations thereof.

[0008d] Certain exemplary embodiments can provide a vinyl tile, comprising: a vinyl portion; and an acoustical portion disposed adjacent the vinyl portion, the acoustical portion comprising a plurality of individual sub-layers; wherein the plurality of individual sub-layers comprise first, second and third individual sub-layers; and wherein the first, second and third individual sub-layers each comprises a material composition that is different from the other individual sub-layers; and wherein the first, second and third individual sub-layers comprise materials selected from the list consisting of rubber, a mixture of cork and rubber, a mixture of rubber and polyurethane foam (PU), a mixture of PU foam and cork, and combinations thereof.

[0009] In some embodiments, a sound dampening material is bonded to a vinyl tile slab prior to cutting the product into tiles or planks. The formulation of the acoustical sound dampening material may be selected to be compatible with the adhesive used to fix the material to the vinyl tile slab. Such a formulation may ensure a good long term bond between the sound

3b

dampening material and the vinyl tile slab. The acoustical sound dampening material may also be selected to be compatible with the vinyl tile slab material, which may reduce or eliminate discoloration of the vinyl tile over the lifetime of the flooring system. Embodiments of the disclosed tile incorporate the aforementioned chemical compatibility while still providing desired acoustical properties. The disclosed vinyl tiles may find application in multi-family housing developments, which as previously noted, can benefit greatly from the associated sound dampening properties.

[0010] A vinyl tile is disclosed. The vinyl tile may include a vinyl portion and an acoustical portion comprising a plurality of individual sub-layers. First and second sublayers of the plurality individual sub-layers may comprise material compositions that are

different from each other. The first and second sub-layers have thicknesses that are different from each other. The first and second sub-layers may have thicknesses that are the same. The first sub-layer may comprise rubber and the second sub-layer may comprise rubber and cork. The first sub-layer may comprise rubber and cork and the second sub-layer may comprise rubber. In some embodiments, the plurality of individual sub-layers includes three individual sub-layers. The at least three individual sub-layers may each comprise a material composition that is different from the other individual sub-layers. In other embodiments, the plurality of individual sub-layers comprise greater than three individual sub-layers.

[0011] A method is disclosed for designing a vinyl tile to suit a particular flooring application. The method may include: determining a type of a sub-floor system that includes the floor/ceiling assembly to which a vinyl tile will be applied; selecting an acoustical portion of said vinyl tile to include "n" sub-layers, where "n" is a number greater than 1 and is based on the type of said sub-floor; and selecting a material composition for each of said "n" sub-layers, where the material composition for each of said "n" sub-layers is based on the type of said sub-floor and the number "n" of sub-layers. The method may also include selecting a thickness of each of the "n" sub-layers based on the type of said sub-floor system that includes the floor/ceiling assembly, the number "n" of sub-layers and the material of each of the sub-layers. The method may further include bonding the "n" individual sub-layers together to form said acoustical portion. The method may also include bonding the acoustical portion to a vinyl tile portion of said vinyl tile. The method may also include applying the vinyl tile to the sub-floor.

Brief Description of the Drawings

[0012] By way of example, a specific embodiment of the disclosed vinyl tile will now be described, with reference to the accompanying drawings, in which:

[0013] FIG. 1 is an isometric view of an embodiment of an exemplary vinyl tile according to the disclosure;

[0014] FIG. 2 is a cross-section view of the vinyl tile of FIG. 1;

[0015] FIG. 3 shows the vinyl tile of FIG. 2 applied over a truss-based sub-floor;

[0016] FIG. 4 is a cross-section view of an alternative exemplary vinyl tile according to the disclosure;

[0017] FIG. 5 shows the vinyl tile of FIG. 4 applied over a concrete sub-floor; and

[0018] FIG. 6 is a logic diagram illustrating a method according to the disclosure.

Detailed Description

[0019] The disclosed vinyl tile comprises a vinyl layer with an integrated sound reducing underlayment permanently attached thereto. The resulting floor/ceiling assembly including the tile meets one or more of ASTM E 2179, ASTM E 989, ASTM E 492, and ASTM E1007 IIC sound requirements. The disclosed vinyl tile includes a customizable sound reducing underlayment (referred to as an "acoustical layer" or "acoustical portion") that is selected for the particular sub-floor system that includes the floor/ceiling assembly design with which the tile will be used. The disclosed tile thus provides a desired level of sound dampening that is not achievable with prior standard tiles. The acoustical layer includes a plurality of sub-layers that can be formulated from different materials, and provided in different thicknesses, to provide superior sound dampening characteristics based on the associated sub-floor system that includes the floor/ceiling assembly design. In some embodiments, the disclosed vinyl

tile includes recycled content. In other embodiments, the disclosed vinyl tile includes an antifungal compound to inhibit the growth of fungus.

[0020] Referring to **FIG. 1**, an exemplary vinyl tile 1 includes an upper vinyl portion 2 and a lower acoustical portion 4. Although the vinyl tile 1 is shown as having a rectangular plank shape, it will be appreciated that tiles according to the disclosure can be manufactured in any of a variety of desired geometric and non-geometric shapes. Non-limiting examples of such shapes include rectangular planks with a width of 4-inches and a length of 36-inches, rectangular planks with a width of 6-inches and a length of 36-inches, and 18-inch by 18-inch square shapes.

[0021] The vinyl portion 2 may include a surface wear layer 6 to enhance the wear life of the vinyl portion. The surface wear layer 6 may have a thickness of about 0.005-inches (5 mils) to about 40 mils. In one embodiment, the surface wear layer may be about 8 mils. The surface wear layer 6 may comprise polyvinyl chloride (PVC). In one non-limiting exemplary embodiment, the surface wear layer 6 includes at least 90% PVC. The vinyl portion 2 may comprise a polyvinylchloride (PVC) material. The acoustical portion 4 may comprise a plurality of layers including a variety of different sound dampening materials, as will be described in greater detail later. The vinyl portion 2 may be bonded to the acoustical portion 4 using a suitable adhesive 8.

[0022] **FIG. 2** shows a cross-section of the vinyl tile 1. This exemplary embodiment includes a vinyl portion 2 (with surface wear layer 6) and an acoustical portion 4 that includes first and second sub-layers 4a, 4b. The vinyl portion 2 can be bonded to the first sub-layer 4a by adhesive layer 8, while the first and second sub-layers 4a, 4b can be bonded together by

adhesive layer 10. It will be appreciated that in some embodiments the layers may be bonded to each other without adhesive, such as by heat bonding or the like.

[0023] The acoustical portion 4 (including its sub-layers) can be permanently bonded to the vinyl portion 2 using an adhesive layer 8 material that is highly compatible both with the vinyl portion 2 and the first sub-layer 4a. Likewise, the material making up the first sub-layer 4a may be highly compatible with the vinyl portion 2 to reduce the chances for de-lamination and/or degradation of the vinyl portion from the acoustical portion during extended use. The same may be true of the compatibility of the adhesive layer 10 and the first and second sub-layers 4a, b to ensure long term durability of the resulting tile 1.

[0024] In the illustrated embodiment, the vinyl portion 2 has a thickness of about 2 millimeters (mm), while the acoustical portion 4 has a combined thickness of about 4 mm. The sub-layers 4a, 4b are shown as having thicknesses of 2 mm each. It will be understood that these thicknesses are merely exemplary, and that different individual layer thicknesses can be used to suit a particular application, as will be explained.

[0025] As previously noted, it is desirable that the actual composition of layers within the tile 1 be variable so as to be customizable to the particular flooring application. That is to say that different sub-floor structures can require different combinations of acoustical portion sub-layer gauges, thicknesses and materials in order to achieve specific construction demands of a particular building. It will be appreciated that modern construction methods include the manufacture of buildings having concrete sub-flooring (six-inch concrete, light concrete, etc.), and a wide variety of different truss-based sub-floor systems (metal trusses, wooden trusses, and combinations thereof). In addition, a single building may include multiple different sub-floor types, each of which can have a different acoustical "response." As will

be appreciated, in vinyl tiles 1 used with each of these different sub-flooring types may need to include a customized acoustical portion 4 in order to provide desired sound dampening in such buildings.

[0026] Thus, to accommodate these applications, the acoustical portion 4 may include a plurality of sub-layers 4a – 4n of sound dampening material. Although the illustrated embodiments include two sub-layers (4a, 4b) it will be appreciated that more than two sub-layers (i.e., up to "n" sub-layers) as desired to suit the application. In addition, although the illustrated embodiments show individual sub-layers 4a, 4b having respective thicknesses of 2 mm, that other thicknesses may also be used. The individual materials used to form the sub-layers 4a-4n may be formulated to minimize sound impact transmissions at specific frequencies. Likewise, the thicknesses of the sub-layers 4a-4n may be selected to work in combination with the individual sub-layer material types to minimize sound impact transmissions at specific frequencies. By structuring the acoustical layers according to the particular type of sub-floor assembly, sound reduction can be fine-tuned for a particular structure.

[0027] As can be seen in **FIG. 2**, sound (represented by arrows "A") is transmitted through the vinyl portion 2. The sound (represented by arrows "B") is then transmitted through the first sub-layer 4a. The sound (represented by arrows "C") is finally transmitted through the second sub-layer 4b at a third frequency and magnitude. The resulting tile 1 meets ASTM E 2179 IIC sound requirements. As the sound moves through each layer 2, 4a, 4b, sound at various frequencies is reduced and absorbed.

[0028] A non-limiting exemplary listing of of appropriate sub-layer materials include the following:

[0029] 1) Rubber layers;

[0030] 2) Rubber and cork formulated together;

[0031] 3) Rubber and polyurethane (PU) foam formulated together;

[0032] 4) PU Foam and cork formulated together; and the like.

[0033] The above, and other, materials can be provided in a variety of different densities, multiple thicknesses, and may include one or more fiber components.

[0034] Each of the sub-layers 4a-4n may have a thickness in the range of about 0.5mm to about 5.5 mm. The thickness of the assembled layers (i.e., total thickness of the acoustical portion 4) may be between about 2.5 mm to about 6 mm. As previously noted, the number of sub-layers can be as few as two, but is not limited to several as the requirements are met for a particular need. The layers are bonded together with specific adhesives in various ways depending on the composition of the layers. A non-limiting exemplary listing of such adhesives includes cyanoacrylate, latex, acrylic, epoxy and the like.

[0035] In some embodiments, incorporating polyurethane into one or more of the sub-layers 4a-4n can enhance compatibility between the acoustical portion 4 and the vinyl portion 2. In one non-limiting exemplary embodiment, the acoustical portion comprises about 10-40% crumb rubber, about 60-90% polyurethane foam, and a resin binder. In some embodiments the crumb rubber component is obtained from recycled tires or sneaker rubber. The polyurethane foam may be an appropriate open cell or closed cell foam, while the resin binder may be a polyurethane binder.

[0036] As noted, different sub-floor systems that includes the floor/ceiling assembly structures transmit sound differently, and thus it can be desirable to customize the individual sub-layers 4a-4n of a vinyl tile 1 to suit the application. **FIG. 3** shows the vinyl tile 1 of **FIG. 2** applied over a wood truss sub-floor assembly 12. As can be seen, a wood truss sub-floor assembly 12 might be made of a variety of different burling materials, including plywood sheathing 14, wood beams 16, metal fastening plates 18, gypsum board 20 (where the sub-floor forms part of an adjoining ceiling, as in the illustrated embodiment), resilient channels 22, etc. As will be appreciated, wood trusses tend to deflect and require backings that take such flexure into account. Thus, in the **FIG. 3** embodiment, the acoustical portion 4 includes a first sub-layer 4a comprising a rubber material, and a second sub-layer 4b comprising a combination of rubber and cork. Each of the sub-layers 4a, 4b of this embodiment are about 2 mm thick, and are adhered together using any of a variety of appropriate adhesives, as previously described.

[0037] **FIG. 4** shows an exemplary alternative floor tile 24 that includes a vinyl portion 26, and an acoustical portion 28 adhered thereto using an adhesive layer 30. In this embodiment, the acoustical portion 4 again includes first and second sub-layers 4a, 4b. By contrast to the prior embodiment, however, the first sub-layer 4a comprises a cork and rubber combination, while the second sub-layer 4b comprises a rubber layer. As shown in **FIG. 5**, this alternative tile may be appropriate for use with a concrete sub-floor 32. Since concrete is more homogenous and rigid than the previously described wooden truss floor assembly 12, it can transmit more sound at some frequencies than others.

[0038] Referring now to **FIG. 6**, a method for designing, manufacturing, and applying a vinyl tile 1 to suit a particular flooring application will now be described. At step 100, the design of a particular sub-floor system that includes the floor/ceiling assembly to which the

vinyl tile 1 will be applied is determined. At step 110, an acoustical portion is designed to include "n" individual sub-layers where "n" is a number greater than 1. The number "n" of individual sub-layers is selected based on the design of the sub-floor. At step 120 each the "n" sub-layers are selected to comprise a particular material. The particular material selected for each individual sub-layer is based on the design of the sub-floor system that includes the floor/ceiling assembly and the number "n" of sub-layers. At step 130, each of the "n" sub-layers are selected to have a particular thickness, where the thickness of each sub-layer is selected based on the design of the sub-floor, the number "n" of sub-layers and the material of each of the sub-layers. At step 140, the "n" individual sub-layers are bonded together. At step 150, the bonded sub-layers are bonded to a vinyl tile portion. At step 160, the vinyl tile is applied to the sub-floor.

[0039] While certain embodiments of the disclosure have been described herein, it is not intended that the disclosure be limited thereto, as it is intended that the disclosure be as broad in scope as the art will allow and that the specification be read likewise. Therefore, the above description should not be construed as limiting, but merely as exemplifications of particular embodiments. Those skilled in the art will envision additional modifications, features, and advantages within the scope and spirit of the claims appended hereto.

CLAIMS:

1. A vinyl tile, comprising:
a vinyl portion; and
an acoustical portion disposed adjacent the vinyl portion, the acoustical portion comprising a plurality of individual acoustical sub-layers each providing acoustical dampening at a different frequency;
wherein first and second sub-layers of the plurality of individual acoustical sub-layers comprise material compositions that are different from each other; and
wherein the plurality of individual sub-layers comprise materials selected from the list consisting of rubber, a mixture of cork and rubber, a mixture of rubber and polyurethane foam (PU), a mixture of PU foam and cork, and combinations thereof.
2. The vinyl tile of claim 1, wherein the first and second sub-layers have thicknesses that are different from each other.
3. The vinyl tile of claim 1, wherein the first and second sub-layers have thicknesses that are the same.
4. The vinyl tile of claim 1, wherein the first sub-layer comprises rubber and the second sub-layer comprises a mixture of rubber and cork.

5. The vinyl tile of claim 1, wherein the first sub-layer comprises a mixture of rubber and cork and the second sub-layer comprises rubber.
6. The vinyl tile of claim 1, wherein the plurality of individual sub-layers comprise three individual sub-layers.
7. The vinyl tile of claim 6, wherein the three individual sub-layers each comprises a material composition that is different from the other individual sub-layers.
8. The vinyl tile of claim 1, wherein the plurality of individual sub-layers comprise greater than three individual sub-layers.
9. A method of designing a vinyl tile to suit a particular flooring application, comprising:
 - determining a type of a sub-floor system that includes a floor/ceiling assembly to which a vinyl tile will be applied;
 - selecting an acoustical portion of said vinyl tile to include "n" sub-layers, where "n" is a number greater than 1 and is based on the type of said sub-floor; and
 - selecting a material composition for each of said "n" sub-layers, where the material composition for each of said "n" sub-layers is based on the type of said sub-floor system that includes the floor/ceiling assembly and the number "n" of sub-layers.

10. The method of claim 9, further comprising selecting a thickness for each of said "n" sub-layers, where the thickness for each of said "n" sub-layers is based on the type of said sub-floor system that includes the floor/ceiling assembly, the number "n" of sub-layers, and the material composition of each of said "n" sub-layers.

11. The method of claim 10, further comprising bonding the "n" individual sub-layers together to form said acoustical portion.

12. The method of claim 11, further comprising bonding the acoustical portion to a vinyl tile portion of said vinyl tile.

13. The method of claim 12, further comprising applying the vinyl tile to the sub-floor system that includes the floor/ceiling assembly.

14. A vinyl tile, comprising:

a vinyl portion; and

an acoustical portion comprising a plurality of individual acoustical sub-layers each providing acoustical dampening at a different frequency;

wherein first and second sub-layers of the plurality of individual acoustical sub-layers comprise material compositions that are different from each other; and

wherein the plurality of individual sub-layers comprise materials selected from the list consisting of rubber, a mixture of cork and rubber, a mixture of rubber and polyurethane foam (PU), a mixture of PU foam and cork, and combinations thereof.

15. The vinyl tile of claim 14, wherein the first and second sub-layers have thicknesses that are different from each other.

16. The vinyl tile of claim 14, wherein the first and second sub-layers have thicknesses that are the same.

17. The vinyl tile of claim 14, wherein the first sub-layer comprises rubber and the second sub-layer comprises a mixture of rubber and cork.

18. The vinyl tile of claim 14, wherein the first sub-layer comprises a mixture of rubber and cork and the second sub-layer comprises rubber.

19. The vinyl tile of claim 14, wherein the plurality of individual sub-layers comprise three individual sub-layers.

20. The vinyl tile of claim 19, wherein the three individual sub-layers each comprises a material composition that is different from the other individual sub-layers.

21. The vinyl tile of claim 14, wherein the plurality of individual sub-layers comprise greater than three individual sub-layers.

22. A vinyl tile, comprising:
- a vinyl portion; and
 - an acoustical portion disposed adjacent the vinyl portion, the acoustical portion comprising a plurality of individual sub-layers;
 - wherein the plurality of individual sub-layers comprise first, second and third individual sub-layers; and
 - wherein the first, second and third individual sub-layers each comprises a material composition that is different from the other individual sub-layers; and
 - wherein the first, second and third individual sub-layers comprise materials selected from the list consisting of rubber, a mixture of cork and rubber, a mixture of rubber and polyurethane foam (PU), a mixture of PU foam and cork, and combinations thereof.

1/6

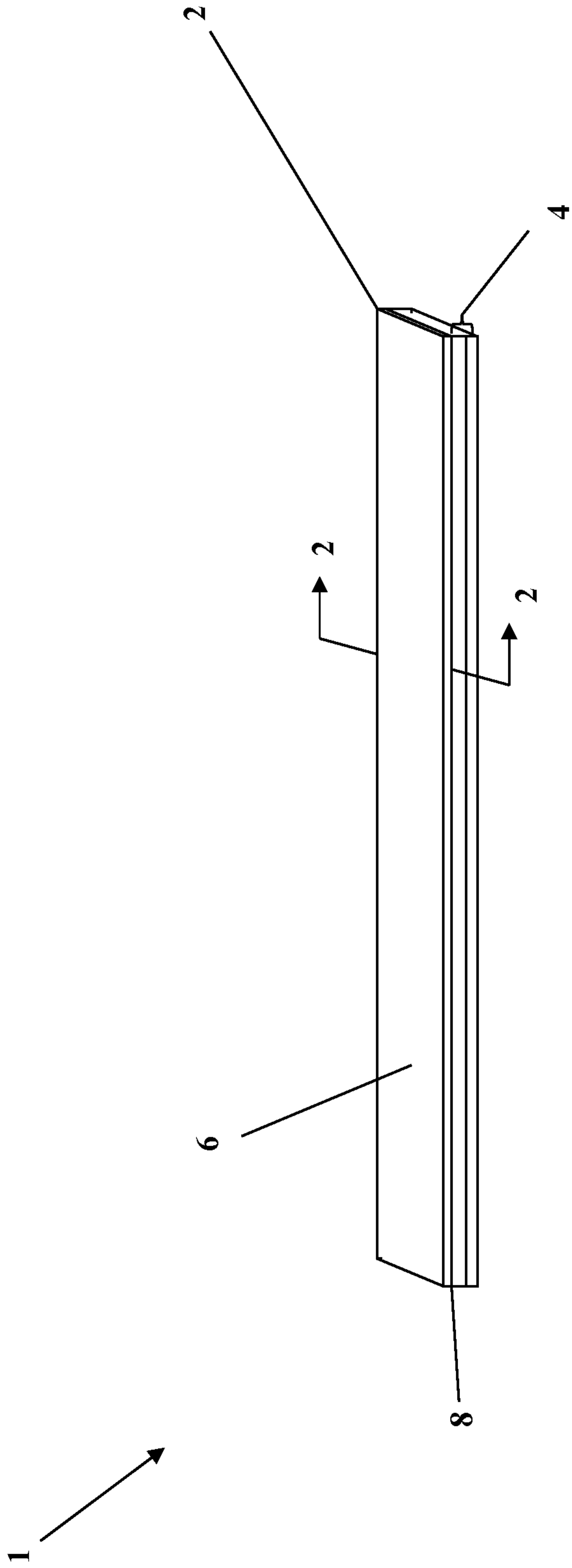

FIG. 1

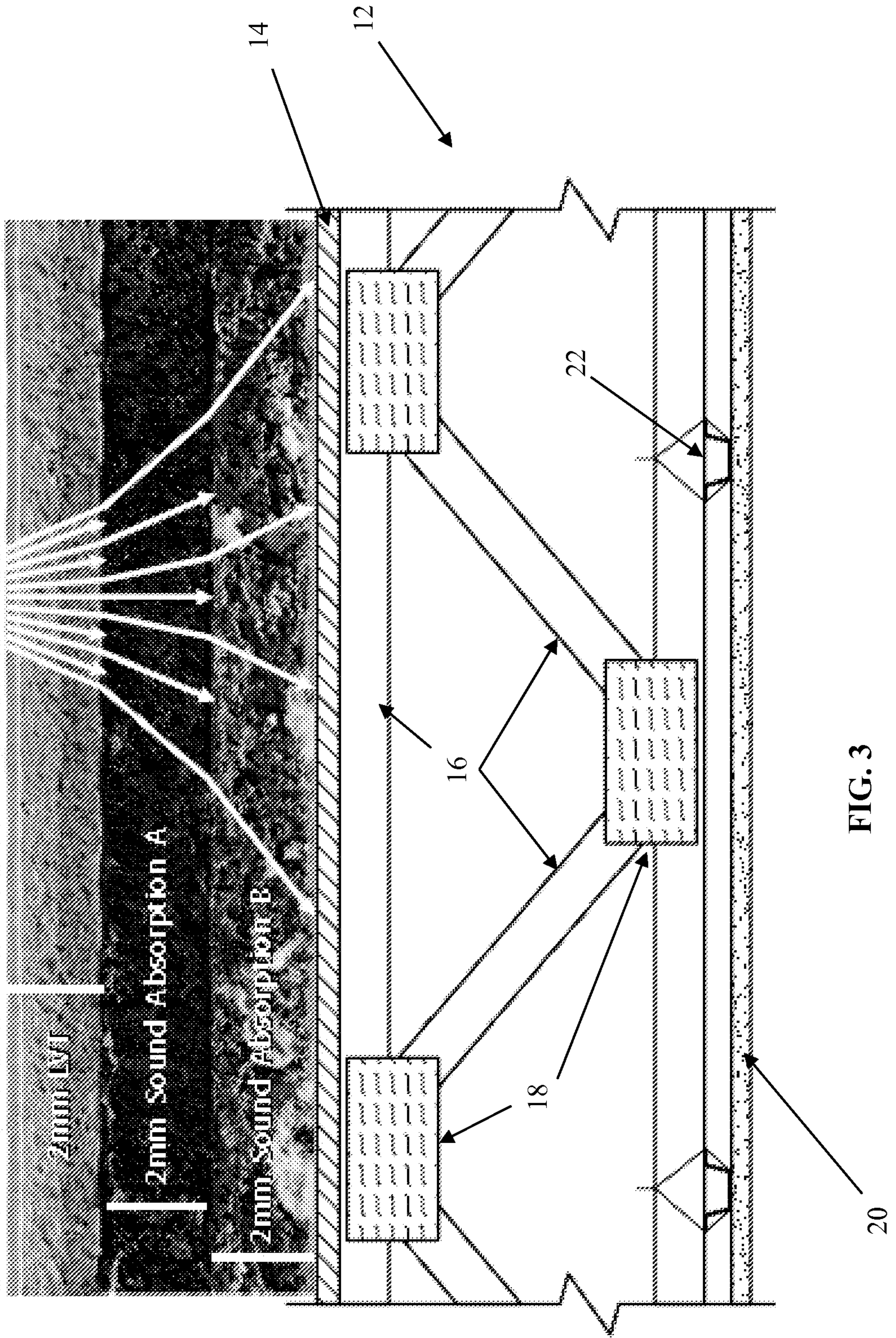
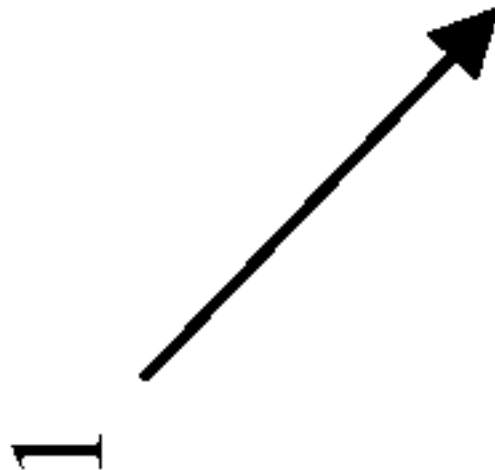

FIG. 3

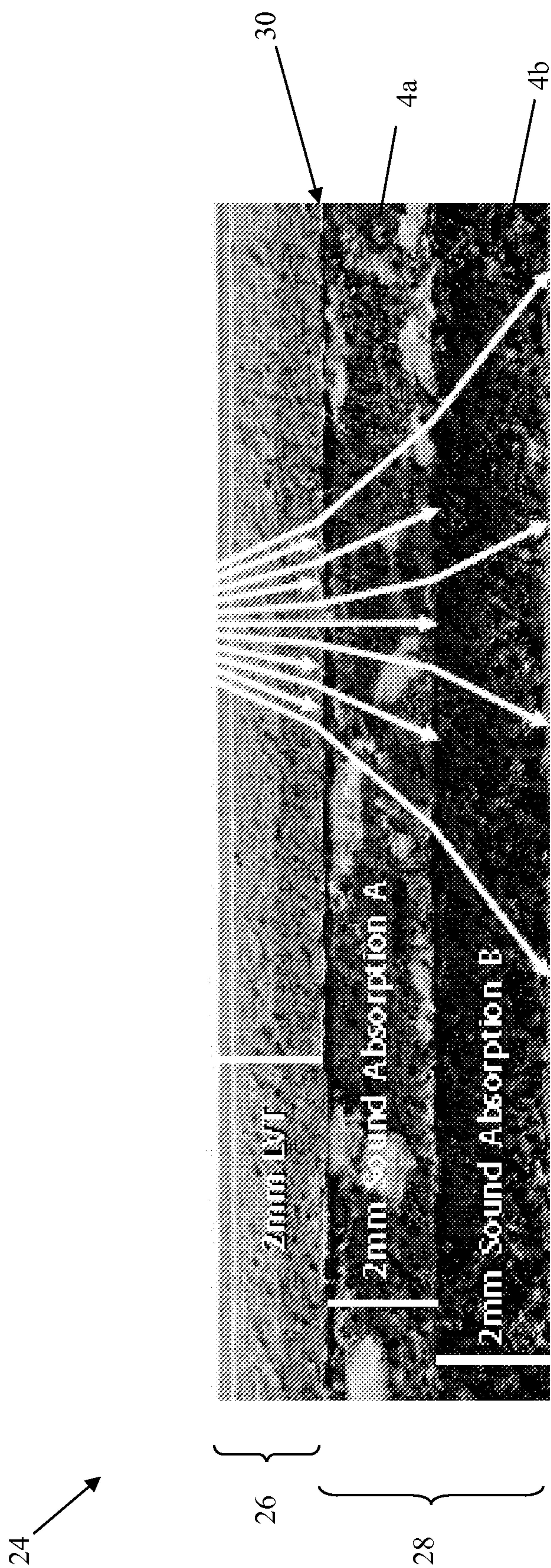

FIG. 4

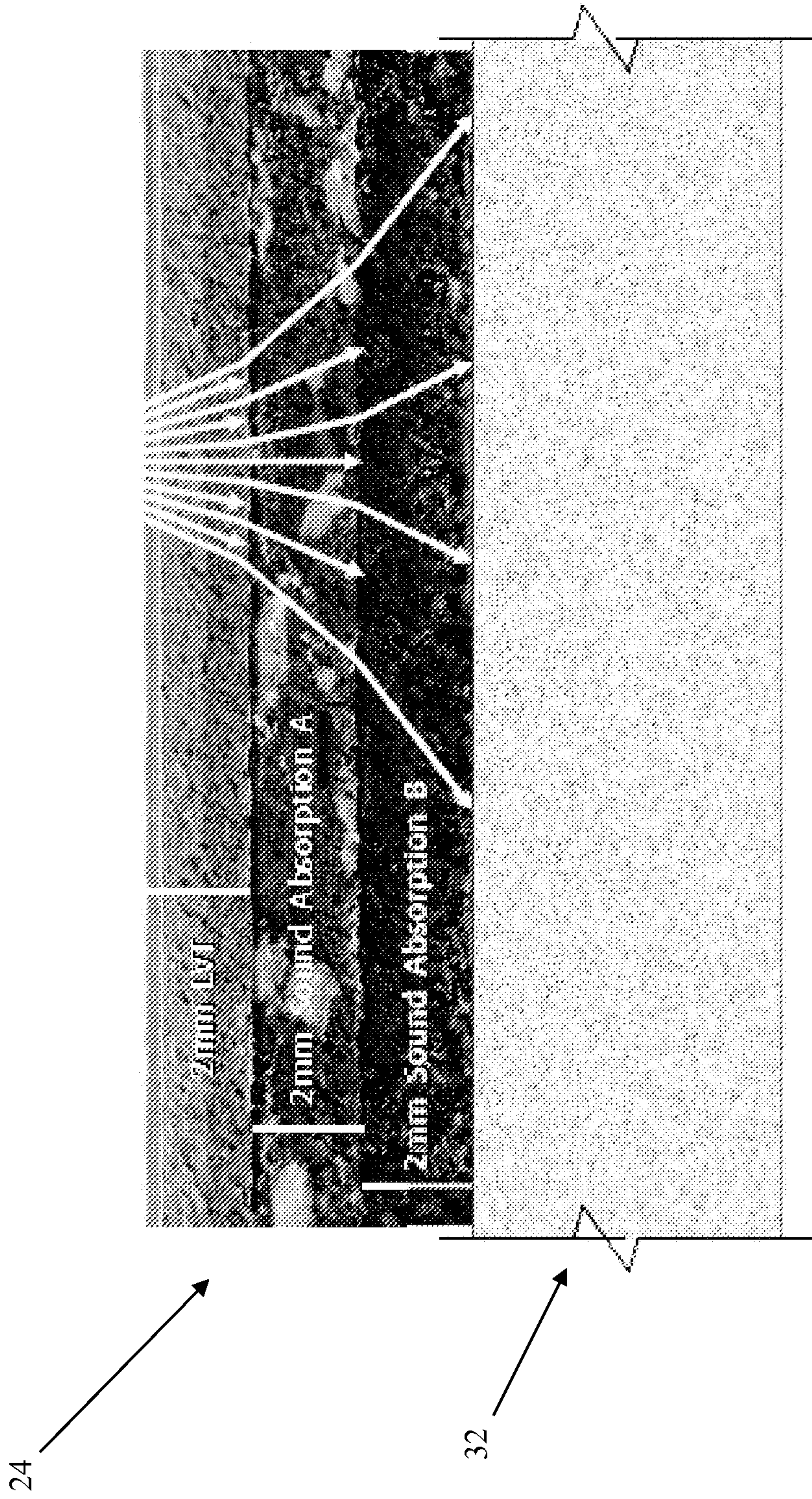

FIG. 5

6/6

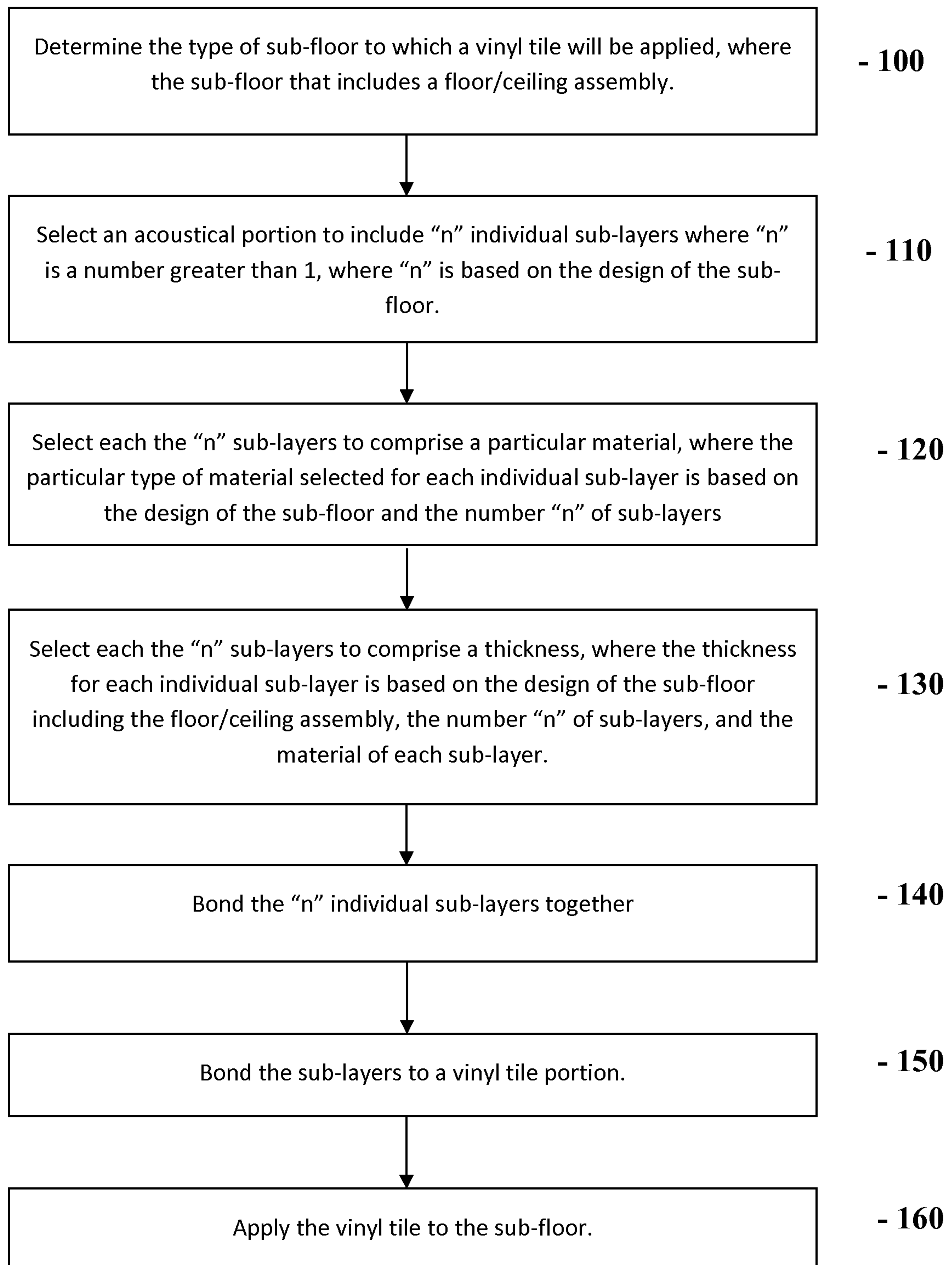

FIG. 6

