

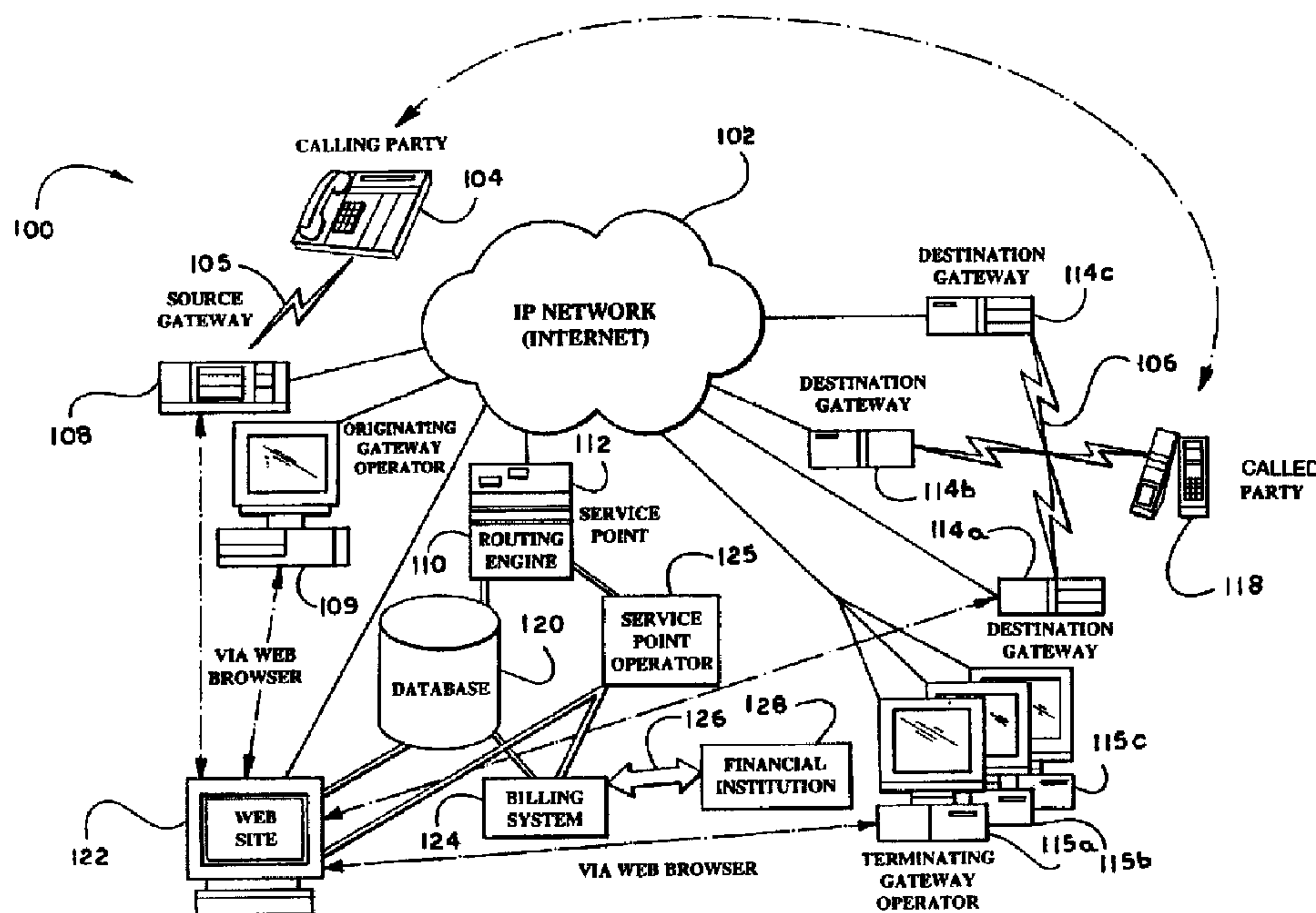

(86) Date de dépôt PCT/PCT Filing Date: 1998/09/16
 (87) Date publication PCT/PCT Publication Date: 1999/03/25
 (45) Date de délivrance/Issue Date: 2006/05/23
 (85) Entrée phase nationale/National Entry: 2000/03/14
 (86) N° demande PCT/PCT Application No.: US 1998/019254
 (87) N° publication PCT/PCT Publication No.: 1999/014931
 (30) Priorité/Priority: 1997/09/16 (US60/059,087)

(51) Cl.Int./Int.Cl. *H04M 7/00* (2006.01),
H04N 1/327 (2006.01), *H04M 3/38* (2006.01),
H04L 12/66 (2006.01), *H04L 12/64* (2006.01),
H04L 29/06 (2006.01), *H04L 25/06* (2006.01),
H04M 15/00 (2006.01)
 (72) Inventeurs/Inventors:
 DALTON, JAMES PLEASANT GOSSETT JR., US;
 DALTON, ALCINA DE FIGUEIREDO, US;
 THOMAS, STEPHEN ANTHONY, US;
 COWN, MARIA OSTERHOLT, US;
 VAUGHN, RICH CARROLL, US;
 SZCZARBINA, PAWEL, US;
 LOVETTE, BRIAN KEITH, US
 (73) Propriétaire/Owner:

(54) Titre : DISPOSITIF D'ACHEMINEMENT DE COMMUNICATIONS TELEPHONIQUES SUR L'INTERNET
 (54) Title: INTERNET TELEPHONY CALL ROUTING ENGINE



(57) Abrégé/Abstract:

The present invention discloses a centralized routing engine that is able to assist gateways in making routing decisions for calls being placed in an IP network environment. Types of calls include voice, fax, video, etc. The routing engine provides significant flexibility to the gateways by allowing the gateways to designate preferences that define operational limits or requirements. A source gateway operator may set preferences such as the maximum price that is willing to be paid for a call, the maximum delay that will be tolerated and the maximum autonomous system hop count that will be tolerated. A destination gateway operator is likely only to be concerned with setting price schedules as preferences. Gateway operators may also set "preference criteria", which define the circumstances in which a certain set of preferences is to be applied. Based on preferences and preference criteria, the routing engine is able to locate destination gateways that are eligible to terminate a voice over telephony IP call. The routing engine provides a prioritized list of eligible destination gateways to the source gateway. The source gateway then works through the prioritized list and attempts to set up the voice over IP telephony call with each eligible destination gateway, until the call is established.

(73) Propriétaires(suite)/Owners(continued):TRANSNEXUS, LLC, US

(74) Agent: FINLAYSON & SINGLEHURST



PCT

WORLD INTELLECTUAL PROPERTY ORGANIZATION
International Bureau

INTERNATIONAL APPLICATION PUBLISHED UNDER THE PATENT COOPERATION TREATY (PCT)

<p>(51) International Patent Classification ⁶ : H04M 7/00, H04L 12/66</p>	<p>A2</p>	<p>(11) International Publication Number: WO 99/14931 (43) International Publication Date: 25 March 1999 (25.03.99)</p>
<p>(21) International Application Number: PCT/US98/19254 (22) International Filing Date: 16 September 1998 (16.09.98) (30) Priority Data: 60/059,087 16 September 1997 (16.09.97) US (71) Applicant: TRANSNEXUS, LLC [US/US]; Suite N-204, 430 Tenth Street, N.W., Atlanta, GA 30318 (US). (72) Inventors: DALTON, James, Pleasant, Gossett, Jr.; 3300 Wood Valley Drive Road, Atlanta, GA 30327 (US). DALTON, Alicia, de Figueiredo; 3300 Wood Valley Road, Atlanta, GA 30327 (US). THOMAS, Stephen, Anthony; 4397 Windsor Oaks Circle, Marietta, GA 30066 (US). COWN, Maria, Osterholt; 2854 Betula Drive, Austell, GA 30106 (US). VAUGHN, Rich, Carroll; 4383 Burnleigh Chase, Roswell, GA 30075 (US). SZCZERBINA, Pawel; 795 Hammond Drive #1604, Atlanta, GA 30328 (US). LOVETTE, Brian, Keith; 2540 Ingram Road, Duluth, GA 30136 (US). (74) Agents: PAVENTO, Michael, S. et al.; Jones & Askew, LLP, 37th floor, 191 Peachtree Street, N.E., Atlanta, GA 30303 (US).</p>	<p>(81) Designated States: AL, AM, AT, AU, AZ, BA, BB, BG, BR, BY, CA, CH, CN, CU, CZ, DE, DK, EE, ES, FI, GB, GE, GH, GM, HR, HU, ID, IL, IS, JP, KE, KG, KP, KR, KZ, LC, LK, LR, LS, LT, LU, LV, MD, MG, MK, MN, MW, MX, NO, NZ, PL, PT, RO, RU, SD, SE, SG, SI, SK, SL, TJ, TM, TR, TT, UA, UG, UZ, VN, YU, ZW, ARIPO patent (GH, GM, KE, LS, MW, SD, SZ, UG, ZW), Eurasian patent (AM, AZ, BY, KG, KZ, MD, RU, TJ, TM), European patent (AT, BE, CH, CY, DE, DK, ES, FI, FR, GB, GR, IE, IT, LU, MC, NL, PT, SE), OAPI patent (BF, BJ, CF, CG, CI, CM, GA, GN, GW, ML, MR, NE, SN, TD, TG).</p> <p>Published <i>Without international search report and to be republished upon receipt of that report.</i></p>	

(54) Title: INTERNET TELEPHONY CALL ROUTING ENGINE

(57) Abstract

The present invention discloses a centralized routing engine that is able to assist gateways in making routing decisions for calls being placed in an IP network environment. Types of calls include voice, fax, video, etc. The routing engine provides significant flexibility to the gateways by allowing the gateways to designate preferences that define operational limits or requirements. A source gateway operator may set preferences such as the maximum price that is willing to be paid for a call, the maximum delay that will be tolerated and the maximum autonomous system hop count that will be tolerated. A destination gateway operator is likely only to be concerned with setting price schedules as preferences. Gateway operators may also set "preference criteria", which define the circumstances in which a certain set of preferences is to be applied. Based on preferences and preference criteria, the routing engine is able to locate destination gateways that are eligible to terminate a voice over telephony IP call. The routing engine provides a prioritized list of eligible destination gateways to the source gateway. The source gateway then works through the prioritized list and attempts to set up the voice over IP telephony call with each eligible destination gateway, until the call is established.

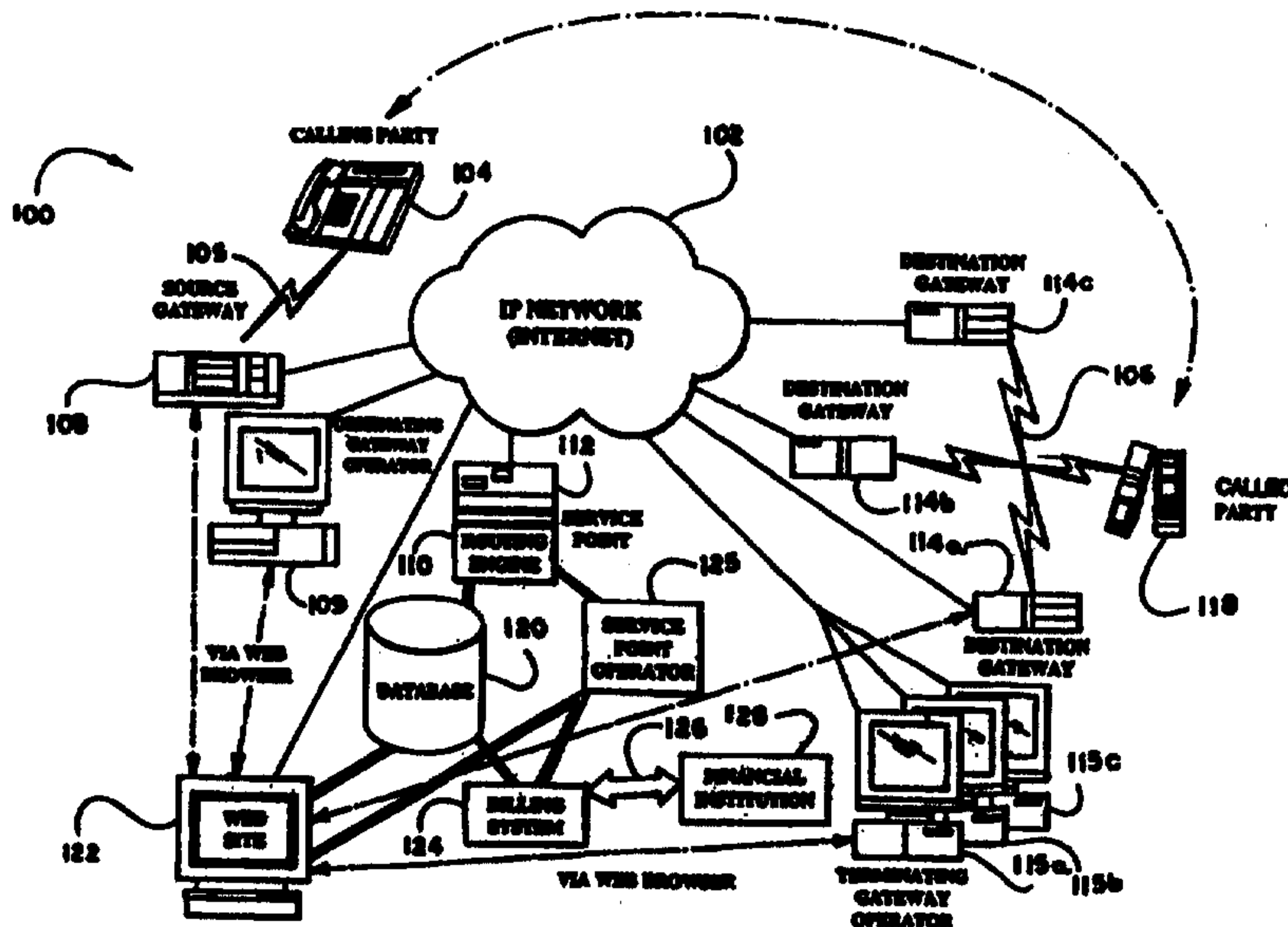

INTERNET TELEPHONY CALL ROUTING ENGINE

Technical Field

The present invention generally relates to voice over IP communications. More particularly, the present invention relates to a routing engine to assist in the routing of voice over IP communications from a source gateway to a destination gateway.

Background of the Invention

As an alternative to traditional switched circuit networks, telecommunications service providers have discovered

that voice telephone calls may be routed over IP networks. Due to the fact that the Internet is not presently subject to the same international regulations as are traditional telephone networks, routing telephone calls over the Internet tends to be less expensive. Additionally, an IP routed voice telephone call requires much less bandwidth, and thus less cost, than a voice telephone call placed over a traditional telephone network. Further, IP technology advances and is entered into the marketplace at a much faster rate than traditional telecom technology. Thus, in order to be competitive, telecommunications service providers have begun to use IP routing as a way to offer customers access to the latest technological improvements.

For multi-media communications completed via local area networks, the International Telecommunications Union (ITU) has issued Recommendation H.323 entitled "Visual Telephone Systems and Equipment for Local Area Networks which provide a Non-Guaranteed Quality of Service." The H.323 Recommendation provides system and component descriptions, call model descriptions, and call signaling procedures. An H.323-compatible terminal can provide real-time bi-directional audio, video, and data communications. An H.323-compatible gateway can provide translations of call signaling, control channel messages, and multiplexing techniques between an H.323 terminal and other ITU terminal types. An H.323-compatible gatekeeper can support network administration to control the amount of video

2a

telephony traffic on the computer network and can provide address translation services. However, the H.323 Recommendation does not provide any mechanisms for guaranteeing the quality of service for a video telephony call over the computer network. The H.323 Recommendation anticipates that global multi-media communications can be achieved by using H.323 terminals and the Internet for connectivity.

Presently, however, there is no centralized system for routing voice telephone calls over an IP network. Each operator of a gateway is responsible for determining the routes for its own outgoing calls. Typically, gateway operators rely on traditional IP routing algorithms, which are designed to handle routing of computer generated data packets. Traditional IP routing algorithms attempt to strike a balance between the concerns of minimum delay and maximum reliability. Thus, using traditional IP routing algorithms, a voice telephone call will be routed to any destination gateway that happens to satisfy a set of predetermined shortest path and acceptable data loss parameters.

The routing of voice telephone calls, however, involves a significant concern that is not shared by traditional IP routing algorithms. This additional concern is the monetary cost of routing a voice call to a particular destination gateway. As in traditional switched circuit networks, Internet telephony gateways impose fees for the service of terminating a voice call. Traditional IP routing

AMENDED SHEET

algorithms are not able to detect and compare the varying price schedules that may be imposed by various Internet telephony gateways. Thus, source gateways are not able to discriminate between destination gateways based on monetary costs.

5 Thus, there remains a need in the art for voice over IP routing that is able to balance financial concerns with concerns for minimum delay and maximum reliability.

 There also remains a need in the art for a centralized system for assisting gateway operators with routing decisions.

10

Summary of the Invention

 The present invention relates to a routing engine connected to an IP network, such as the Internet, that provides gateways with assistance in the routing and billing of voice over IP transactions. The novel routing engine provides a source gateway with a prioritized list of destination gateways that are eligible to terminate a voice telephone call. The routing engine locates eligible destination gateways by gathering and matching information relating to "preferences" from various gateway operators. For a source gateway, preferences may be the maximum price that will be paid for a given call, the maximum delay that will be tolerated for the call and the maximum autonomous system hop count that will be tolerated. For a destination gateway operator, the most relevant preference is the price charged for access to the destination gateway.

15

20

25

 Gateway operators may also designate "preference criteria," which define the circumstances in which a given set of preferences are to apply. Preference criteria may relate to the identification of a particular gateway, a particular called number

prefix, a particular time of day and/ or day of the week. Thus, for example, a source gateway operator may specify that all calls place from a particular source gateway will only tolerate a stated amount of delay and will only incur a set amount of costs. Also, a
5 destination gateway operator may specify that a certain price will be charged for access to a certain gateway at a certain time of day, or for calls placed to a specific geographic region, or even for calls placed to a specific telephone number. Routing, and thus billing, flexibility is virtually limitless due to the designation of
10 preferences and preference criteria.

Gateway operators designate preferences and preference criteria through a web-site that is related to the routing engine, or through other electronic transfer means. The preferences and preference criteria are then transferred to a centralized database
15 that is accessible to all routing engines that may be distributed around an IP network. Geographically distributed routing engines are desirable in order to handle requests for routing assistance from geographically diverse gateways. Additionally, at a given location, a scalable number of routing engines may be coupled together, so
20 as to process a multitude of routing requests with speed and efficiency.

Thus, it is an object of the present invention to provide routing that is able to account for financial concerns as well as signal delay and quality of communications service. It is a further
25 object of the present invention to provide a centralized service point to assist gateways in the process of making voice over IP routing decisions .

These and yet other objects, features and advantages of the present invention will become apparent from reading the

following specification, taken in conjunction with the accompanying drawing.

Brief Description of the Drawing

5 FIG. 1 is a schematic representation of an exemplary operating environment for the present invention;

 FIG. 2 provides an overview of the steps involved in an Internet telephony call in the exemplary operating environment;

10 FIG. 3 provides an example of the device activation process for a device running the Win32 platforms;

 FIG. 4 provides a detailed picture of an exemplary activation server as a part of the exemplary operating environment;

 FIG. 5 illustrates the steps involved in the activation of a UNIX-based source gateway;

15 FIG. 6 shows the general architecture of a service point;

 FIG. 7 illustrates the overall message flow within a service point;

20 FIG. 8 illustrates an exemplary database table for storing information relating to a source gateway;

 FIG. 9A describes an exemplary method by which a routing engine may access a database table to locate preferences for a source gateway;

 FIG. 9B is a continuation of FIG. 9A;

25 FIG. 10 illustrates an exemplary database table for storing information relating to a destination gateway;

 FIG. 11A shows an exemplary method that may be used by a routing engine to locate eligible gateways in a database table;

FIG. 11B is a continuation of FIG. 11A;

FIG. 11C is a continuation of FIG. 11B;

FIG. 12 describes the internal architecture of an exemplary routing engine.

5

Detailed Description of the Exemplary Embodiments

The present invention relates to a routing engine for routing telephony calls from a source gateway to a destination gateway via an IP network. A telephone call occurring via an IP network is often referred to as a "voice over IP" transaction. When a "voice over IP" transaction specifically involves the Internet, the description "Internet telephony" may also be used to describe the transaction. An exemplary embodiment of the routing server will be described with respect to Internet telephony. However, the principles of the routing engine of the present invention apply to all IP routed transactions, including, but not limited to, "voice over IP" calls, "fax over IP" calls, and "video over IP calls."

Exemplary Operating Environment

The following description of an exemplary operating environment and exemplary embodiments of the present invention will refer to the drawing, in which like numerals indicate like parts throughout the several figures. Referring thereto, FIG. 1 shows a network architecture that serves as an exemplary operating environment for the routing engine of the present invention. As indicated, the Internet **102** serves as the heart of the exemplary network architecture. Relying on the Internet **102** are five different systems that might participate in an Internet Telephony transaction. These five systems include: a calling party **104**, a source gateway

(also referred to as an originating gateway) **108**, a service point **112** including a routing engine **110**, a destination gateway (also referred to as a terminating gateway) **114** and a called party **118**. As FIG. 1 shows, a service point **112** is coupled to a central database **120**,
5 which is also coupled to a billing and settlement system **124**. While the service point **112** exists on the public Internet **102**, the central database **120** and the billing and settlement system **124** remain in secured facilities. Private communication paths connect the remote equipment with the central database **120**.

10 The calling party **104** represents the user wishing to place a telephone call. Often, the calling party **104** will rely on a standard telephone handset to place the call. In fact, in many cases the calling party **104** may not be able to distinguish Internet telephony service from standard telephone service. The calling
15 party **104** connects to a source gateway **108** through a public telephone network **105**, such as a switched circuit network. In either case, the source gateway **108** serves as a bridge between ordinary telephones and the Internet **102** by converting telephone signals into data packets (and vice versa) and transmitting the data
20 packets over the Internet **102**. A source gateway is operated by a source gateway operator **109**.

Similarly, the called party **118** is the user that receives a telephone call. A called party **118** connects to a destination gateways **114** through a public telephone network **106**, such as a
25 switched circuit network. A destination gateway **114** is connected to the Internet **102** at a location that is remote from the source gateway **108**. The destination gateway **114** is operated by a destination gateway operator **115** and performs the same functions as the source gateway **108**, i.e., bridging phone calls between the

Internet 102 and a public telephone network 106, or an equivalent thereof. Destination gateways 114 differ from source gateways 108 only in the role played in a particular call. In particular, source gateways 108 act on behalf of the calling party 104, while
5 destination gateways 114 act on behalf of the called party 118. It is important to note that the same operator need not manage both the source gateway 108 and the destination gateway 114. In fact, the exemplary routing engine 110, is tailored for environments in which different owners operate the two types of gateways.

10 The service point operator 125 may be a third party that is independent of the operators of the source gateway 108 or destination gateways 114. As indicated in FIG. 1, the service point operator may maintain a private communications line with the service point 112, the billing and settlement system 124 and a
15 related web-site 122. In the exemplary operating environment, all components maintained by the service point operator 125, i.e., the service point 112, the database 120, the billing and settlement system 124 and the web-site 122, are conveniently distributed between various geographic locations. Still, those skilled in art
20 will appreciate that all components maintained by the service point operator 125 may be incorporated in a single system (service point 112) or any number of distributed systems.

A service point 112 communicates with gateways over the Internet 102 and generally provides routing information to the
25 source gateway 108. Given a destination phone number and other requirements (described in detail below), the service point 112, through the routing engine 110, identifies at least one appropriate destination gateway 114 to handle the telephone call.

The overall network architecture that serves as an operating environment for the exemplary routing engine **110** may be thought of as comprising three different networks, each carrying the telephone conversation. The first network is the calling party's telephone network **105** that connects the calling party to the source gateway **108**. The second network is the Internet **102**, which connects the source gateway **108** and the destination gateways **114** to each other. The third network is the called party's telephone network **106**, which completes the connection from the destination gateway **114** to the called party **118**. Although FIG. 1 (as well as this description in general) refers to the telephone connections as taking place through public telephone networks **105** and **106**, Internet telephony service does not require such a connection. Some applications may use private networks, such as those provided by a private branch exchange; others may simply connect telephone handsets directly to the corresponding gateway.

Additionally, a fourth network may be added to the general network architecture. The fourth network is a banking and funds transfer network **126**. A billing and settlement system **124** may be coupled to the service point **112** in order to receive information relating to the financial aspects of the Internet telephony transactions. The billing and settlement system **124** may use a banking and funds transfer network **126** to execute the financial transactions coordinated by the service point **112**.

FIG. 2 provides an overview of an Internet telephony call in the exemplary operating environment. At step **201**, an Internet telephony call is initiated when the calling party **104** dials a telephone number, which is transmitted to the source gateway **108** for processing. The goal of the source gateway **108** is to locate

a destination gateway **114a-c** that is able to terminate the phone call. The source gateway **108** relies on the service point **112** for routing assistance.

At step **202**, the source gateway **108** makes an authorization request to a service point **112**. The authorization request indicates, among other things, the telephone number of the called party **118**. At the service point **112**, the routing engine **110** uses information in the authorization request, as well as preferences established for the source gateway's **108** cost and quality requirements, to determine which of the destination gateways **114a-c** are eligible to complete the call.

At step **203**, the service point **112** then sends an authorization response message to the source gateway **108**, which includes information relating to the identity of eligible destination gateways **114**. In addition, the authorization response message contains an authorization ticket for access to each eligible destination gateway **114**. The authorization response ticket allows a destination gateway **114** to accept the call knowing that it has been authorized by the service point **112**, and that the service point operator **125** will compensate the destination gateway operator **115** for completing the call.

Upon receipt of the authorization response message, the source gateway **108** selects a destination gateway **114** from among the list provided by the service point **112**. At step **204**, the originating gateway **108** then sends a setup message to the selected destination gateway **114**, as specified in International Telecommunications Union (ITU) H.323 and associated standards. Those skilled in the art will recognize that the Q.931 standard may be used to define the setup message. To complete the

authorization, the setup message must include the authorization ticket for the destination gateway **114**. Those skilled in the art will also recognize that the user-to-user information element of the Q.931 setup message may be used to convey the authorization
5 ticket.

Communication between the service point **112**, the source gateway **108** and the destination gateways **114** does not require the use of standard protocols for any aspect of the Internet telephony calls themselves, including call setup. If the source
10 gateway **108** and destination gateways **114** use a signaling protocol other than Q.931 (which is specified by H.323 and H.225.0), then that protocol need only be capable of including the authorization ticket in the initial setup message. The exemplary authorization ticket is approximately 2000 octets in length. Destination
15 gateways **114a-c** may accept or reject Internet telephony calls based on the presence and contents of this authorization ticket.

After the Internet telephony call is completed, both the source gateway **108** and the destination gateway **114** transmit a call detail report to the service point **112**, as represented in steps **205**
20 and **206**. Call detail reports identify the call and record its duration. Call detail reports are stored in the database **120** and are accessed by the billing and settlement system **124** in order to reconcile financial obligations between the service point operator **125**, source gateway operators **109** and destination gateway
25 operators **115**.

It should be noted that source gateway **108** and destination gateways **114** are free to establish connections without consulting a service point **112**. For example, a group of gateways may all be owned by a common entity and may wish to exchange

calls among themselves independent of a service point 112. In such an environment, the gateways are free to rely on a service point 112 only when no gateway in the group can serve a given phone number economically. Thus, the exemplary operating environment provides gateways with extremely flexible routing choices.

Also, those skilled in the art will appreciate that the exemplary operating environment may include multiple service points 112. Service points may be distinguished by the specific services they provide, as well as by their geographic location on the Internet 102. Geographic diversity optimizes performance by allowing a device to communicate with the closest service point 112. Proximity to a service point 112 minimizes delay in the communication exchange. Geographic diversity also increases the reliability of the operating environment. If one service point 112 becomes unavailable, devices using that service point 112 can automatically switch to a different service point (not shown) located elsewhere.

Before a gateway is provided with access to a service point 112 the responsible gateway operator must enroll as a customer of the service point operator 125. The customer enrollment process may take place through the web-site 122, via the Internet 102, using any well-known web browser. Gateway operators 109 & 115 typically perform the enrollment from a desktop computer. Since the enrollment process typically requires disclosure of sensitive financial information (such as bank accounts or credit card numbers), the web connection between the gateway operators 109 & 115 and the web-site 122 is secured by the secure sockets layer (SSL) protocol. The web-site 122 uses SSL to

authenticate itself to gateway operators **109 & 115** with digital certificates obtained from a trusted certificate authority. SSL also encrypts the information transferred between the gateway operators **109 & 115** and the web-site **122**.

5 When the service point operator **125** accepts a gateway operator as a customer, it provides the customer with a customer number and password. The customer number is Hamming coded to protect against corruption. Once assigned, customers are allowed to change their password. The service point
10 operator **125** may enforce certain restrictions on passwords to maximize security. Such restrictions may include, for example, a prohibition against words appearing in dictionaries, a requirement to use both upper and lower case characters and a requirement that customers change their password periodically.

15 After enrollment is complete, gateway operators **109 & 115** are given authorization to access and modify their accounts, via the Internet **102**, through the web-site **122**. Enrolled customers may also be provided with access to timely and informative reports on their usage of a service point **112**. Such reports may include up-
20 to-the-minute billing information, potential fraud alerts, sophisticated usage statistics and detailed traffic profiles. Enrolled users may access these reports directly through the web-site **122**, using a web browser, or they can download the information for importing into their own database or spreadsheet. Users may also
25 elect to be notified via electronic mail, fax, or other means when certain events occur. Events eligible for this service include suspicious or fraudulent activity, minimum or maximum traffic levels at particular devices, and apparent failure of a device.

An enrolled customer may activate individual devices to use the services provided by a service point 112. In the present discussion, the exemplary devices are Internet telephony gateways 108 & 114. However, those skilled in the art will appreciate that the exemplary operating environment may be configured to supports a wide variety of devices. As with operator enrollment, device activation takes place across the Internet 102 using well-known web browsers. Typically, device activation will take place at the device itself, while operator enrollment is performed from an operator's personal computer or workstation.

A web-site 122 may be configured to support several different approaches for activating devices, depending on the particular type of device. In all cases, though, a device becomes activate through a three-step process. First the device generates a public/private key pair and stores the private key securely. Next the device forwards the public key to the web-site 122 through a certificate request. Last, the web-site 122 provides a certificate to the device validating the public key. The detailed implementation of this three-step device activation process varies depending on the operating environment of a particular device. A web-site 122 may be configured to support Windows, UNIX, and embedded operating environments. Those skilled in the art will recognize that other operating systems may also be supported.

With respect to the Windows operating environment, exemplary web-site 122 may be designed to support the operating environments of Windows 95, Windows 98 and Windows NT version 4.0 and later (collectively referred to as "Win32 platforms"). For these operating environments, reliance may be placed heavily on Microsoft's Internet Explorer (version 3.02 and

later) to generate key pairs and to request and install certificates. The Certificate Server component of Microsoft's Internet Information Server version 4.0 may be used to grant certificate requests.

5 FIG. 3, shows an example of the activation process for a device running the Win32 platforms. The two systems involved in the communication are the device being activated, i.e. source gateway **108**, and an activation server **310** (also known as a certificate server) running as part of the web site **122**. As indicated
10 at step **301**, the user of the source gateway **108** must first navigate to the appropriate part of the web site **122**, such as a device activation page. Users may be prompted to provide authentication information to access a device activation page. In addition to HTML-formatted instructions, the device activation page
15 downloads an ActiveX control, as shown as step **302**. This control is digitally-signed by a trusted object-signing authority. When triggered by appropriate user interaction with the HTML form at step **303**, the control causes the device to generate a public/private key pair at step **304**, build a certificate request and forward that
20 request at step **305** to the activation server **310**.

The ActiveX control relies on the version 2.0 of the Crypto API interface, available on Win32 platforms, for cryptographic algorithms and certificate management. Optimally, the control will use the strongest cryptographic algorithms
25 available on the platform. For example, if the source gateway **108** has installed Microsoft's enhanced cryptographic service provider, then the control will use its cryptographic services. In the absence of other services, the control will use Microsoft's base

cryptographic service provider. If no cryptographic services are available in the device, device activation is not possible.

Certificate requests follow the format defined by RSA laboratories in Public Key Cryptography Standard (PKCS) number 5 10. At step 306, the activation server grants the request and returns a certificate for the device (source gateway 108). The certificate conforms to the International Telecommunication Union X.509 version 3 standard. Optimally, certificates issued by the activation server 310 will include the "subjectAltName" extension, marked as 10 critical. That extension encodes both the customer and device number in ASCII text. The exemplary format for the data is "Customer=nnnnnnn, Device=mmmmmm" where nnnnnnn is the customer number and mmmmmm is the device number. Device numbers, like customer numbers, are generated by the service point 15 operator 125 and are Hamming coded to protect against corruption.

Although shown in FIG. 3 as a single system, the activation server 310 may actually consist of multiple components. FIG. 4 provides a more detailed picture of an exemplary activation server 310. Note that the actual activation server 310 is isolated 20 from the Internet 102 by a firewall 404. Web servers 406 outside the firewall provide the web-site 122, but these web servers 406 must contact the activation server 310 through the firewall 404 to generate certificates. The activation server 310 stores copies of the certificates in a Open Database Connectivity (ODBC) accessible 25 database 120. The database 120 can redistribute certificates and certificate revocation lists (CRLs) to a service point 112 (where they are used to authenticate devices and authorize communications) as well as to public LDAP-compliant directories 410. The public directories let customers of the service point

operator **125** use certificates for additional security services such as gateway-to-gateway authentication and encryption.

UNIX-based devices cannot, in general, rely on the services of ActiveX controls and Internet Explorer for device
5 activation. Instead, as shown in FIG. 5, at step **501**, such devices must download binary software from the web site **122**. Such software may be optimized for several popular UNIX variants. To prevent unauthorized use of the software, the user's customer number, a generated device number, and a relatively short time
10 limit (for example 15 minutes) are added to the software just prior to download at step **502**. The software is then digitally signed at step **503** and distributed to the Unix-based device (gateway) at step **504**. The precautions taken in the distribution of activation software effectively make the software a single-use program.
15 Thus, the activation software cannot be re-distributed and used on other devices.

As an example, the activation software may include cryptographic software from RSA laboratories. In particular, the BSAFE 3.0 for cryptographic algorithms and BCERT 1.0 for
20 certificate management software programs may be used. The activation server **310** may also be configured to automatically verify the physical location of a device with reverse Domain Name Service (DNS) and "whois" lookups. In cases where it is not possible to provide cryptographic software at all, for example due
25 to import restrictions, device activation is not possible. Once downloaded, however, the activation program generates a key pair, formats a certificate request, and forwards that request to the activation server. The same activation server **310** may support both Windows and UNIX devices.

The web-site **122** may also be configured to support devices using embedded operating systems such as Cisco's Internetwork Operating System (IOS), WindRiver's VxWorks and others. To the extent that an embedded operating system can support standard UNIX services, it may use the approach outlined above for UNIX environments. Rather than supply downloadable binary programs for embedded environments, the web-site **122** may provide source code licenses to vendors using embedded environments. The method for embedding customer number and device number in that software may be defined on a case-by-case basis with each vendor.

Once enrolled customers have activated their devices (gateways), the devices can begin using the service to help complete their Internet telephony transactions. As mentioned, an Internet telephony transaction is initiated when a calling party **104** dials the telephone number of a called party **118**. The dialed telephone number is transmitted to the source gateway **108** for processing. The source gateway **108** must then locate a service point **112** that will provide routing assistance for the telephone call. As noted previously, several services points **112** may be connected to the Internet **102** to provided geographic diversity.

In the exemplary operating environment, service points **112** share a primary DNS name (such as "routing.transnexus.com.") Thus, source gateway **108** or other device may locate a service point **112** by simply attempting to communicate with the appropriately named system. Using DNS names allows for the use of technology such as Cisco's Distributed Director. When a source gateway **108** or other device requests a DNS lookup of a particular name, the Director automatically

supplies the IP address of the service point 112 nearest the requesting device. By communicating with the nearest service point 112, devices experience the minimum delay in accessing a service point 112. In case the Distributed Director technology is unavailable, devices may also be configured with a list of specific names for individual service points 112.

Specific names for individual service points may be of the form "us.routing.transnexus.com," "routing.transnexus.co.uk," and "routing.transnexus.co.jp," where one component of the name indicates the service point's 112 location. Devices (gateways) should also be manually configured with their own current location, so that they can prioritize eligible service points 112 by proximity. A device can then try to contact each service point 112, in turn, until communication is successful.

Once the source gateway 108 finds a service point 112, it may access the services provided by the service point 112. Service points 112 allow at least three forms of access. Hypertext Transfer Protocol (HTTP) is available for all types of service. Voice and fax services have two additional options, namely gatekeeper access and gatekeeper-routing.

When any device attempts to contact a service point 112, using either HTTP or H.323 protocols, the service point 112 authenticates that device before providing service. Authentication

relies on public key cryptography, most specifically the public / private key created during device activation, as described above. All messages from devices are digitally signed, using the device's private key. The message may also include a certificate validating the device's public key. A service point 112 obtains the device's public key, either from the included certificate (in which case it then verifies the certificate's signature), or directly from a certificate store. The public key permits verification of the signature.

10 The exemplary service point 112 architecture provides for flexible and scalable authentication services. As FIG. 6 shows, each service point 112 consists of a number of authentication servers 602. The authentication servers 602 are protected by a screening firewall 604, while a local redirector 606 provides load
15 balancing and fault tolerance among the authentication servers 602. All service points 112 preferably include at least two authentication servers 602 for fault tolerance, but can support many additional authentication servers 602 as load demands. FIG. 6 shows authentication servers 602 as standalone systems for clarity.
20 However, those skilled in the art will recognize that actual implementation may involve rack-mounted components with a shared keyboard and monitor.

Authentication servers 602 may use the Windows NT operating system and the cryptographic services available in
25 version 4.0 (SP3) and later. Authentication servers 602 are capable of software-based cryptographic services, but can be upgraded to hardware-based encryption technology as load demands. For devices that support multiple end users, such as Internet Telephony gateways 108 & 114, authentication servers 602 may also be

configured to support end-user level authentication. End-user identification and authentication (such as calling card and PIN numbers) may be included with each service request. Although optional, the end-user identification allows a service point 112
5 provide several enhanced services to its customers. Enhanced services may include sophisticated fraud control, end-user billing, and roaming services.

Once a service point 112 has authenticated a device (gateway), it can provide routing services for that device. In the
10 exemplary operating environment, routing services may rely on special purpose routing engines 110, which will be described in detail below. Since routing information is often sensitive data, routing engines 110 within a service point 112 are protected by an additional firewall 610. As with authentication servers 602, an
15 exemplary service point 112 includes multiple routing engines 110 for scalability and fault tolerance. FIG. 6 shows how routing engines 110 connect to the service point 112 infrastructure. Again, routing engines shown as standalone systems for clarity may typically be implemented as rack-mounted components. Routing
20 engines 110 preferably run routing software on high-performance UNIX servers. In the exemplary operating environment, each routing engine 110 operates autonomously, independent of other routing engines 110 in the service point 112.

FIG. 7 illustrates the overall message flow within a
25 service point 112. At step 701, an incoming authorization request message is filtered by the screening firewall 604 and passed to the web redirector 606. At step 702, the web redirector passes the message to an available authentication server 602. As shown in step 703, once an authentication server 602 validates a request, it

passes the request through the main firewall **610** to a routing engine **110**. The routing engine **110** processes the request and returns a response to an authentication server **602** at step **704**. Routing engines **110** also accept detail reports from authentication
5 servers **602**. Routing engines **110** forward transaction details, including the digitally-signed requests and detail reports to the database **120**, which may later be accessed by the billing and settlement system **124**. Most service points **112** use a virtual private network (VPN) link through the main firewall **610** for
10 communication to the database **120**.

Once a routing engine **110** returns route information, the authentication server **602** adds authorization information to the response before returning it to the requesting device (gateway). Step **705**, in which the authentication server **602** responds to the
15 requesting device, is the point at which authorization is added. When the routing engine **110** returns multiple eligible devices that can terminate the request, separate authorization information is created for each eligible device. This is true whether the devices are to be used simultaneously (such as in a multi-point conference)
20 or serially (in case the first choice is unavailable, for example). The originating device (source gateway **108**) must present the appropriate authorization information to a terminating device (destination gateway **114**) during call setup.

Authorization information consists of several pieces of
25 information subjected to appropriate cryptographic transformations. The exact information depends on the particular service, but, in general, comprises: (1) sufficient information to uniquely identify the call, which may include the called and calling numbers, network addresses of the originating and terminating

devices, unique identifiers such as call reference values and so on; (2) the transaction identifier, modified as necessary for terminating devices (for point-to-point services, for example, transaction IDs for terminating devices are changed from even to odd and their Hamming code is regenerated). Since terminating devices must include a transaction ID in detail reports, including a transaction ID in the authorization information forces the terminating device to examine that information and increases the likelihood that it will thoroughly check the information; (3) a valid time and an expiration time which limit the duration of call setup to help prevent inappropriate re-use of authorization information; and (4) a random value to be combined with the valid and expiration times for eliminating the probability of inappropriate reuse of authorization information. Terminating devices, upon accepting a call, are required to store this random number until the expiration time has passed. After the expiration time has passed, a terminating device must reject any setup request that includes the same random number. Authorization information may also include a maximum call duration, which limits the duration of calls that a device is willing to authorize. Authorization information may be encrypted using the public key of the terminating device and may be digitally signed by the service point 112. The encryption prevents originating devices from modifying its contents, and the digital signature lets the terminating device verify that the information did come from the service point 112.

The quality of the ultimate communication between originating and terminating devices is important. Round trip delay, for example, is a critical factor in the quality of voice phone calls. The service point operator 125 is able to estimate the

communications quality to different terminating devices and use those estimates to rate each possible route. Some of the models used to estimate quality depend heavily on the specific service. Audio codecs, for example, may have a significant effect on voice quality. Some quality measures, however, apply generally to many services accessed over the Internet 102. Those skilled in art will recognize that service quality monitoring may be accomplished by a separate system (not shown) connected to the Internet 102 and maintained by the service point operator 125. Additionally, the mechanisms for performing service quality monitoring may be incorporated into a service point 112, or any other system maintained by the service point operator 125. Also, a source gateway 108 or a destination gateway 114 may independently perform the tasks of service quality monitoring. A service point operator 125 may provide service quality monitoring software to assist the source and/or destination gateway operator.

One measure of quality between two devices is the length of the network path between them. The length of the network path can be modeled by calculating the number of autonomous systems (AS) in the path between the two devices. To obtain the information needed to perform this calculation, software may be developed to establish Border Gateway Protocol (BGP4) peering relationships with BGP neighbors in other autonomous systems. From these peering sessions, a path may be determined, defined in terms of autonomous systems, from any peered AS to any other AS. To calculate exact paths, a service point operator 125 must peer with every transit AS that is a neighbor of an AS containing customer of the service point operator 125. It is not necessary to peer with the customer's autonomous systems

directly. In the absence of complete AS connectivity, the service point operator may estimate the distance between AS from partial information.

In some cases the difference in router hops between an
5 originating device and multiple potential terminating devices may be estimated. To do so, a service point operator may use the "traceroute" command to calculate hop counts from a service point 112 or other central point to each device (gateway). Though this information does not provide an absolute hop count between
10 the originating gateway 108 and terminating gateways 114, the relative difference may be used to estimate the relative difference the originating gateway 108 would experience.

In a manner similar to relative hop counts, a service point operator 125 can also estimate relative differences in round
15 trip delay. Instead of "traceroute," the service point operator may use UDP echo probes to measure round trip delays from a service point 112 or other central location. The difference in delays between two potential destination gateways 114 serves as an estimate of the delay difference an source gateway 108 would
20 experience between the same two destination gateways 114.

Another approach that a service point operator 125 may use to model expected service quality is extrapolation from historical data. Along with billing information, a service point operator 125 may collect quality measurements as part of detail
25 reports. Traditional statistical techniques adapted for the Internet environment can then be used to project future service quality.

In an exemplary embodiment, the service point operator 125 may maintain a system for monitoring the service quality to all gateways participating in the service. The service

point operator **125** may allow gateway operators to specify a premium they are willing to pay for improved service quality. The service point provider **125** may then program the service point **112** to route calls to gateways offering improved quality, as long as the rates charged fall within the originators' willingness to pay. If gateway operators are willing to make investments to improve their service quality, this approach lets them recover the cost of those investments through higher rates. Note that the service point operator **125** itself will likely not set rates or service quality standards. The concept of the service point **112** is to provide a market-based service that allows gateway operators the flexibility to set their own rates and establish their own service quality strictly according to market requirements.

The service point operator **125** may rely on two key parameters to determine Internet service quality: (1) delay and (2) packet loss. Although other factors can have a significant influence on users' perceptions of quality, these two parameters represent the most direct measures of the Internet's contribution to quality.

Round trip delay between the service point **112** and each gateway may be measured. The delay may be recorded in milliseconds with an accuracy of approximately 5 milliseconds. At each measurement, the paths used for the request and response messages are the normal forwarding paths employed by routers between the service point **112** and the gateways. Bi-directional packet loss between the service point **112** and each gateway may also be measured. Loss may be recorded as a percentage, where, for example, a measurement of 10% indicates that 1 out of 10 packets transmitted did not reach its destination.

In collecting the data for delay and packet loss, the service point operator **125** simulates the environment of an H.323-compliant voice call as closely as possible. The collection techniques are also structured to maximize the statistical relevance of the measurements. To probe both delay and loss, the service point operator **125** may send echo messages to the gateways and measures the resulting responses. To more closely simulate voice traffic, UDP echo messages with 256 octets of user data may be used. These messages may be directed to UDP port 7 on the destination gateway. If no responses are returned, the service point operator **125** may assume that UDP echo service is not available on the gateway in question, and it may retry the measurement using ICMP Echo Requests (pings), also with 256 octets of user data.

Since ICMP messages are often subject to special processing in routers and hosts, ICMP measurements are likely to indicate greater delay than UDP messages. For this reason, the service point operator **125** may encourage all gateway operators to enable UDP echo service on their gateways. The service point operator **125** may choose to make no adjustments to measurements obtained via ICMP Echo exchanges, but rather may compare them directly to other measurements made through UDP.

For each measurement block, the service point operator generates a steady stream of UDP or ICMP traffic at an exemplary rate of 3 packets per second. This stream roughly simulates the talk interval of a G.723A codec commonly used for H.323-compliant gateways. Each block may be measured for bi-directional packet loss and average round-trip delay. Both to avoid self-synchronization effects, and to minimize statistical bias, delay and loss measurements may be made according to a Poisson

distribution. Both the interval between measurement blocks and the length of each block are random values that follow an exponential distribution. Adjustment may be made to the mean of these distributions to obtain the best balance between network loading and measurement reliability. Those skilled in the art will appreciate that the practice of conducting measurements at exponential intervals, is not meant to imply that voice traffic (or, indeed, any Internet traffic) may be modeled by a Poisson process. The choice of exponentially distributed intervals is intended purely to minimize time bias in the measurements, not to mimic traffic patterns.

To calculate a single number for delay and loss for each gateway, straightforward statistical processing may be used. In particular, measurements may be retained for one week, and a percentile ranking within the retained values may be relied upon. The retained data set may be updated (by discarding old data and adding new measurements) each day at 0:00 hours UTC. When a gateway first joins the service, no service quality measurements will be available until 0:00 UTC on its second day of operation. Until a full week has passed, the service point operator 125 will rely on the available data for quality determination. As a single, representative value for both delay and loss, the service point operator 125 may use the 80th percentile for each measurement, over the most recent one week interval.

At the billing and settlement system 124, a service point operator 125 provides net settlement and billing services for its customers. The billing and settlement system 124 may be located at central and secured facilities. Service points 112 periodically update the billing and settlement system 124 with

detail reports received from devices (gateways). The billing and settlement system reconciles the different reports from each device involved in a single communications transaction and calculates the net settlement funds to be paid to or collected from each customer.

- 5 The service point operator **125** may execute the actual monetary transactions through traditional financial networks **126** at various financial institutions **128**.

Exemplary Routing Engine

As described above, a service point **112** in the
10 exemplary operating environment includes a routing engine **110** that is responsible for providing routing information to a source gateway **108**. The exemplary routing engine **110** is particularly useful in situations where a source gateway **108** is provided with the identity of the called party **118** (i.e. the called telephone
15 number), but is not provided with the address of an appropriate destination gateway **114**. Use of the exemplary routing engine **110** is even more appropriate in situations where there are more than one eligible destinations gateway **114a-c**. The exemplary routing engine **110** has the ability to determine the network addresses of all
20 eligible destination gateways **114a-c** and then prioritize the eligible destination gateways **114a-c**. As mentioned, the exemplary routing engine **110** provides the prioritized list of destination gateways **114a-c** to the source gateway **108**. The source gateway **108** then attempts to setup a call with the first-listed destination gateway
25 **114**. If the first-listed destination gateway **114** does not accept the call, for any reason, the originating gateway **108** attempts to setup a call with the next-listed destination gateway **114**. The source gateway continues to attempt to setup the call with each successive next-listed destination gateway **114** until the call is established.

Prioritization of eligible destination gateways **114** by the exemplary routing engine **110** is based on (1) preferences established by a source gateway operator **109**, (2) monetary value charged by a destination gateway operator **115** for access to a destination gateway **114** and (3) network environment conditions. The exemplary routing engine **110** provides maximum flexibility in routing choices by allowing source gateways operators **109** to set their own preferences and destination gateways operators **115** to set their own costs. Network environment conditions may be evaluated for the routing engine by a separate system, as described above in connection with service quality monitoring. Preferences, costs and network environment conditions are stored in a database **120** and this information is periodically accessed by the routing engine **110**.

A source gateway operator **109** may upload information to the database **120** via a web-site **122**, or via any other electronic transfer means. The web site **122** may be accessed via any commonly known web browser. The web site **122** may contain a form to be populated by the source gateway operator **109**. Those skilled in the art will recognize that no particular user interface (UI) for the web site **122** is required, however, the UI should be as user friendly as possible.

The preferences defined by the source gateway operator **109** relate to monetary cost, delay and reliability. The routing engine **110** uses the preferences set by the source gateway operator **109** as filters for eliminating potential destination gateways and determining determine the best destination gateway to terminate a called number. The source gateway operator **109** may specify none or any combination of preferences as its filters. Also, service point operator

125 and source gateway operator **109** may specify the maximum number of call routes that will be returned in response to each call authorization request. The routing engine **110** may be programmed to respond with whichever maximum number is less.

5 In the exemplary embodiment, a first preference is defined as “the maximum amount the source gateway operator **109** is willing to pay for a call to a specific dial string.” All destination gateways charging rates that are greater than the maximum price are eliminated from the search for the optimal call route. The maximum
10 price criteria may be specified as a function of time of day and day of the week. This maximum amount may be expressed in any type of currency and any fraction thereof.

 Another preference in the exemplary embodiment may be defined as “the maximum delay a source gateway operator **109** is
15 willing to tolerate.” The maximum delay is preferably the overall network delay, which is measured by the time taken for a signal to travel between the calling party **104** and the called party **118**. The lower the network delay from when the calling party **104** speaks to when the called party **118** hears the words, the higher the quality of
20 the conversation. Those skilled in the art will appreciate that there are many other factors that determine delay or latency in a voice telephone call. Other examples of delay include: delay due to interlocking of a digital conversation, buffering delays inside gateways, delays on public switched telephone networks (PSTN),
25 etc. It is contemplated that the such other sources of delay may be factored into the “maximum delay preference.” However, it is expected that network delay will be the most significant contributor to the overall quality of an Internet telephony call. Thus, in the exemplary embodiment, other sources of delay are ignored.

Another preference defined in the exemplary embodiment is the "maximum autonomous system (AS) hop count that the source gateway operator will tolerate." The Internet 102 comprises a collection of "autonomous" IP networks. Thus, a
5 voice signal traveling from a source gateway 108 to a destination gateway 114 may traverse one or more autonomous systems. The fewer autonomous systems that a signal must traverse, the lower the network delay should be. While it is not necessarily true that a lower AS hop count will lead to lower delay, AS hop count does
10 provide a good estimation of network delay. Furthermore, a lower AS hop count tends to suggest that there will be less signal loss (packet loss) when the voice signal reaches its destination.

A determination of AS hop count is instantaneous and may be derived from information relating to the dynamic topology
15 of the Internet 102, which is dictated by congestion, etc., that is continuously gathered and stored in the database 120. To the contrary, network delay may only be determined by actual measurement, as described above, which involves significantly more time than an AS hop count calculation. Therefore, a source
20 gateway operator 109 may elect to use the AS hop count preference, rather than the "maximum delay" preference.

An additional preference may be defined as "autonomous system (AS) matching," which dictates that, whenever possible, a route should be chosen such that both the
25 source gateway 108 and the destination gateway 114 are on the same AS. A determination of AS matching is similar to a determination of AS hop count. A determination of AS matching dictates that given the choice of an AS hop count of zero and any other AS hop count, the route having the AS hop count of zero will

be chosen. Similarly, "domain matching" and "platform matching" preferences may be defined, such that no destination gateway 114 that operates in a specified domain or on a specified platform will be selected to terminate a call.

5 Of course, a source gateway operator 109 may set as many or as few preferences as it would like. It is contemplated that preferences other than the exemplary preferences described herein may be implemented. For example, the source gateway operator 109 may also set preferences defining that all destination gateways
10 114 that are not interoperable with the source gateway 108 or do not offer the requested type of service, i.e. voice or fax, are to be eliminated from consideration. Other preferences may include, but are not limited to: "historical availability," which eliminates from
15 consideration all destination gateways 114 that have historical availability less than the required availability specified by the source gateway operator 109; "preferred operator," which eliminates from consideration all destination gateways 114 that are not operated by a preferred operator specified by the source gateway operator 109; "packet loss," which eliminates from
20 consideration all destination gateways 114 whose historical packet loss is greater than the minimum specified by the source gateway operator 109; "latency," which eliminates from consideration all destination gateways 114 whose historical packet loss is greater than the maximum latency specified by the source gateway operator 109; "quality of service (QoS) score," which eliminates
25 from consideration all destination gateways 114 whose QoS is less than the minimum specified by the source gateway operator 109; "RSVP preference," which eliminates from consideration all destination gateways 114 that cannot support, or are on networks

that do not support, bandwidth reservation; and “best worst case,” which eliminates from consideration all destination gateways **114** whose best worst case scenario for packet loss and latency exceeds the minimum best worst case scenario specified by the source gateway operator **109**. The best worst case is estimated by summing the packet loss or latency between the source gateway **109** and a reference point maintained by the service point operator **125** (SP_{ref}) plus the latency and packet loss between the destination gateway **114** and SP_{ref} . For example, the worst case for packet latency between a source gateway **109** and a destination gateway **114** is assumed to be equal to packet latency between the source gateway **109** and SP_{ref} + destination gateway and SP_{ref} .

Preferences may also be ranked by the source gateway operator **109**, such that one type of preference is given more weight by the routing engine **110** when eligible destination gateways are prioritized. A predetermined system for ranking preferences is useful when the routing engine **110** locates more than one destination gateway **114** that satisfies all preferences. Thus, a ranking system may be used as a “tie breaker.” A source gateway operator **109** may prioritize its preferences in any order, or no order at all.

Preferences may be ranked by least cost. By way of example, a preference designated by a source gateway operator **109** may dictate that the maximum price the source gateway operator **109** is willing to pay for a call to London is \$.40/minute. The routing engine **110** may locate two eligible destination gateways **114a-b** to terminate the call; one destination gateway **114a** charging \$.35/minute and the other destination gateway **114b**

charging \$.30/minute. Both destination gateways **114a-b** are eligible because they each meet the preference designated by the source gateway operator **109**. However, the source gateway operator **109** may also specify that all eligible destination gateways
5 **114a-b** are to be ranked (or sorted) by least cost. Thus, the destination gateway **114b** charging \$.30/minute will be assigned a higher priority than the destination gateway **114a** charging \$.35/minute.

Preferences may also be ranked by AS matching, such
10 that priority is given to routes involving gateways on the same autonomous system. Also, preferences may be ranked by subscriber (intra-domain) matching, such that priority is given to routes involving destination gateways **114** connected to the same network as the source gateway **109**. Intra-domain routing may be predefined
15 to take first priority even if price and quality of service are inferior to other gateways.

Preferred platform matching allows a source gateway operator **109** to prioritize its preferred destination gateway platform for termination. For example, Lucent and VocalTec gateways may
20 be interoperable; however, a source gateway operator **109** who has deployed Lucent gateways might prioritize that calls be routed to Lucent gateways as a first choice. Or the source gateway operator **109** might specify that VocalTec gateways be eliminated as a possible destination gateways, even though they are compatible and
25 are the best match for the source gateway operator's **109** other routing criteria.

Preferences may also be ranked based on minimum AS hop count. Priority may be given to BGP query route calls to destination gateways **114** that can be reached with the fewest

autonomous system hops . Preferences may also be ranked based on historical records of availability (as a function of day of week and time of day). Priority may thus be given to destination gateways **114** with the best historical availability or eliminate those gateways with
5 historical availability less than the minimum required by the source gateway operator **109**. Further, to support implementation of bilateral agreements, a service point operator **125** may allow source gateway operators **109** to prioritize their preferred destination gateway operators **115** for termination. For example, source
10 gateway **109** may specify that destination gateway operator **115b** is always its first choice for termination and destination gateway operator **115c** is its second choice for termination even if other terminating gateways are a better fit for the source gateways operator's **109** routing criteria. Similarly, a source gateway operator
15 **109** may prioritize specific individual destination gateways as its preferred termination point for a call to a dialed number string.

Based on historical records of packet loss between the source gateway **109** and potential destination gateways **114** (possibly as a function of day of week and time of day), priority may be
20 assigned based on lowest historical packet loss. In a similar manner, priority of routing may be assigned based on the lowest historical packet latency between the source gateway **109** and potential destination gateways **114** (possibly as a function of day of week and time of day). Further, ranking of potential destination gateways **114**
25 may be based on other preference, such as: QoS scoring, by using historical data of packet loss, latency and availability with codec and gateway implementation choices to make best destination gateway **114** selection; RSVP, by routing calls based on which call path offers the required bandwidth reservation at the lowest price; and

“best worst case,” by routing calls based on the best worst case scenario described above. In the absence of any ranking or sorting scheme specified by a source gateway operator **109**, the routing engine **110** may either employ its own ranking scheme, or in the interest of impartiality, randomly prioritize the eligible destination gateways **114**.

When setting preferences, the source gateway operator **109** may also provide the routing engine **110** with “preference criteria,” which define the circumstances in which a given preference or set of preferences are to apply. For example, the source gateway operator **109** may specify a called number prefix to which a certain preference is to apply. Accordingly, all calls placed to the specified called number prefix are to be routed based upon the corresponding preferences. In the exemplary embodiment, a called number prefix is defined by ITU standard E.164. An exemplary called number may be “+ 1 404 567 8910.” According to E.164, the components of the exemplary called number may be defined as follows: “+” designates an international call; “1” is the country code for the United States; “404” is the national destination code, also known as the area code in the United States; “567” is the local exchange; and “8910” is the identifier of the actual telephone line.

The source gateway operator **109** may designate any portion of the called number as the called number prefix. By way of illustration, the called number prefix “+1” signifies that a certain preference is to be applied to all calls to/from the United States. A called number prefix of “+1404” signifies that a certain preference is to be applied to all calls to/from Atlanta. Similarly, if it is known that corporation X utilizes all telephone numbers between

+1.404.567.8910 and +1.404.567.8919, the called number prefix may be designated as +1404567891, which will cause a certain preference to be applied to all calls to/from corporation X. As can be seen, the called number prefix may comprise any portion of the
5 called number and is not limited to any particular division thereof.

In addition to called number prefixes, a preference criteria may include the identity of a specific source gateway **108**. As mentioned previously, a source gateway operator **109** may own and/or operator many source gateways **108**. The source gateway
10 operator **109** may desire that different preferences apply to calls handled by different source gateways **108**. Other preference criteria may include specifications of the time of day and/or the day of the week. A time of day preference criteria may be specified down to the second (or any fraction thereof), if desired. An effective date
15 may also be specified as a preference criteria. An effective date allows a source gateway operator **109** to specify that certain preferences are to be considered for routing from a given point in time.

Routing decisions made by exemplary routing engine
20 **110** are also based on preferences set by destination gateway operators **115**. In the exemplary embodiment, destination gateways operators **115** set only one preference. The preference set by a destination gateway operator **115** is the monetary charge for access to a destination gateway **114**. A destination gateway
25 operator **115** is typically not concerned with delay, packet loss, or other factors that may be of concern to source gateway operator **109**. Once a network packet containing a voice signal arrives at a destination gateway **114**, the packet is routed to the appropriate called party **118**, regardless of the amount of delay or packet loss

associated therewith. Like the originating gateway operator **109**, the destination gateway operator **115** may designate certain preference criteria. Such preference criteria allow the destination gateway operator **115** to define the circumstances in which its preferences, i.e., cost schedule, will apply. Preference criteria may relate to a specific destination gateway **114**, a called number prefix, a time of day, a day of the week, an effective date, etc.

All preferences and preference criteria set by the source gateway operator **109** and the destination gateway operators **114** are stored in the database **120**. Fig. 8 illustrates an exemplary database table **801** for storing information relating to a source gateway **108**. In an exemplary embodiment, database tables **801** may be sorted first by gateway identification number **802** and then by called number prefix **804**, effective date **806** (in descending order), start day **808** and start hour **810**. Sorting data in the described manner is not required, but is recommended for improved performance. A routing engine **110** may be required to process a significant amount of routing requests in a short period of time. Thus, the database table **801** should be organized in an easily searchable manner. The ultimate goal of the routing engine **110** is to access the database table **801** to determine the preferences for a source gateway **108**, such as the maximum price **820** that the source gateway **108** is willing to pay for an Internet telephony call.

FIGS. 9A and 9B describe an exemplary method by which a routing engine **110** may access a database table **801** to locate the preferences for a source gateway **108**. At step **905**, a routing engine **110** receives an authorization request from a source gateway **108**, via an authentication server **602**. The authorization request includes the identification number **802** of the source

gateway 108. At step 910, the routing engine 110 accesses the database table 801 to locate the preferences corresponding to the source gateway identification number 802. First at step 915, a search of the appropriate database column is conducted to locate the source gateway identification number 802. A binary search is a quick and effective method of searching for the desired gateway identification number 802.

At step 920, an offset value 826 and a 'number of entries' value 824 are checked to determine the location of the first and last set of preferences for a given source gateway identification number 802. Many times, a source gateway operator 109 will designate multiple sets of preferences, each to be applied in circumstances defined by designated preference criteria. Therefore the database table 801 maintains an offset value 826 so that the routing engine is able to locate the first and last record for a given gateway identification number 802.

Once the first and last record for the desired gateway identification number 802 is located, a search is conducted at step 925 on all included entries to determine the longest called number prefix 804 corresponding to the gateway identification number 802. The size 816 of the longest called number prefix may be stored in the database table 801 for searching convenience. Again, a binary search is likely to be the most efficient way to search for the longest called number prefix. Once the longest called number prefix 804 is located, it is checked at step 930 to see if it matches the called number for the Internet telephony call, as supplied by the source gateway 108. If, at step 930, all digits in the longest called number prefix 804 are not found in the called number the called number prefix is not considered to match the called number. In

that case, the preferences corresponding to the longest called number prefix **804** will not apply to the call and the next longest called number prefix **804** is located at step **940**. The matching process is repeated until a matching called number prefix **804** is located.

When a matching called number prefix **804** is located, a determination is made at step **945** as to whether the source gateway **108** has a rate plan corresponding to the called number prefix. If no rate plan is found, the method returns to step **940** to locate the next-longest called number prefix **804**. If a rate plan is found, however, a determination at step **950** is made as to whether the called number is excluded from the rate plan. If the called number is excluded from the rate plan, the method again returns to step **940** to locate the next-longest called number prefix **804**.

If it is determined that the called number is not excluded from the rate plan, a determination is made at step **955** as to whether the source gateway **108** has received permission from the service point operator **125** to access the service point. Permission may be based on a finding that the source gateway operator **109** has secured sufficient funds. If permission has not been received by the source gateway **108**, the method exits at step **975**. Proceeding, a determination is next made at step **960** as to whether the rate plan of the source gateway **108** is effective. If the effective date of the rate plan is in the future, the preferences set by the source gateway **108** cannot yet be applied. Similarly, at step **965**, the start day, **808** start hour **810**, end day **812** and end hour **814** are checked to determine validity with respect to the current day and time. If the rate plan is not in effect or the time of day or day of week are not valid, the method returns to step **940** to locate

the next-longest called number prefix. When a record is encountered that satisfies all called number prefix **804** and date and time requirements, the corresponding price preference **820** is considered to apply to the call. This price preference is read at step **970** and the method terminates at step **980**. Those skilled in the art will recognize that the above described method may be used to locate other preferences of the source gateway **108**, such as a delay preference, an AS hop count preference and, but not limited to, any other preference mentioned above.

Once the preferences of the source gateway **108** are located, the routing engine **110** must locate an eligible destination gateway **114**. FIG. 10 shows that a database table **1001** for storing information relating to a destination gateway **114** may be sorted by terminating number prefix **1002** and then by destination gateway identification number **1004**. In this way, the database table **1001** may be conveniently searched by the "trie" method. It is anticipated that the database table **1001** will store up to several millions of entries. It has been determined that a trie method is the most efficient way to access the appropriate data. However, as will be appreciated by those of ordinary skill in the art, any data access method may be employed.

FIGS. 11A, 11B and 11C show an exemplary method that may be used by the routing engine **110** to locate eligible gateways in a database table **1001**. First, at step **1102**, the routing engine **110** accepts the called number from the source gateway **108**. Next, at step **1104**, the routing engine **110** searches for terminating number prefixes **1002** that match the called number, so as to locate a plurality of destination gateways **114** that may be able to terminate the call. As mentioned, an effective method for

locating matching terminating number prefixes **1002** in the database is a well-known trie function.

If no matching terminating number prefixes **1002** are located at step **1105**, the method ends at step **1150**. For each
5 matching terminating number prefix **1002** that is located, the corresponding destination gateway may be put through an set of initial "pre-screening" tests in order to determine if it is a potential destination gateway that is able to terminate the call. At step **1106**, a destination gateway is identified that corresponds to a matching
10 terminating number prefix **1002**. Then, at step **1107** a determination is made as to whether the destination gateway **114** is functionally able to terminate the call. For one reason or another, a given destination gateway **114** may be disconnected, disabled, or otherwise taken off-line. Such off-line destination gateways are
15 eliminated from consideration as potential destination gateways **114**. Thus, if the destination gateway **114** is not functionally able to terminate the call, the method proceeds to step **1224**, where a determination is made as to whether any other matching terminating number prefixes **1002** were found.

20 At step **1108** a determination is made as to whether the terminating gateway **114** has received permission from the service point operator **125** to conduct transactions with the routing engine. To reiterate, permission may be based on any subjective factors, including the amount of funding available to the
25 destination gateway **114**. If permission has not been granted by the service point operator **125** the method proceeds to step **1124**, where a determination is made as to whether any other matching terminating number prefixes **1002** were found.

If the destination gateway 114 has been granted permission, a determination is made at step 1110 as to whether the destination gateway 114 is interoperable (compatible) with the source gateway 108. If the destination gateway 114 is not
5 interoperable with the source gateway 108, the method proceeds to step 1124, where a determination is made as to whether any other matching terminating number prefixes 1002 were found.

If the destination gateway 114 is compatible with the source gateway 108, a determination is made at step 1112 as to
10 whether the destination gateway 114 has a rate plan in effect. Again, if no effective rate plan exists, a search is made for additional matching terminating number prefixes 1002 at step 1124. If an effective rate plan exists, a determination is made at step 1114 as to whether the requested type of service is supported. As
15 mentioned, the source gateway 108 may request various services such as voice, fax, data, etc. If the destination gateway 114 does not support the requested service, the method proceeds to step 1124 to search for another potential destination gateway 114.

However, if the destination gateway 114 does support
20 the requested service, a determination is made at step 1118 as to whether the rate plan specifies a termination price for the present time and date. Once again, if the termination price is not valid for the present time and date, the method proceeds to step 1124 to search for another matching terminating number prefix.
25 Otherwise, a determination is made at step 1120 as to whether the called number is excluded or "blocked" by the destination gateway 114. As an example, a destination gateway may be programmed to terminate all calls to the United States, except "1-976" calls. If the called number is excluded, the method moves to step 1124 to

search for another matching terminating number prefix. If the called number is not excluded, the destination gateway 114 has passed all of the "pre-screening" tests and is considered to be a potential destination gateway. The terminating number, address and other information relating to the potential destination gateway 114 is stored in a "first-pass" list at step 1122.

Next at step 1124, a determination is made as to whether any other matching terminating number prefixes 1002 were found. If so, the above described steps are repeated until all potential destination gateways 114 have been added to the first-pass list. Otherwise, the method proceeds to step 1130 where the first-pass list is sorted by destination gateway identification number 1004 and by the number of digits in the terminating number prefix 1002 (in descending order). Then, at step 1132, the entries for the first-listed potential destination gateway are searched to locate the longest terminating number prefix 1002 for that destination gateway that matches the called number.

At step 1134, a determination is made as to whether the potential destination gateway 114 is able to terminate the call to the longest matching terminating number prefix while satisfying the preferences set for the source gateway 108. If the potential destination gateway is able to terminate the call while satisfying the source gateway 108 preferences, the potential destination gateway 114 information is stored in a second-pass list of remaining potential destination gateways 114 at step 1138. Subsequently, at step 1140, a determination is made as to whether any other potential destination gateways are in the first-pass list. If so, the entries for the next potential destination gateway are searched to locate the longest terminating number prefix. The

method then returns to step **1134** and is repeated for every potential destination gateway in the first-pass list.

When complete, the second-pass list of remaining potential destination gateways **114** is sorted at step **1142** according to a pre-determined ranking system. As mentioned, the ranking system may be designated by the source gateway operator **109** and may be such that a certain weight is to be accorded to each source gateway preference. Alternately, the ranking system may be designated by the service point operator **125**. At step **1144** all potential destination gateways **114** having a duplicate rank are sorted in random order. Lastly, at step **1148**, a configurable number of the prioritized potential destination gateways **114** are returned to the source gateway **108**. The number of returned prioritized potential destination gateways may be specified by the source gateway operator **109** or by the service point operator **125**. The exemplary method terminates at step **1150**.

As shown in FIG. 12, the internal architecture of an exemplary routing engine **110** comprises several interrelated components. These components will be described in detail to provide a further understanding of how to implement the exemplary routing engine **110**. However, those skilled in the art should recognize that the architecture of FIG. 12 is provided by way of example only and is not intended to limit the scope of the invention to components shown.

A call router **1202** is the component that is actually responsible for receiving call authorization requests and returning a set of eligible terminating gateways to the authentication server. It is possible to run several call routers **1202** at the same time on a single routing engine **110**. A call router **1202** can be configured to

use one or more threads to process incoming transactions. Also, the call router 110 can be configured not to use threads at all, effectively acting as a single-threaded program.

In order to determine how to route a call, a call router
5 1202 needs information regarding the source gateway 108 and the destination gateway 114 such as pricing, exchange rates and other preferences. This information is stored in a central database 120 and is periodically transferred to a local database 1204 that resides on every routing engine 110. For performance reasons, the call
10 router 1202 does not access the local database 1204 directly. Instead, the call router 1202 uses a set of reference files 1208 that contain all information needed to route calls, but in a format that is much faster to access than a database table. The reference files are created periodically by the reference file extractor 1210. The
15 reference file extractor is also responsible for notifying all call routers 1202 when a new set of reference files 1208 is created. In addition, all call routers 1202 periodically (a few times per hour) check for the existence of a new set of reference files 1208, just in case a message from the reference file extractor 1210 is lost. There
20 is no requirement for all call routers 1202 to switch to a new set of reference files 1208 at exactly the same time, due to the fact that all information contains effective dates, which must be at least twenty-four hours in the future.

Each call router 1202 memory-maps the reference
25 files 1208 in read-only, shared mode. This means that all processes and threads using the same set of reference files 1208 will effectively share memory. Thus, if a total of ten call routers 1202 are accessing a set of reference files 1208 occupying 60MB, the total memory usage will be 60MB and not 10*60MB.

As mentioned, the reference file extractor **1210** is responsible for creating reference files **1208** used by the call router **1202** to decide how to route calls. The reference file extractor **1210** extracts information from the local database **1204** and creates
5 a set of four files: a first file relating to originating gateways, their pricing criteria, numbers, etc.; a second and third file relating to terminating gateways, their pricing criteria, numbers, etc.; and a fourth file relating to exchange rates. Either the whole set of reference files **1208** is successfully created or not at all. The base
10 file name is the same for every file in a set, the file extensions are different. A unique base file name is generated for every set. Once a set of reference files **1208** is created, the file extractor **1210** notifies all call routers **1202** that new files are present.

All references between data entities within each
15 reference file **1208** as well as across files are expressed as record numbers relative the beginning of the file being referenced. That means the same set of reference file **1208** can be used at the same time by different processed in read-only mode.

In one implementation, the file extractor **1210** may
20 completely re-create all reference files **1208** every time it runs; (e.g. once/hour), provided that data in the tables has changed since the last execution. It take at most thirty seconds (on Ultra2) to completely re-create all information for 5000 destination and source called numbers (total 10000 numbers); that includes the
25 time required to retrieve the data from the local database **1204**. All sorting, etc. is done by the file extractor **1210** itself, not by the local database **1204**.

Another implementation of the file extractor may create incremental reference file sets **1208** to be merged with

previous sets, so as to create new versions. Alternately, the file extractor 1210 may construct an index for accessing every reference file 1208 or store the data as linked lists to allow for very frequent insertions and deletions without having to physically sort any data.

The file extractor 1210 is also responsible for near-real time deactivation of gateways. When instructed to do so, the file extractor 1210 may update relevant reference files 1208 in each set to indicate that a gateway has been deactivated. The file extractor 1210 updates reference files 1208 by memory mapping the reference files 1208 in shared, writeable mode, looking up entries belonging to the gateway to be deactivated and modifying the entries. When finished, the file extractor makes the changes visible to other programs, e.g. to the call router 1202. The process of deactivating gateways may be executed concurrently with the execution of call routers 1202 and does not require any explicit synchronization between such components.

20

AMENDED SHEET

CLAIMS

We claim:

5

1. A method for determining a preferred route for a call that is to be routed over an IP network including a source gateway (103) and destination gateways (114a, b, c)

CHARACTERIZED BY:

10

accepting from a source gateway operator (109) a preference corresponding to the source gateway (105);

accepting a called number from the source gateway (105);

15 identifying a plurality of potential destination gateways (114a, b, c) that are capable of terminating the called number;

filtering the potential destination gateways based on the preference from the source gateway (105), so as to yield one or more remaining destination gateways;

20

prioritizing the remaining destination gateways according to a predetermined ranking system;

supplying the addresses of the prioritized remaining destination gateways to the source gateway.

AMENDED SHEET

2. The method of claim 1, wherein the source gateway (105) successively attempts to establish the call with each
5 prioritized remaining destination gateway until the call is established.

3. The method of claim 1, wherein the source gateway operator (109) also sets a preference criteria that indicates
10 the circumstances in which the preference is to be applied.

4. The method of claim 1, wherein the preference relates to the maximum price that the source gateway (105) is willing to pay for the call.

15

5. The method of claim 4, wherein the plurality of potential destination gateways (114a, b, c) each supply a rate plan; and

20 wherein filtering the potential destination gateways (114a, b, c) comprises eliminating all potential destination gateways charging a rate that is greater than the maximum price that the source gateway (105) is willing to pay.

AMENDED SHEET



6. The method of claim 5, wherein prioritizing the plurality of remaining destination gateways (114a, b, c) comprises ranking the plurality of remaining destination gateways from the lowest rate charged for terminating the call to the highest rate charged for terminating the call.
7. The method of claim 6, wherein the plurality of remaining destination gateways are further ranked according to autonomous system matching.
8. The method of claim 1, wherein the preference relates to a determination of autonomous system matching.
9. The method of claim 1, wherein the preference relates to a determination of domain matching.
10. The method of claim 1, wherein the preference relates to a determination of specified platform system matching, the platform being specified by the source gateway operator (109).
11. The method of claim 1, wherein the preference relates to a maximum autonomous system hop count.

AMENDED SHEET

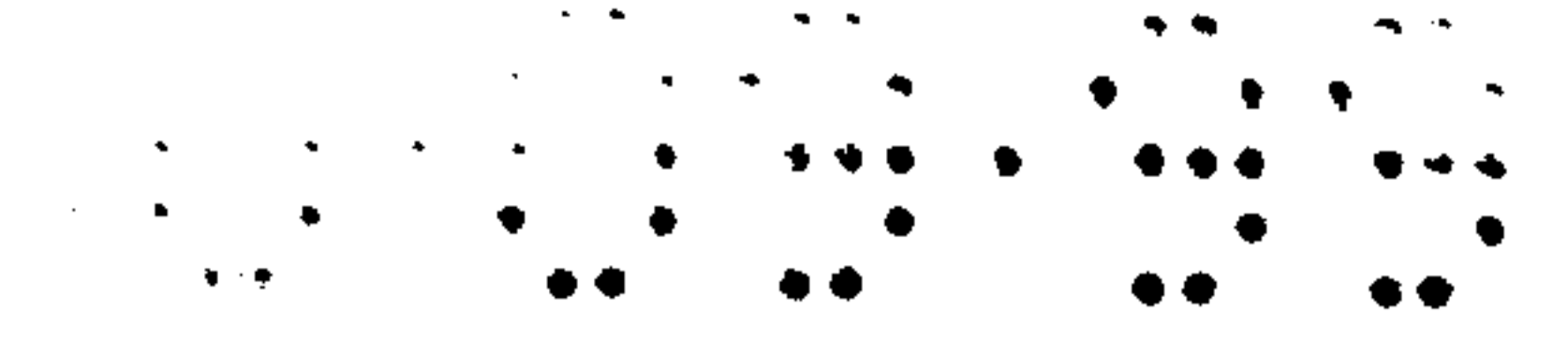

12. The method of claim 1, wherein a plurality of preferences and a plurality of preference criteria are accepted from
5 the source gateway operator (109); and

wherein a determination is made from the preference criteria as to which of the preferences apply to the source gateway (105) initiating the call.

10 13. The method of claim 1, wherein identifying the plurality of potential destination gateways (114a, b, c) comprises identifying a plurality of destination gateways (114a, b, c) that are able to terminate any portion of the called number.

15 14. The method of claim 13, further comprising the step of eliminating from consideration each of the destination gateways (114a, b, c) that do not have a rate plan in effect for the time and date of the call.

20 15. The method of claim 13, further comprising the step of eliminating from consideration each of the destination gateways (114a, b, c) that do not support the service requested by the source gateway (105).

AMENDED SHEET



16. The method of claim 13, further comprising the step of eliminating from consideration each of the destination gateways (114a, b, c) that do not interoperate with the source gateway (105).

17. The method of claim 13, further comprising the step of eliminating from consideration each of the destination gateways (114a, b, c) that have not been granted permission to terminate the call.

18. The method of claim 1, further comprising the step of randomizing any of the prioritized remaining destination gateways that have a duplicate priority.

19. The method of claim 1, wherein the source gateway operator (109) designates the number of the addresses of the prioritized remaining destination gateways to be supplied to the source gateway.

20. The method of claim 1, wherein the call comprises a voice over IP call.

21. The method of claim 1, wherein the call comprises a video over IP call.

AMENDED SHEET

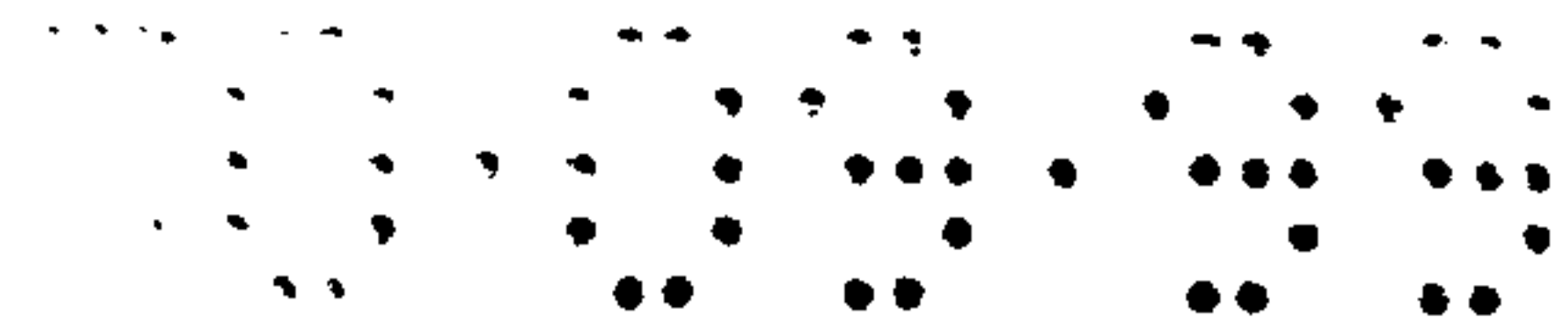

22. The method of claim 1, wherein the call comprises a fax over IP call.

5

23. A routing engine (110) for assisting a source gateway in determining a preferred route for a call that is to be routed over an IP network including the source gateway (105) and destination gateways (114a, b, c), CHARACTERIZED BY comprising:

10

a database (20) for storing a set of source gateway preferences and a set of destination gateway preferences; and

a call router (1202) operable to:

15

accept a called number from the source gateway (105), identify a plurality of potential destination gateways that are capable of terminating the call to the called number,

20

filter the potential destination gateways based on the source gateway preferences and the destination gateway preferences,

prioritize the remaining destination gateways based on a predetermined ranking system set by a source gateway operator, and

25

supply the addresses of the prioritized remaining destination gateways to the source gateway.

AMENDED SHEET

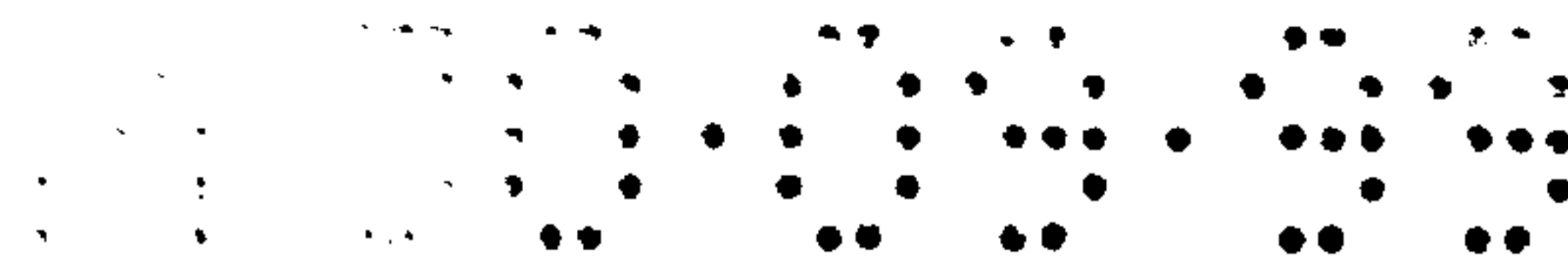

24. The routing engine of claim 23 comprising a plurality of call routers (1202).

5

25. The routing engine of claim 23, wherein the source gateway (105) and the destination gateway (114a, b, c) are operated independently of each other.

10

26. The routing engine of claim 23, wherein the set of source gateway preferences are supplied by a source gateway operator (109) via a web-site (122) and are downloaded into the database (120).

15

27. The routing engine of claim 23, wherein the set of destination gateway preferences are supplied by a destination gateway operator (115) via a web-site and are downloaded into the database.

20

28. The routing engine of claim 23, wherein the source gateway preferences relate to the maximum cost that the source gateway (105) is willing to pay for the call.

AMENDED SHEET

29. The routing engine of claim 23, wherein the destination gateway preferences relate to the rate that the destination gateway (114a, b, c) will charge for the service of terminating the call.

30. The routing engine of claim 23, wherein the call comprises a voice over IP call.

31. The routing engine of claim 23, wherein the call comprises a video over IP call.

32. The routing engine of claim 23, wherein the call comprises a fax over IP call.

33. A method for routing a call over an IP network including a source gateway and destination gateways, CHARACTERIZED BY:

supplying a source gateway preference and a called number to a third-party routing engine (110), the routing engine operable to:

locate a plurality of potential destination gateways (114a, b, c) for terminating the call,

filter the potential destination gateways (114a, b, c) based on the source gateway preference, so as to yield a set of remaining potential destination gateways, and

AMENDED SHEET

prioritize the remaining potential destination gateways;

5 receiving from the routing engine (110) a list of the prioritized remaining potential destination gateways; and

in order of descending priority, successively attempting to route the call to each of the listed remaining potential destination gateways until the call is established.

10

34. The method of claim 33, wherein the source gateway preference relates to the maximum cost that the source gateway (105) is willing to pay for the call.

15

35. The method of claim 33, wherein the source gateway preference relates to a determination of autonomous system matching.

20

36. The method of claim 33, wherein the source gateway preference relates to a determination of domain matching.

37. The method of claim 33, wherein the source gateway preference relates to a determination of specified platform matching.

AMENDED SHEET

58a

38. The method of claim 33, wherein the source gateway preference relates to a maximum number of autonomous system hops that the source gateway (105) will tolerate for the call.

39. The method of claim 33, wherein the source gateway preference relates to a determination of historical availability of the potential destination gateways (114a, b, c).

40. The method of claim 33, wherein the source gateway preference relates to a preferred destination gateway operator.

41. The method of claim 33, wherein the source gateway preference relates to a preferred destination gateway.

42. The method of claim 33, wherein the source gateway preference relates to a maximum amount of packet loss that will be tolerated by the source gateway (105) during the call.

43. The method of claim 33, wherein the source gateway preference relates to a maximum amount of latency at will be tolerated by the source gateway (105) during the call.

AMENDED SHEET

44. The method of claim 33, further comprising the step of supplying a pre-determined ranking system to the routing engine (110), the ranking system to be used by the routing engine (110) in prioritizing the remaining potential destination gateways.

45. The method of claim 44, wherein a plurality of source gateway preferences are supplied to the routing engine (110); and

wherein the ranking system specifies the weight that is to be accorded to each source gateway preference when prioritizing the remaining potential destination gateways.

46. The method of claim 45, wherein the ranking system specifies that a highest priority is to be assigned to a least cost source gateway preference.

47. The method of claim 33, wherein the call comprises a voice over IP call.

48. The method of claim 33 wherein the call comprises a video over IP call.

49. The method of claim 33, wherein the call comprises a fax over IP call.

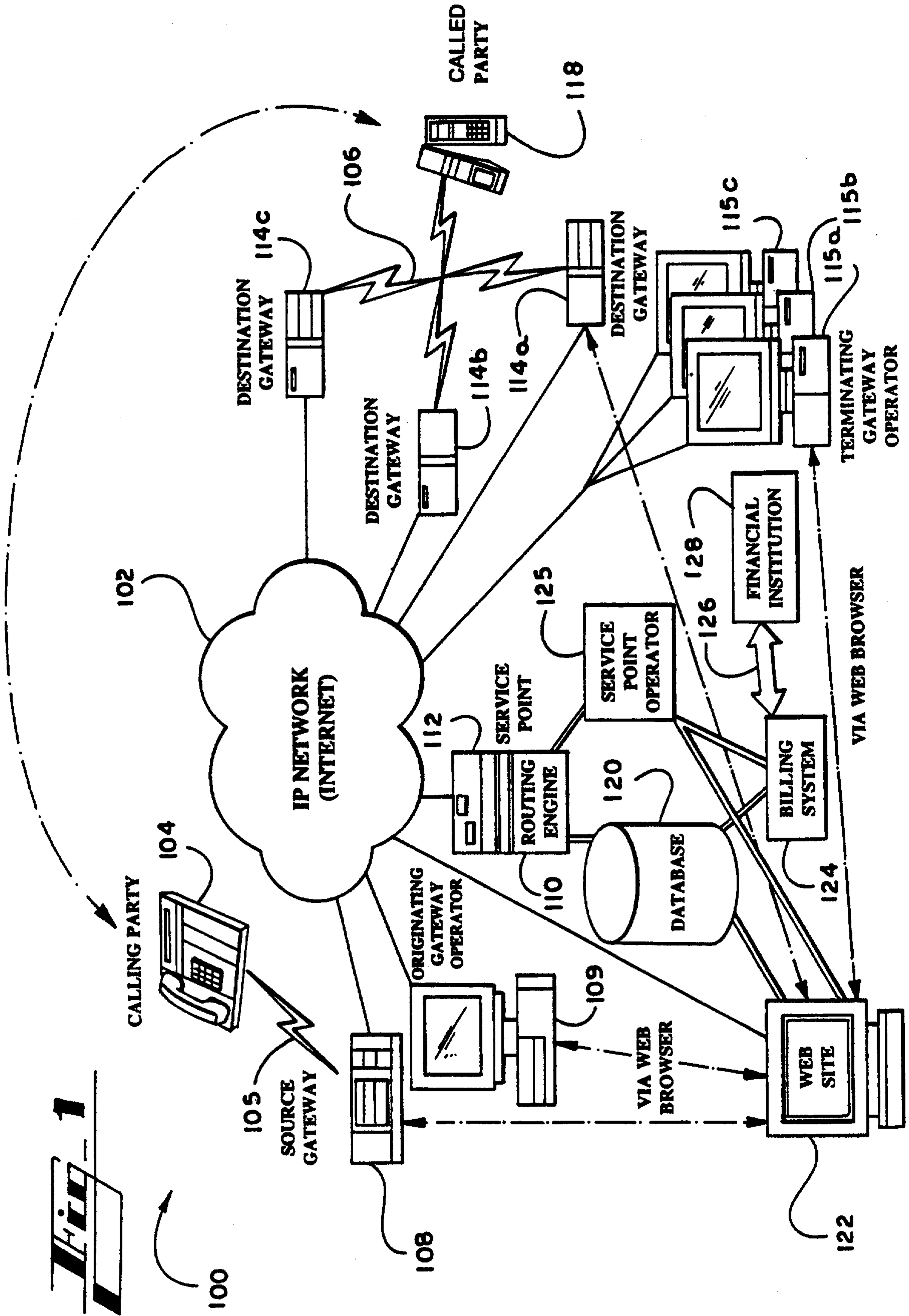

2/12

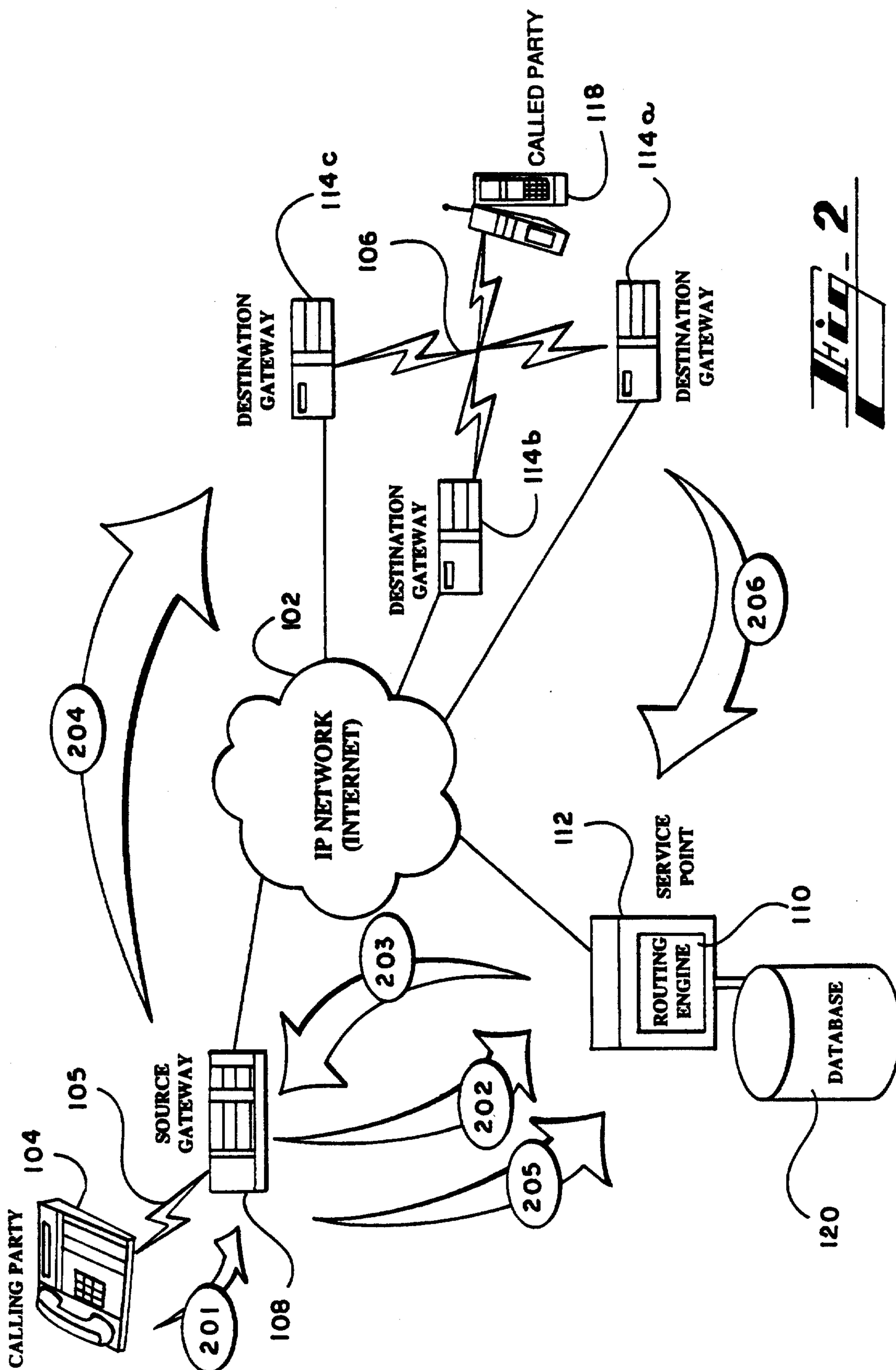

WO 99/14931

3/12

PCT/US98/19254

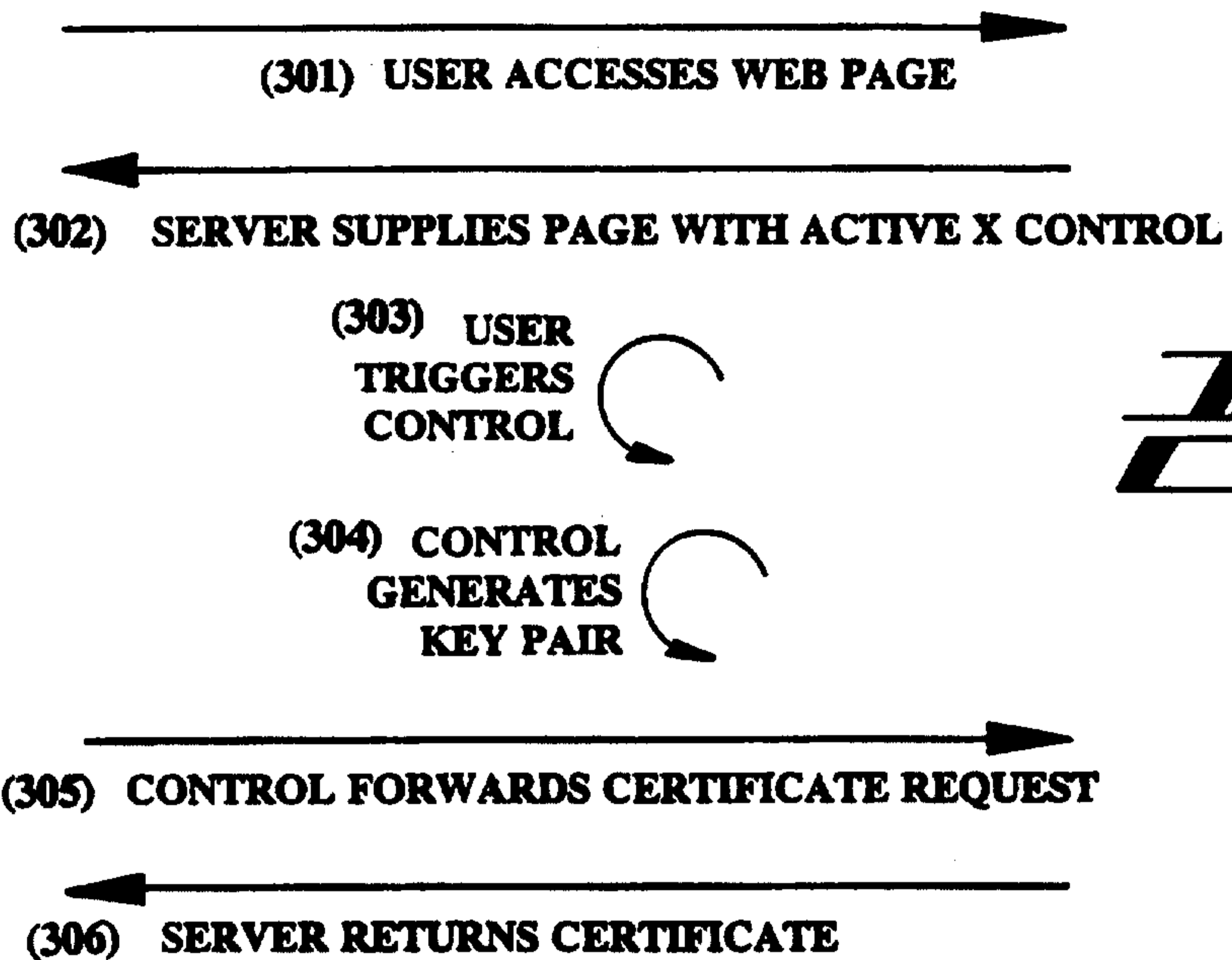
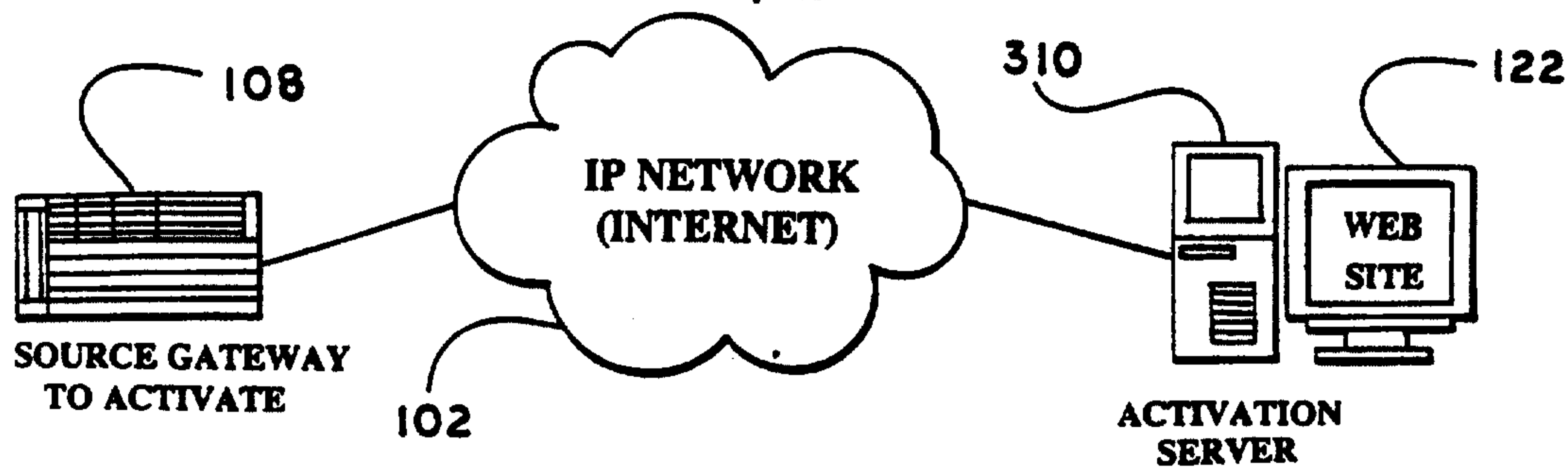
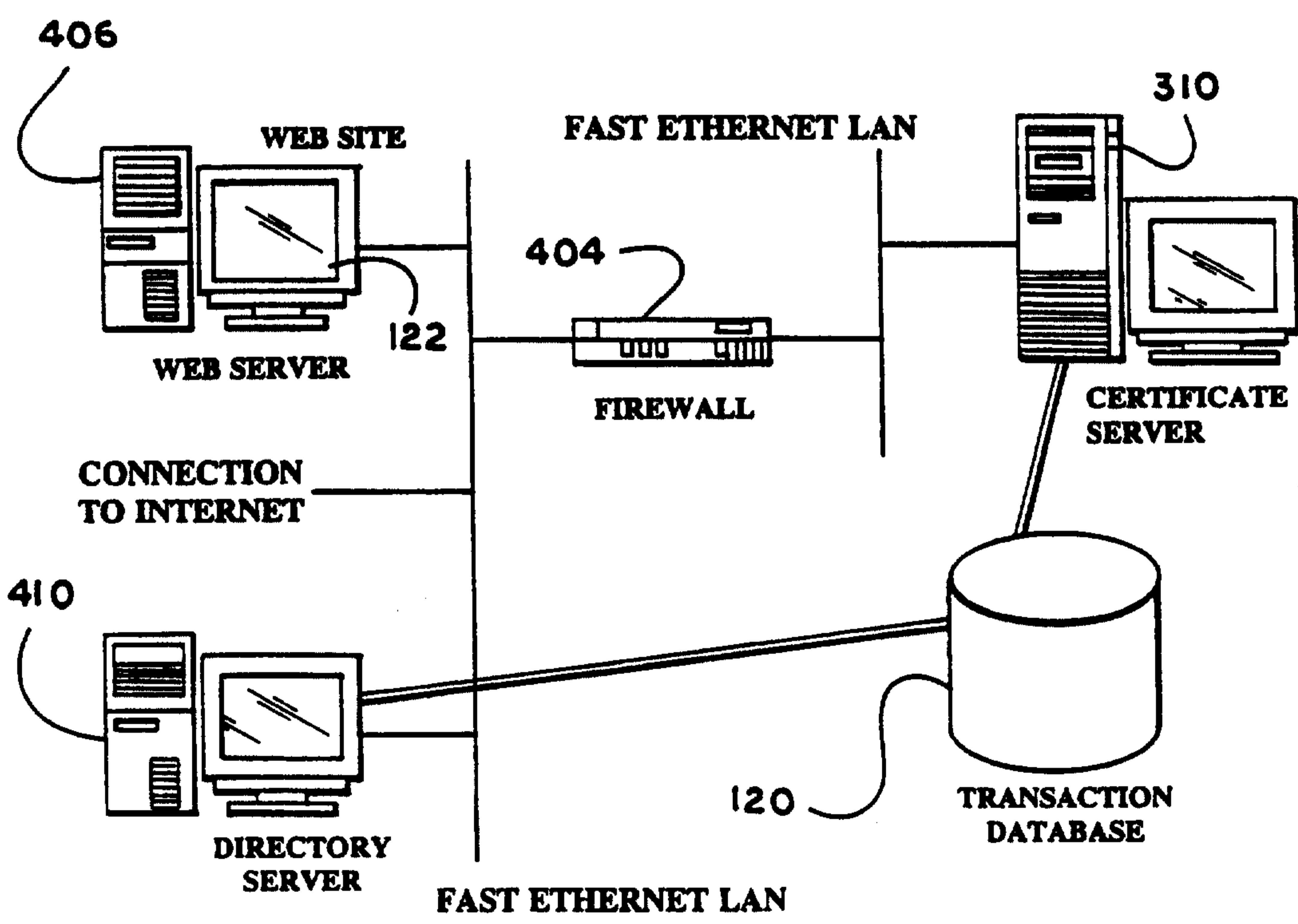

Fig. 3

Fig. 4



WO 99/14931

PCT/US98/19254

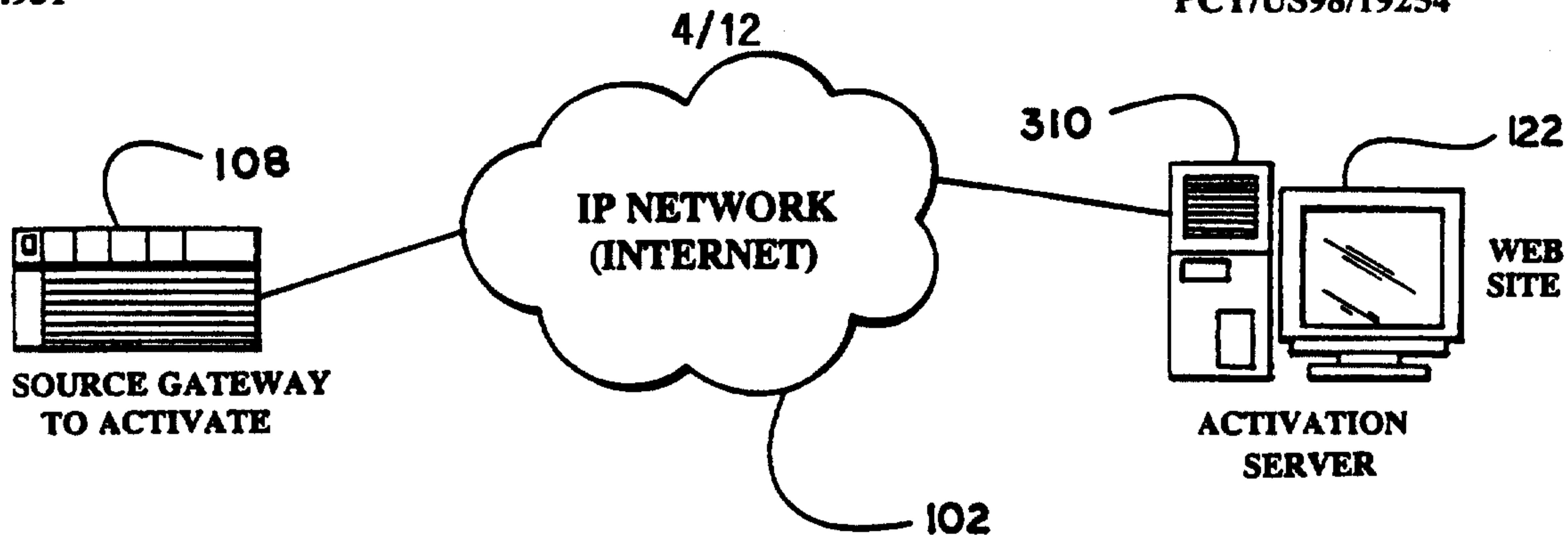

(501) DEVICE REQUESTS DOWNLOAD

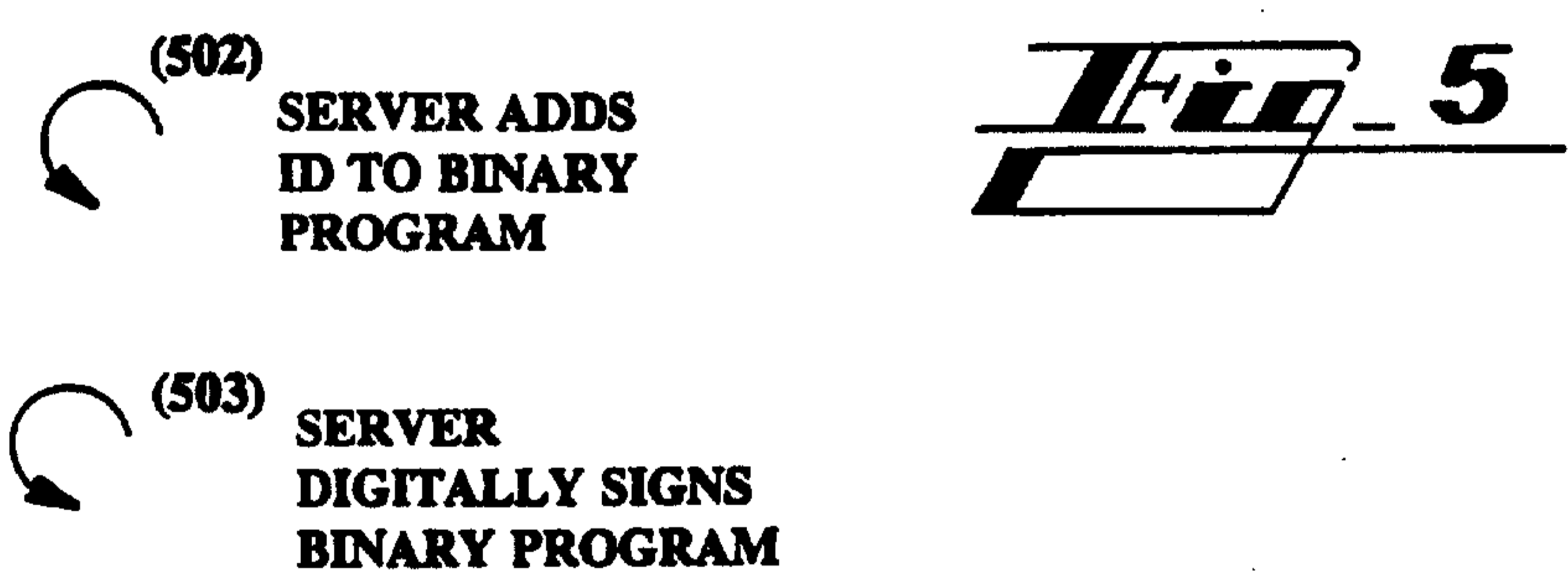

(504) SERVER DISTRIBUTES ACTIVATION PROGRAM

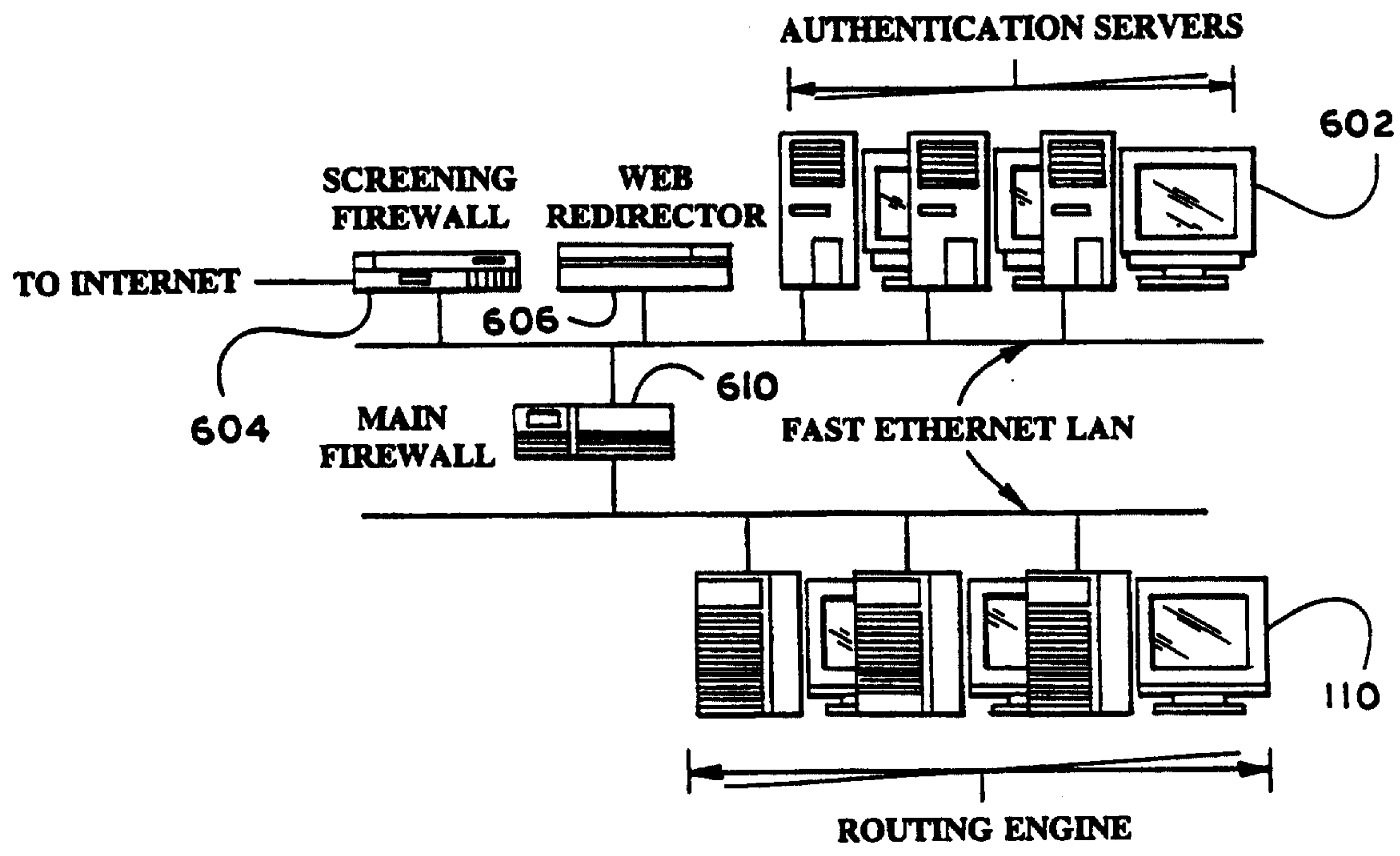

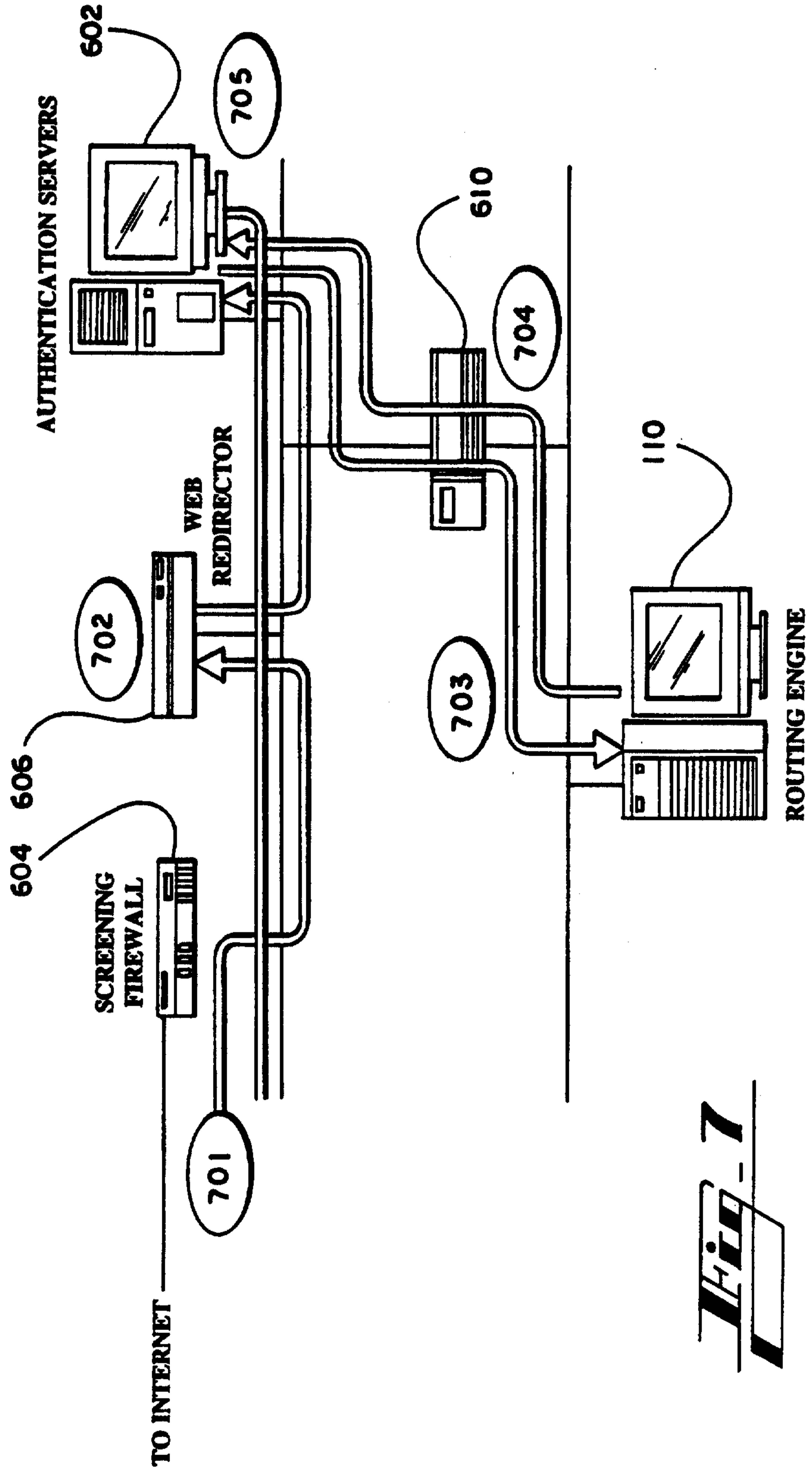

Fig. 7

802	804	806	808	810	812	814	816	820	822	824	826
SOURCE GATEWAY ID	PREFIX	EFFECTIVE DATE	START DAY	START HOUR	END DAY	END HOUR	LONGEST PREFIX	PRICE	TIME UNIT	#ENTRIES	OFFSET
1	1404	1/1/98	1	0	7	23	6	.20	0.2	3	0
1	1770	12/1/97	4	12	6	23	6	.30	1.0	3	1
1	177095	11/1/97	6	15	7	23	6	.25	1.5	3	2

801

1002

1004

1001

TERMINATING NUMBER PREFIX	DESTINATION GATEWAY ID	OTHER DATA
1770	1	...
1770	2	...
46	1	...
46	2	...



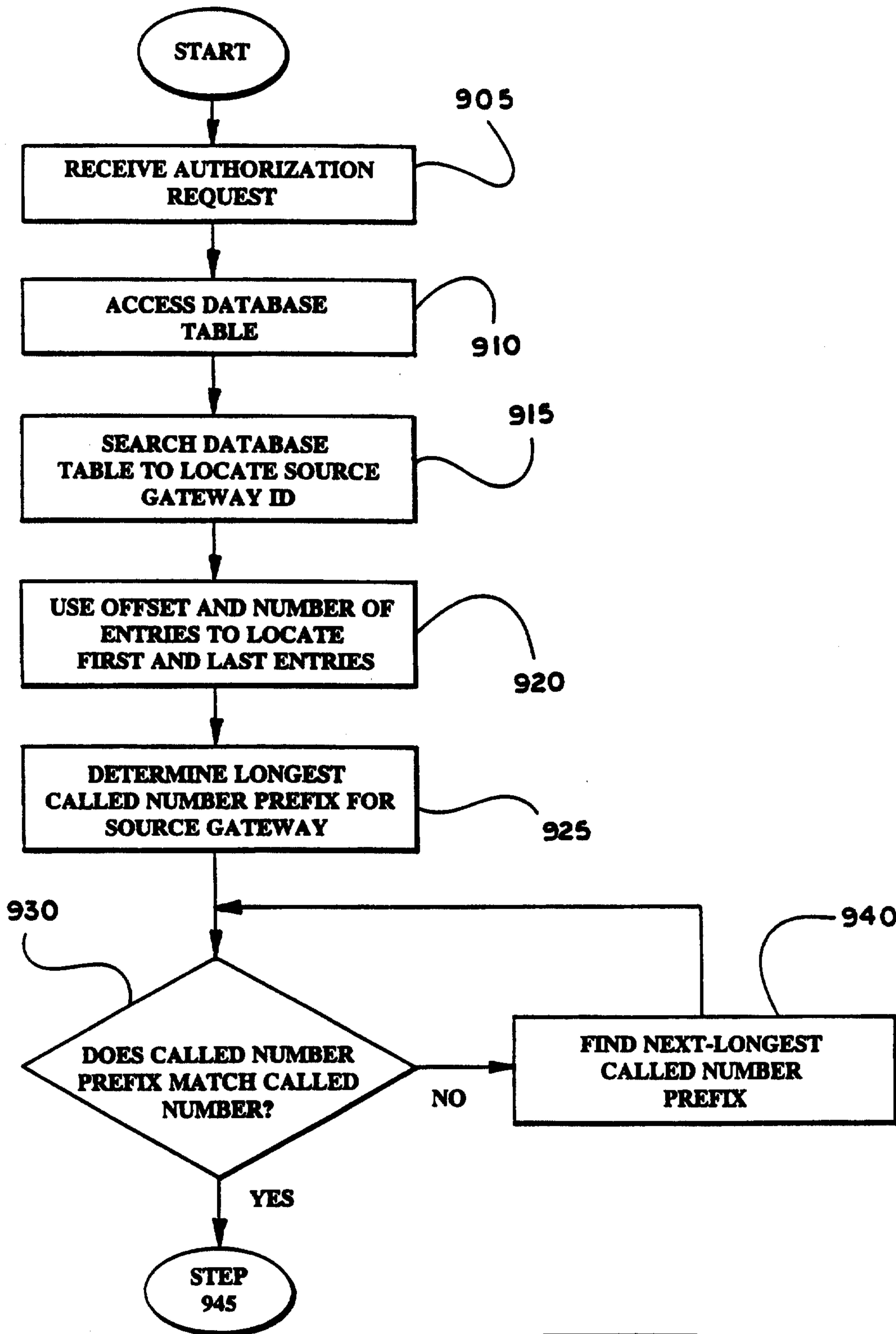
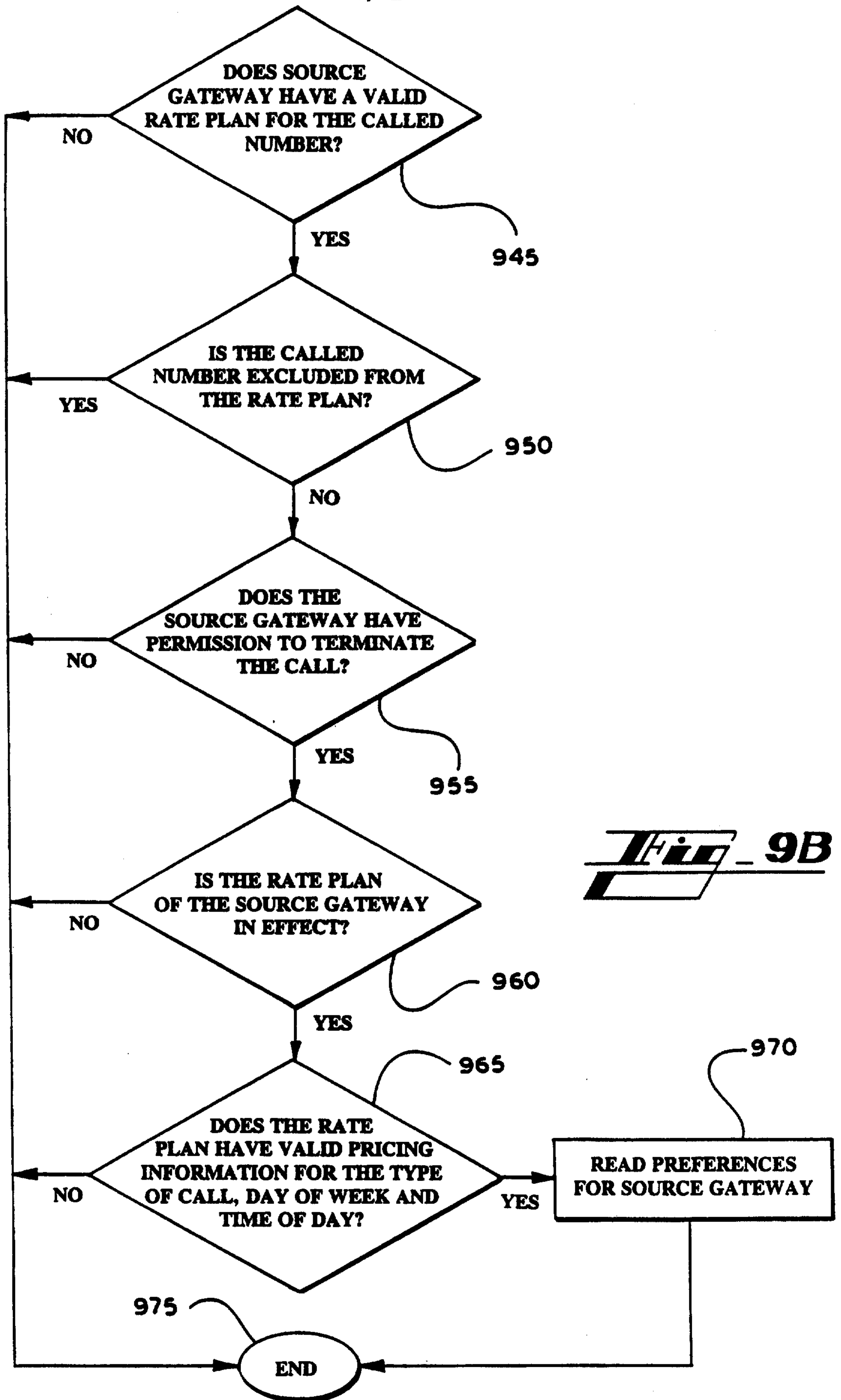

FIG. 9A



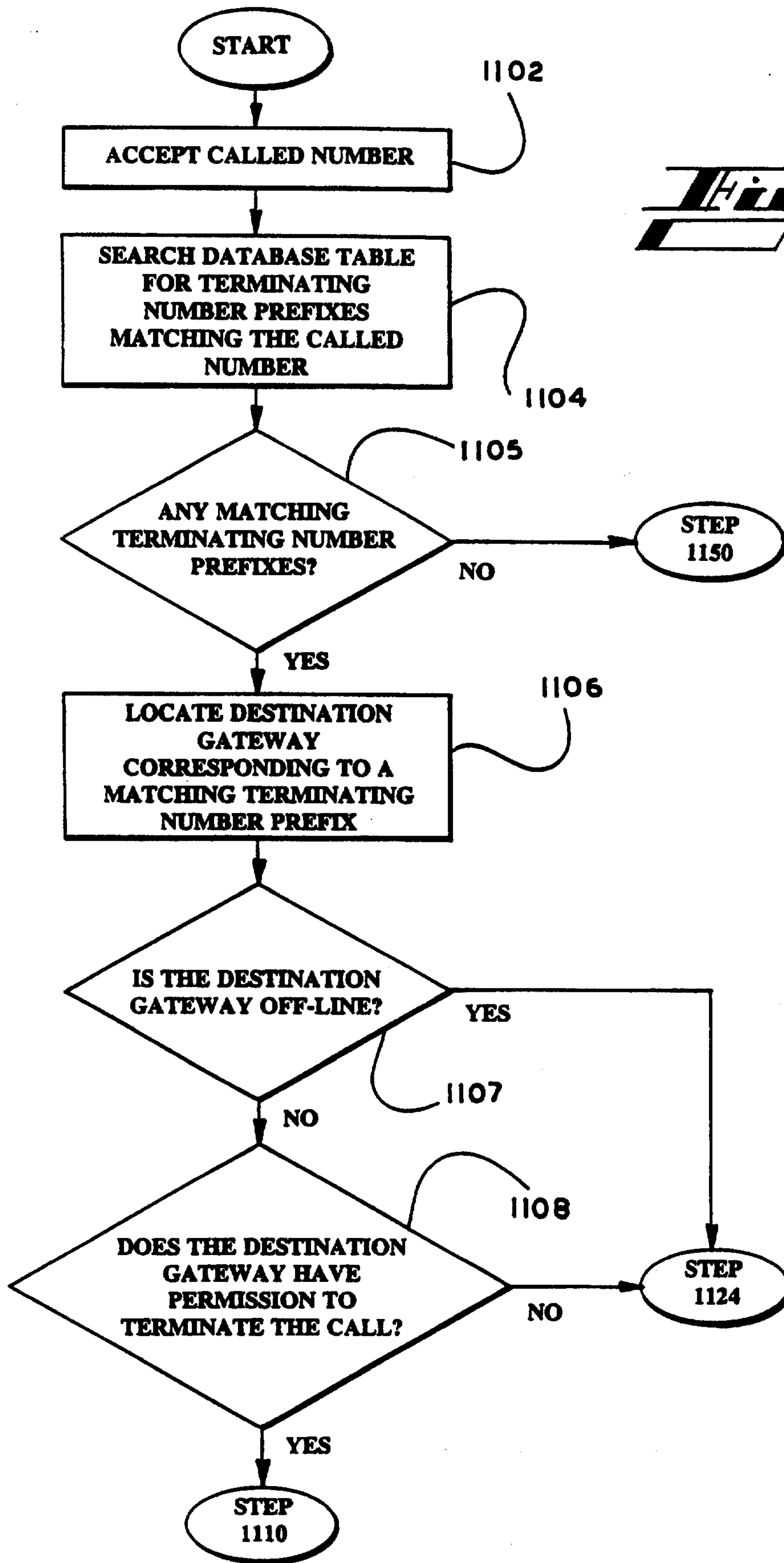

Fig. 11A

Fig. 11B

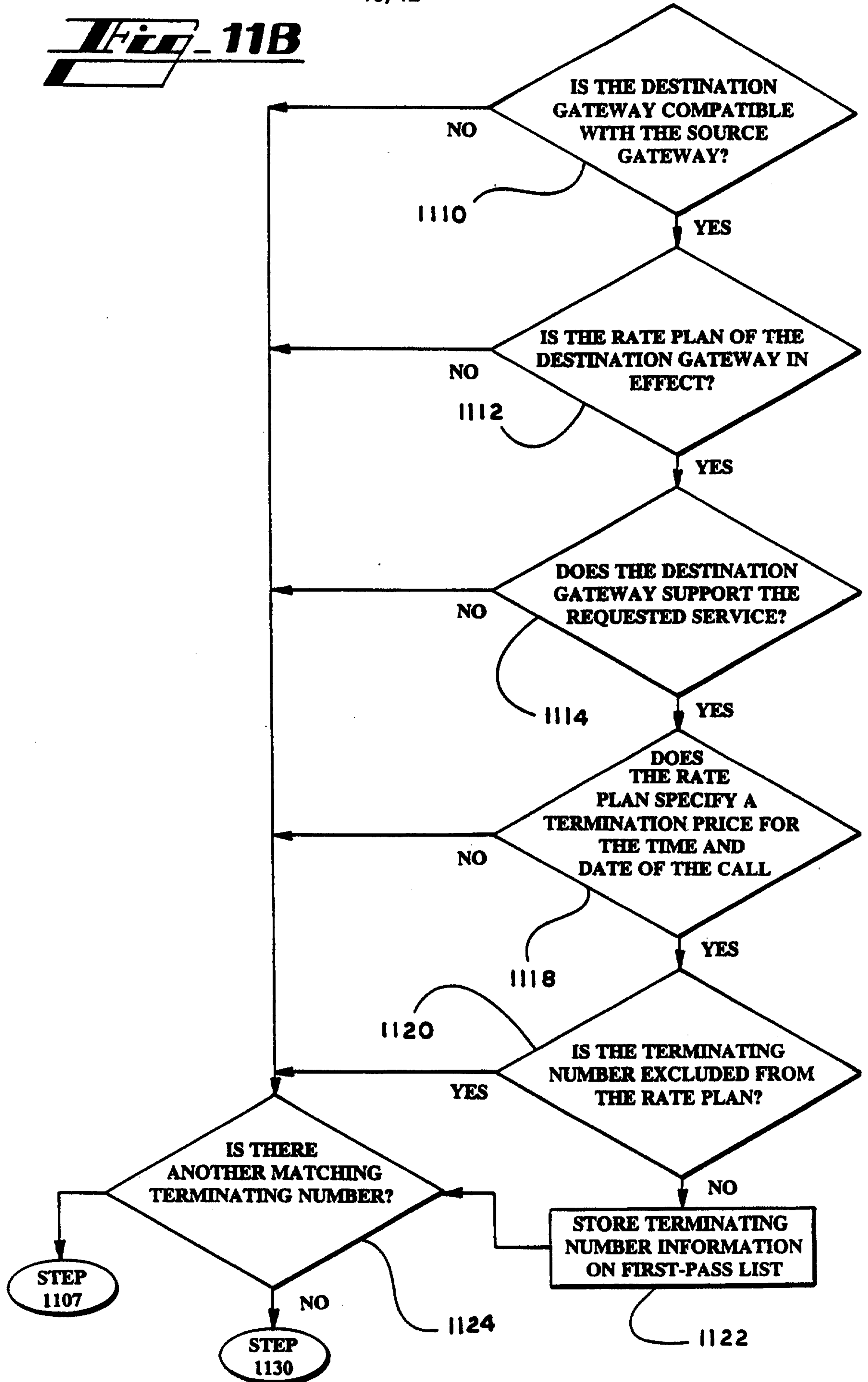

Fig. 11C

