



US00D648307S

(12) **United States Design Patent**
Choi et al.

(10) **Patent No.:** **US D648,307 S**

(45) **Date of Patent:** **** Nov. 8, 2011**

(54) **MOBILE PHONE**

(75) Inventors: **Woong Choi**, Seoul (KR); **Hyejin Kim**, Gyeonggi-do (KR); **Yunjin Park**, Seoul (KR); **Seungchul Cho**, Seoul (KR)

(73) Assignee: **LG Electronics Inc.**, Seoul (KR)

(**) Term: **14 Years**

(21) Appl. No.: **29/386,926**

(22) Filed: **Mar. 7, 2011**

(30) **Foreign Application Priority Data**

Sep. 10, 2010 (KR) 30-2010-0040069

(51) **LOC (9) Cl.** **14-03**

(52) **U.S. Cl.** **D14/138 AA**

(58) **Field of Classification Search** D14/138 AA, D14/496, 341, 345, 346, 203.3, 203.4, 203.7, D14/138 AB, 138 AD, 138 R, 147, 218, 137; 455/575.1, 556.2, 575.3, 575.4; D21/517; 379/433.01, 433.04, 433.11, 433.12, 433.13
See application file for complete search history.

(56) **References Cited**

U.S. PATENT DOCUMENTS

D526,637 S *	8/2006	Shin	D14/138 AA
D542,764 S *	5/2007	Lee et al.	D14/138 AA
D543,182 S *	5/2007	Lee et al.	D14/138 AA
D543,184 S *	5/2007	Moon et al.	D14/138 AA
D543,186 S *	5/2007	Kim et al.	D14/138 AA
D546,802 S *	7/2007	Cho et al.	D14/138 AA
D573,970 S *	7/2008	Park	D14/138 AA
D576,993 S *	9/2008	Park et al.	D14/138 AA
D596,603 S *	7/2009	Tkachuk	D14/138 AA
D597,056 S *	7/2009	Tkachuk	D14/138 AA
D598,413 S *	8/2009	Chen	D14/138 AA
D608,758 S *	1/2010	Nahal et al.	D14/138 AA
D611,017 S *	3/2010	Loh et al.	D14/138 AA
D617,292 S *	6/2010	Chen et al.	D14/138 AA
D617,761 S *	6/2010	Wang	D14/138 AA

D620,466 S *	7/2010	Kim et al.	D14/138 AA
D628,186 S *	11/2010	Yang	D14/138 AA
D632,276 S *	2/2011	Chen	D14/138 AA
D636,366 S *	4/2011	Chen	D14/138 AA
D639,264 S *	6/2011	Tsai	D14/138 AA

OTHER PUBLICATIONS

LG A120 telephone, announced Dec. 2010, [online], [site visited Aug. 23, 2011]. Available from Internet, <URL: http://www.gsmarena.com>.*
Sony Ericsson K510 telephone, announced Feb. 2006, [online], [site visited Aug. 23, 2011]. Available from Internet, <URL: http://www.gsmarena.com>.*
Motorola W233 telephone, announced Jan. 2009, [online], [site visited Aug. 23, 2011]. Available from Internet, <URL: http://www.gsmarena.com>.*
Vodafone 226 telephone, announced Jul. 2007, [online], [site visited Aug. 23, 2011]. Available from Internet, <URL: http://www.gsmarena.com>.*
Alcatel OT-300 telephone, announced Feb. 2010, [online], [site visited Aug. 23, 2011]. Available from Internet, <URL: http://www.gsmarena.com>.*

* cited by examiner

Primary Examiner — Jeffrey D Asch
(74) *Attorney, Agent, or Firm* — Morgan, Lewis & Bockius LLP

(57) **CLAIM**

The ornamental design for a mobile phone, as shown and described.

DESCRIPTION

FIG. 1 is a perspective view of a mobile phone showing our new design;
FIG. 2 is a front view thereof;
FIG. 3 is a rear view thereof;
FIG. 4 is a left side view thereof;
FIG. 5 is a right side view thereof;
FIG. 6 is a top plan view thereof; and,
FIG. 7 is a bottom plan view thereof.

1 Claim, 6 Drawing Sheets

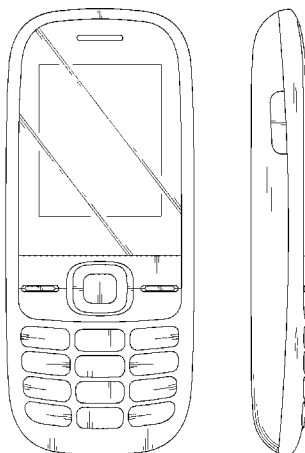

FIG. 1

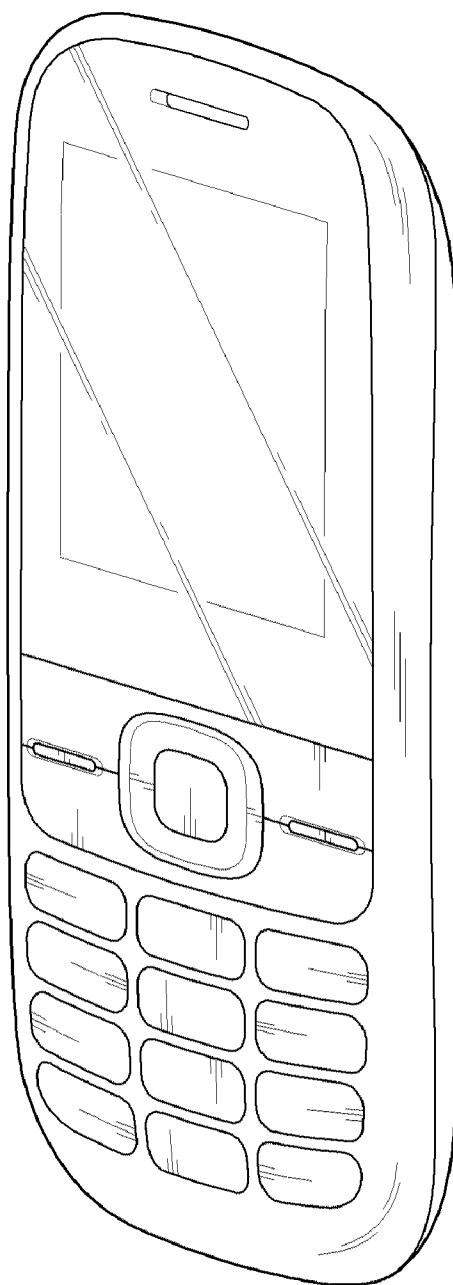

FIG. 2

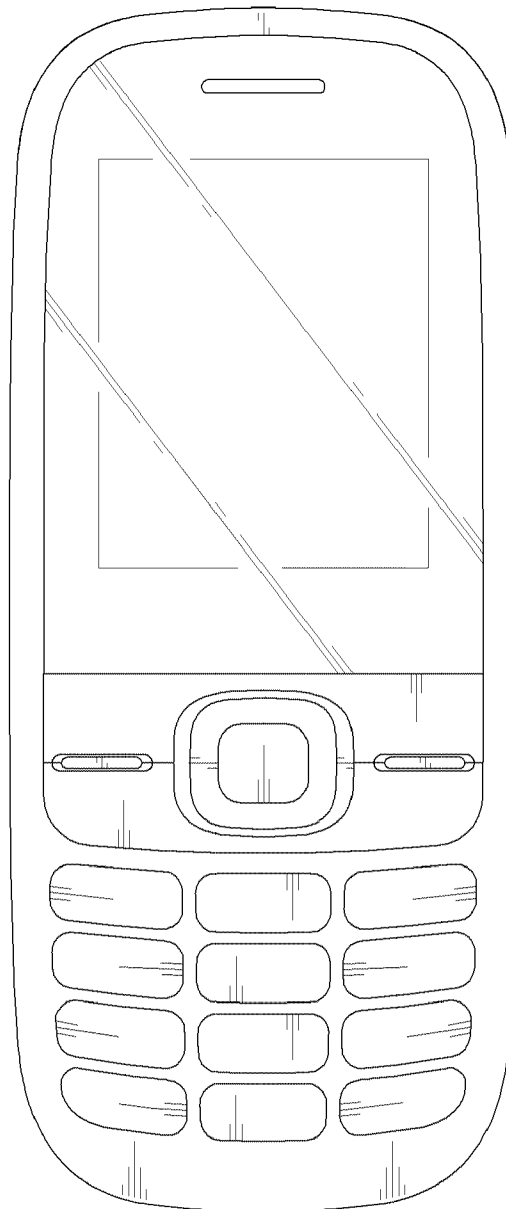

FIG. 3

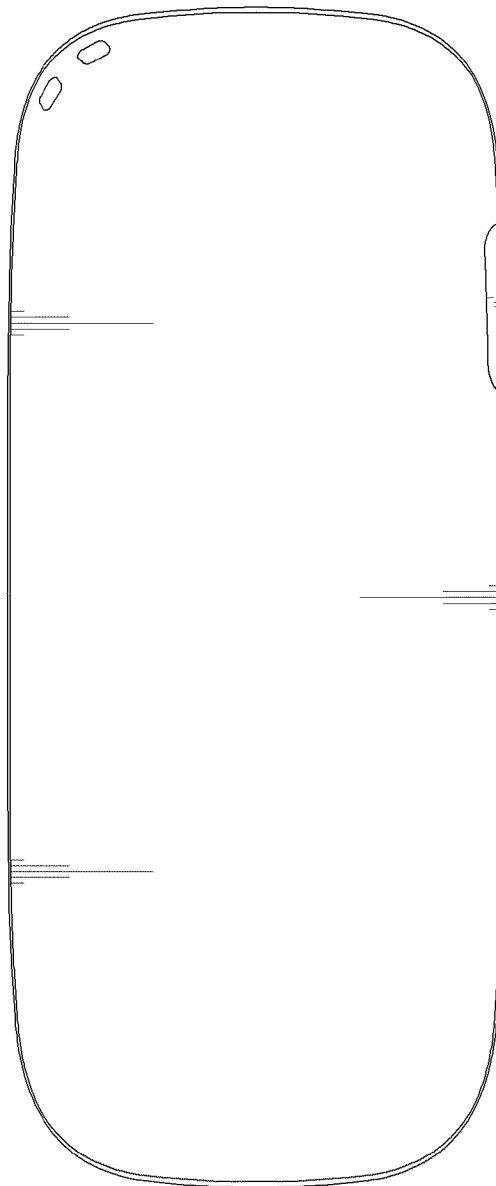

FIG. 4

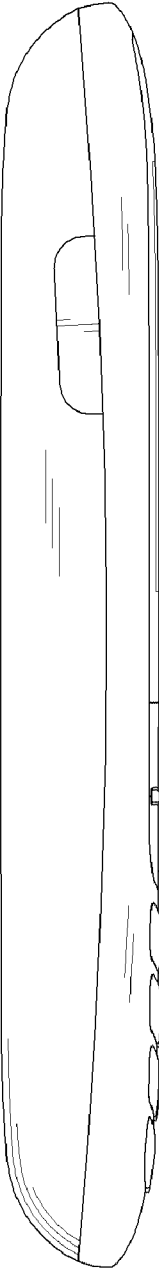

FIG. 5

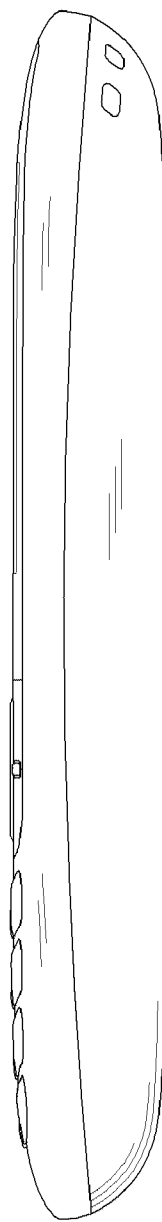

FIG. 6

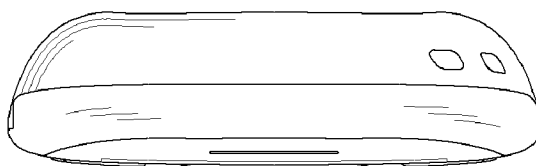

FIG. 7

