

PCT

WORLD INTELLECTUAL PROP.  
International B



INTERNATIONAL APPLICATION PUBLISHED UNDER

(51) International Patent Classification <sup>6</sup> :  
H04N 5/445, 7/087

A1

(11) Int

WO 9607270A1

(43) International Publication Date: 7 March 1996 (07.03.96)

(21) International Application Number: PCT/US95/11173

(22) International Filing Date: 31 August 1995 (31.08.95)

(30) Priority Data:  
08/298,997 31 August 1994 (31.08.94) US  
08/312,863 27 September 1994 (27.09.94) US  
08/369,522 5 January 1995 (05.01.95) US  
08/424,863 17 April 1995 (17.04.95) US  
08/475,395 7 June 1995 (07.06.95) US

(60) Parent Application or Grant  
(63) Related by Continuation  
US 08/475,395 (CIP)  
Filed on 7 June 1995 (07.06.95)

(71)(72) Applicants and Inventors: YUEN, Henry, C. [US/US]; P.O. Box 1159, Redondo Beach, CA 90278 (US). KWOH, Daniel, S. [US/US]; 3975 Hampstead Road, La Canada/Flintridge, CA 91011 (US). MANKOVITZ, Roy, J. [US/US]; 18057 Medley Drive, Encino, CA 91316 (US). LEUNG, Elsie, Y. [US/US]; 1302 Via Del Rey, South Pasadena, CA 91030 (US).

(74) Agent: RAHN, Leroy, T.; Christie, Parker & Hale, Suite 500, 350 West Colorado Boulevard, P.O. Box 7068, Pasadena, CA 91109-7068 (US).

(81) Designated States: AM, AT, AU, BB, BG, BR, BY, CA, CH, CN, CZ, DE, DK, EE, ES, FI, GB, GE, HU, IS, JP, KE, KG, KP, KR, KZ, LK, LR, LT, LU, LV, MD, MG, MN, MW, MX, NO, NZ, PL, PT, RO, RU, SD, SE, SG, SI, SK, TJ, TM, TT, UA, UG, US, UZ, VN, European patent (AT, BE, CH, DE, DK, ES, FR, GB, GR, IE, IT, LU, MC, NL, PT, SE), OAPI patent (BF, BJ, CF, CG, CI, CM, GA, GN, ML, MR, NE, SN, TD, TG), ARIPO patent (KE, MW, SD, SZ, UG).

Published  
With international search report.

(54) Title: METHOD AND APPARATUS FOR DISPLAYING TELEVISION PROGRAMS AND RELATED TEXT

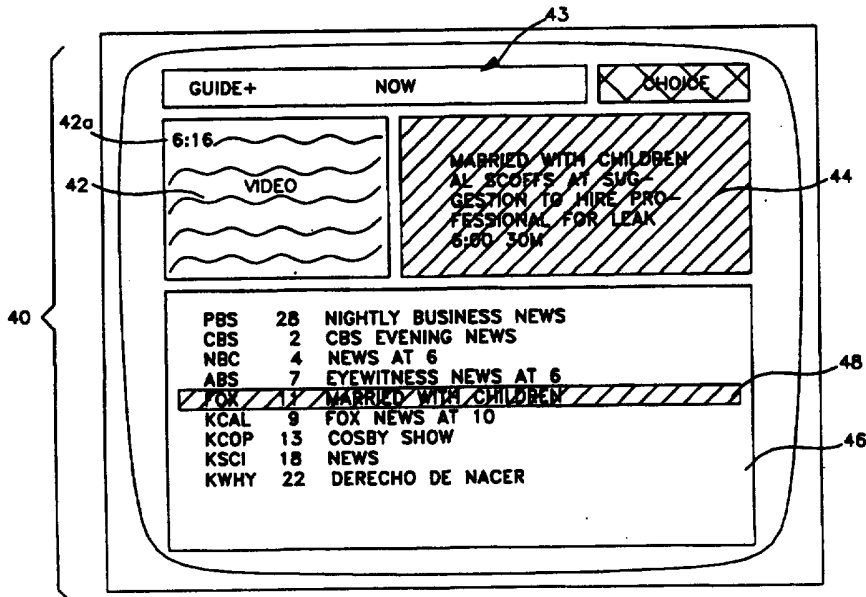

(57) Abstract

A television viewer uses a PIP format for display of program related information (46) such as television program listings from a program schedule data base (22) in the background and moving, real time or stored video clip images of a program selected from the displayed listings in the PIP window (42). All the text of the background information lies outside the PIP window. In one embodiment, as the viewer selects a particular program from the display of current television program listings by means of a cursor (48) or a code number, the corresponding program automatically appears in the PIP window.

**FOR THE PURPOSES OF INFORMATION ONLY**

Codes used to identify States party to the PCT on the front pages of pamphlets publishing international applications under the PCT.

AT	Austria	GB	United Kingdom	MR	Mauritania
AU	Australia	GE	Georgia	MW	Malawi
BB	Barbados	GN	Guinea	NE	Niger
BE	Belgium	GR	Greece	NL	Netherlands
BF	Burkina Faso	HU	Hungary	NO	Norway
BG	Bulgaria	IE	Ireland	NZ	New Zealand
BJ	Benin	IT	Italy	PL	Poland
BR	Brazil	JP	Japan	PT	Portugal
BY	Belarus	KE	Kenya	RO	Romania
CA	Canada	KG	Kyrgystan	RU	Russian Federation
CF	Central African Republic	KP	Democratic People's Republic of Korea	SD	Sudan
CG	Congo	KR	Republic of Korea	SE	Sweden
CH	Switzerland	KZ	Kazakhstan	SI	Slovenia
CI	Côte d'Ivoire	LI	Liechtenstein	SK	Slovakia
CM	Cameroon	LK	Sri Lanka	SN	Senegal
CN	China	LU	Luxembourg	TD	Chad
CS	Czechoslovakia	LV	Larvia	TG	Togo
CZ	Czech Republic	MC	Monaco	TJ	Tajikistan
DE	Germany	MD	Republic of Moldova	TT	Trinidad and Tobago
DK	Denmark	MG	Madagascar	UA	Ukraine
ES	Spain	ML	Mali	US	United States of America
FI	Finland	MN	Mongolia	UZ	Uzbekistan
FR	France			VN	Viet Nam
GA	Gabon				

1

## METHOD AND APPARATUS FOR DISPLAYING TELEVISION PROGRAMS AND RELATED TEXT

### 5 Background of the Invention

This invention relates to the field of television and, more particularly, to a method and apparatus for simultaneously displaying video programs and related text on a television screen.

10

For a number of years television receivers have been equipped with picture-in-picture (PIP) capability. In PIP format, the moving, real time images of one television channel are displayed on the background of the screen and the moving, real time images of another television channel are displayed in a PIP window overlaid on a small area of the background. Because two channels are simultaneously displayed by the television receiver, two tuners are required. The viewer enters the PIP mode by pressing a PIP key of his or her controller. Then, the viewer can change either the channel of the background or the channel of the PIP by resetting the appropriate tuner. To reverse the background and PIP images, the viewer simply presses a SWAP key. To collapse the PIP window, the viewer again presses the PIP key.

15

20

Television program guides help television viewers select programs to watch. Such television program guides list the available television programs by day of the week, time of day, channel, and program title. For many years television program guides have been published in hard copy form. More recently as illustrated by Levine Patent 4,908,713, television program guides have begun to take an electronic form. In other words, the schedule of program listings is stored in an electronic memory connected to the television receiver. The program listings are recalled from memory by the viewer on command for display on the television screen.

25

30

Despite the prevalence of television program guides, many viewers still make their program selections by switching the television tuner from channel to channel and observing on the screen what program is being received on the respective channels. This process is sometimes called "grazing."

35

Emanuel Patent 5,161,019 discloses an automated form of channel grazing. A preselected group of channels are sequentially scanned by switching the tuner of the television receiver from channel to channel. A still image of the program received on each channel is stored in a memory. After all the channels have been scanned, the still images from all the channels are simultaneously displayed on the television screen. This process gives the viewer more information about the program choices in addition to that obtainable from a television program guide, namely, the displayed still images of the actual programs.

1 **Summary of the Invention**

According to the invention, the moving images of a television program are displayed in a PIP window on the screen of a television monitor and textual information related to the television program is displayed in the background on the screen. Preferably, the audio portion of the television program displayed in the PIP window is also reproduced by the sound system of the television monitor. The textual information is arranged on the screen so none of it is covered by the moving images.

In one embodiment, the textual program related information (PRI) is a television program schedule. One of the program listings of the schedule identifies by title and time and/or channel the television program in the PIP window, which comprises moving images.

To facilitate channel grazing, a television viewer can use a PIP format for display of current television program listings from a program schedule data base in the background and moving, real time images of a program selected from the displayed listings in the PIP window. Specifically, as the viewer selects a particular program from the displayed current television program listings by means of a cursor or a code number, the corresponding program automatically appears in the PIP window. In this way, the viewer can channel graze by sequentially selecting the individual program listings in the background. When the viewer finds a program that the viewer wishes to watch, the viewer leaves the PIP format and returns to full screen television viewing, the tuner already being set to the desired program. To do this the viewer can reverse the background and PIP window and then collapse the window, leaving the desired program on the full screen or apparatus can be configured to return to full screen viewing in a single step.

To permit the viewing of programs scheduled for future broadcast without losing sight of the current program being watched, a television viewer can use a PIP format for display of television program listings for a specific channel from a program schedule data base in the background and moving, real time images of the current program on that channel in the PIP window. Specifically, as the viewer changes channels, the current program on that channel automatically appears in the PIP window. The viewer can control the background to display program listings for a period of days, e.g. a week, in the future. In this way, the viewer can continue to watch a television program while ascertaining the future programs on the channel to which the television tuner is set. When the viewer finds a program that the viewer wishes to watch, the background disappears, leaving the program on the channel to which the tuner is set on the full screen.

In another embodiment, a television viewer can use a PIP format for display of future television program listings from a program schedule data base in the background and moving images of a video clip of one of the program listings in the background display selected for example by a cursor.

1 In yet another embodiment, the textual program related information (PRI) is a message that is broadcast in the vertical blanking interval of the television signal contemporaneously with the television program displayed in the PIP window.

### **Brief Description of the Drawings**

5 The features of specific embodiments of the best mode contemplated of carrying out the invention are illustrated in the drawings, in which:

FIG. 1 is a schematic block diagram of a television receiver that has an electronic television program guide incorporating the principles of one embodiment of the invention;

10 FIGS. 2 to 5 are television screens formatted in accordance with the embodiment of FIG. 1;

FIG. 6 is a top plan view of a remote controller for operating the electronic program guide of FIG. 1;

15 FIGS. 7 to 14 are flow diagrams showing how a viewer navigates through the electronic program guide of FIG. 1 and the screen formats encountered by the viewer during such navigation;

FIG. 15 is a schematic diagram depicting the hierarchy of prompts and guides shown in FIGS. 7 to 14;

FIGS. 16 and 17 are screens formatted to designate by color coding the title of the program in the PIP window and the title of the program in the program description area;

20 FIG. 18 is a screen formatted to display a real time television program with an electronic program guide, and thereby simulate the screen format of FIG. 2, 3, 4, or 5, with a television receiver that does not have a PIP chip;

FIG. 19 is a graph illustrating an alternative way for the viewer to navigate through the television program guide;

25 FIG. 20 is a schematic block diagram of a television receiver that has an electronic television program guide that displays PRI in accordance with the principles of another embodiment of the invention; and

FIG. 21 is a screen formatted to display the PRI recovered by the receiver of FIG. 20;

30 FIG. 22 is a diagram of the RAM memory data base that illustrates the static and dynamic areas of memory.

FIG. 23 is a diagram of the download packet received by the system.

FIG. 24 is a representation of the memory bit map contained in the RAM memory.

FIG. 25 is a representation of the pre-established time list data structure contained in the static area of the RAM memory.

35 FIG. 26 is an illustration of a show information package data structure.

FIG. 27 is an illustration of a section of a show information package data structure.

FIG. 28 is an illustration of an extended theme show list.

1 FIG. 29 is a representation of the channel map data structure contained in the static area of the RAM memory.

FIG. 30 is a representation of the control array data structure contained in the static area of the memory.

5 FIG. 31 is a representation of the call letter map data structure located in the static area of the RAM memory.

FIG. 32 is a representation of the record queue data structure located in the static area of the RAM memory.

10 FIGS. 33 to 35 are television screens formatted in accordance with another embodiment of the invention;

FIGS. 36 to 38 are flow diagrams showing how a viewer navigates through the electronic program guide of FIG. 1 that includes the screen formats of FIGS. 33 to 35; and

FIG. 39 is a schematic diagram depicting the hierarchy of prompts and guides shown in FIGS. 36 to 38.

### 15 Detailed Description of a Specific Embodiment

In the following description of the embodiments of the invention, common reference numerals are used to represent the same components. If the features of all the embodiments are incorporated into a single system, these components can be shared and perform all the functions of the described embodiments.

20 In a preferred embodiment, the invention displays information about television program schedules and content in a tripartite electronic television program guide. One screen format is a time specific program guide (TISPG); another screen format is a channel specific program guide (CSPG); and the third screen format is a theme specific program guide (THSPG). In each case, the moving images of a currently broadcast television program are displayed in real time in a PIP window.

25 With reference to FIG. 1, a source of television signals 10 such as a terrestrial antenna, or a cable is connected to a television tuner 11. The output of tuner 11 is a modulated intermediate frequency signal containing video and audio television information. Tuner 11 is connected by an intermediate frequency amplifier (IF AMP) 12 to a picture detector (PICTURE DET) 13 and a sound detector (SOUND DET) 14, which produce base band video and audio signals, respectively. The audio signal is coupled by a sound amplifier (SOUND AMP) 15 to a loudspeaker 16. The video signal is coupled by a video amplifier not shown to one input of a switch 18. Sound detector 14 and picture detector 13 are connected to the audio and video inputs, respectively, of a video cassette recorder (VCR) 17. 30 (Alternatively, television signal source 10 could be directly connected to the RF input of VCR 17, if its internal tuner and demodulating circuitry is to be utilized.) The output of VCR 17 is connected to the other input of switch 18. The output of switch 18 is connected to one input of a conventional picture-in-picture (PIP) integrated circuit chip 19. The output of PIP 35

1 chip 19 is connected to the video input of a television receiver or monitor (TV) 20 having a screen (not shown).

5 An updatable data base of the schedule of program listings of all the available channels for a prescribed period of time, e.g. a day or a week, is electronically stored in a program schedule memory 22. These program listings typically include for each program the title, a program description, the day of the week, the start time of the day, the program length, and the channel on which the program is transmitted and thus available for reception at source 10. In a preferred embodiment of the invention, the period of time for which the program listings are stored is different for the guides, depending upon viewer priorities and preferences. For example, the information needed to display the TISPG and CSPG may be stored for one or two days and the information needed to display the TSPG may be stored for a week or more. The data base can be updated by a continuous data link in the vertical blanking interval (VBI) of one television channel broadcast to the television receiver in well known fashion. Alternatively, the data base can be updated by unplugging memory 22 and replacing it with a memory having the updated data base. Memory 22 is connected to a microprocessor 24 that is programmed to control the operation of the described equipment. An operating program for microprocessor 24 is stored in a read only memory (ROM) 26. A viewer input device 28, preferably in the form of a remote IR controller, is coupled to microprocessor 24 to provide commands from the viewer. A video processor 30 is coupled to microprocessor 24. When the viewer wishes to see television program listings, microprocessor 24 recalls a portion of the program schedule data base from memory 22 and couples it to video processor 30, where the program listings are formatted for display. Preferably, the information stored in video processor 30 is a bit map of what is displayed on the screen of television receiver 20. Video processor 30 is connected to the other input of PIP chip 19. Preferably, viewer input device 28 controls microprocessor 24 by cursor movement on the screen of television receiver 20. To this end, microprocessor 24 and video processor 30 are coupled to a cursor position register 32. (Alternatively, the viewer can select items of information displayed on the screen by keying into viewer input device 28 code numbers assigned to these items.) Microprocessor 24 is also coupled to tuner 11 for channel change, to VCR 17 for play/record selection and start/stop, to switch 18 for selection of one of its inputs, and to PIP chip 19 for selection of the mode of PIP operation.

35 The formats of the electronic program guide are shown in FIGS. 2 to 5. Each format has a background area 40 and an overlaid PIP window 42 in the upper left-hand corner of the screen. The real time, i.e., 6:15 p.m., is displayed in a sub-area 42a PIP window 42. Background area 40 includes a banner and message prompting area 43 at the top of the screen, a program description area 44 in the upper right-hand corner of the screen adjacent to PIP window 42, and a program schedule area 46 below areas 42 and 44. Program description area 44 includes the start time and length (duration) of the program being

1 described. The viewer can move a cursor 48 vertically to highlight one of the program  
listings displayed in area 46. The highlighted background of cursor 48 and the background  
of program description area 44 are the same color or shade. In each format, the complete,  
moving images of a currently broadcast television program in real time and the current time  
5 are displayed in PIP window 42 and the audio portion of the television program displayed  
in PIP window 42 is reproduced by the sound system of monitor 20. The information  
displayed in areas 43, 44, and 46 varies depending upon the format.

One version of the TISPG screen format is shown in FIG. 2, namely a version that  
displays program listings of television programs being broadcast at the current time. In the  
10 following description, this format is sometimes called the "NOW" guide or the "ALL  
CHANNEL" guide. Program schedule area 46 has a column for channel name or call  
letters, a column for channel number, and a column for program title; each line of area 46  
represents a separate program listing. The moving, real time images of the current television  
program highlighted by cursor 48 are displayed in PIP window 42 and a brief program  
15 description of the highlighted program is displayed in area 44.

In FIG. 3 another version of the TISPG screen format displays in area 46 program  
listings being broadcast at a future time, i.e., 8:00 p.m. In the following description, this  
format is sometimes called the "NEXT" guide. The viewer can select the future time of the  
program listings to be displayed at intervals such as one-half hour. The selected future time,  
20 i.e., 8:00 p.m., for the program listings displayed in area 46 is shown in a sub-area 43a of  
area 43. A brief program description of the program listing highlighted in area 46 by cursor  
48 is displayed in area 44. The current program being broadcast remains displayed in PIP  
window 42, and a banner 49 which identifies the current program by channel name, channel  
number, and program title is displayed between PIP window 42 and area 46 on a background  
25 having a different color or shade than cursor 48.

In FIG. 4, the CSPG screen format is shown. In the following description, this format  
is sometimes called the "THIS CHANNEL" guide. All the program listings for a selected  
channel, i.e., FOX Channel 7, are displayed in area 46, from the currently broadcast  
program into the future for a specified time period, e.g., 24 hours or until the end of the next  
30 day. Area 46 has a column for time and a column for program title; each line of area 46  
represents a separate program listing. The moving, real time images of the current television  
program are displayed in PIP window 42. If the cursor also highlights the current program,  
a brief program description of the current program is displayed in area 44. If the cursor  
highlights another program listing, as shown in FIG. 4, a brief program description of the  
35 highlighted program is displayed in area 44 and the current program is identified in banner  
49 by time and title.

In FIG. 5, the THSPG screen format is shown. In the following description, this  
format is sometimes called the "SORT" guide. The program listings for a selected theme

1 or subtheme, i.e., ALL MOVIES, are displayed in area 46, from the next broadcast program  
into the future for a specified time period, e.g., one week. Area 46 has a heading 46a that  
identifies the theme or subtheme, date, and day, i.e., ALL MOVIES DEC 12 MON, a  
column for title, a column for start time, and a column for channel name or number; each  
5 line of area 46 represents a separate program listing. The moving, real time images of the  
current television program are displayed in PIP window 42 and the current program is  
identified in banner 49 by channel name or number and title. A brief program description  
of the program highlighted by cursor 48 is displayed in area 44.

10 All four areas of background 40 are formatted in video processor 30. The memory  
space of video processor 30 corresponding to the area in which PIP window 42 appears on  
the screen is left blank; i.e., although overlaid on background area 40, PIP window 42 does  
not cover up any of the information of background area 40. By means of a pair of up/down  
arrows on viewer input device 28, the viewer can move a cursor 48 vertically to highlight  
15 the listing of one of the currently playing television programs displayed in area 46.  
Preferably, to reduce delays in displaying the program schedules, all the program listings for  
the particular screen format are stored in video processor 30, even though only a fraction of  
them are displayed at the same time. When the cursor reaches the top or bottom listing in  
area 46, microprocessor 24 recalls further program listings from video processor 30 for  
display on the screen of television receiver 20.

20 In all the formats, the moving, real time images of the current television program  
highlighted by cursor 48 are displayed in PIP window 42, the program description of the  
highlighted program is displayed in area 44, program listings of one type or another are  
displayed in area 46, and one or more prompts are displayed in banner area 43 as described  
in more detail below. The audio portion of the television program displayed in PIP window  
25 42 is reproduced by the sound system of monitor 20. The PIP display, the sound  
reproduction, and the program description in area 44 enable the viewer to assess better  
whether or not to watch the highlighted program. As the viewer moves cursor 48 vertically  
from program listing to program listing, the current television program displayed in window  
42 and the program description displayed in area 44 automatically change accordingly to  
30 match the highlighted program in area 46. As the cursor moves from one program listing  
to another, tuner 11 is set to the channel for the highlighted program listing so the program  
can be displayed in PIP window 42, microprocessor 24 recalls the program description for  
the highlighted listing from program schedule memory 22, and video processor 30 formats  
this program description so it can be displayed in area 44.

35 Preferably, two levels of detail are available for the program description. Normally,  
the first level detail of the program description is displayed in area 44 as described above.  
When more detail is desired, the viewer operates input device 28 to display a second level  
detail of the program description. There are two options for the display of the second level

1 detail. As one option, the second level detail can replace the first level detail in area 44.  
This has the advantage that the program listings can continue to be seen by the viewer while  
more detail about the program description is displayed. As the other option, the second level  
5 detail can replace the program listings in area 46. This has the advantage that more space  
is available to display the second level of detail than the first level.

Reference is made to FIGS. 6 to 14 for a description of the steps taken by a viewer  
to navigate about the preferred embodiment of the television program guide. Viewer input  
device 28 preferably takes the form of a hand-held remote infrared (IR) transmitter which  
communicates with an infrared receiver connected to microprocessor 24. As shown in FIG.  
10 6, the IR transmitter has a housing 50 on which a number of control buttons are mounted.  
A GUIDE/TV button 52, an INFO button 54, and a VCR PLUS+ button 56 are located  
above up and down arrow buttons 58 and 60. A row of buttons 62, 64, 66 and 68 which  
marked with the colors red (R), green (G), yellow (Y), and blue (B), respectively, underlie  
down arrow button 60. Red, green, yellow, and blue prompts are displayed in area 43 of  
15 the electronic guides. To select a prompt on the screen, the button of the IR transmitter  
having the corresponding color is pressed, i.e., to select the blue prompt on the screen, blue  
button 68 is pressed.

The screen formats and the links between the individual guides are designed with two  
objectives in mind--first, always to display the program the viewer was watching before  
20 entering the electronic guide and second, never to leave the electronic guide while navigating  
through it, until the viewer returns to the TV mode. As described below, the guides are  
linked to each other in a one way hierarchy that is accessed by on screen prompts color  
coded to the buttons on the remote control transmitter. At each level of the hierarchy, the  
viewer has the choice of returning to a backbone guide, or moving down to a guide at a  
25 lower level in the hierarchy. At the lowest level, the only choice is to return to the backbone  
guide. At each level, the viewer's choices are displayed on the screen by the prompts, so  
the need to use the buttons on viewer input device 28 to navigate through the guide is  
minimized.

As represented in FIG. 7 by a box 70, the viewer enters the electronic guide by  
30 pressing GUIDE/TV button 52 on the remote transmitter. As represented by a box 72, the  
so-called "NOW" guide is then displayed on the screen. This is the "backbone" of the  
electronic guide in that it is the starting point for entry into each other guide.

As represented by a box 74 in each of FIGS. 8 to 14, the viewer may cursor up and  
down the program listings in area 46 to select a particular program. As represented by a box  
35 76 in each of FIGS. 8 to 14, the viewer presses GUIDE/TV button 52 to return to the full  
screen TV mode and presses INFO button 54 to display the second level detail of the  
program information in area 44 or area 46.

1 In FIG. 7 a box 80 depicts the layout of the NOW guide, which is a version of the  
TISPG screen format. Area 43 has a blue "CHOICE" prompt and a banner that identifies  
the format as the "NOW" format and displays the date, day, and time. When the viewer  
presses blue button 68 on the remote transmitter (FIG. 6), as represented by a block 82, four  
5 prompting choices are presented to the viewer. As represented by a block 84 in FIG. 8,  
these prompting choices are displayed in an "ALL CHANNEL" guide.

Block 86 represents the "ALL CHANNEL" guide, which is identical to the "NOW"  
guide except for area 43. This is a transition guide in that it permits the viewer to enter  
other guides at a lower level of the hierarchy by following the displayed prompts. In the  
10 "ALL CHANNEL" guide, a red NOW prompt, a green CSPG prompt, a yellow NEXT  
prompt, and a blue SORT prompt are displayed. As represented by a box 88, in each of the  
guides of FIGS. 8 to 14, a return to the NOW guide of FIG. 7 occurs when the viewer  
presses red button 62 on the remote control transmitter.

As represented by a box 90 in FIG. 8 and a box 92 in FIG. 9, when green button 64  
15 is pressed from the ALL CHANNEL guide, a "THIS CHANNEL" guide in the CSPG format  
described above is displayed. A box 94 depicts the THIS CHANNEL guide, which is at the  
bottom of the hierarchy. So, only one prompt is displayed in area 43, namely the red NOW  
prompt, which permits the viewer to return to the NOW guide. Area 43 also displays the  
name and channel number of the specific channel, e.g. ABC, Channel 7.

As represented by a box 96 in FIG. 8 and a box 98 in FIG. 10, to display the  
20 "NEXT" guide, the viewer presses yellow button 66 on the remote control transmitter. The  
NEXT guide, which has the TISPG format, is depicted by a box 100. Initially, current  
programs are displayed in area 46, as in the NOW guide (FIG.2). Area 43 in the NEXT  
guide has in addition to the red NOW prompt, a green up arrow prompt, a blue down arrow  
25 prompt, and the time of the programs displayed in guide between the up and down arrows.  
Area 43 also displays the time at which the listed programs are broadcast, i.e., initially the  
current time. Each time the viewer presses blue button 68, the guide advances one half hour  
so the programs broadcast at a one-half hour later time are displayed, as represented by a  
box 104, and the time displayed in area 43 changes accordingly. Each time the viewer  
30 presses green button 64, the guide retreats one half hour so the programs broadcast at a one-  
half hour earlier time are displayed, as represented by a box 102 and the time displayed in  
area 43 changes accordingly. When buttons 64 and 66 are pressed to display future  
programs in area 46, banner 49 (FIG. 3) appears to identify the current real time television  
program being displayed in PIP window 42. The NEXT guide is at the bottom of the  
35 hierarchy so the only route of exit from this guide is the RED prompt to return to the NOW  
guide.

As represented by a box 105 in FIG. 8 and a box 106 in FIG. 11, a first level of  
"SORT" prompts is displayed when the viewer presses blue button 68 while in the ALL

1 CHANNEL guide. As depicted by a box 108 (FIG. 11), in addition to the red NOW  
prompt, there are a first level of SORT buttons that comprise a green MOVIES prompt, a  
yellow SPORTS prompt, and a blue OTHERS prompt in area 43. The ALL CHANNEL  
guide for the current time, i.e., NOW guide remains displayed in area 46. When the viewer  
5 presses green button 64, an "ALL MOVIES" guide is displayed in area 46, as represented  
by a box 109 in FIG. 11 and a box 112 in FIG. 12, and screen-1 of a second level, i.e.,  
subtheme, of movie SORT buttons is displayed in area 43, as represented graphically in a  
box 114 in FIG. 12. When the viewer presses blue button 68, the NOW guide is displayed  
in area 46, as represented by a box 130 in FIG. 14 and screen-2 of the first level, i.e., the  
10 SORT buttons, is displayed in area 43, as represented graphically in a box 111 in FIG. 11  
and a box 132 in FIG. 14.

In addition to the red NOW prompt, the screen-1, second level movie SORT buttons  
(FIG. 12) comprise a green ACTION prompt, a yellow COMEDY prompt and a blue  
OTHER prompt for calling up a screen-2 series of SORT buttons to permit selection of other  
15 subcategories of movies. In the ALL MOVIES guide, the sum of all the movies in all the  
subcategories are displayed. When the viewer presses green button 64, an ACTION  
MOVIES guide (not shown) is displayed in area 46. When the viewer presses yellow button  
66, a COMEDY MOVIES guide (not shown) is displayed in area 46. In each of these cases,  
only a RED prompt is displayed in area 43 because the electronic guide is at the bottom of  
20 the hierarchy and the only route the viewer can take is to return to the NOW guide (FIG. 7).  
When the viewer presses green button 64, an ACTION MOVIES guide (not shown) is  
displayed in area 46. When the viewer presses yellow button 66, a COMEDY MOVIES  
guide (not shown) is displayed in area 46. In each of these cases, only a RED prompt is  
displayed in area 43 because the electronic guide is at the bottom of the hierarchy and the  
25 only route the viewer can take is to return to the NOW guide (FIG. 7). When the viewer  
presses blue button 68, as represented by a box 120 in FIG. 12 and a box 122 in FIG. 13,  
the ALL MOVIES guide remains displayed in area 46 and the screen-2 series of second level  
movie SORT buttons is displayed in area 43. As represented graphically by a box 124, the  
screen-2 series of SORT buttons for the second movie level comprise, in addition to the red  
30 NOW prompt, a green DRAMA prompt, a yellow HORROR prompt, and a blue ALL  
OTHER prompt. When the viewer presses green button 64, a DRAMA MOVIES guide (not  
shown) is displayed in area 46. When the viewer presses yellow button 66, a HORROR  
MOVIES guide (not shown) is displayed in area 46. When the viewer presses blue button 68,  
a ALL OTHER MOVIES guide (not shown) is displayed in area 46. In each of these cases,  
35 only a RED prompt is displayed in area 43 because the electronic guide is at the bottom of  
the hierarchy and the only route the viewer can take is to return to the NOW guide (FIG. 7).

The reason for multiple screens of prompts in the movie theme guide is to provide the  
number of prompts in area 43 to display all the subcategories of movies. Instead of an ALL

1 OTHER movie prompt, a screen-3 series of second level movie SORT buttons could be displayed if more movie subcategories are desired. This pattern of screen could be extended as far as necessary to satisfy the need for subcategories.

5 As represented in FIGS. 11 and 14, when the viewer presses blue prompt button 68 in the first level of SORT buttons, a screen-2 of first level SORT buttons is displayed in area 43 and the NOW guide remains displayed in area 46. As depicted graphically by box 132, in addition to the red NOW prompt, the screen-2 SORT buttons comprise a green CHILD prompt, a yellow SPECIAL prompt, and a blue SERIES prompt. When the viewer presses green button 64, an ALL CHILDREN's guide (not shown) is displayed in area 46 as represented by a box 134. When the viewer presses yellow button 66, an ALL SPECIAL guide (not shown) is displayed in area 46 as represented by a box 136. When the viewer presses blue button 68, an ALL SERIES guide (not shown) is displayed in area 46 as represented by a box 138. In each of these cases, only a RED prompt is displayed in area 43 because the electronic guide is at the bottom of the hierarchy and the only route the viewer can take is to return to the NOW guide (FIG. 7).

15 As represented by block 110 in FIG. 11, when the viewer presses yellow prompt button 66, an ALL SPORTS guide is displayed in area 46. Alternatively, there could be multiple levels and screens of sports SORT buttons in analogous fashion to the hierarchy of the movie prompts and guides. (Such a hierarchy could also be provided for any of the other categories of the SORT guide.)

20 FIG. 15 shows the hierarchy of prompts and guides described in connection with FIGS. 7 to 14, beginning with the entry into the electronic guide by pressing button 52 on the IR transmitter. The particular guide displayed on the screen in area 46 when a prompt is selected is designated in parentheses, e.g. the NOW guide is displayed when the CHOICE prompt is selected. In each case the guide remains unchanged from the preceding guide in the hierarchy. If no guide is designated in parentheses, the guide displayed when a prompt is selected is the same as the prompt, e.g., the THIS CHANNEL guide is displayed when the CSPG prompt is selected and the ALL MOVIES guide is displayed when the ALL MOVIES prompt is selected. Note that a broken line 150 depicts the levels of the SORT hierarchy--the first level lies above line 150 and the second level lies below line 150. At any level of the hierarchy, the viewer has two choices for navigating through the guide--select the RED prompt to return to the NOW guide or select one of the GREEN, YELLOW, or BLUE prompts to move to the following level. As stated above, the hierarchy of guides and prompts can be expanded to provide more themes by changing the ALL SERIES prompt to a OTHERS SCREEN-3 prompt and to provide more subthemes of movies by changing the ALL OTHER MOVIES prompt to a ALL MOVIES SCREEN-3 prompt, etc. Similarly, the hierarchy of guides and prompts can be expanded to provide subthemes for other themes, e.g., SPORTS, in the same manner as illustrated for MOVIES.

1 A feature of the invention that facilitates viewer orientation in the electronic guide is  
to color code PIP window 42 and program description area 44 consistently with the titles of  
the programs to which the information in these areas relate. Specifically, as illustrated in  
FIG. 16, in the NOW guide (FIG. 2) PIP window 42 has a border 152 that is the same color,  
5 e.g., dark blue, as the background of area 44 and cursor 48, which forms a color bar.  
Further, as illustrated in FIG. 17, in the NEXT guide (FIG. 3), as well as the THIS  
CHANNEL guide (FIG. 4) and the SORT guide (FIG. 5), where the description in area 44  
relates to a different program than that displayed in PIP window 42, the background of area  
44 is a different color or shade than border 152. The latter guides all have a cursor (color  
10 bar) 48 that identifies the title of the program described in area 44. For example, the  
background of area 44 and cursor 48 are light blue to signal to the viewer that the title  
highlighted by cursor 48 identifies the program described in area 44, while border 152 and  
banner 49 remain dark blue to signal that the title in banner 49 identifies the program in PIP  
window 42.

15 If the television receiver does not have a PIP chip, the described screen formats can  
be simulated by rearranging the prompts and the guide and program description information  
and overlaying such information over the real time moving images of the current television  
program. In contrast to the PIP format, this results in loss of part of the picture of the  
television program. But, the remainder of the picture, which is the center part of the image,  
20 together with the sound portion thereof generally conveys most of the essential information  
of the television program. In FIG. 18, such a simulation has a truncated real time picture  
area 160, instead of PIP window 42, a message prompting area 162, instead of area 43, a  
program description area 164, instead of area 44, and an electronic program guide area 166,  
instead of area 46. Area 164 is located across the full width at the top of the screen area and  
preferably does not include the program title. Prompt area is at the bottom of the screen area  
25 and is otherwise like the PIP screen format described above. Guide area 166 is between  
areas 160 and 162 and preferably has several fewer lines of program listings than the PIP  
screen format. The size of the picture in area 160 is the same as the picture when the  
electronic guide is not operating, but the top and bottom parts of the picture are cut off by  
areas 162, 164, and 166. To implement this embodiment of the invention, the following  
30 changes in the television receiver of FIG. 1 are made:

- Microprocessor 24 is configured to format the screen as shown in FIG. 18, leaving  
blank area 160.
- PIP chip 19 is replaced by a video mixer.

35 FIG. 19 illustrates another way to navigate through the electronic guides described  
above. The abscissa represents time and the ordinate represents channel. As represented by  
a line 170, starting in the NOW guide, the viewer moves the cursor from channel to channel  
and current programs are displayed in the PIP window. As represented by a line 172, the  
viewer selects the THIS CHANNEL guide and moves the cursor from time slot to time slot.

1 The program on the channel to which the tuner was last set in the NOW guide remains  
displayed in PIP window 42 and the description of the program on said channel at the time  
slot highlighted by the cursor is displayed in area 44. As represented by a line 174, the viewer  
selects the NEXT guide and moves the cursor from channel to channel. The program on the  
5 channel to which the tuner was last set in the NOW guide remains displayed in PIP window  
42 and the description of the program on the channel highlighted by the cursor at the time  
slot last highlighted in the NEXT guide is displayed in area 44. As represented by a line  
176, the viewer again selects the THIS CHANNEL guide and moves the cursor from time  
slot to time slot. The program on the channel to which the tuner was last set in the NOW  
10 guide remains displayed in PIP window 42 and the description of the program on the channel  
last highlighted in the NEXT guide at the time slot currently highlighted by the cursor is  
displayed in area 44. As represented by a line 178, the viewer selects the NEXT guide and  
moves the cursor from channel to channel. The program on the channel to which the tuner  
was last set in the NOW guide remains displayed in PIP window 42 and the description of  
15 the program on the channel highlighted by the cursor at the time slot last highlighted in the  
NEXT guide is displayed in area 44. As represented by a line 180, the viewer again selects  
the THIS CHANNEL guide and moves the cursor from time slot to time slot. The program  
on the channel to which the tuner was last set in the NOW guide remains displayed in PIP  
window 42 and the description of the program on the channel last highlighted in the NEXT  
20 guide at the time slot currently highlighted by the cursor is displayed in area 44. In this  
manner the viewer can navigate either into the future or toward the current time and across  
channels to determine the television program schedule.

In summary, rather than navigating through a two dimensional (time/channel) grid  
guide, the technique described in connection with FIG. 19 isolates the two dimensions, i.e.,  
25 time and channel, and displays all the channels at any time selected by the viewer or all the  
times on any channel selected by the viewer.

Another feature that is particularly useful in the NOW guide calls for the temporary  
selective elimination of program listings by viewer command. Thus, in the NOW guide  
when the viewer is not interested in a displayed program, the viewer can move the cursor  
30 to the unwanted program and press a dedicated DELETE button (not shown) on the IR  
transmitter or an existing function button such as ENTER. The microprocessor is configured  
to delete the listing for the program from the NOW guide and to block the tuner from being  
set to the channel that carries the unwanted program. As a result, the viewer can graze  
through the programs of interest much more quickly. When the unwanted program is  
35 finished, the microprocessor unblocks the tuner from being set to the channel and displays  
the next program on the channel in the NOW guide. If desired, the microprocessor can be  
configured to keep the tuner blockage in effect in the THIS CHANNEL guide and the normal  
television mode.

1           A variation of the above feature is to configure the microprocessor to display the  
unwanted programs marked with the cursor in a manner that distinguishes from the wanted  
programs, e.g., in a half gray scale. When the viewer moves the cursor to the unwanted  
program and presses the DELETE button, the microprocessor is configured to display the  
5           unwanted program in the half gray scale, to prevent the cursor from highlighting the  
unwanted program, and to block the tuner from being set to the channel that carries the  
unwanted program. Since the unwanted program is still visible, the viewer can change his  
or her mind before the end of the unwanted program. Thus, the microprocessor is configured  
to return the program display to normal, to permit the cursor to highlight the program, and  
10           to unblock the tuner, when a special cursor control sequence is executed. For example, the  
sequence could be to move the cursor to the program listing immediately above the unwanted  
program or series of programs, press the right arrow button to permit movement of the  
cursor to the unwanted program or programs, highlight with the cursor the unwanted  
program that it is desired to restore, and then press the DELETE button.

15           As described in more detail below, in program schedule memory 22, the program  
listings are coded by day of the week, time of day, and channel so that they can be accessed  
by microprocessor 24 when necessary to supply program schedule information to video  
processor 30 to compose the program listings and the program descriptions. Microprocessor  
24 has a real time-clock (not shown), the time of which is compared with the time of day and  
20           day of the week codes to select the program listings for the TISPG mode. The functional  
storage areas of cursor position register 32 are mapped to the storage areas of video  
processor 30 where the program schedule is formatted for display on background area 40 so  
cursor position register 32 points to the area of the screen, and thus the particular program,  
that is highlighted by cursor 48. By comparing the cursor position in register 32 with the  
25           channel corresponding to the highlighted area of video processor 30, the channel of the  
highlighted program is derived and coupled to microprocessor 24. Microprocessor 24 then  
sets tuner 11 to this channel.

          In TISPG operation, microprocessor 24 recalls the appropriate program listings from  
memory 22 and transmits them to video processor 30 where the program listings of area 46  
30           and the program description of the highlighted program in area 44 are composed. At the  
same time, microprocessor 24 operates switch 18 so the output of tuner 11 is directly  
connected to the one input of PIP chip 19 and switches PIP chip 19 into a PIP mode, such  
that the input from tuner 11 is displayed in the PIP window and the program schedule from  
video processor 30 is displayed in the background. Microprocessor 24 senses the channel  
35           to which the tuner is set when the TISPG mode is entered, and initially positions cursor 48  
at the program listing broadcast on this channel. As the viewer moves the up/down arrows  
of the cursor control key set, tuner 11 is reset accordingly and new program schedule  
information is fed through microprocessor 24 to video processor 30 to recompose the

1 program listings so cursor 48 remains visible and the program description remains current.  
The described TISPG mode facilitates channel grazing by the viewer. When the viewer finds  
the video program he or she wishes to watch, the viewer leaves the TISPG mode. As a  
result, microprocessor 24 switches PIP chip 19 out of the PIP mode, such that the video  
5 program inputted from tuner 11 is displayed full screen.

If the viewer wishes to record the program highlighted in the TISPG mode, the viewer  
commands microprocessor 24 to turn on VCR 17 for recording.

If the viewer wishes to play a video tape cassette on VCR 17, the viewer commands  
microprocessor 24 to turn on VCR for playback and to operate switch 18 for connection of  
10 the output of VCR 17 through PIP chip 19 to television receiver 20.

The television receiver of FIG. 1 can also be used with the format of FIGS. 3, 4, or  
5 in an extension of the CSPG mode to display previews of future programming as video  
clips. The video clips are stored on a video tape cassette that is loaded into VCR 17. The  
addresses of the video clips on the tape of the video cassette are stored in program schedule  
memory 22 as part of the data base. These addresses are linked to the respective future  
15 program listings in the data base so that a video clip can be accessed on the tape when a  
program listing is designated in the database. When the viewer presses the CSPG mode key,  
in addition to the operation as described in connection with FIG. 4, microprocessor 24 places  
the current program title in banner 49, as illustrated in FIG. 4. So long as cursor 48  
20 highlights the title of the current program, the CSPG mode operates as described above.  
When the viewer moves cursor 48 vertically by operating the cursor control key set on  
viewer input device 28 to highlight the title of a future program displayed in area 46, the  
address of the video clip of the highlighted program listing is retrieved by microprocessor  
24 from program schedule memory 22 and transmitted to VCR 17. The video clip is  
25 retrieved from the tape in VCR 17 and coupled through switch 18 and PIP chip 19 to  
television receiver 20 for display in PIP window 42. The video clips on the tape of the  
videocassette are indexed and accessed in the manner described in co-pending application  
Serial No. 08/176,852, filed on December 30, 1993 and entitled ENHANCING  
OPERATIONS OF VIDEOTAPE CASSETTE PLAYERS, the disclosure of which is  
30 incorporated fully herein by reference.

An extension of the TISPG mode illustrated in FIG. 2 also permits display of video  
clips of future programming. Specifically, in the time-channel grid format microprocessor  
24 also controls cursor 48 responsive to the cursor key set of viewer input device 28, which  
in this embodiment includes a horizontal cursor control, such as a pair of right/left arrows.  
35 As described above, the address for the highlighted future program listing is retrieved by  
microprocessor 24 from program schedule memory 22 and transmitted to VCR 17 to access  
the corresponding video clip, which is displayed in PIP window 42.

1           Another embodiment in which video clips can be displayed in PIP window 42 is  
illustrated in FIG. 5. In addition to banner area 43 and program description area 44,  
background area 40 has program schedule area 46, in which program listings are displayed  
by theme such as movies, sports, current events, etc. Area 46 contains a column for  
5           program start time, a column for program channel, and a column for program title. To  
implement this embodiment, the program listings of the data base stored in program schedule  
memory 22 are also coded by theme so that they can be accessed by microprocessor 24 in  
response to the viewer selection of themes from an on-screen menu in well known fashion.  
As described in connection with the extended TISPG and CSPG modes described above,  
10           when the title of a future program listing is highlighted by cursor 48, the corresponding  
moving image video clip is displayed in PIP window 42. If desired, a video disc player  
could be substituted for VCR 17 to provide the video clips to switch 18 in order to speed up  
the access time to the moving images displayed in PIP window 42.

          In another embodiment, program related information (PRI) is displayed in background  
15           area 40 while the real time television program to which the PRI relates is displayed in PIP  
window 42. The PRI is transmitted in the vertical blanking interval (VBI) of the television  
signal of the channel carrying the television program to which the PRI relates,  
contemporaneously with this television program. As illustrated in FIG. 19, to implement this  
embodiment a VBI decoder 53 is connected between the output of tuner 11 and  
20           microprocessor 24 and a PRI memory 57 is connected to microprocessor 24 as shown in  
FIG. 20. The PRI is stripped from the VBI of the television signal by decoder 53 and stored  
in memory 57 by microprocessor 24.

          In operation, when the viewer presses a PRI key on viewer input device 28 the real  
time television program of the channel to which tuner 11 is set is displayed in PIP window  
25           42. In addition to banner area 43 and program description area 44, background area 40 has  
a PRI area 59 in which different types of PRI are displayed. In FIG. 21 the real time  
television program is a cooking demonstration by Julia Child and the PRI displayed in area  
59 is a recipe made in the course of the demonstration. Other information about the program  
is displayed in area 44. Another example for the real time television program could be a  
30           commercial for Lexus automobiles and the PRI displayed in area 59 could be a test drive  
offer for Lexus. The name and address of the local Lexus dealer in the geographic area of  
the viewer might be displayed in area 44.

          Another version of the NOW guide is shown in FIG. 33. This version is the same as  
the guide of FIG. 2 except for the prompts in area 43, which are SORT NOW, SERVICE,  
35           CABLE, and LATER. The SORT NOW prompt permits the viewer to sort by theme, and  
thus reduce the number of displayed programs, by "filtering out" all the programs that do  
not meet a selected theme. The SERVICE prompt permits the viewer to enter a mode in  
which a number of various items of information such as news, weather, sports scores, or

1 financial data can be selected for display. The CABLE prompt permits the viewer to obtain  
information unique to the particular cable system such as pay per view offerings or special  
promotions on premium channel packages. The LATER prompt permits the viewer to  
advance to the screen shown in FIG. 8 and continue to navigate as described in connection  
5 with FIGS. 8 to 15.

In FIG. 34, the prompts in area 43 are NOW and SELECT. The real time images of  
the last program highlighted by cursor 48 in area 46 of the NOW guide are displayed in PIP  
window 42, the program description of this program is displayed in area 44, and the title and  
channel of the program are displayed in banner 49. A list of program themes is displayed  
10 in area 46, instead of program listings. Any of the themes can be highlighted by cursor 48.

In FIG. 35, the NOW prompt and a selected theme are displayed in area 43. A list  
of the current programs meeting the selected theme identified in area 43 is displayed in area  
46. As in the NOW guide of FIG. 2, when the viewer moves cursor 48 from program to  
program in area 46, the real time images of the highlighted program are displayed in PIP  
15 window 42 and the program description is displayed in area 44. By thus filtering out the  
programs meeting the other, nonselected themes, the list of displayed current programs can  
be sharply reduced. This facilitates channel grazing the programs of interest to the viewer  
in PIP window 42 because the viewer has fewer programs to highlight with cursor 48.

Reference is made to FIGS. 36 to 39 for a description of the steps taken by the viewer  
20 to navigate about the television program guide of the preferred embodiment described in  
connection with FIGS. 6 to 14 modified to incorporate the screens of FIGS. 32 to 34.  
Microprocessor 24 is programmed to carry out the described operations.

FIG. 36 is the same as FIG. 7 except that the flow is to FIG. 37, instead of FIG. 8.  
Thus, when the viewer enters the electronic guide by pressing GUIDE/TV button 52 on the  
25 remote transmitter, the NOW guide is displayed on the screen. When the viewer presses red  
button 68 on the remote transmitter, four prompting choices are presented to the viewer. As  
represented by a block 400 in FIG. 37, these prompting choices are displayed in an "ALL  
CHANNEL" guide.

Block 401 represents an "ALL CHANNEL" guide, which is identical to the "NOW"  
30 guide except for area 43. This is a transition guide in that it permits the viewer to enter the  
other modes described above in connection with FIG. 33. In this "ALL CHANNEL" guide,  
a blue SORT NOW prompt, a green SERVICE prompt, a yellow CABLE prompt, and a red  
LATER prompt are displayed. In this guide, the viewer cannot return directly to the NOW  
guide. To return to the NOW guide, the viewer must first return to the TV mode by  
35 pressing button 52.

As represented by a box 402 in FIG. 37 and a box 404 in FIG. 38, when blue button  
62 is pressed from this ALL CHANNEL guide, the list of themes is displayed. In FIG 38,  
as represented by a block 405 a blue NOW prompt and a red SELECT prompt are displayed.

1 When the viewer presses blue button 62, the NOW guide is displayed in area 46, as  
represented graphically by a box 406. To select a theme, the viewer, operates arrow buttons  
58 and 60 to highlight the selected theme and then presses red button 68, as represented by  
box 68, to select the theme as represented by a box 408. Thereupon, the NOW guide  
5 filtered by theme is displayed in area 46, as represented by a box 410. Instead of a single  
theme, microprocessor 24 could be programmed to select two or more themes, in which case  
the current programs meeting all the selected themes would be displayed.

FIG. 39 shows the hierarchy of prompts and guides described in connection with  
FIGS. 35 to 37. The hierarch shown in FIG. 15 is incorporated into the hierarchy of FIG.  
10 39 as illustrated.

### **Data Base Operations**

In the preferred embodiment, the system contains a data base used to store all the  
information needed to create the program guides and to carry out requests, such as  
requests to record specific future programs. The data base is stored in program schedule  
15 memory 22 and is directly accessible by the system microprocessor 24. The data base is  
divided into a static area 300 and a dynamic area 301. The static area contains several  
pre-allocated tables used to store, locate and search data for the creation of program  
guides. The pre-allocated tables are placed at fixed, unchanging addresses in the static  
area to facilitate rapid searching by the microprocessor. The dynamic area is used to  
20 store actual television program schedule data. Since the system always contains data for  
the current day(today) and the following day(tomorrow), the dynamic area is updated as  
new data is received.

FIG. 22 depicts the program schedule memory data base. Static area 300 contains  
the call letter map, the pre-established time list, the channel map, the control array, the  
25 memory map, the source map, the record queue, and pointers to the extended theme show  
lists. These structures will be described in greater detail below. Dynamic area 301 is  
used to store television program schedule data. This data takes the form of show  
information packages (SIPs) and extended theme show list entries. These structures are  
also described more fully below.

### **Data Transmission**

Television program data is received in download packets. The download packets  
are sent over the VBI and received by microprocessor 24 in the manner described in FIG.  
20. A download packet contains television program schedule information along with  
routing data that enables the system to determine how to store the information in memory.

35 FIG. 23 illustrates a download packet. The packet begins with a packet header  
containing packet ID number 302 used to distinguish this packet from other packets. The  
packet header also contains number of bytes 303 and number of blocks 304. These  
values are used to determine the size of the packet.

1           The packet header is followed by the show information package (SIP) header.  
There is a show information package header for each show information package in the  
packet. The SIP header contains: guide number 305 which is the internal channel number  
of the data in the show information package; source ID 306 used to determine the source  
5           of the data in the show information package; and time slot 307 used to designate the time  
and day of the data in the show information package. A show information package 308  
follows the SIP header.

          Upon receipt, the system microprocessor extracts a show information package from  
the download packet and temporarily stores it in program schedule memory. The show  
10           information package contains a date field that is used to determine if the data is for the  
current day(today) or the next day(tomorrow).  
If the package falls within this two day window the system determines if the data is  
duplicative of existing data. The show information package contains a version number  
used to determine if the data is new or if it already exists in memory. If the data is new  
15           then it is stored and the address of the show information package is placed in the  
appropriate pointer in the pre-established time list. The pre-established time list will be  
explained more fully below.

          If the show information package is outside of the current two-day window (today  
and tomorrow)and the show information package contains programs that have theme  
20           information, those programs with theme information are pulled out of the show  
information package and placed in the appropriate extended theme show list. The  
extended theme show list is described more fully below. If the show information package  
is outside of the current two-day window and does not contain theme information, or if  
the show information package is duplicative of one that is already stored the entire show  
25           information package is discarded.

          The system uses a memory bit map in order to keep track of which parts of the  
program schedule memory are currently holding program data and which parts of the  
program schedule memory are free to store new program data. The memory bit map  
divides the memory into 32 byte blocks. Each block is represented by a bit in the  
30           memory bit map.

          The memory bit map is depicted in FIG. 24. Each bit in the map 310 represents a  
32 byte block of memory. A "1" in the bit position 311 indicates that program data is  
stored in that block. A "0" in the position 312 indicates that the block is free. When  
new data arrives in the system, microprocessor 24 searches through the memory bit map  
35           to locate a sufficient number of adjacent free positions in which to store data. When the  
positions are located, microprocessor 24 stores the data and then changes those numbers  
in the memory bit map from "0" to "1" to indicate that those memory locations are  
occupied.

1 For example, referencing FIG. 24, if data is received that requires ten blocks of storage the system will scan the memory map and store the data in the space represented by bits 0-7 in row 3 and bits 0-1 in row 4. These bits will then be set to "1" in the memory bit map.

5 The system will also periodically re-order the memory so that free space is grouped contiguously. For example, referencing FIG. 24, the data starting in the block represented by bit 2 in row 0 and ending in the block represented by bit 1 in row 1 would be slid over to the block represented by bit 3 in row 0. This will remove the "0" gap in row zero. This process is repeated throughout the memory map so that all free space is  
10 grouped together at the end of memory.

The system also contains procedures for reducing the amount of new data that is stored if there is only limited memory space available. By scanning the memory map the system can determine if the memory is becoming full. When this happens the system may discard some new data such as program descriptions in order to maximize the  
15 number of individual shows that can be stored in the available memory.

#### Data Structures

Data in the program schedule memory is stored in data structures that enable the system to interpret the data. Several of the data structures are of fixed length and reside in the static area 300. These data structures reside at fixed addresses and therefore can  
20 be accessed by the microprocessor without further memory calculations. Other data structures are of variable length and reside in the dynamic area 301. The fixed data structures include: the pre-established time list, the channel map, the control array, the call letter map, the memory map, the source map and the record queue. The variable data structures include: show information packages and extended theme show lists.

25 The pre-established time list is used to locate television program information for each channel in the system. The pre-established time list only references program information that will be broadcast on the current day (today) or on the next day (tomorrow). The pre-established time list references data through the use of pointers which are pieces of data that contain addresses of desired data items in dynamic area 301.

30 FIG. 25 illustrates the pre-established time list. The pre-established time list contains a set of twelve pointers 313 for each channel in the system. Each pointer corresponds to a show information package that contains data for a four hour block of television programming. For example, in FIG. 25, the pointer E1 corresponds to program data on channel 1 from four p.m. to eight p.m. Twelve pointers represent the  
35 sum of 24 hours of programming information for the current day and 24 hours of program information for the next day.

Pointers A2 through L2 are used to represent the program data associated with channel 2 in the system. Each pointer contains an address of a show information package

1 of variable length containing actual television program data. When specific data is  
needed, the system first looks in the pre-established time list to secure the pointer, then  
uses the address found in that location to determine where the data is actually stored. For  
example if data for the channel 2 in the system is needed for a television program  
5 between eight p.m. and twelve midnight the system will use the address in pointer F2 to  
determine the location of the show information package containing the data.

Show information packages are variable length data structures that contain actual  
television program schedule data. Each show information package contains data for a  
four hour block of television programming for a specific channel. The show information  
10 package length is variable because the number of shows in each four hour block will  
depend on the duration of the individual shows.

FIG. 26 depicts a show information package. A show information package  
contains the following: amount of memory - used to determine how much space was used  
to store the show information package and therefore, how much space is freed up after  
15 the show information package is no longer needed; control date - used to determine  
whether the data in a specific show information package is for the current day, the next  
day, or outside of the current two-day window; and version number used to specify the  
specific version of the program data.

Following these three fields is specific data for each show that fits within the four-  
20 hour time block. For a given show, represented by block 314, the following fields are  
present in the show information package: multiple show flag field - used to determine if  
this show is the last show within the package, or if there are other shows following to be  
processed; start time field - an offset from the start time of the four-hour block, this  
offset is added to the time of the four-hour block to determine the start time of the show;  
25 duration field - specifies the air time for the particular show, this field is used if the  
show is selected for recording to determine the length of the recording; theme field -  
contains information on the type of show; for example, the show may be a sporting event,  
a news program, or a movie; CC field - determines whether or not the show is closed  
captioned; stereo field - determines whether or not the show is broadcast in stereo; add-  
30 ons field - is a field left for expansion, this field will contain more information about the  
show as that information becomes standard in the art.

Following these fields are fields representing program title, primary description - a  
short description of the program, secondary description - a longer description of the  
program and VCR+ PLUSCODE. Each of these items are represented by two fields,  
35 one containing the length of a specific item, such as title length, and one containing the  
item itself, such as title.

Following this information is an end-of-show field. The end-of-show field is used  
to indicate that the information for that particular show is finished. A show information

1 package may contain information for one or more shows depending on how many shows  
are broadcast within the four hour block. The presence of multiple shows is represented  
by 315 and 316.

5 A show information package is structured so as to provide several unique features  
for storing data. The title length, primary description length, secondary description  
length and VCR+ PLUSCODE length fields can be expanded for values that are beyond  
the maximum value that can be stored within one byte. For example, referring to FIG.  
27, if the secondary description length equals a number greater than the maximum  
number that can be stored within one byte, the length byte is set to this maximum value.  
10 The system then assumes that the following byte also represents length and adds the two  
values to determine the total length of the secondary description. In this way, a show  
information package can dynamically allocate space to accommodate longer descriptions  
or longer titles.

15 The end-of-show field allows for the inclusion of data in the show information  
package that is not read by the current version of the system. As shown again in FIG.  
27, following the VCR+ PLUSCODE field, there are two fields of unspecified data.  
This is data which may be read by future versions of the system but is currently not  
processed. When processing show information package data the system expect an end-of-  
show field following the VCR+ PLUSCODE field. If an end-of show field is not found  
20 the system will discard the data and look at the next byte. The system will not begin  
processing data for a new show until an end-of-show field is found. This feature allows  
the system to access the same data as a potential future version which may process data  
beyond title, description and VCR+ PLUSCODE. For example a future version might  
also include a list of the actors in a particular show. This information would be added to  
25 the download data after the VCR+ PLUSCODE. Older versions which did not include  
the feature of displaying the new data would discard it without causing an error in the  
download process.

30 Television programming information for shows that contain a theme (movie,  
sporting event, etc.) but have a start time beyond the current two day window (i.e. shows  
that will air after tomorrow) are stored in an extended theme show list. An extended  
theme show list is a linked list of television shows. Each show in the list contains data  
for a single program. The system contains an extended theme show list for each of the  
different theme categories (sports, movies, children's programming, specials, info).

35 An extended theme show list is depicted in FIG. 28. The address 317 of the first  
show in the list 318 is stored in static area 300. Show 318 is stored in dynamic area 301  
and contains a pointer 319 to the next show that will play. This scheme is repeated for  
all shows in the list. The pointer field in the last show contains the value "NULL" to  
indicate that there are no other shows in the list. Because each show in the list is linked

1 to the next show, an entire list can be traversed by ascertaining the address of the first show in the list.

Each show contains the same field format as show information package 314 with the exception that the channel ID is stored for each show. The conventions applying to show information package 314 that allow for extending the length fields and for additional data before the end-of-show flag also apply in the extended theme show list.

The program schedule memory also contains a channel map located in static memory 300. The channel map links the channel number of television program information with the internal guide channel. For example, in FIG. 29, channel 7 is assigned to internal channel 1 and channel 11 is assigned to internal channel 3. The channel map is referenced in order to identify a channel number when creating a program guide display. The source channel number is also used to tune to a specific channel upon operator selection.

The program schedule memory also contains a preallocated control array located in static memory 300. The control array is used by the system to track channels which have been inhibited for display by the operator. The control array is depicted in FIG. 30. For each channel, there is a display field 320 which is set to the "1" if the channel is to be displayed and set to the "0" if the channel is to be inhibited. Referring to FIG. 30, channels 0, 1, 3, and 4 will be displayed in a program guide while channel 2 will be inhibited. There is also a field for each channel for additional "add-on" information. This field allows for the addition of other operator controlled functions in future versions of the system such as a parental lock-out facility.

The program schedule memory also contains a call letter map located in static memory 300. The call letter map links the call letters corresponding to the source channel with the internal guide channel. For example, in FIG. 31, the call letters KABC are linked to internal channel 0 and WWOR is linked to internal channel 1. The call letter map is referenced in order to identify source channel call letters when creating a program guide display.

The program schedule memory also contains a source map located in static memory 300. The source map links the particular source of a television station with the internal guide number. Several stations may have the same source. For example the source "Home Box Office" may be associated with HBO, HBO2, HBO3, etc.. In an alternative embodiment the system could be configured to reorder program guide channels based on the source information. For example, the system could be directed to place all channels coming from the source "Home Box Office" at the beginning of a program guide.

1 Operator requests for recording future programs are stored in the record queue.  
The record queue is a fixed length table (20 entries) located in static area 300. The record  
queue is depicted in FIG. 32.

5 Each show in the queue contains a value representing the channel that the show  
will air on and a value representing the start time of the show. The record queue is  
structured so that programs are in time sequence order. That is, the first item in the list  
will be broadcast earlier than any of the other items, and so on. This allows the system  
to easily find the next program to be recorded.

#### Data Base Processing

10 Interaction between the data structures and the system is illustrated through the  
following examples of system operation.

A. The operator, using viewer input device 28 requests a time specific program  
guide (TISPG), the current time is 7 p.m.

15 When the user requests a TISPG for information pertaining to television shows  
that are currently being broadcast, the system first reads the current time (7 p.m.) from  
the microprocessor clock. The system then determines the pointers that correspond to  
current time in the pre-established time list, FIG. 25. Since the current time is 7 p.m.  
the system will look to the fifth pointer (this pointer corresponds to the data from 4 p.m.  
to 8 p.m.) for each channel: Channel 1 - E1, Channel 2 - E2, Channel 3 - E3, . . . ,  
20 Channel n - En.

For each pointer the system accesses the associated show information package,  
FIG. 26. The system adds the start time of the four hour block (4 p.m.) to the time  
offset in each show in the show information package to determine the show that is  
currently airing on that channel. Information for the show is then extracted from the  
25 show information package. The extracted information includes title, primary description,  
secondary description and VCR+ PLUSCODE.

Each internal channel number is also used to index into the channel map, FIG. 29.  
Specifically, the channel number is used to pull out the specific source channel number  
for display in the guide: Channel 1 - 7, Channel 2 - 6, Channel 3 - 11, . . . , Channel n -  
30 172. The channel number is also used to index into the call letter map, FIG. 31.  
Specifically, the channel number is used to pull out the station identification call letters  
for display in the guide: Channel 1 - KABC, Channel 2 - WWOR, . . . , Channel n -  
KTVR. All of the information from the show information package, the channel map and  
the call letter map is used to create formatted text lines for display in the guide.

35 B. The operator, using viewer input device 28 requests a channel specific program  
guide (CSPG), the current channel being viewed is channel 6, the current time is 3 p.m.

When the user requests a CSPG for information pertaining to television shows that  
are airing or will be broadcast on a specific channel (channel 6) at a specific time (3 p.m.)

1 the system determines the internal channel corresponding to the displayed channel by reading  
a system variable. For this example the internal channel is channel 2. The system then  
reads the current time (3 p.m.) from the microprocessor clock. The system determines the  
pointer that corresponds to current time for the selected internal channel in the pre-  
5 established time list, FIG. 25. Since the current time is 3 p.m. and the selected internal  
channel is channel 2 the system will look to the fourth pointer (this pointer corresponds to the  
data from 12 noon to 4 p.m.) in the second set of pointers. This pointer is D2, FIG. 25.

The system then accesses the associated show information package, FIG. 26, for  
pointer D2. The system adds the start time of the four hour block (12 noon) to the time  
10 offset in each show in the show information package to determine the show that is currently  
airing. Information for the show is then extracted from the show information package. The  
extracted information includes title, primary description, secondary description and VCR+  
PLUSCODE. The system extracts data for all shows in the show information package pointed  
to by D2 that occur after the selected show. Information is then extracted for all shows in  
15 show information packages pointed to by pointers E2 - L2.

The internal channel number is also used to index into the channel map, FIG. 29.  
Specifically, the channel number is used to pull out the specific channel ID, channel 6, for  
display in the guide. The channel number is also used to index into the call letter map, FIG.  
31. Specifically, the channel number is used to pull out the station identification call letters,  
20 WWOR, for display in the guide. All of the information from the show information  
package, the channel map and the call letter map is used to create formatted text lines for  
display in the guide.

C. The operator, using viewer input device 28 requests a theme specific program  
guide (THSPG), the selected theme is "MOVIE", the current time is 10:30 a.m.

25 When the user requests a THSPG for information pertaining to television shows  
having a specific theme (MOVIE) that are airing or will be broadcast, the system first reads  
the current time (10:30 a.m.) from the microprocessor clock. The system then determines  
the pointers that correspond to current time in the pre-established time list, FIG. 25. Since  
the current time is 10:30 a.m. the system will look to the third pointer (this pointer  
30 corresponds to the data from 8 a.m. to 12 noon) for each channel: Channel 1 - C1, Channel  
2 - C2, Channel 3 - C3, . . ., Channel n - Cn.

For each pointer the system accesses the associated show information package, FIG.  
26. The system adds the start time of the four hour block (8 a.m.) to the time offset in each  
show in the show information package to determine the show that is currently airing on that  
35 channel. Once the show is determined the system compares theme information for that show  
with the selected theme, "MOVIE". If the show is a movie, information for the show is  
extracted from the show information package. The extracted information includes title,  
primary description, secondary description and VCR+ PLUSCODE.

1           The system then increments the current time by five minutes (10:35) and repeats the  
above process. The clock is incremented again by five minutes and the process is repeated  
until the clock time is at the end of the four hour block, i.e. 12 noon. The system then  
access all remaining pointers, D1 - Dn, E1 - En, . . . , L1 - Ln, and extracts information for  
5 all shows that contain the theme "MOVIE".

Once data has been extracted for all shows occurring within the two day window  
(today and tomorrow) that contain the theme "MOVIE" the system begins extracting data  
from the "MOVIE" extended theme show list, FIG. 28. The system has the address of the  
first entry in the "MOVIE" extended theme show list since it is stored in static area 300.  
10 Data for all shows in the "MOVIE" extended theme show list is extracted.

In an alternate embodiment of the system, the system user would have the capability  
to block certain channels. Blocking a channel would inhibit the channel from being displayed  
on the system, therefore the channel would not be part of the TISPG, CSPG, or THSPG.  
This feature is implemented through the use of the control array, FIG. 30.

15           When the user selects a channel for non-display, the display flag in the control array  
is set to "0". Whenever the system user requests a program guide display, the system first  
checks the control array before proceeding with processing on the pre-established time list.  
If the control array for a specific channel is set to "0", no other processing is performed for  
that channel and the system goes on with the next channel. If the user were to re-select that  
20 channel for display in subsequent processing, the system would enact the change the next  
time a program guide was created.

The control array may also be used to inhibit the storing of data for selected channels.  
For example, in an alternative embodiment of the system, the system would first check the  
control array before storing data for a specific channel. If the control array for a specific  
25 channel contained a "0" no data corresponding to that channel would be stored. Note that  
a channel may be inhibited for display as described above without necessarily inhibiting the  
storage of data.

In another alternative embodiment the user would have the option of toggling between  
the TISPG and the CSPG as in FIG. 19. Toggling between these displays would allow the  
30 user to create a guide of all program information for a future, user selected, time. The  
database processing associated with this option is similar to that used for the TISPG and  
CSPG with the exception that the time used to locate each program is the user specified time  
in the CSPG in lieu of the current time and the channel would be that specified in the TISPG.

#### **Recording**

35           When the user selects a program for recording the system stores the internal channel  
number of the selected program and the program start time in the record queue, FIG. 32.  
The program start time is computed by adding the offset contained in the show information  
package to the start time of the associated four hour block of data.

1           The record queue is put in time order whenever a new entry is added. This ordering  
facilitates periodic polling of the start time in the first show of the queue to determine the  
next recording command to be executed. The address of the queue is known to the system  
as it is in static area 300. When a show is recorded the next show in the queue is moved to  
5 the beginning of the queue.

          When the operator requests a display of the record queue the system reads the internal  
channel number and start time for the first entry in the record queue. This data is used to  
locate the pointer to the corresponding SIP package in the pre-established time list (FIG. 25).  
The pointer is used to extract the title of the show. The internal channel number is also used  
10 to extract the source channel number and call letters corresponding to the show. The system  
then uses this information to create a line of text representative of the show to be recorded.  
This process is repeated for each show in the record queue.

          The described embodiments of the invention are only considered to be preferred and  
illustrative of the inventive concept; the scope of the invention is not to be restricted to such  
15 embodiment. Various and numerous other arrangements may be devised by one skilled in  
the art without departing from the spirit and scope of this invention. For example, the  
disclosed electronic guide features, including the techniques for navigating through the guide,  
can be used without displaying a real time image of a current television program.

20

25

30

35

1      **WHAT IS CLAIMED IS:**

- 5           1.   An entertainment system comprising:  
          a television display having a screen;  
          a source of a plurality of video programs;  
          a memory in which textual descriptions of the video programs are stored;  
          means for displaying a list of textual descriptions from the memory on a first  
portion of the screen;  
          a control device for selecting a textual description from the list on the screen;  
10   and  
          means for displaying on a second portion of the screen the video program that  
matches the selected textual description.
- 15           2.   The entertainment system of claim 1, in which the source is a television tuner and  
the video programs are broadcast television programs.
3.   The entertainment system of claim 2, in which the source is a video storage  
device and the video programs are video clips stored on the storage device.
- 20           4.   The entertainment system of claim 2, in which the video storage device is a  
video disk.
5.   The entertainment system of claim 1, in which the textual descriptions are a list  
of program schedule items that include program titles.
- 25           6.   The entertainment system of claim 5, in which the textual descriptions  
additionally include channels.
7.   The entertainment system of claim 6, in which the textual descriptions  
30   additionally include times.
8.   The entertainment system of claim 5, in which the textual descriptions  
additionally include times.
- 35           9.   The entertainment system of claim 2, additionally comprising means for  
displaying a synopsis of the selected program on a third portion of the screen.

1           10. The entertainment system of claim 9, additionally comprising means for  
displaying another synopsis of the selected program on the first portion of the screen instead  
of the list of textual descriptions

5           11. The entertainment system of claim 1, in which the  
means for displaying on a second portion of the screen the video program that matches the  
selected textual description is a picture-in-picture chip.

10           12. The entertainment system of claim 1, in which the means for displaying on a  
second portion of the screen the video program that matches the selected textual description  
comprises means for creating a split screen display.

15           13. The entertainment system of claim 1, in which the means for displaying a list of  
textual descriptions from the memory on a first portion of the screen displays a time specific  
program guide for the current time.

20           14. An entertainment system comprising:  
a television display having a screen;  
a television tuner for recovering currently broadcast video programs;  
a memory in which textual descriptions of future broadcast video programs are  
stored;  
means for displaying part of the textual descriptions from the memory on a  
first portion of the screen;  
a control device for selecting the displayed part of the textual descriptions; and  
25           means for displaying on a second portion of the screen a currently broadcast  
video program.

30           15. The entertainment system of claim 14, in which the means for displaying part  
of the textual descriptions from the memory on a first portion of the screen displays  
descriptions of programs broadcast on a single channel.

35           16. The entertainment system of claim 14, in which the means for displaying part  
of the textual descriptions from the memory on a first portion of the screen displays  
descriptions of programs broadcast at a single time.

          17. The entertainment system of claim 14, in which the means for displaying part  
of the textual descriptions from the memory on a first portion of the screen displays  
descriptions of programs having a single theme.

1           18. The entertainment system of claim 14, additionally comprising means for  
selecting one of the displayed textual descriptions, the memory also storing textual  
descriptions of currently broadcast video programs, the means for displaying part of the  
textual descriptions from the memory on a first portion of the screen displaying currently  
5 broadcast video programs or future video programs depending on the part selected by the  
control device, and the means for displaying on a second portion of the screen a current  
broadcast video program displaying a program that matches the selected textual description  
when the displayed part comprises currently broadcast video program.

10

15

20

25

30

35

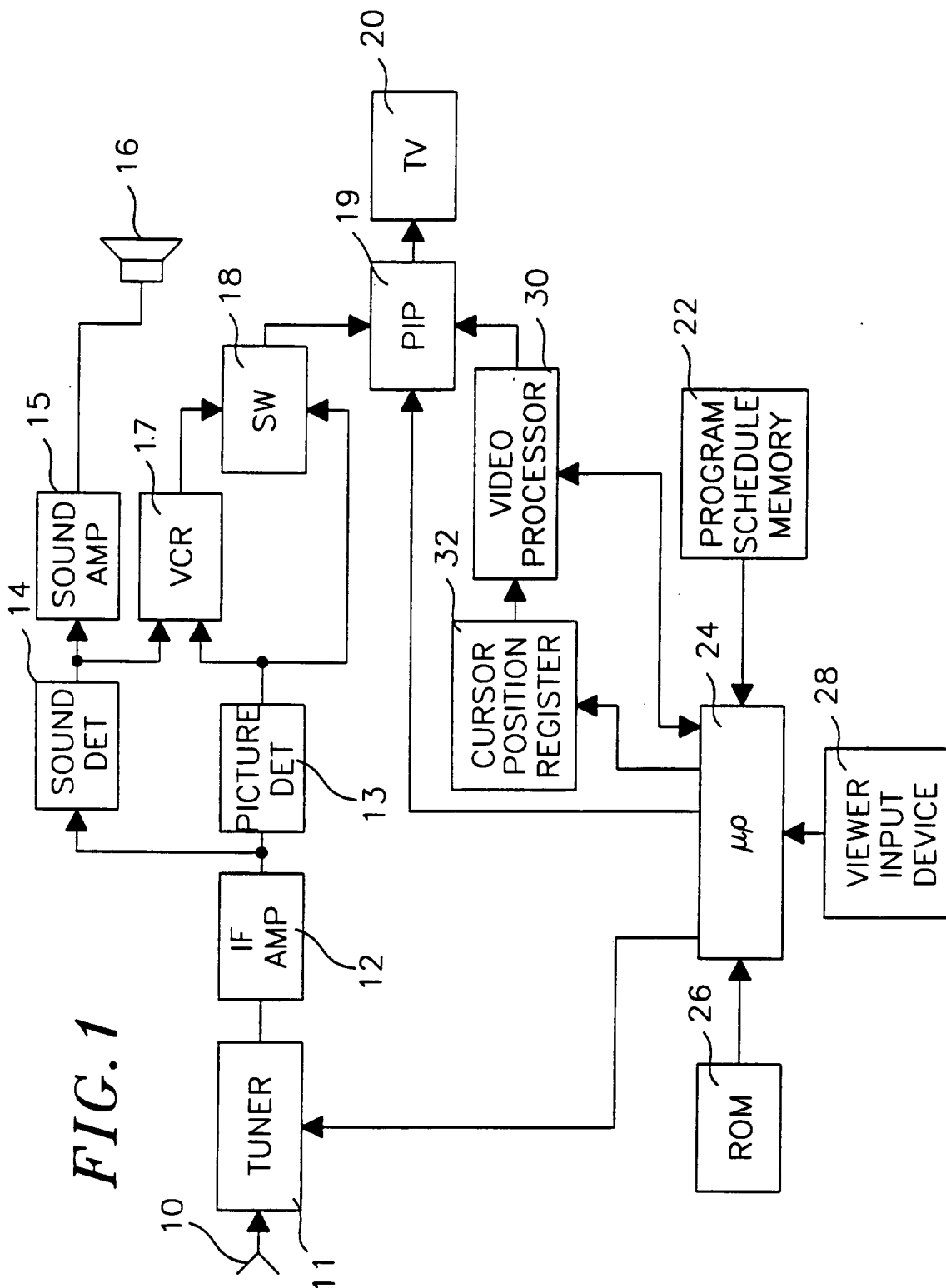

FIG. 1

FIG. 2

43

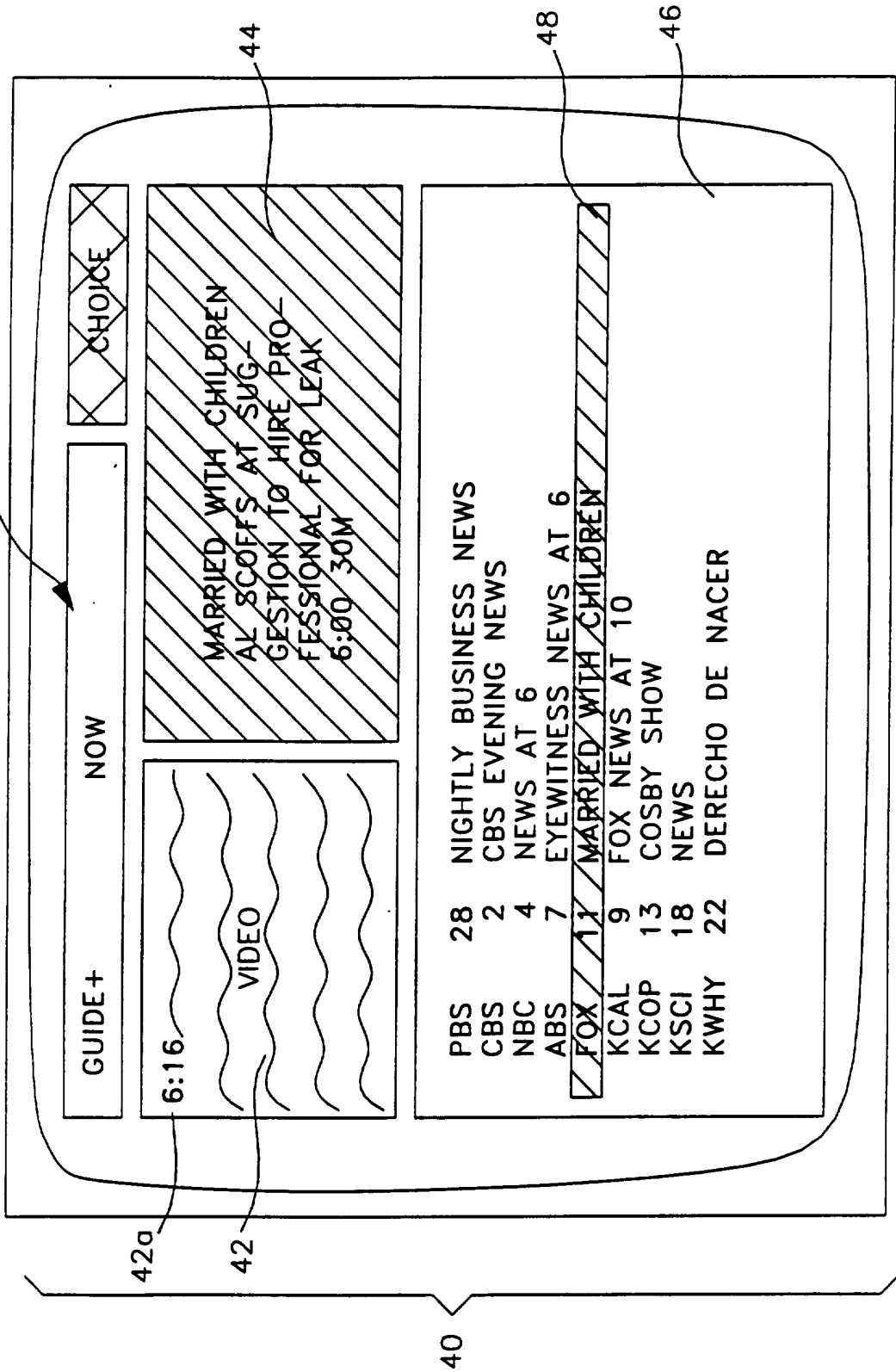
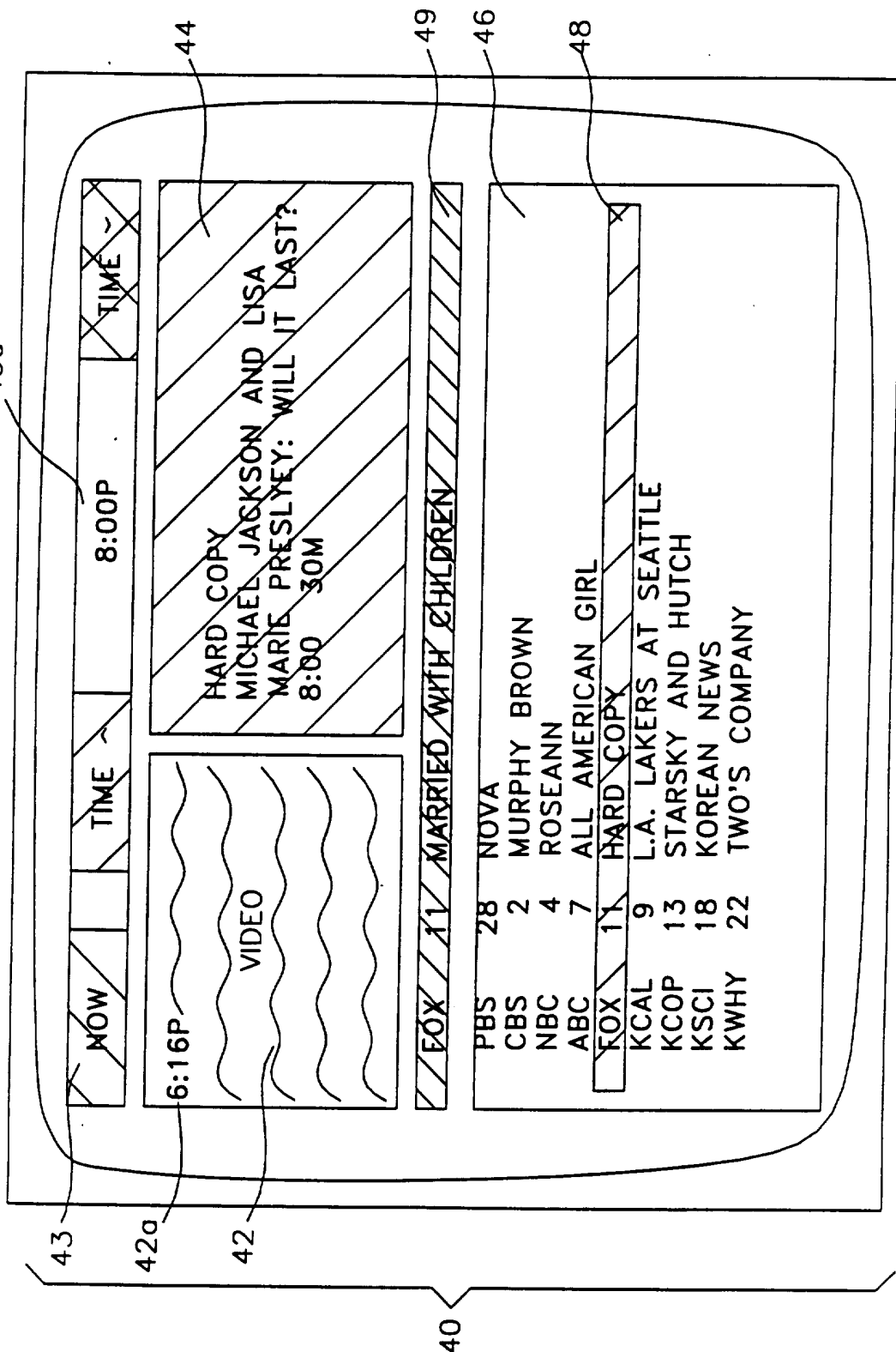

FIG. 3



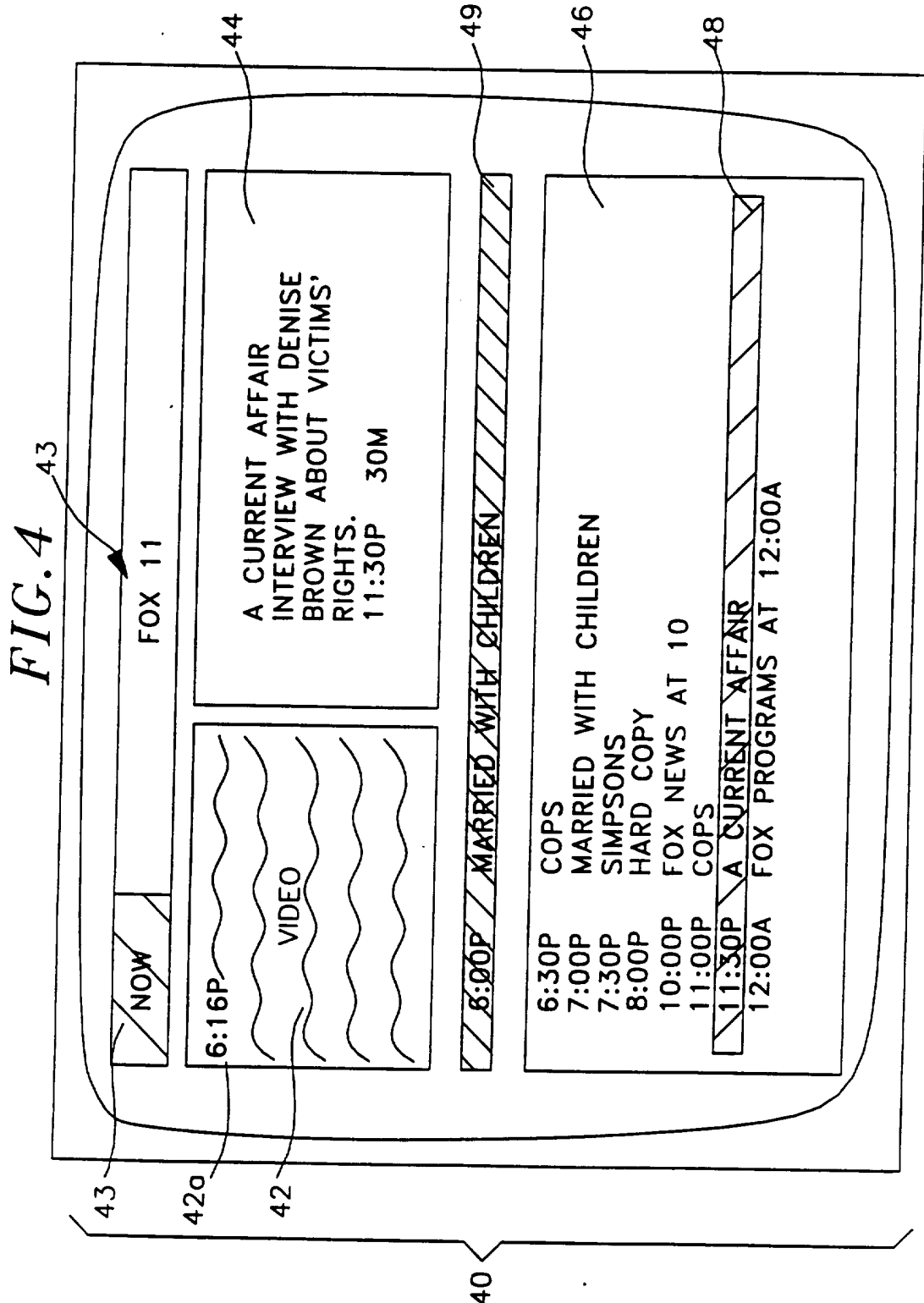

FIG. 5

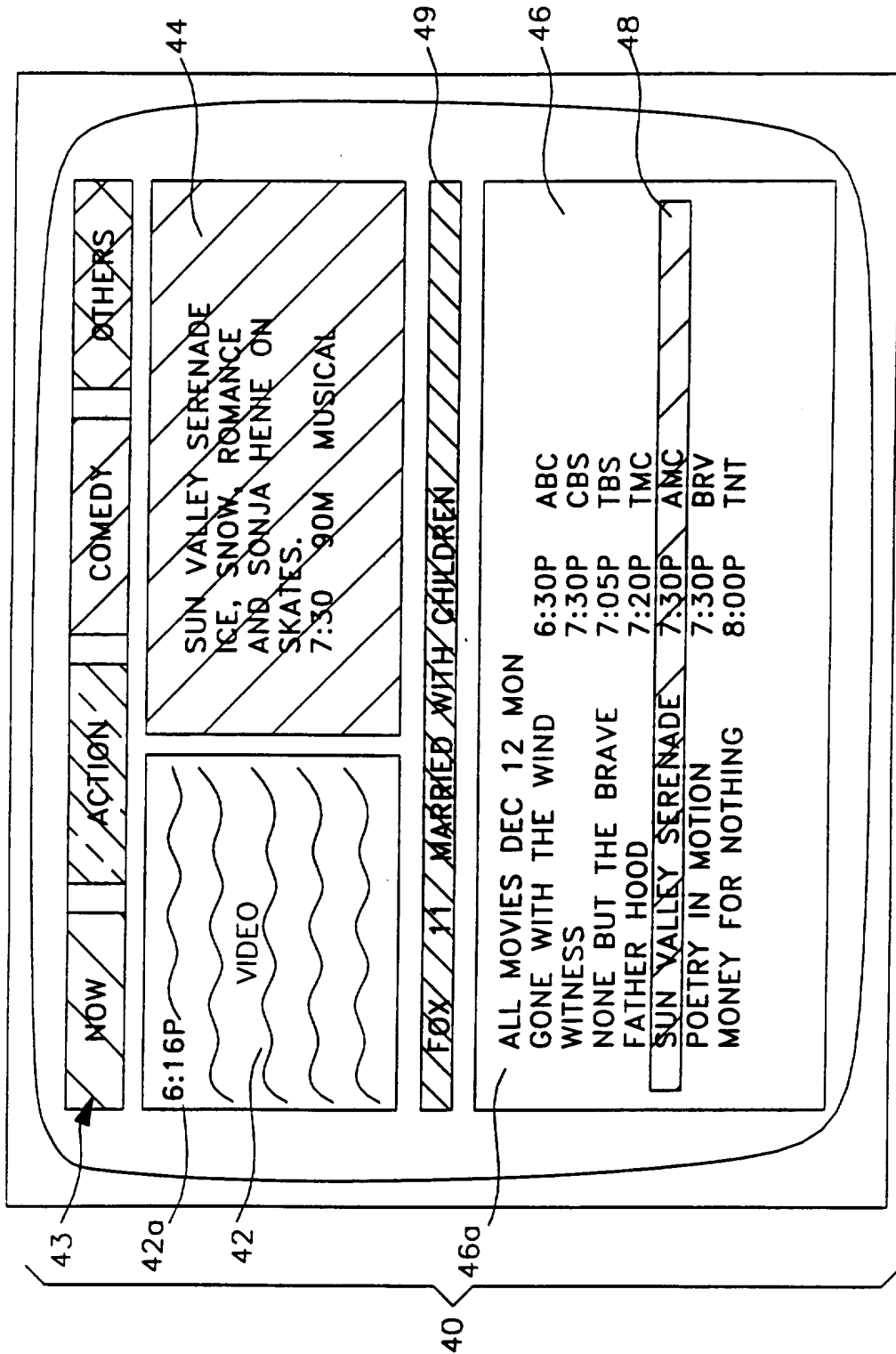
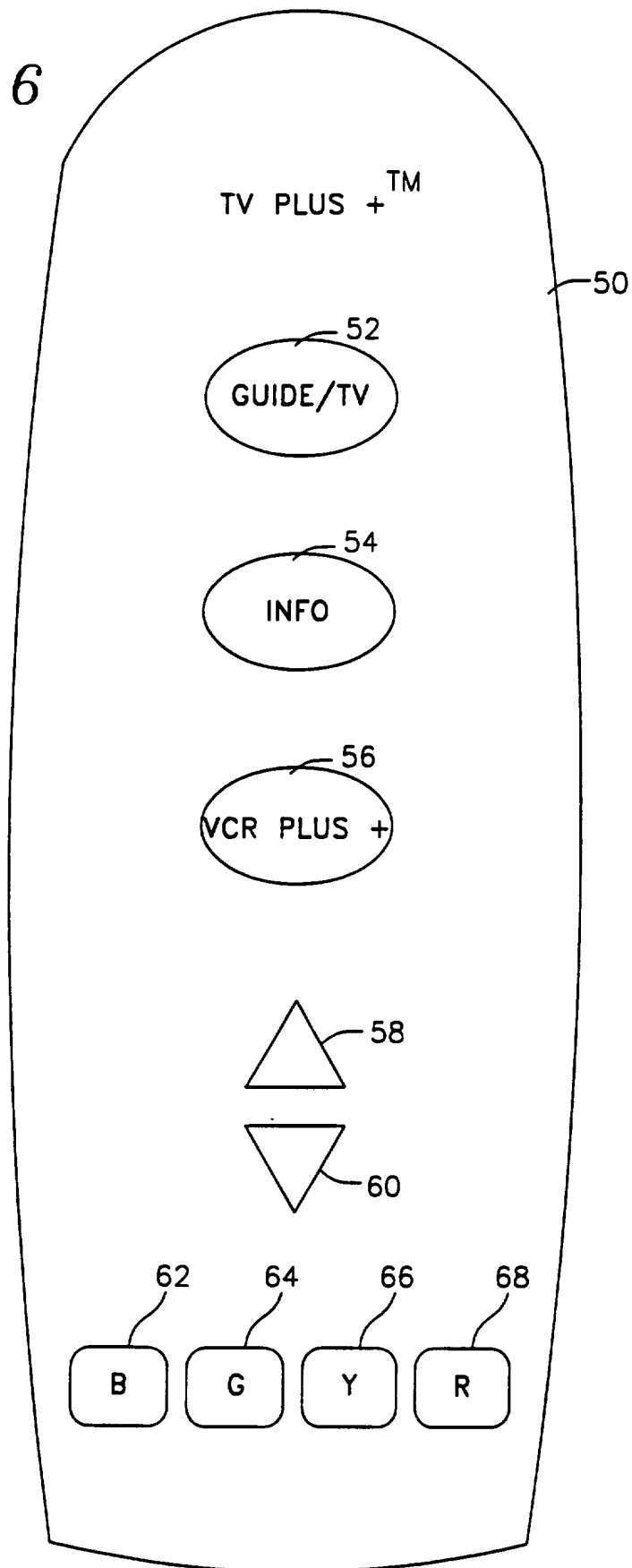
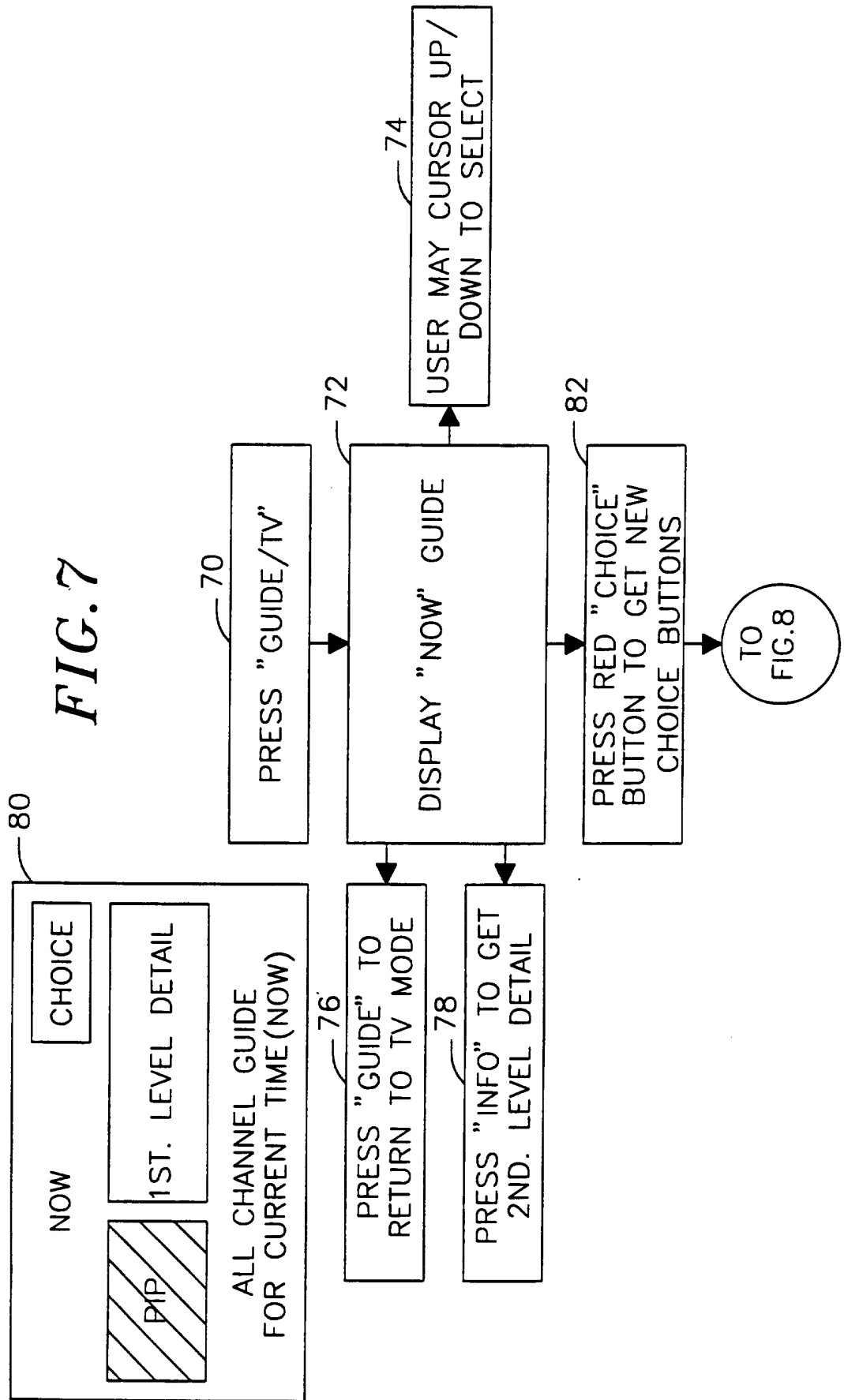

FIG. 6





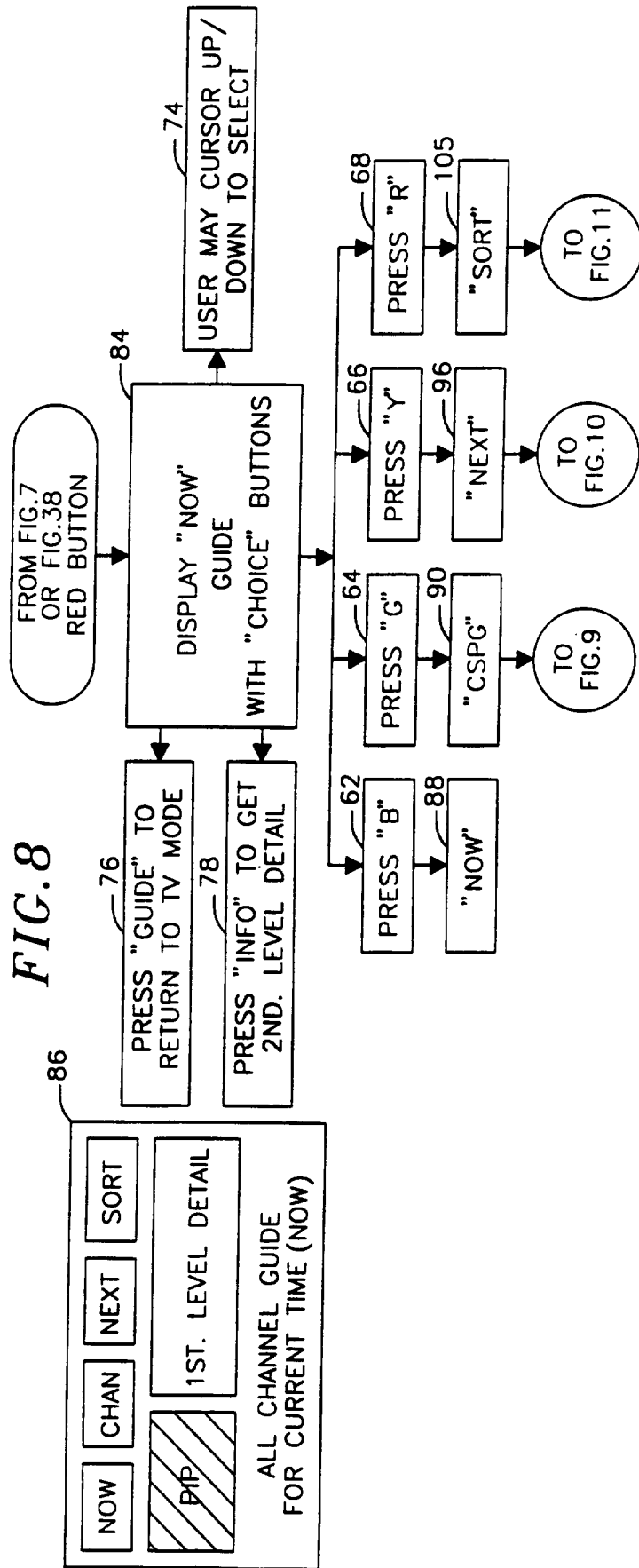

FIG. 8

FIG. 9

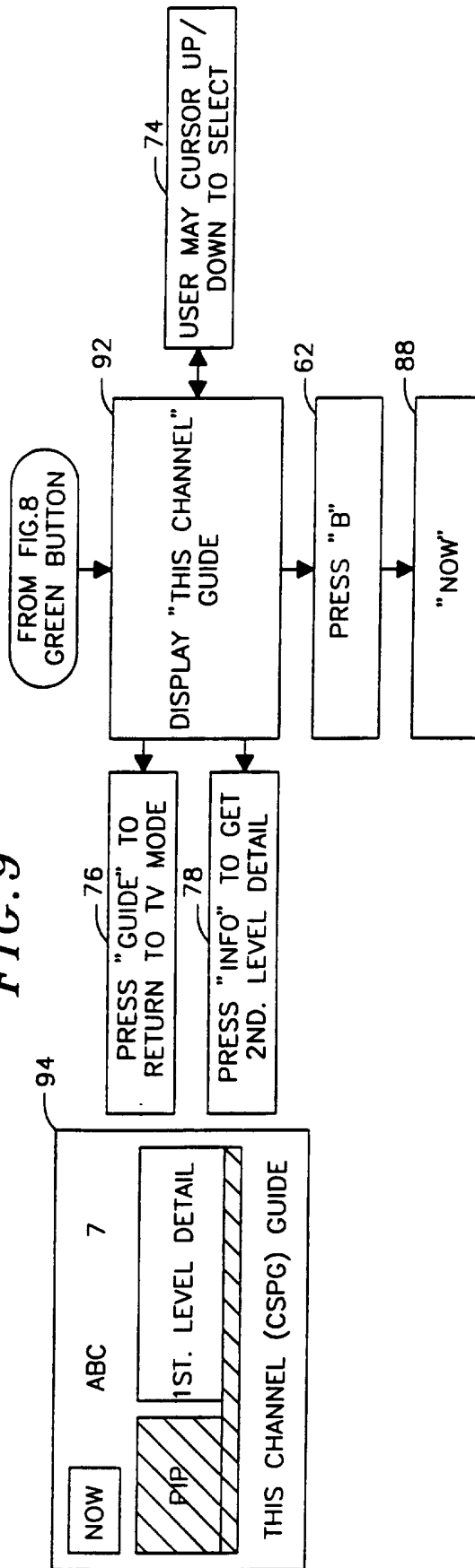
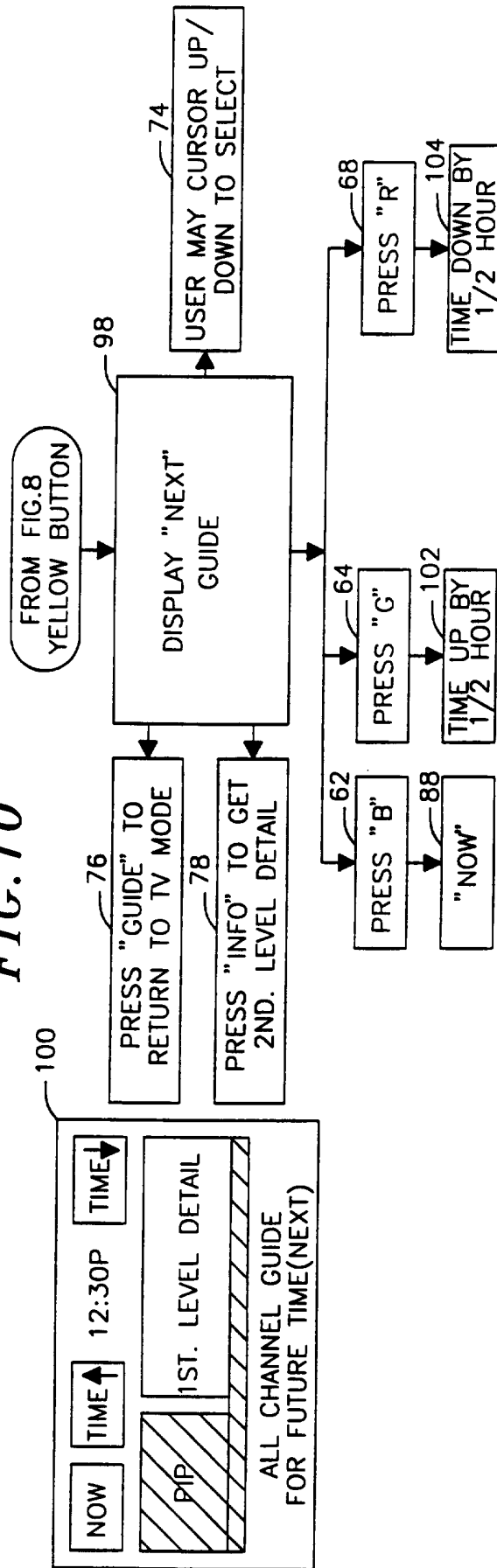
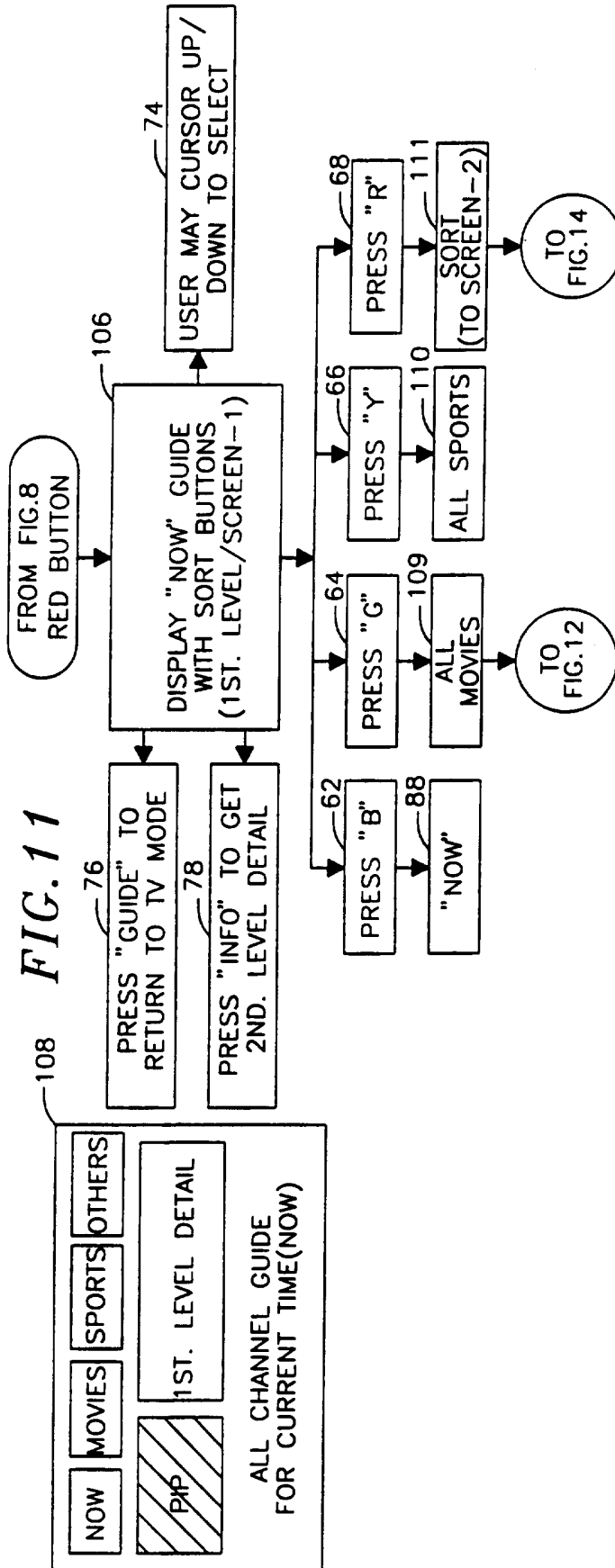

FIG. 10





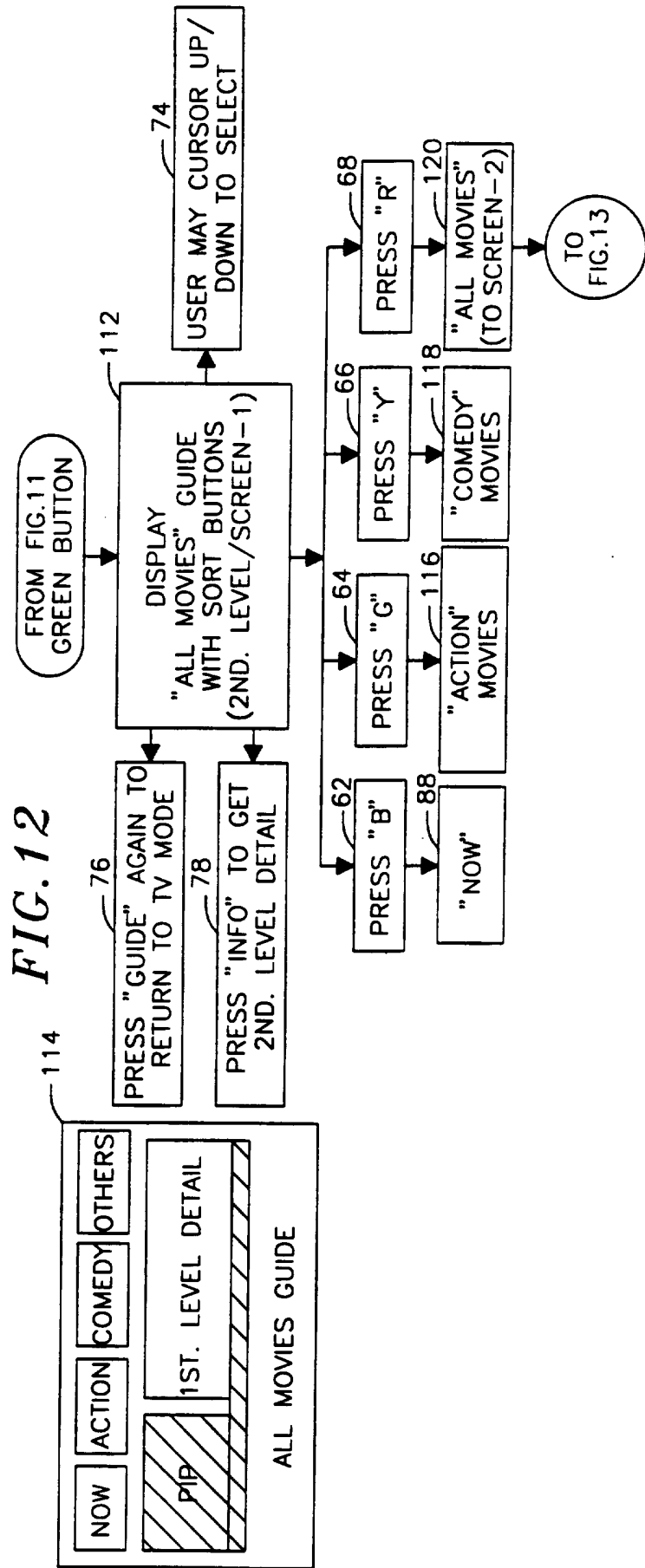



FIG. 14

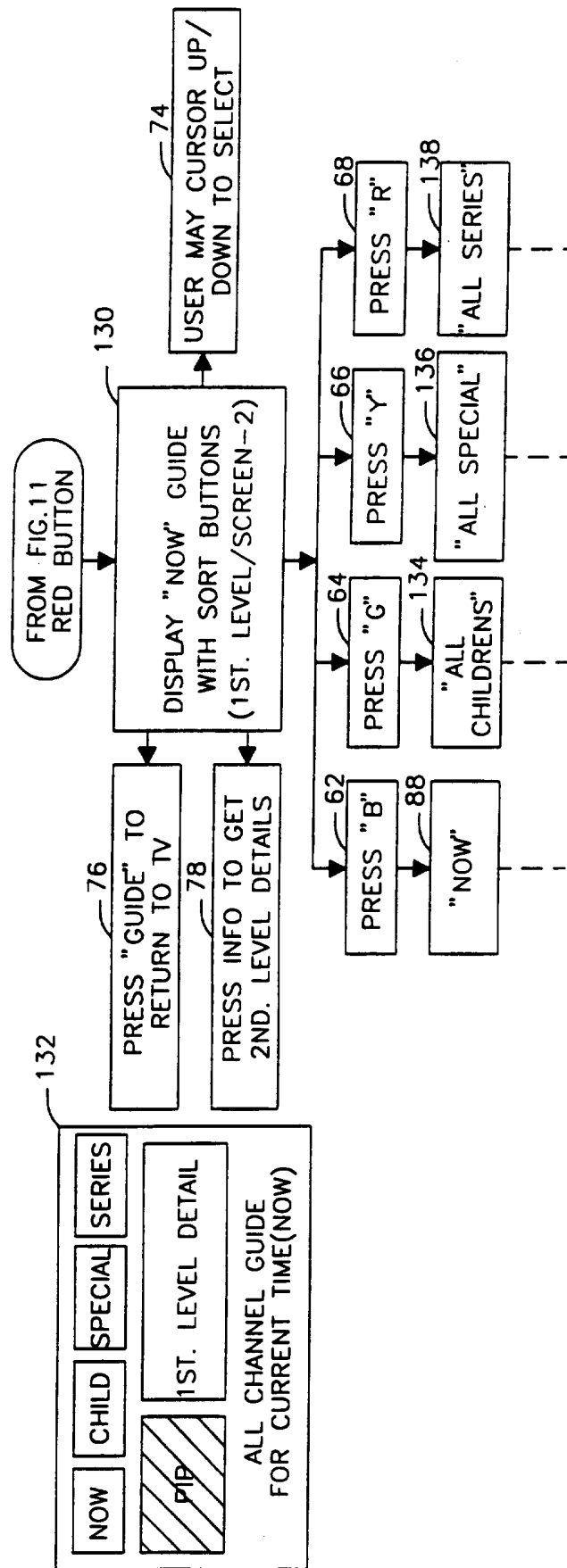

FIG. 15

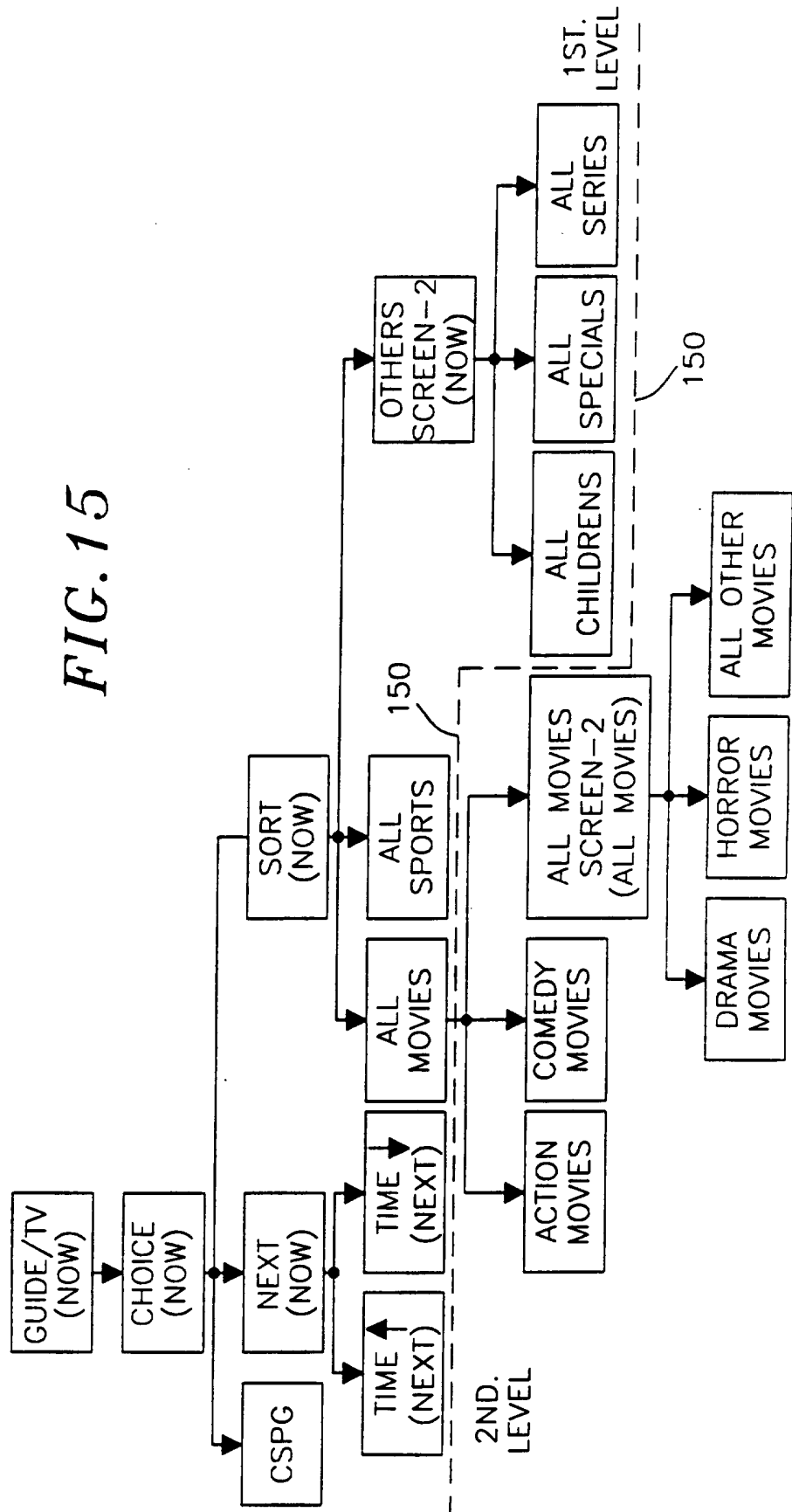

FIG. 16

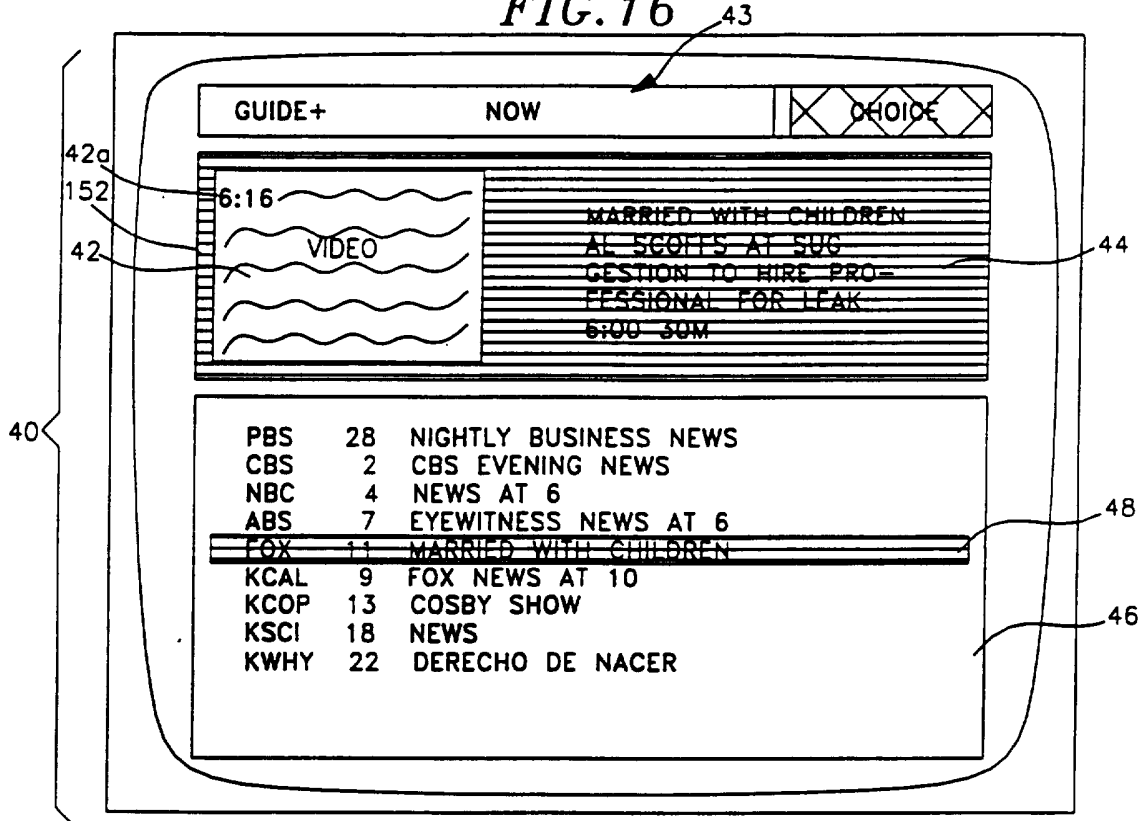

FIG. 17

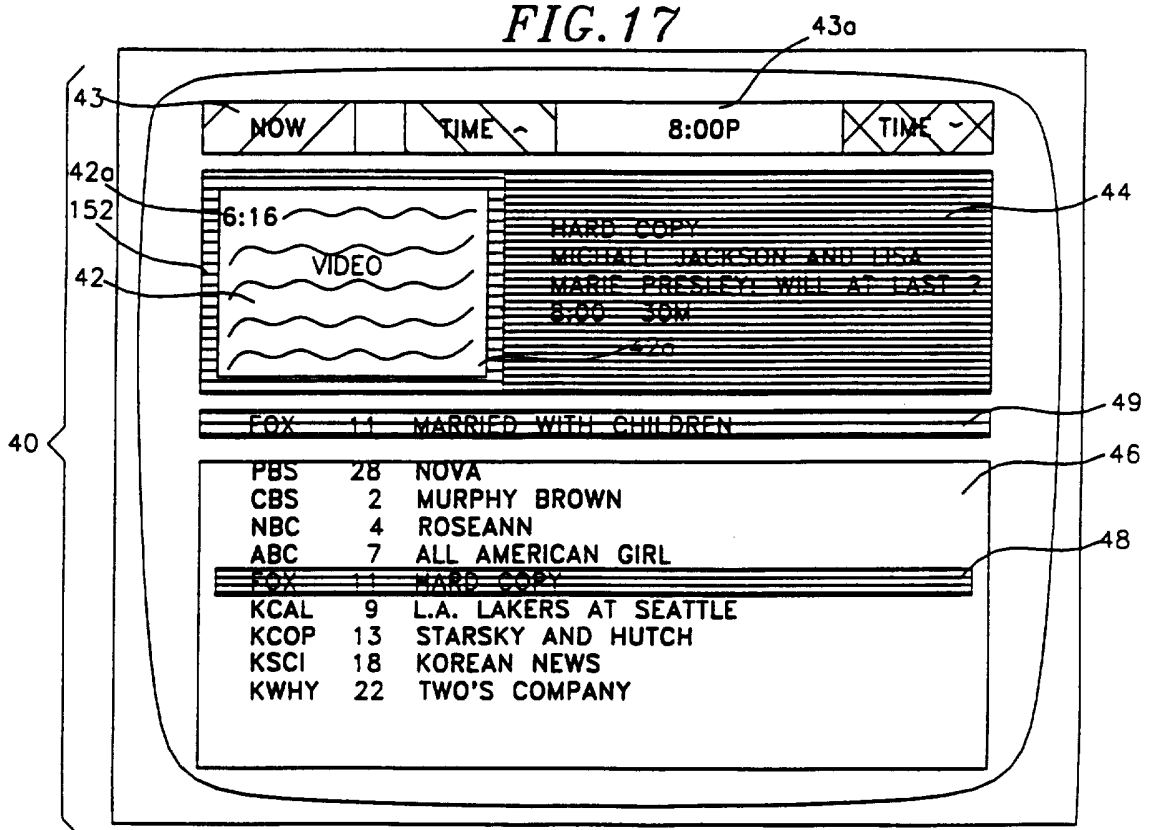

FIG. 18

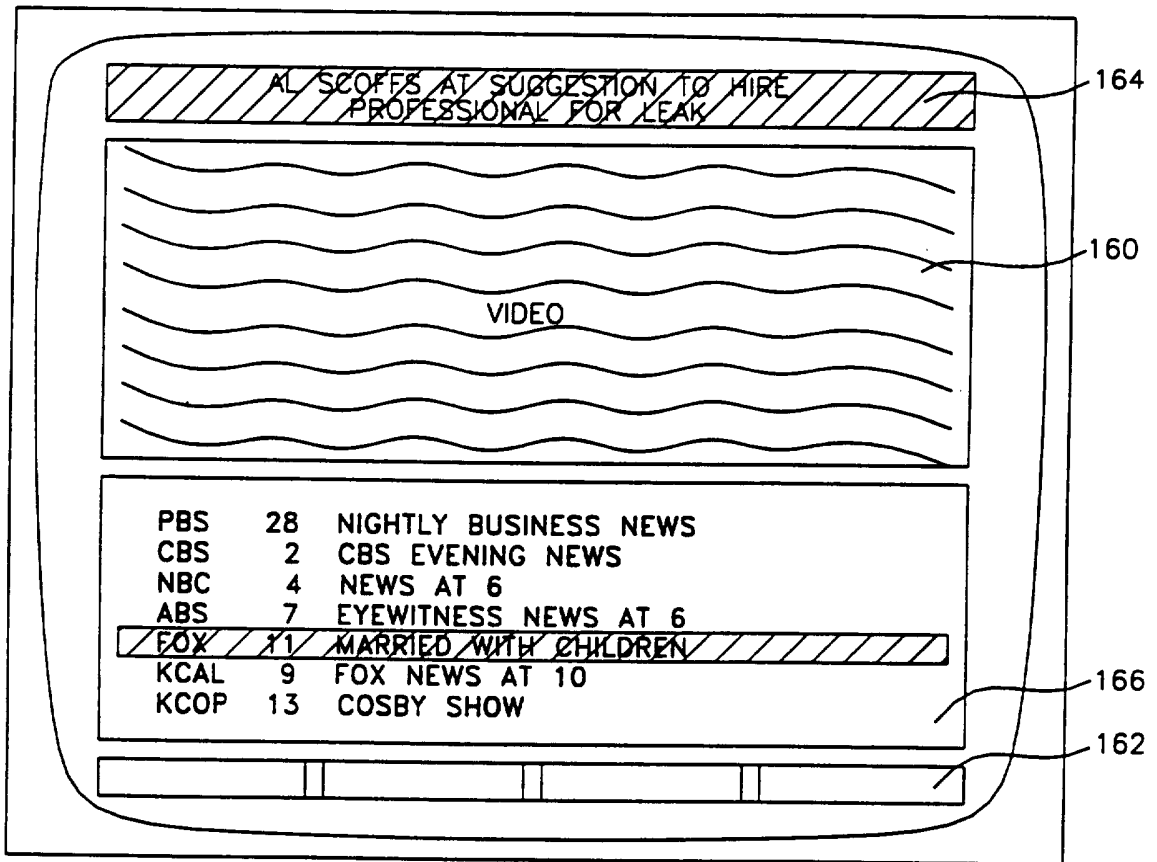
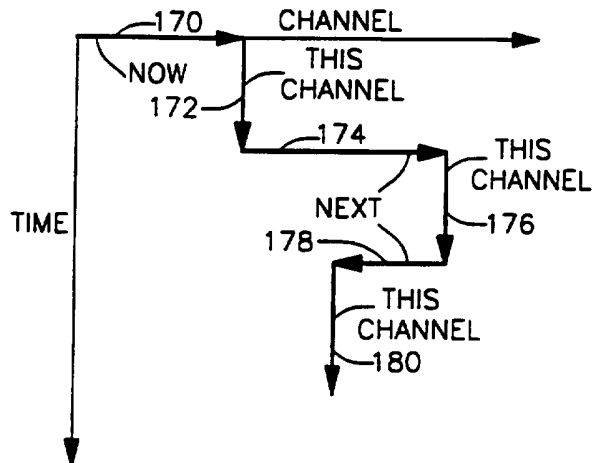
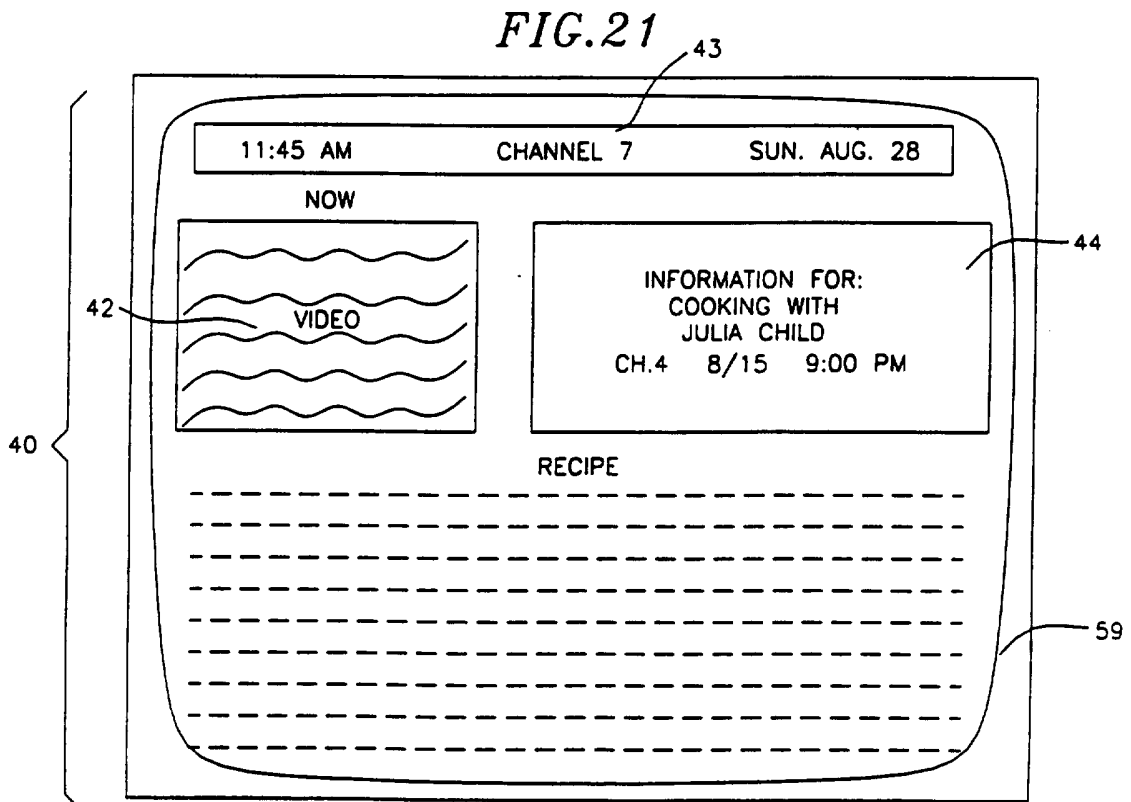
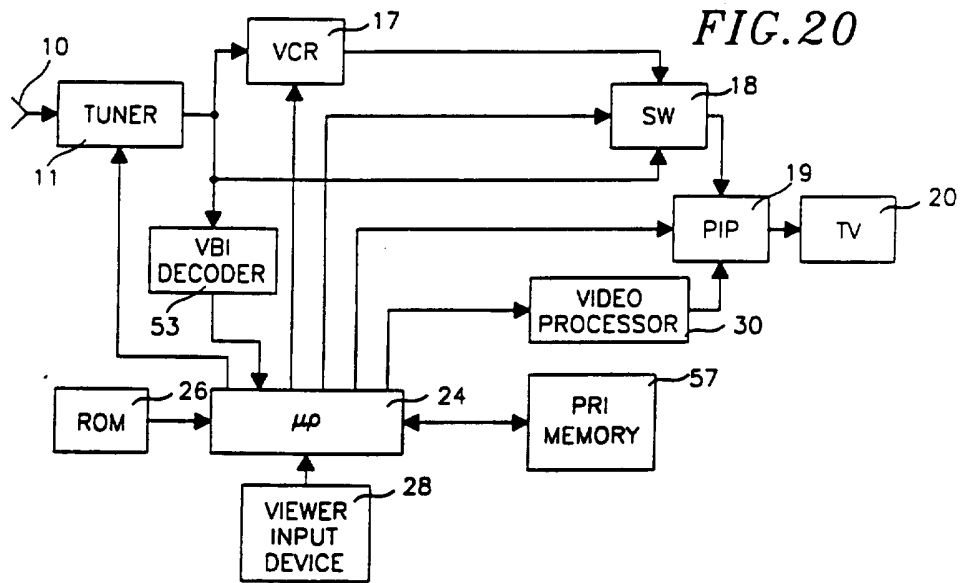

FIG. 19





**FIG. 22**

RAM MEMORY DATA BASE

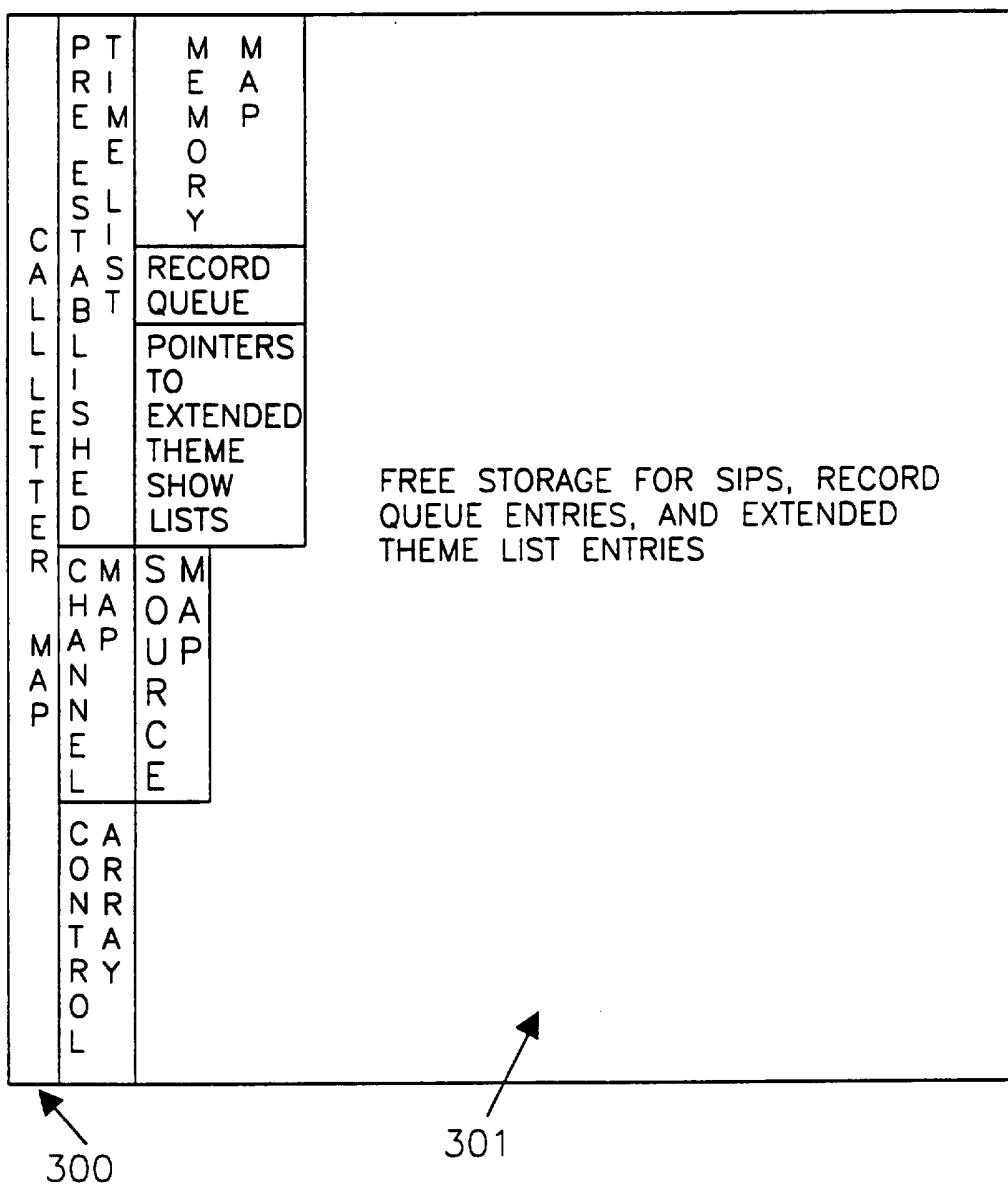
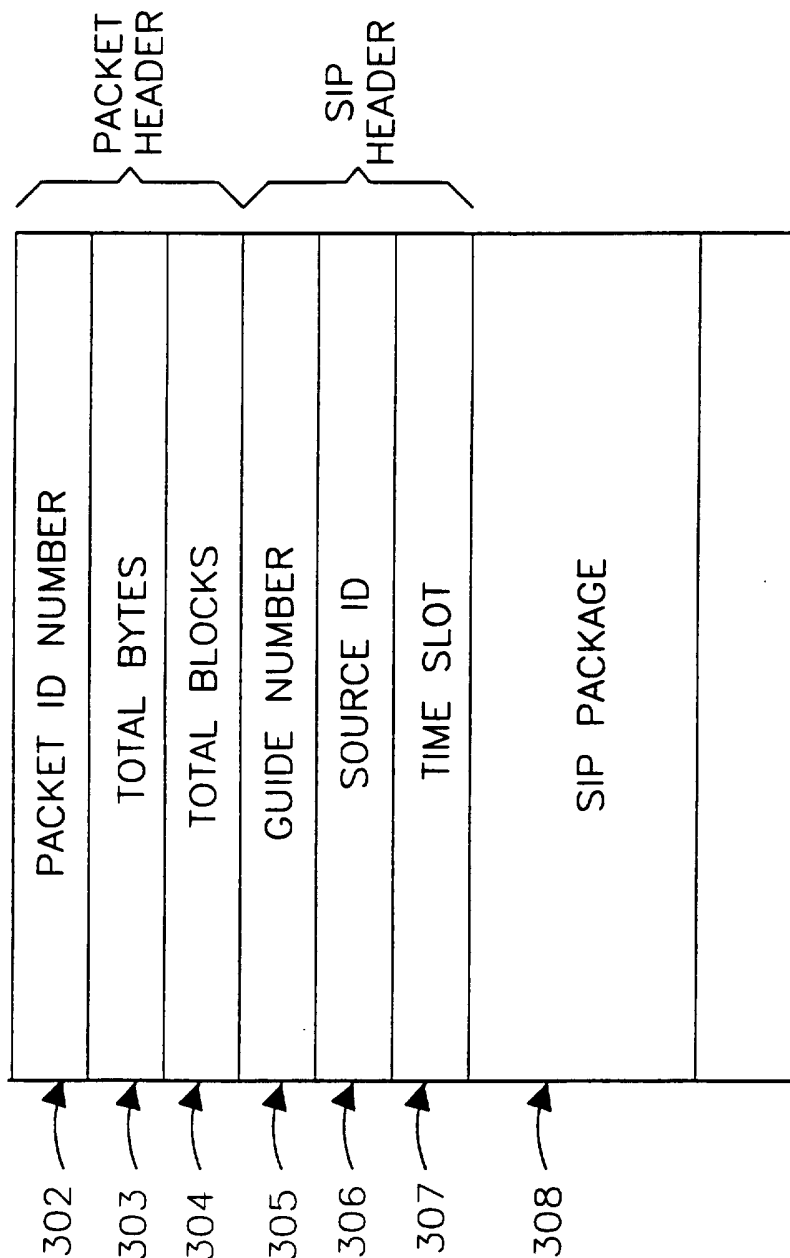

FIG. 23



# FIG. 24

## MEMORY BIT MAP

	7	6	5	4	3	2	1	0
0	1	1	1	1	0	1	1	1
1	1	0	0	1	1	1	0	1
2	1	1	1	1	1	1	1	1
3	0	0	0	0	0	0	0	0
4	1	1	1	1	1	1	0	0
5	1	1	1	1	0	0	1	1
6	1	0	1	1	1	1	1	1
7	1	1	0	0	0	0	0	1
8	1	0	0	1	1	1	1	0
9	0	1	1	1	1	1	0	0
10	0	0	0	0	0	0	0	0
11	0	0	0	0	0	0	0	0
12	0	0	0	0	0	0	0	0
13	1	1	1	1	1	1	0	1
14	1	1	1	1	1	1	1	1
15	1	1	1	0	1	0	0	0
16	0	0	0	0	0	0	0	0
17	0	0	0	0	1	1	0	1

310

311

312

**FIG.25**

PRE-ESTABLISHED TIME LIST

	00-04	04-08	08-12	12-16	16-20	20-24
1	A <sub>1</sub>	B <sub>1</sub>	C <sub>1</sub>	D <sub>1</sub>	E <sub>1</sub>	F <sub>1</sub>
2	G <sub>1</sub>	H <sub>1</sub>	I <sub>1</sub>	J <sub>1</sub>	K <sub>1</sub>	L <sub>1</sub>
3	A <sub>2</sub>	B <sub>2</sub>	C <sub>2</sub>	D <sub>2</sub>	E <sub>2</sub>	F <sub>2</sub>
4	G <sub>2</sub>	H <sub>2</sub>	I <sub>2</sub>	J <sub>2</sub>	K <sub>2</sub>	L <sub>2</sub>
5	A <sub>3</sub>	B <sub>3</sub>	C <sub>3</sub>	D <sub>3</sub>	E <sub>3</sub>	F <sub>3</sub>
6	G <sub>3</sub>	H <sub>3</sub>	I <sub>3</sub>	J <sub>3</sub>	K <sub>3</sub>	L <sub>3</sub>
Z <sub>N-1</sub>	A <sub>N</sub>	B <sub>N</sub>	C <sub>N</sub>	D <sub>N</sub>	E <sub>N</sub>	F <sub>N</sub>
Z <sub>N</sub>	G <sub>N</sub>	H <sub>N</sub>	I <sub>N</sub>	J <sub>N</sub>	K <sub>N</sub>	L <sub>N</sub>

N=THE MAXIMUM NUMBER OF CHANNELS

**FIG.26**

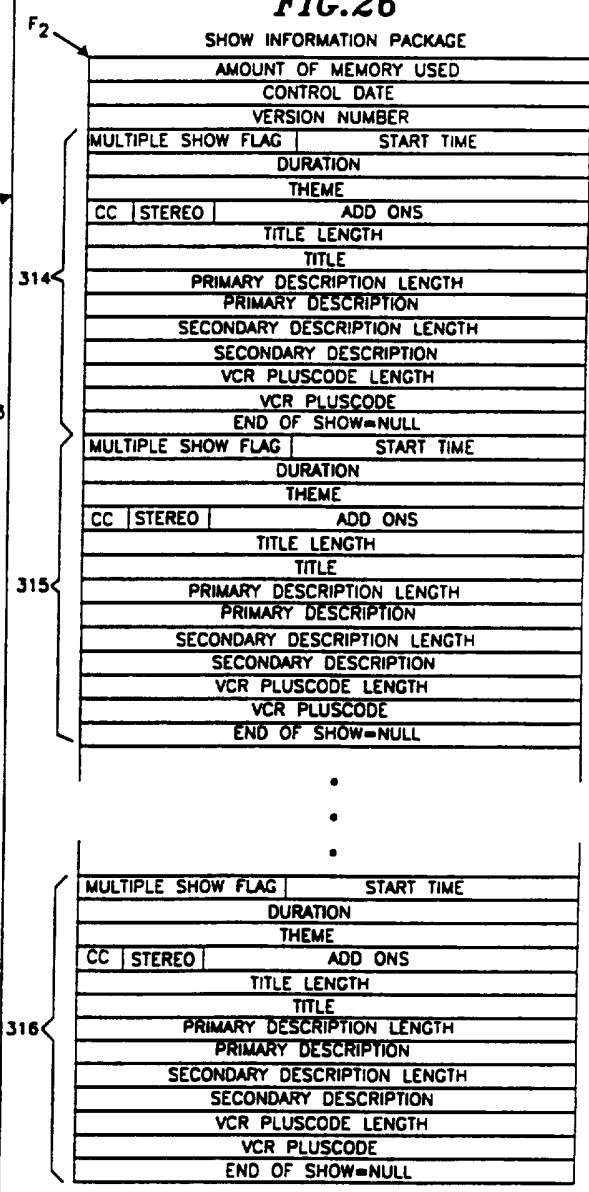

# FIG. 27

SHOW INFORMATION PACKAGE FEATURES

SECONDARY DESCRIPTION LENGTH=MAX
SECONDARY DESCRIPTION LENGTH
SECONDARY DESCRIPTION
VCR PLUSCODE LENGTH
VCR PLUSCODE
EXTRA DATA LENGTH
EXTRA DATA
END OF SHOW=NULL

FIG. 28

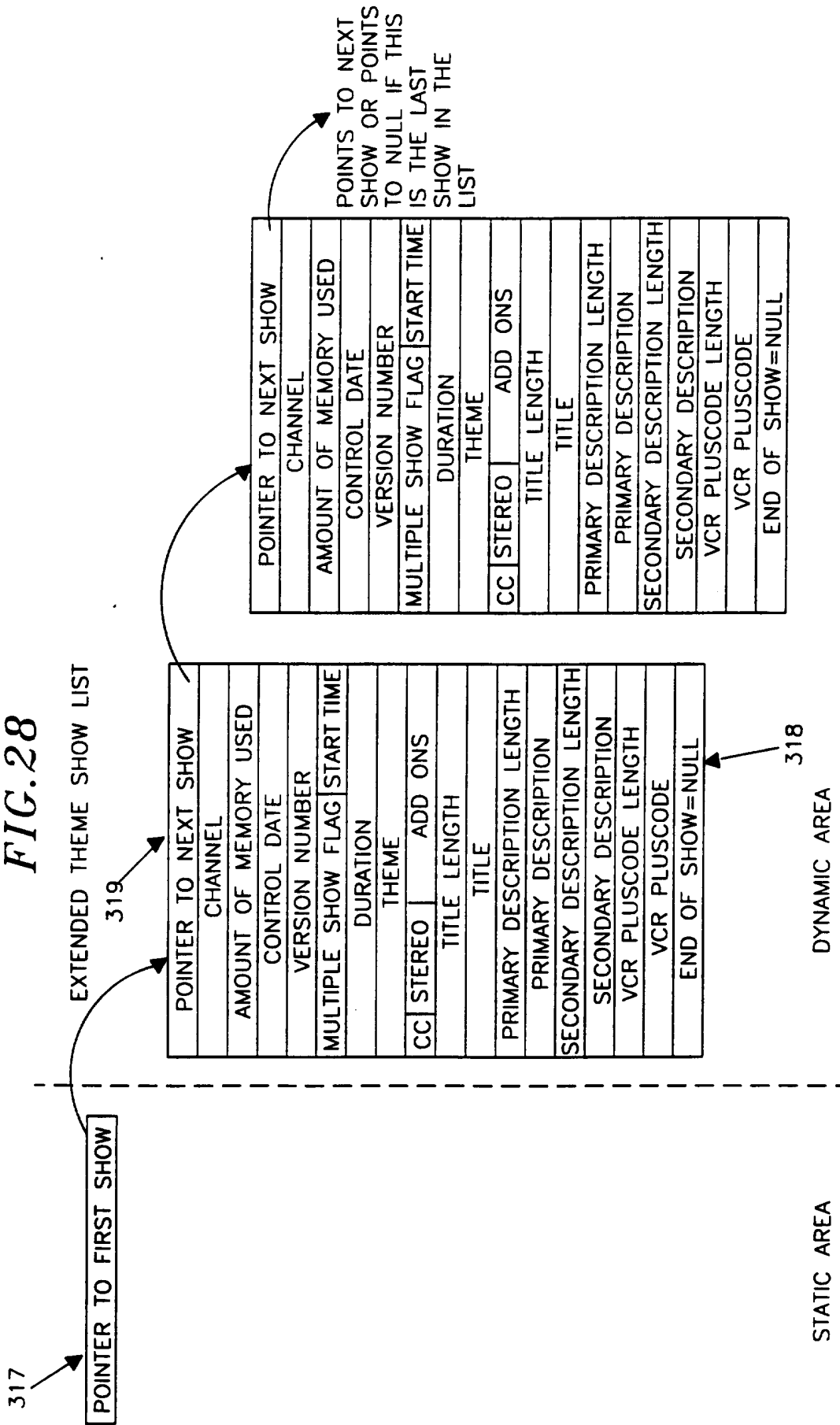

**FIG. 29**  
CHANNEL MAP

1	7
2	6
3	11
4	2
5	4
	•
	•
	•
N	172

N=MAX NUMBER OF CHANNELS

**FIG. 30**

320  
CONTROL ARRAY

1	DISPLAY	ADD ONS
2	DISPLAY	ADD ONS
3	DO NOT DISPLAY	ADD ONS
4	DISPLAY	ADD ONS
5	DISPLAY	ADD ONS
	•	
	•	
	•	
N	DISPLAY	ADD ONS

N=MAX NUMBER OF CHANNELS

**FIG. 31**

CALL LETTER MAP

1	K
2	A
3	B
4	C
5	W
6	W
7	O
	R
	•
	•
	•
(N×4)-3	K
(N×4)-2	T
(N×4)-1	V
N×4	R

**FIG. 32**

RECORD QUEUE

1	CHANNEL	START TIME
2	CHANNEL	START TIME
3	CHANNEL	START TIME
		•
		•
		•
20	CHANNEL	START TIME

FIG. 33

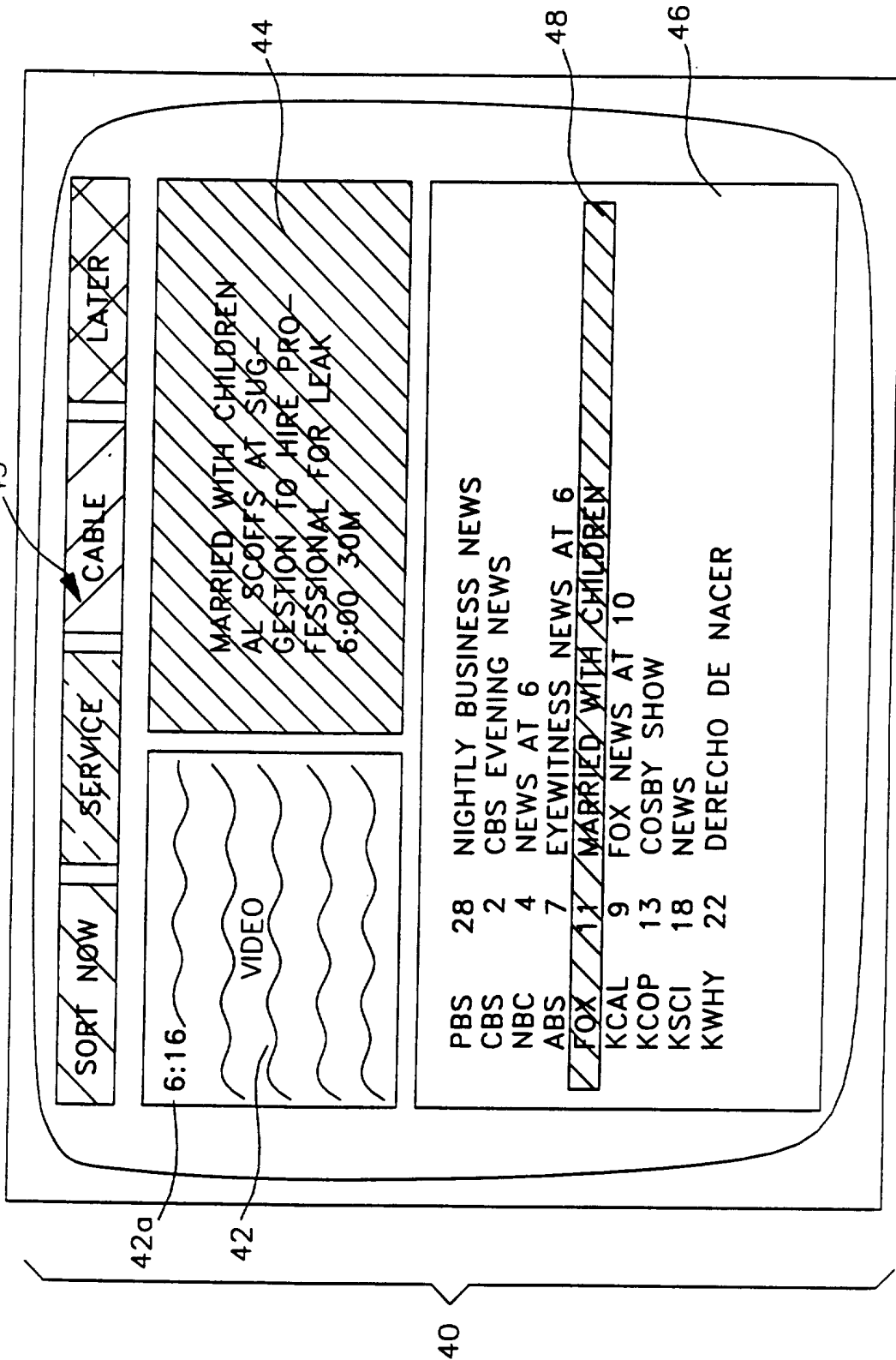

FIG. 34

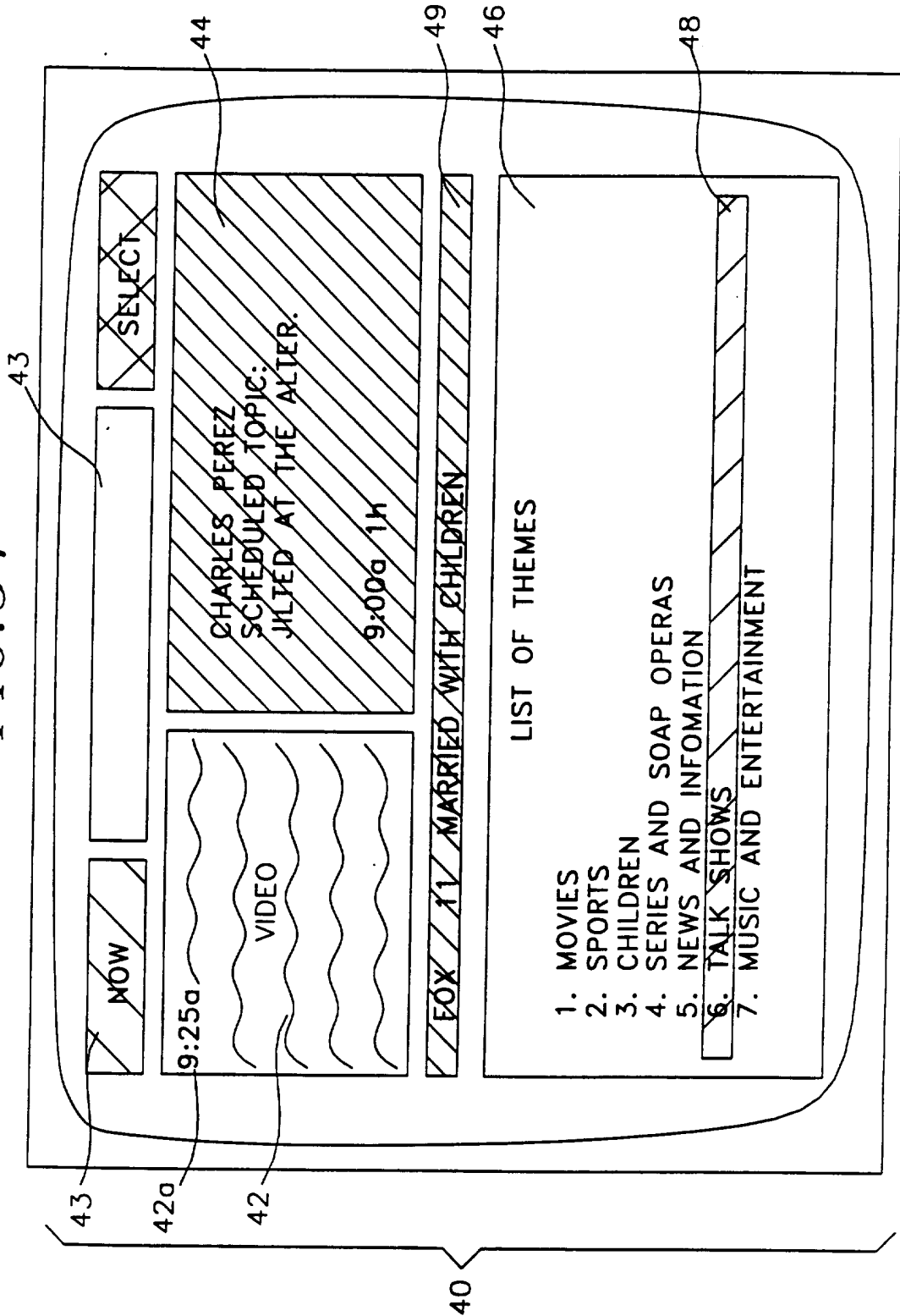

FIG. 35

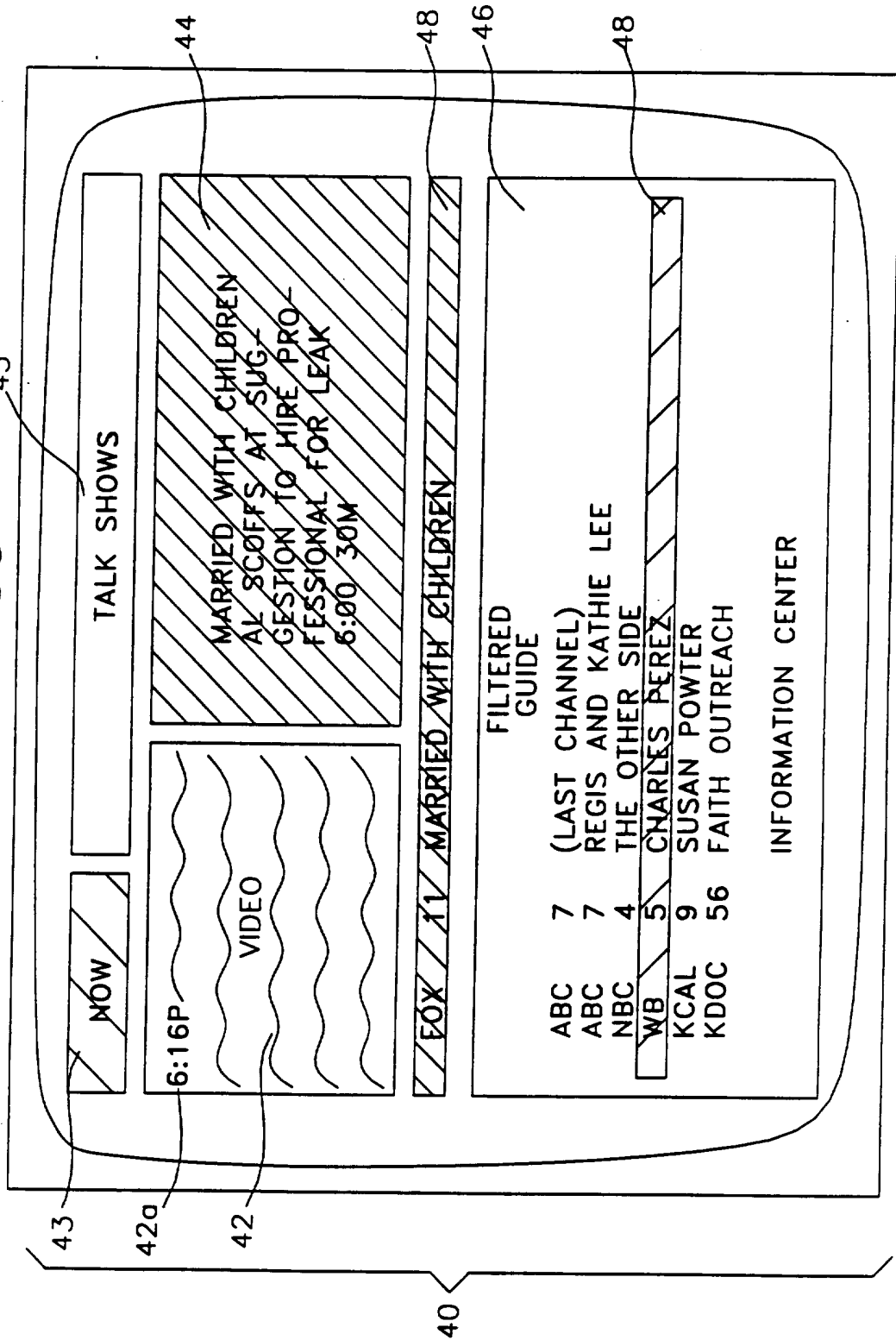
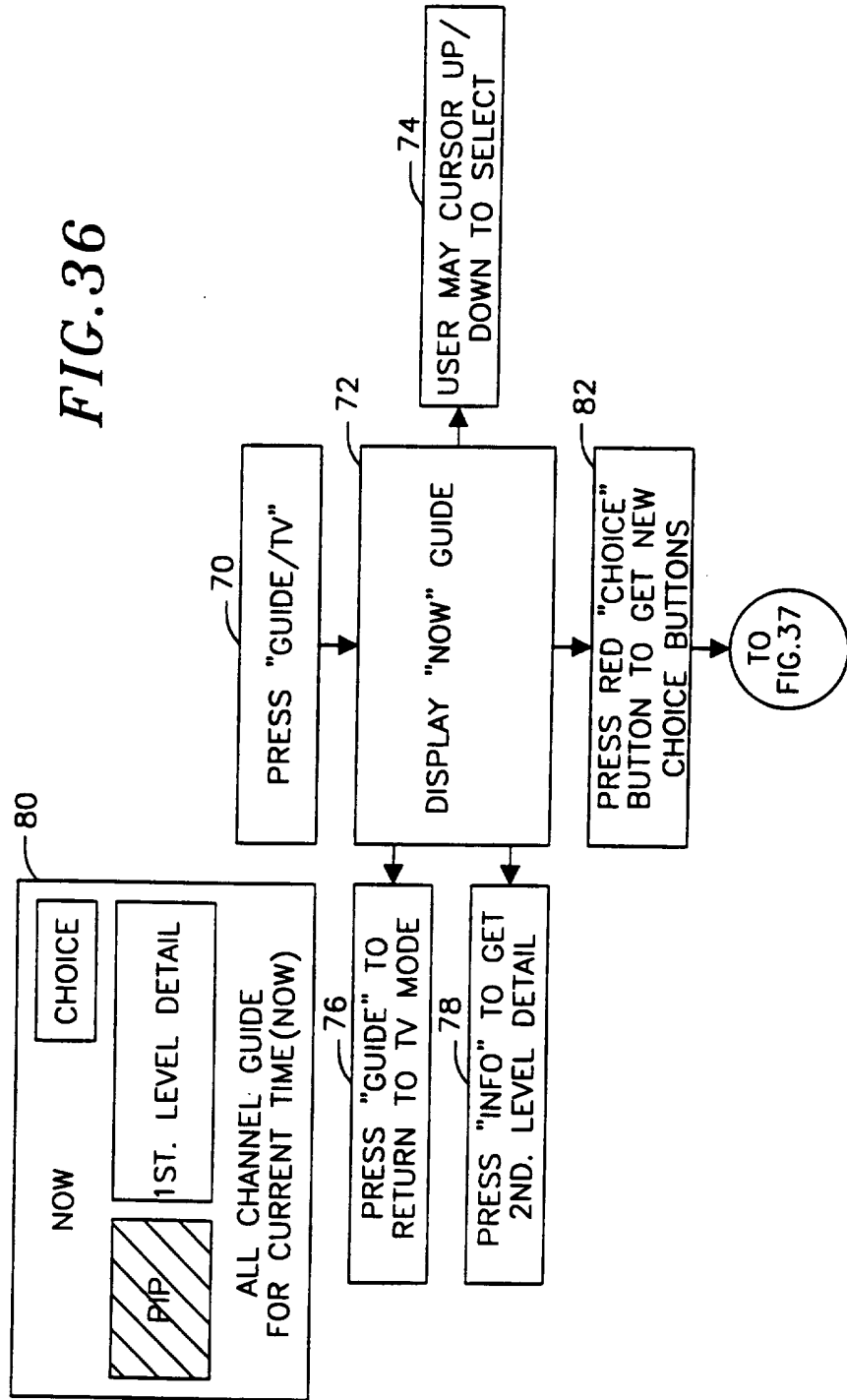
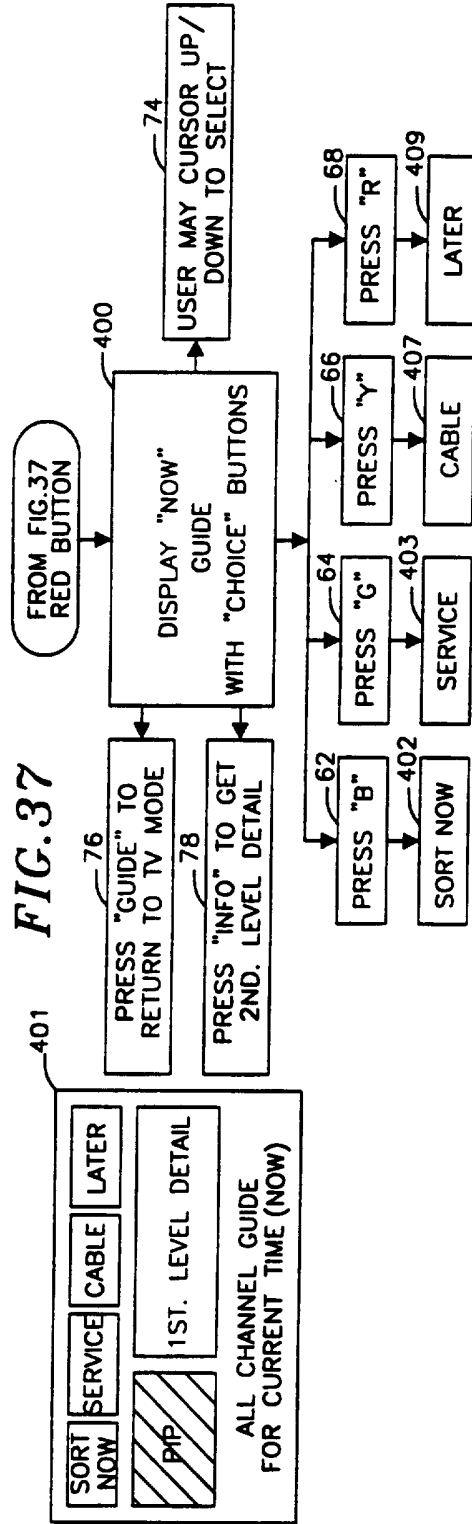
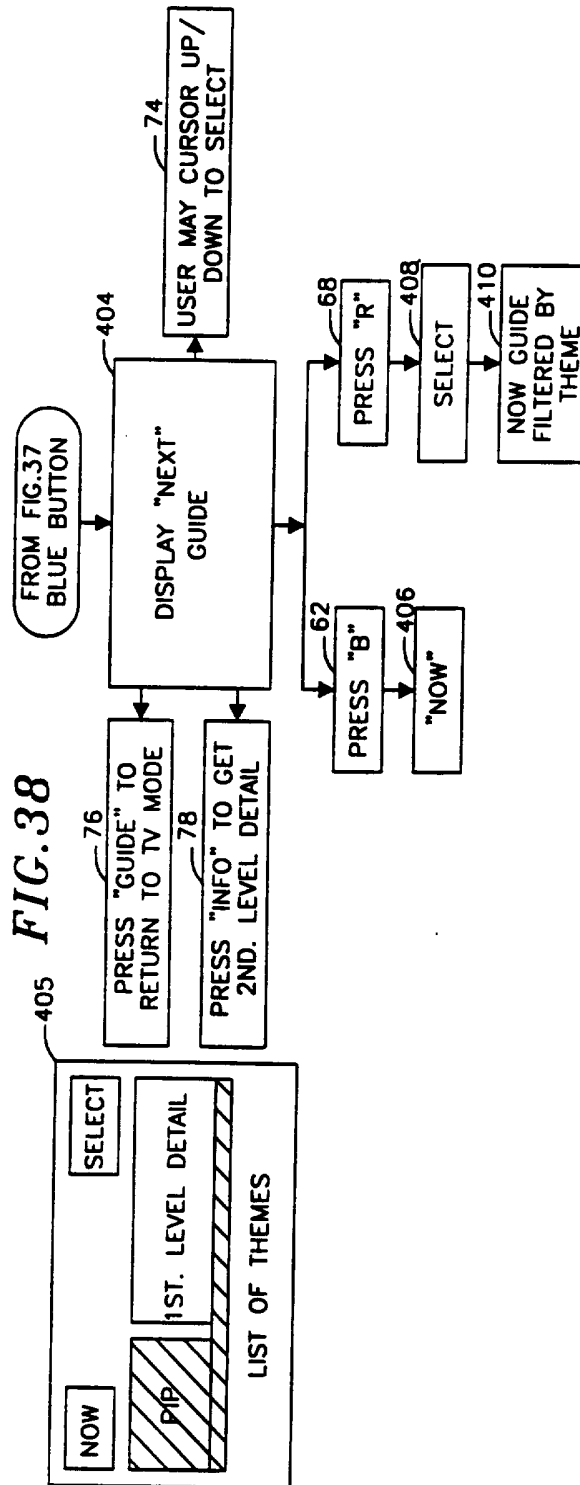

FIG. 36







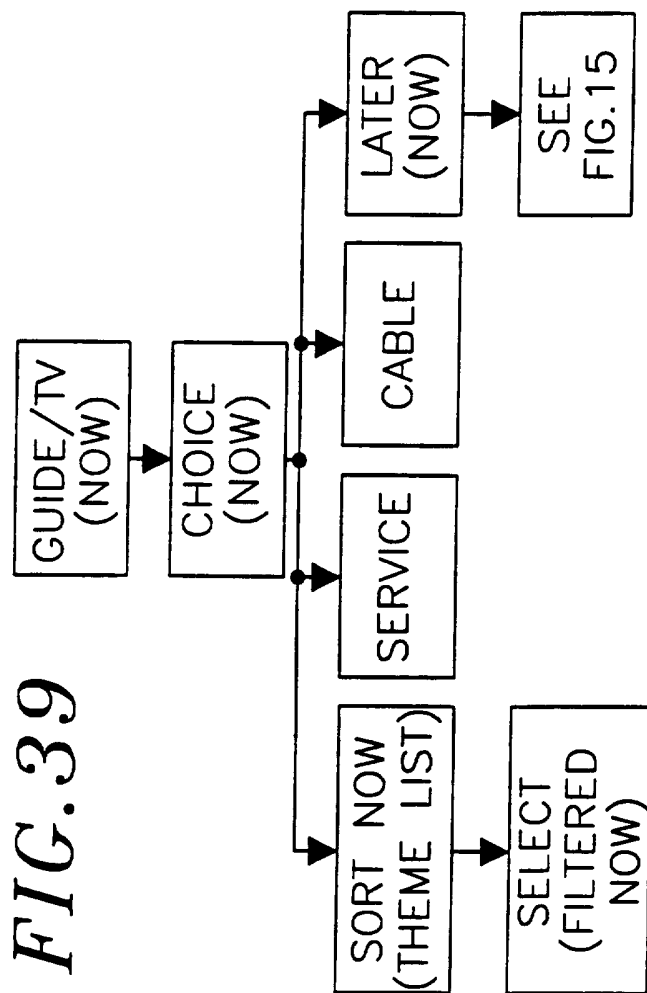

FIG. 39

# INTERNATIONAL SEARCH REPORT

Int. Patent Application No  
PCT/US 95/11173

A. CLASSIFICATION OF SUBJECT MATTER  
IPC 6 H04N5/445 H04N7/087

According to International Patent Classification (IPC) or to both national classification and IPC

**B. FIELDS SEARCHED**

Minimum documentation searched (classification system followed by classification symbols)  
IPC 6 H04N

Documentation searched other than minimum documentation to the extent that such documents are included in the fields searched

Electronic data base consulted during the international search (name of data base and, where practical, search terms used)

**C. DOCUMENTS CONSIDERED TO BE RELEVANT**

Category *	Citation of document, with indication, where appropriate, of the relevant passages	Relevant to claim No.
X	EP,A,0 444 496 (HITACHI LTD) 4 September 1991	14
Y	see page 2, line 40 - line 52  see page 5, line 6 - page 6, line 7; figures 1,2	1,2,5-8, 11,12
Y	--- GB,A,2 217 144 (TOKYO SHIBAURA ELECTRIC CO ;TOSHIBA AUDIO VIDEO ENG (JP)) 18 October 1989 see abstract see page 2, line 22 - page 4, line 11; figure 1 see page 11, line 12 - page 12, line 1; figure 3  --- -/--	1,2,5-8, 11,12, 14-16,18

Further documents are listed in the continuation of box C.

Patent family members are listed in annex.

\* Special categories of cited documents :

- \*A\* document defining the general state of the art which is not considered to be of particular relevance
- \*E\* earlier document but published on or after the international filing date
- \*L\* document which may throw doubts on priority claim(s) or which is cited to establish the publication date of another citation or other special reason (as specified)
- \*O\* document referring to an oral disclosure, use, exhibition or other means
- \*P\* document published prior to the international filing date but later than the priority date claimed

- \*T\* later document published after the international filing date or priority date and not in conflict with the application but cited to understand the principle or theory underlying the invention
- \*X\* document of particular relevance; the claimed invention cannot be considered novel or cannot be considered to involve an inventive step when the document is taken alone
- \*Y\* document of particular relevance; the claimed invention cannot be considered to involve an inventive step when the document is combined with one or more other such documents, such combination being obvious to a person skilled in the art.
- \*&\* document member of the same patent family

Date of the actual completion of the international search

22 November 1995

Date of mailing of the international search report

14. 12. 95

Name and mailing address of the ISA  
European Patent Office, P.B. 5818 Patentlaan 2  
NL - 2280 HV Rijswijk  
Tel. (+ 31-70) 340-2040, Tx. 31 651 epo nl,  
Fax: (+ 31-70) 340-3016

Authorized officer

Fuchs, P

INTERNATIONAL SEARCH REPORT

International Application No  
PCT/US 95/11173

C.(Continuation) DOCUMENTS CONSIDERED TO BE RELEVANT		
Category *	Citation of document, with indication, where appropriate, of the relevant passages	Relevant to claim No.
Y	<p>CABLE TV SESSIONS, MONTREUX, JUNE 10 - 15, 1993, no. SYMP. 18, 11 June 1993 POSTES;TELEPHONES ET TELEGRAPHES SUISSES, pages 571-586, XP 000379382 BRUGLIERA V 'DIGITAL ON-SCREEN DISPLAY A NEW TECHNOLOGY FOR THE CONSUMER INTERFACE' see page 578, line 20 - page 586, line 48; figure 6</p> <p style="text-align: center;">---</p>	<p>1,2,5-8, 11,12, 14-16,18</p>
A	<p>EP,A,0 497 235 (EDICO SRL) 5 August 1992 see abstract see column 5, line 17 - line 21; figure 4</p> <p style="text-align: center;">---</p>	<p>1,2,14</p>
A	<p>EP,A,0 488 379 (MATSUSHITA ELECTRIC IND CO LTD) 3 June 1992 see abstract see column 3, line 23 - column 4, line 16 see column 7, line 26 - line 58; figure 3A</p> <p style="text-align: center;">---</p>	<p>1,2,14</p>
A	<p>RUNDFUNKTECHNISCHE MITTEILUNGEN, vol. 30, no. 1, January 1986 - February 1986 NORDERSTEDT (DE), pages 1-8, KARL-UULRICH OBERLIES ET AL. 'VPS-ANZEIGE UND ÜBERWACHUNGSGERÄT' see the whole document</p> <p style="text-align: center;">---</p>	<p>1,2,14</p>
A	<p>EP,A,0 447 968 (RCA LICENSING CORP) 25 September 1991 see abstract see column 5, line 4 - line 26; figures 5A,5B</p> <p style="text-align: center;">-----</p>	<p>1,2,5-8, 10,13-18</p>

# INTERNATIONAL SEARCH REPORT

Information on patent family members

International Application No  
PCT/US 95/11173

Patent document cited in search report	Publication date	Patent family member(s)	Publication date
EP-A-0444496	04-09-91	JP-A- 3253189 DE-D- 69102718 DE-T- 69102718	12-11-91 11-08-94 24-11-94
-----			
GB-A-2217144	18-10-89	JP-A- 1246978 DE-A, C 3910052 US-A- 5109279	02-10-89 12-10-89 28-04-92
-----			
EP-A-0497235	05-08-92	NONE	
-----			
EP-A-0488379	03-06-92	JP-A- 4200082 US-A- 5390027 US-A- 5260788	21-07-92 14-02-95 09-11-93
-----			
EP-A-0447968	25-09-91	US-A- 5343300	30-08-94
-----			