

No. 641,471.

Patented Jan. 16, 1900.

C. F. SCHEEL.  
DOOR CATCH.

(Application filed Mar. 21, 1899.)

(No Model.)

2 Sheets—Sheet 1.

FIG-6-

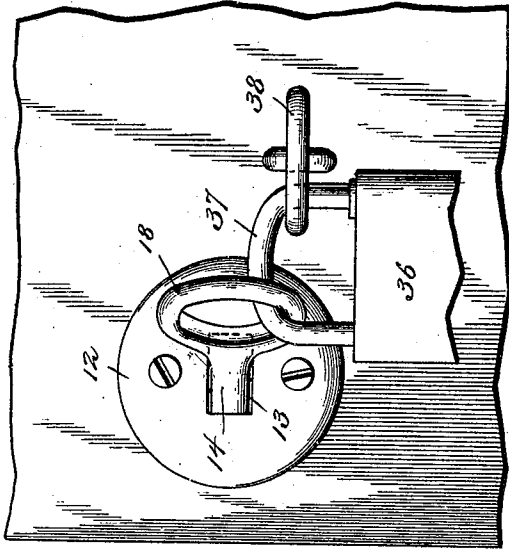

FIG-5-

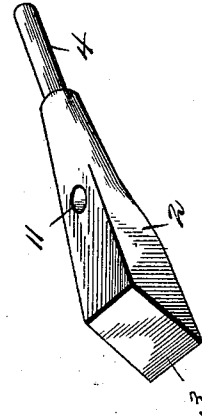

FIG-4-

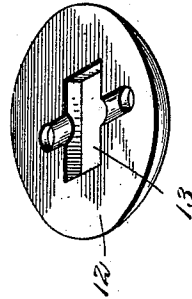

FIG-1-

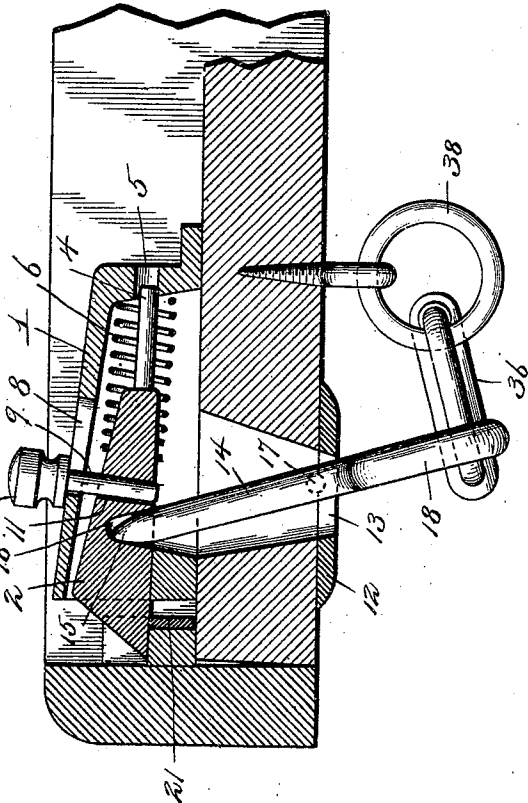
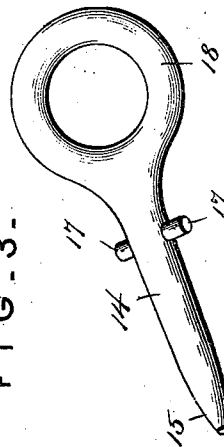

FIG-3-



Witnesses

*Harry L. Amer.*  
*A. A. Fran.*

Inventor

*Christian F. Scheel.*

*By V. K. Stockbridge,*

Attorney

C. F. SCHEEL.  
DOOR CATCH.

(Application filed Mar. 21, 1899.)

(No Model.)

2 Sheets—Sheet 2.

FIG. 2.-

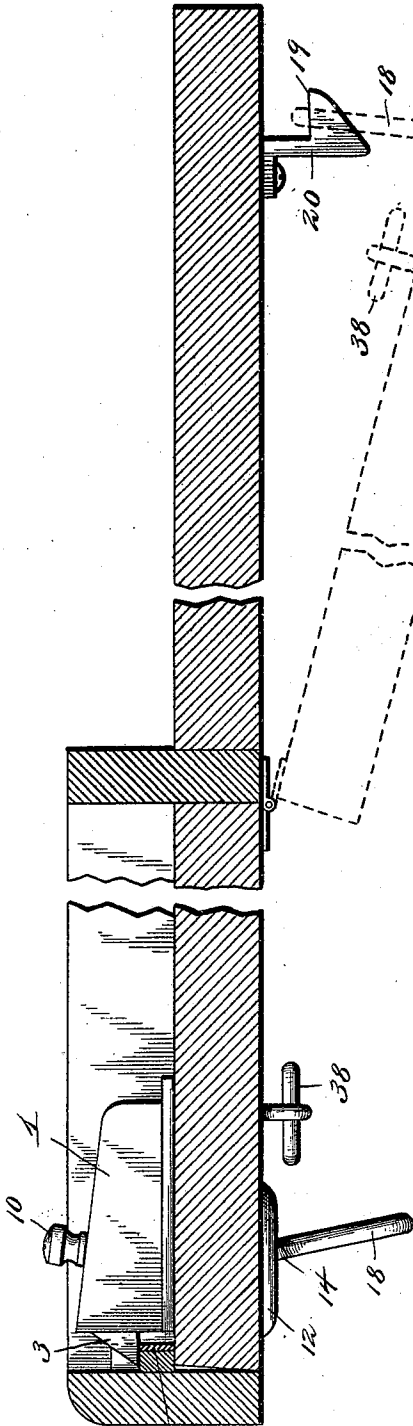

FIG. 7.-

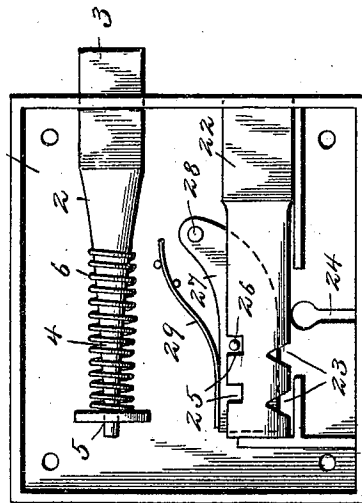
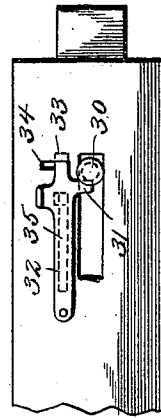

FIG. 6.-



Witnesses

Harry L. Amer.  
A. C. Nau.

Inventor  
Christian F. Scheel.  
By V. D. Stockbridge,  
Attorney

# UNITED STATES PATENT OFFICE.

CHRISTIAN FRIEDRICH SCHEEL, OF WESTERN, NEBRASKA.

## DOOR-CATCH.

SPECIFICATION forming part of Letters Patent No. 641,471, dated January 16, 1900.

Application filed March 21, 1899. Serial No. 709,956. (No model.)

*To all whom it may concern:*

Be it known that I, CHRISTIAN FRIEDRICH SCHEEL, a citizen of the United States, residing at Western, in the county of Saline and State of Nebraska, have invented certain new and useful Improvements in Door-Catches; and I do hereby declare the following to be a full, clear, and exact description of the invention, such as will enable others skilled in the art to which it appertains to make and use the same.

This invention relates to door-catches, and while the same will be described as particularly applicable to doors it will be apparent as the description proceeds that the catch may be applied to window-blinds, storm-blinds, and various other devices swung on hinges and which it is desirable to hold or fasten both in their closed and open positions.

The object of the present invention is to provide a latch-bolt or catch which may be operated from both sides of the door, two independent keepers being used in connection therewith and the bolt being actuated by a single spring, which also serves to hold the keeper-engaging portions of the device in engagement with the keepers until the tension of the spring is overcome by the operator.

It is also the object of the invention to make the outer latch-operating device removable, so as to prevent unauthorized entrance.

The detailed object and advantages of the invention will appear in the course of the subjoined description.

The invention consists in certain novel features and details of construction and arrangement of parts, as hereinafter fully described, illustrated in the drawings, and incorporated in the claims.

In the accompanying drawings, Figure 1 is a sectional view through a door and jamb, showing the improved latch applied thereto. Fig. 2 is a similar view showing the door closed and latched in full lines and also illustrating the manner of fastening the door when open. Fig. 3 is a detail perspective view of the detachable pin or lever. Fig. 4 is a similar view of the escutcheon-plate. Fig. 5 is a similar view of the latch-bolt. Fig. 6 is a detail elevation showing the manner of locking the pin or lever by means of a padlock. Fig. 7 is an elevation of the lock-case with the adjacent

face-plate removed, showing the use in connection with a latch-bolt of the locking-bolt and operating mechanism. Fig. 8 is a detail elevation showing the latch for coöperation with the locking-bolt.

Similar numerals of reference designate corresponding parts in all the figures of the drawings.

The latch proper comprises a casing 1, which is made tapering or wedge-shaped, as shown, and in which is mounted a latch-bolt 2, also made tapering in form and provided with a beveled nose 3. The heel end of the bolt 2 is reduced to form a guiding-shank 4, which works through an opening 5 in the rear end of the latch-casing, thereby serving to steady the movements of the bolt. Surrounding the bolt within the casing is a coil-spring 6, which normally projects the bolt outward into engagement with its keeper, said spring bearing against the inner surface of the casing.

The casing 1 is provided in its outer side with a longitudinal slot 8, in which works the shank 9 of the bolt-operating knob 10, the shank of the knob being received in a hole or recess 11 in the bolt. This construction enables the bolt to be slid backward from the inside of the door, the casing as a whole being secured to the inner face of the door.

Upon the opposite side of the door is secured an escutcheon-plate 12, having an oblong rectangular slot 13 therein. 14 designates a pin or lever which is insertible through the opening in the escutcheon. The pin 14 has a pointed end 15, which when the pin is in position enters and works in a socket 16 in the latch-bolt. At a point near its middle the pin 14 is provided with oppositely-located and laterally-projecting studs or trunnions 17, the distance between the outer extremities of which is slightly less than the length of the slot in the escutcheon-plate. At its outer end the pin or lever 14 is provided with a finger-loop 18, by which the pin or lever may be rocked. The loop at the outer end of the lever is adapted to engage behind the shoulder 19 of the bevel-nosed keeper or catch 20, which in practice is secured to the wall of a building at a point where it may be engaged by the looped end of the pin or lever 14 when the door is thrown entirely open. When the door is closed, the end of the bolt engages

a keeper 21 of any usual or preferred construction.

From the foregoing description it will be seen that by rocking the pin or lever 14 the  
 5 spring-actuated latch-bolt may be thrown backward for opening the door, and of course the bolt may be thrown back from the inside of the door by means of the bolt-operating knob. Thus the bolt may be operated from  
 10 both sides of the door while the pin or lever 14 is in position. The pin or lever 14 is rounded in cross-section, adapting it to be rotated on its longitudinal axis for permitting its insertion and withdrawal without removing  
 15 or otherwise disturbing the escutcheon and is inserted through the escutcheon-plate by arranging the studs or trunnions thereof lengthwise in said slot. At the same time the point of the pin is thrust into engagement  
 20 with the bolt, and thereafter the pin or lever is given a quarter-turn, which causes the studs or trunnions thereon to become engaged behind or against the inner surface of the escutcheon-plate, thereby preventing the accidental removal of said pin or lever. The studs  
 25 or trunnions form the pivots on which the part 14 is rocked for operating the latch-bolt and also for enabling the looped end of said lever to be engaged with and disengaged from the keeper or catch on the wall at one side of  
 30 the door. When it is desired to prevent entrance from the outside of the door, the part 14 is detached and removed in a manner readily apparent from the foregoing description.  
 35 In some cases it is desirable to employ in addition to the latch-bolt a locking-bolt, and in such event a larger casing is employed, as shown at 21 in Fig. 7. In this casing, and preferably below the latch-bolt hereinabove  
 40 described, is arranged a reciprocating lock-bolt 22, which is mounted in suitable guides and provided with notches 23 to receive a key inserted through a keyhole 24. The shank of the bolt 22 is also provided on its upper edge  
 45 with notches 25 to be engaged by a pin 26 on a tumbler 27, pivoted at 28 within the lock-case and held depressed and in engagement with the lock-bolt by means of a leaf-spring 29. The lower edge of the tumbler extends  
 50 across the notches 23, and as the key enters one of the notches the bit of the key operates to lift the tumbler and disengage the pin 26 from the notches 25, thus allowing the bolt to be moved back and forth and adapting the  
 55 bolt to be held locked by the tumbler either in its inward or outward position in a manner readily understood. The bolt 22 is also provided with a laterally-projecting pin 30, which is engaged by a pendent lug 31 or a  
 60 pivoted latch 32, the free end of which passes through a vertical slot 34 in the casing, whereby it may be operated from the exterior of the casing. Bearing against the latch 32 is a

spring 35, which serves to hold the latch either in its upward or downward position. When  
 65 the latch 32 is moved downward, it is impossible to operate the bolt by means of a key.

In Fig. 6 I have shown a method of locking the pin or lever 14 by means of a padlock 36, the shank or bail 37 of which passes through  
 70 the loop 18 of the lever and also through an eye or ring 38, fastened to the door at a suitable point, as shown in Figs. 1 and 6.

It is within the scope of this invention to construct the lock in the form of a mortise-  
 75 lock and to project the operating-lever, so that it can be worked from each side of the door. The catches and locks will be manufactured in several different sizes suitable for cupboards, screens, barn-doors, &c., and, if  
 80 preferred, the articles may be stamped from steel or other suitable metal.

Having thus described the invention, what is claimed as new, and desired to be secured by Letters Patent, is—

1. The combination with a spring-actuated  
 85 bolt having an operating-knob projecting from one side of the casing and provided on its opposite side with a socket, of a pivoted pin or lever projecting from the opposite side  
 90 of the casing and having its inner end removably fitted in the socket, said pin or lever being adapted to be rotated on its longitudinal axis, and an escutcheon-plate permitting the insertion and withdrawal of said pin without  
 95 removing the escutcheon and having oppositely-disposed notches on its inner face adapted to engage trunnions on the pin when the latter is in operative position, substantially as and for the purpose described.

2. The combination with a spring-actuated bolt, bolt-operating knob and casing, of an  
 100 escutcheon-plate having an oblong slot and with oppositely-disposed notches on its inner face, and a rounded pin adapted to be rotated  
 105 on its longitudinal axis for permitting its insertion and removal without removing the escutcheon, said pin having a pointed inner end adapted to engage a socket in the bolt and provided with a loop on its projecting outer  
 110 end and oppositely-disposed studs or trunnions at a point intermediate said ends adapted to engage the notches in the escutcheon, and an eye or ring on the door adjacent to the looped end of the pin or lever, which,  
 115 together with said end of the pin or lever is adapted to receive a padlock for locking the bolt against movement from either side of the door, substantially as described.

In testimony whereof I affix my signature in  
 120 presence of two witnesses.

CHRISTIAN FRIEDRICH SCHEEL.

Witnesses:

A. R. SCOTT,  
 HENRY KELLER.