



(12) **United States Design Patent**
Dai et al.

(10) **Patent No.:** **US D734,284 S**
(45) **Date of Patent:** **** Jul. 14, 2015**

(54) **TELEVISION**

(71) Applicant: **HON HAI PRECISION INDUSTRY CO., LTD.**, New Taipei (TW)

(72) Inventors: **Wei-Fang Dai**, Shenzhen (CN);
Ching-Hua Tsai, New Taipei (TW);
Jen-Hui Oh, New Taipei (TW);
Wen-Pin Wang, New Taipei (TW);
Fang-Yuan Shyu, New Taipei (TW)

(73) Assignee: **HON HAI PRECISION INDUSTRY CO., LTD.**, New Taipei (TW)

(**) Term: **14 Years**

(21) Appl. No.: **29/512,508**

(22) Filed: **Dec. 19, 2014**

(30) **Foreign Application Priority Data**

Nov. 19, 2014 (CN) 2014 3 0458305

(51) **LOC (10) Cl.** **14-03**

(52) **U.S. Cl.**
USPC **D14/126**

(58) **Field of Classification Search**

USPC D14/125-134, 239, 371, 136, 374-377,
D14/440, 450, 448, 336, 342, 159; 312/7.2;
348/836, 838, 180, 184, 325, 739;
248/917-924, 465; 345/104, 133, 156,
345/168, 87, 173; D21/329, 515, 577, 622,
D21/333, 433, 448, 452, 450, 331, 505;
D10/15, 26; 446/484, 175, 356;
D6/477, 479, 300; D24/185; D34/14
CPC ... G06F 1/1601; G06F 1/1643; H05K 5/0004;
H05K 5/0017; H05K 5/02; H05K 5/0217

See application file for complete search history.

(56) **References Cited**

U.S. PATENT DOCUMENTS

D670,257 S * 11/2012 Yang et al. D14/126
D691,102 S * 10/2013 Park et al. D14/126
D719,539 S * 12/2014 Ryu et al. D14/126
D721,049 S * 1/2015 Lee D14/126

* cited by examiner

Primary Examiner — Raphael Barkai

(74) *Attorney, Agent, or Firm* — Novak Druce Connolly
Bove + Quigg LLP

(57) **CLAIM**

The design for a television, as shown and as described.

DESCRIPTION

FIG. 1 is a perspective view of a first embodiment of a television showing our design;

FIG. 2 is a front elevational view thereof;

FIG. 3 is a rear elevational view thereof;

FIG. 4 is a left side elevational view thereof;

FIG. 5 is a right side elevational view thereof;

FIG. 6 is a top plan view thereof;

FIG. 7 is a bottom plan view thereof;

FIG. 8 is a perspective view of a second embodiment of a television showing our design;

FIG. 9 is a front elevational view thereof;

FIG. 10 is a rear elevational view thereof;

FIG. 11 is a left side elevational view thereof;

FIG. 12 is a right side elevational view thereof;

FIG. 13 is a top plan view thereof; and,

FIG. 14 is a bottom plan view thereof.

The broken lines in the drawings are employed to show unclaimed portions of the television, and form no part of the claimed design.

1 Claim, 14 Drawing Sheets

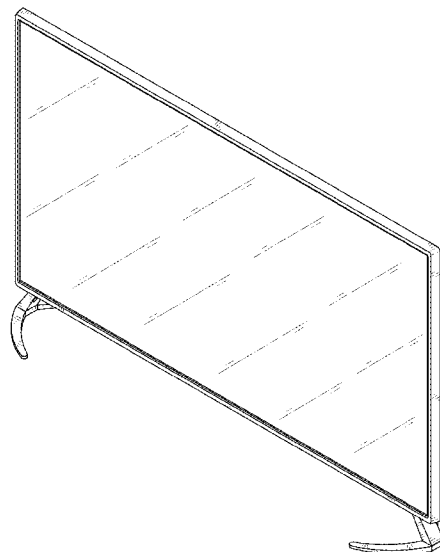

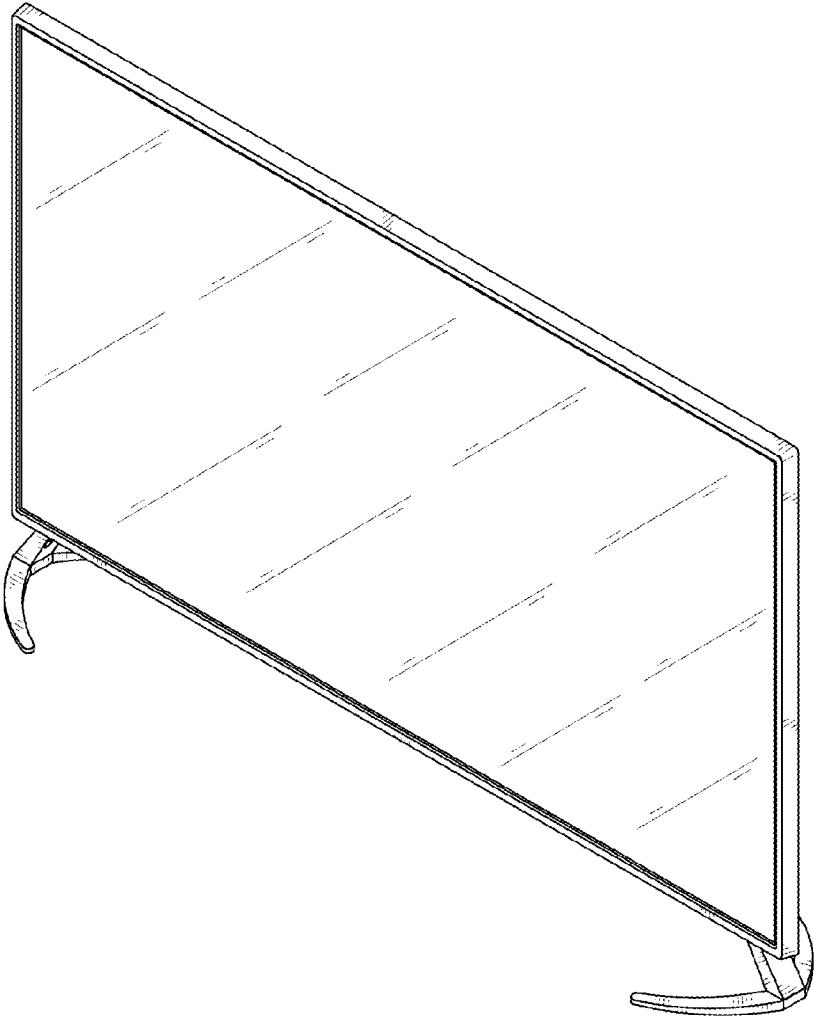

FIG. 1

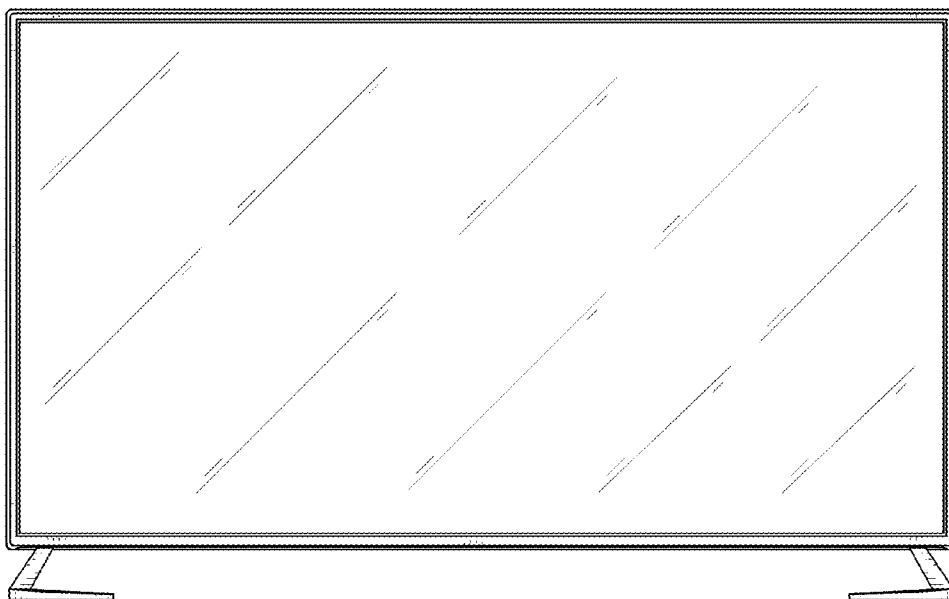

FIG. 2

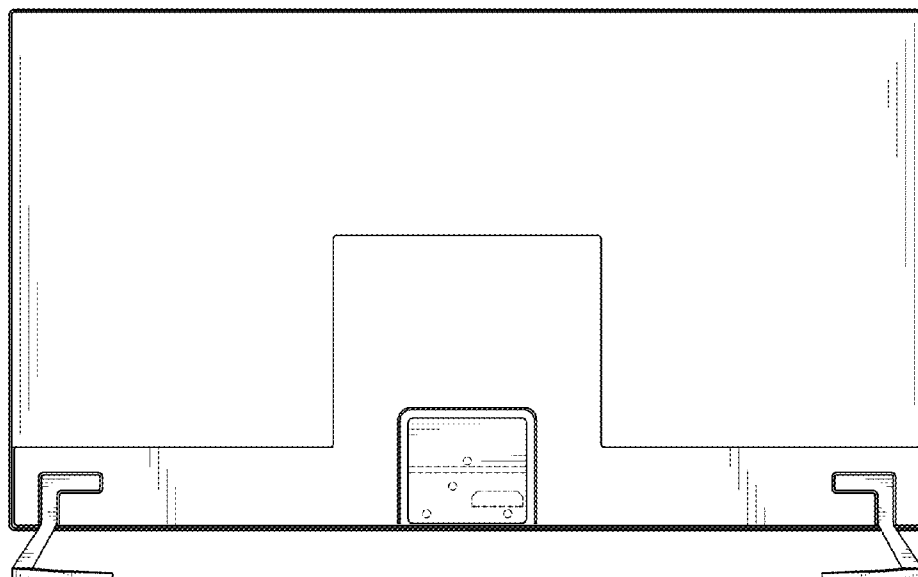

FIG. 3

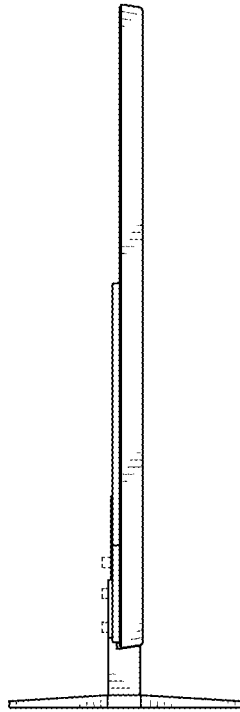

FIG. 4

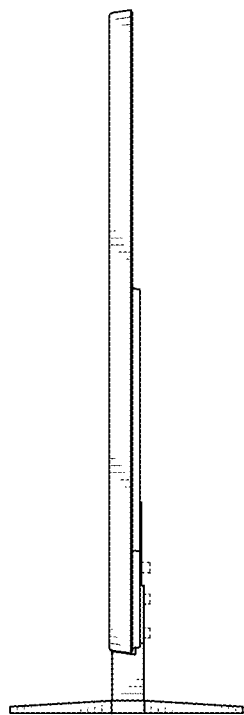

FIG. 5

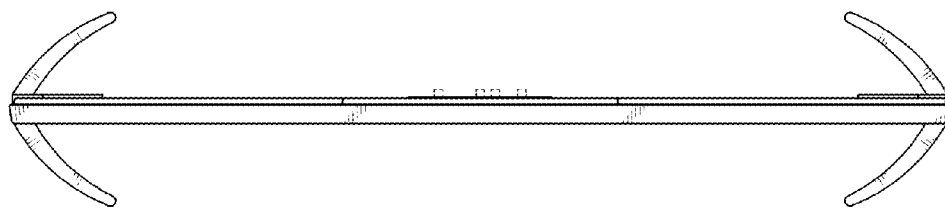

FIG. 6

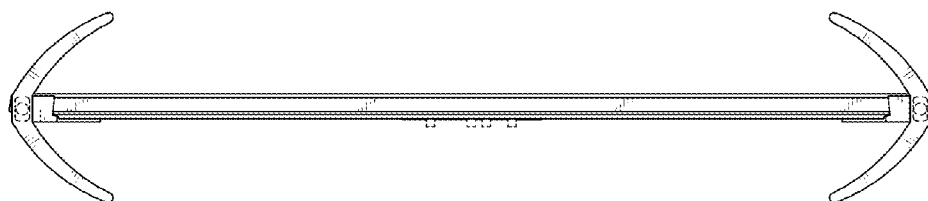

FIG. 7

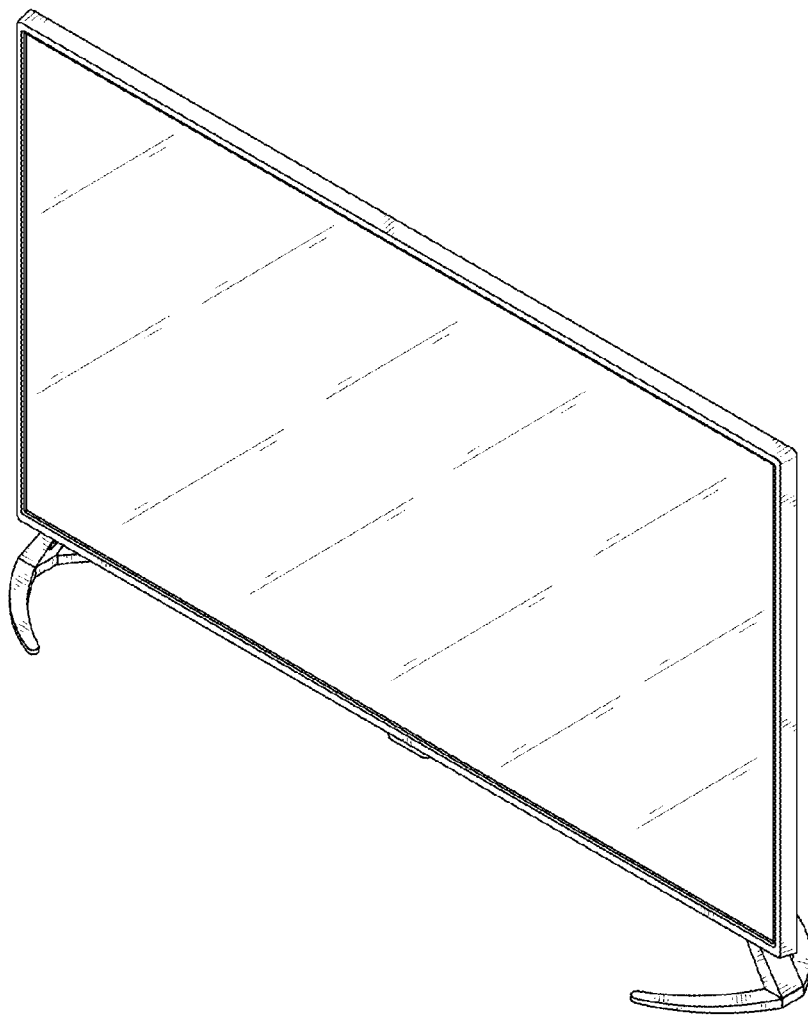

FIG. 8

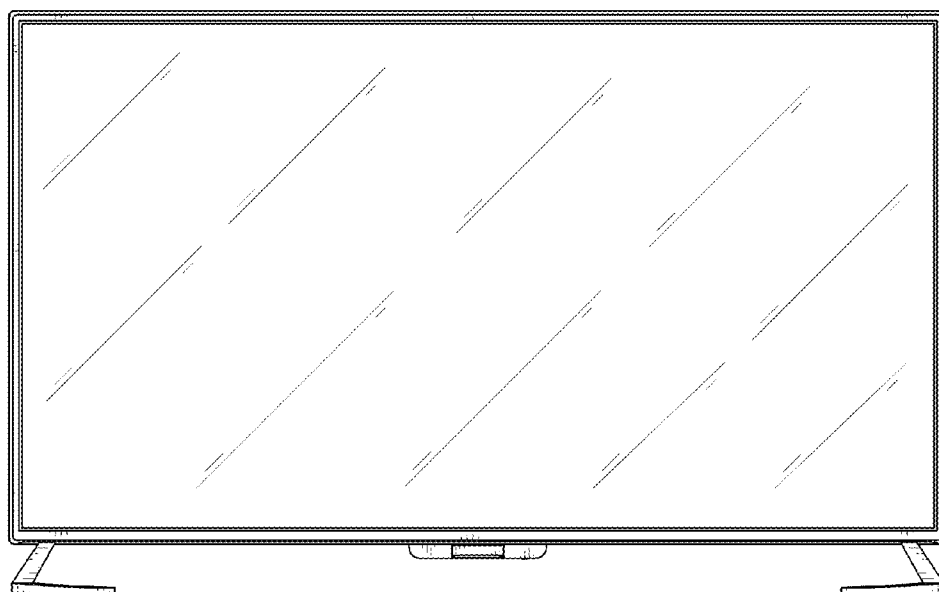

FIG. 9

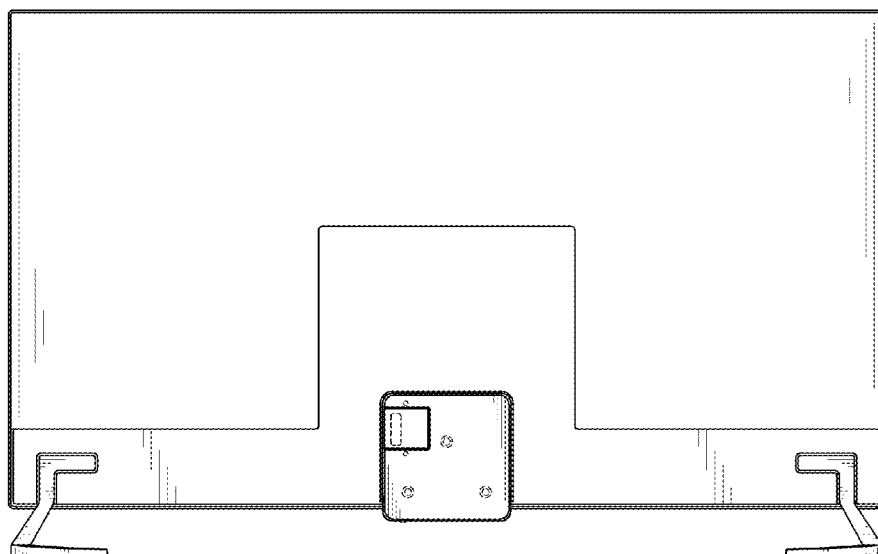

FIG. 10

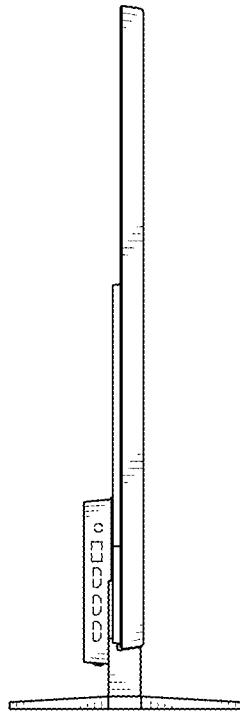

FIG. 11

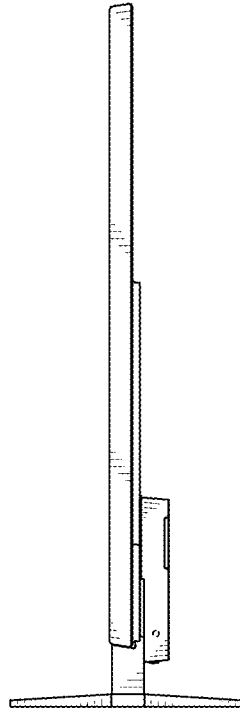

FIG. 12

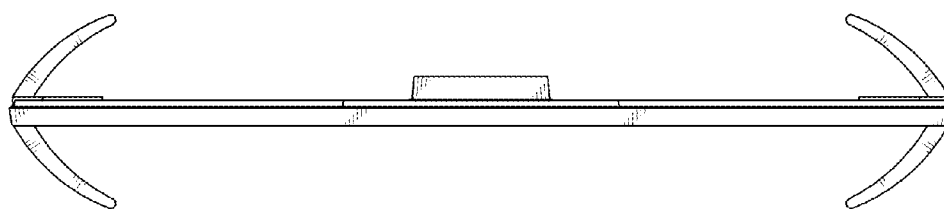

FIG. 13

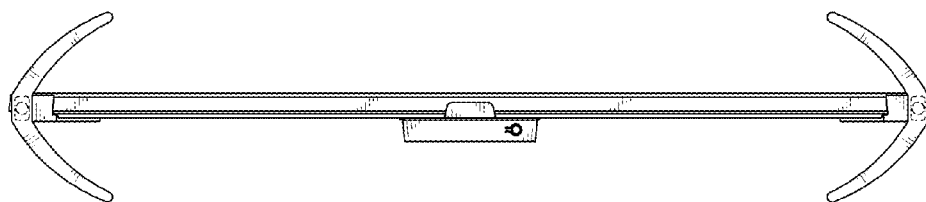

FIG. 14