



US00D722658S

(12) **United States Design Patent**  
**Marschall et al.**

(10) **Patent No.:** **US D722,658 S**

(45) **Date of Patent:** **\*\* Feb. 17, 2015**

(54) **INTERCONNECTABLE BUILDING BLOCK  
CONTAINER CAPABLE OF STORING ITEMS**

(71) Applicant: **ChangeBox IP Holdings, LLC**, New Hope, PA (US)

(72) Inventors: **Christopher Mark Marschall**, New Hope, PA (US); **Paul Dowd**, Scarsdale, NY (US); **Christopher Miller**, Bronxville, NY (US); **Robert Marvin**, Farmington, CT (US)

(73) Assignee: **ChangeBox IP Holdings, LLC**, New Hope, PA (US)

(\*\*) Term: **14 Years**

(21) Appl. No.: **29/485,096**

(22) Filed: **Mar. 14, 2014**

(51) **LOC (10) Cl.** ..... **21-01**

(52) **U.S. Cl.**  
USPC ..... **D21/499**

(58) **Field of Classification Search**  
USPC ..... D21/333, 373, 386, 389, 404, 468, 470, D21/471, 475, 484-505; 446/69, 85, 446/102-128; 434/167, 208, 259, 403; 273/153, 156, 160; D3/304, 314; D24/101; D9/640; 220/23.4; 40/720  
See application file for complete search history.

(56) **References Cited**

**U.S. PATENT DOCUMENTS**

1,465,637	A *	8/1923	Goss	434/403
1,895,611	A *	1/1933	Doak	434/403
D141,340	S *	5/1945	Greenfield	D21/499
2,440,205	A *	4/1948	McLain	434/167
3,138,398	A	6/1964	Silverman	
3,194,426	A	7/1965	Brown, Jr.	
3,391,824	A	7/1968	Wiseman	
3,703,045	A *	11/1972	Nyman	40/720
4,003,144	A *	1/1977	Maddestra et al.	434/403

D249,230	S	9/1978	Van Der Veken	
D249,231	S	9/1978	Van der Veken	
D252,909	S	9/1979	Bayly	
D252,910	S	9/1979	Bayly	
4,624,383	A	11/1986	Moore	
4,722,473	A	2/1988	Sandrini et al.	
5,310,071	A *	5/1994	Rivlin et al.	220/23.4
D369,100	S *	4/1996	Johnson	D21/499
5,503,296	A	4/1996	DiBaggio	
D371,281	S	7/1996	Credle, Jr.	
D377,887	S	2/1997	Credle, Jr.	
D391,999	S *	3/1998	Chininis	D21/475

(Continued)

**FOREIGN PATENT DOCUMENTS**

WO	9308888	A1	5/1993
WO	9831607	A1	7/1998
WO	2013035079	A1	3/2013

**OTHER PUBLICATIONS**

International Search Report and Written Opinion for PCT Application No. PCT/US2014/029904, prepared by the European Patent Office, mailing date Jun. 16, 2014, 9 pp.

*Primary Examiner* — Cynthia M Chin

(74) *Attorney, Agent, or Firm* — Rita C. Chipperson, Esq.; Chipperson Law Group, P.C.

(57) **CLAIM**

The ornamental design for an interconnectable building block container capable of storing items, as shown and described.

**DESCRIPTION**

FIG. 1 is a perspective view of an interconnectable building block container capable of storing items;  
FIG. 2 is a left side view thereof;  
FIG. 3 is a right side view thereof;  
FIG. 4 is a front elevational view thereof;  
FIG. 5 is a rear elevational view thereof;  
FIG. 6 is a top plan view thereof; and,  
FIG. 7 is a bottom plan view thereof.

**1 Claim, 4 Drawing Sheets**

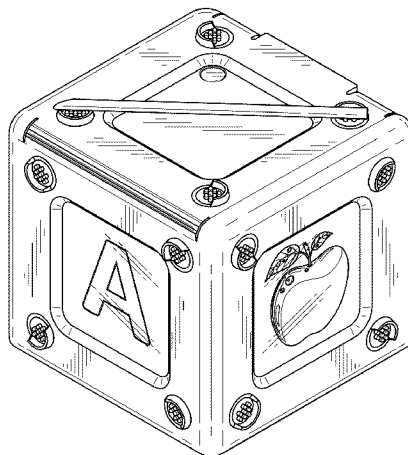

(56)

**References Cited**

U.S. PATENT DOCUMENTS

5,782,358	A *	7/1998	Walker	220/23.4	D509,858	S *	9/2005	May et al.	D21/499
D412,646	S	8/1999	Credle, Jr.		D515,940	S	2/2006	Kratko	
D412,662	S	8/1999	Giskeodegaard et al.		7,175,498	B2	2/2007	Garpow et al.	
D421,335	S *	3/2000	Linard	D3/314	D565,527	S *	4/2008	Riggs	D21/499
D437,366	S *	2/2001	Stemmler	D21/499	D610,212	S *	2/2010	Pedersen	D21/499
6,256,914	B1 *	7/2001	Yeh	40/720	D616,044	S *	5/2010	Tervo	D21/499
D446,826	S *	8/2001	Dunn et al.	D21/398	D616,045	S *	5/2010	Tervo	D21/499
6,506,091	B1	1/2003	Garpow		D695,350	S *	12/2013	Doleshal	D21/373
D481,767	S *	11/2003	May et al.	D21/499	D698,869	S *	2/2014	Strzelewicz et al.	D21/499
					2008/0217340	A1	9/2008	Jager	
					2010/0170897	A1	7/2010	Gold et al.	
					2011/0089070	A1	4/2011	Resnick	

\* cited by examiner

FIG. 1

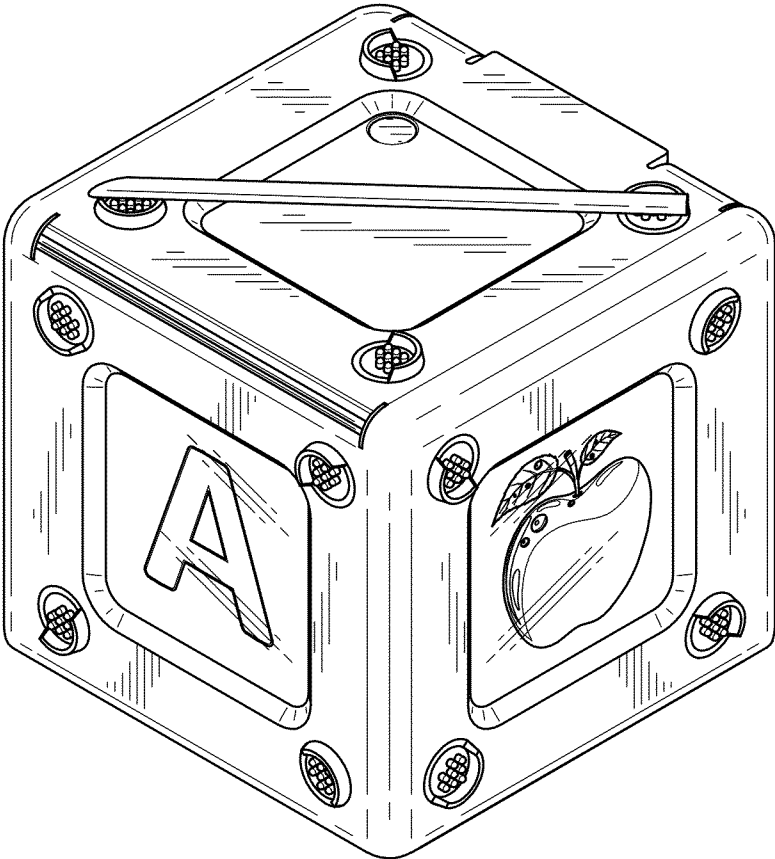

FIG. 2

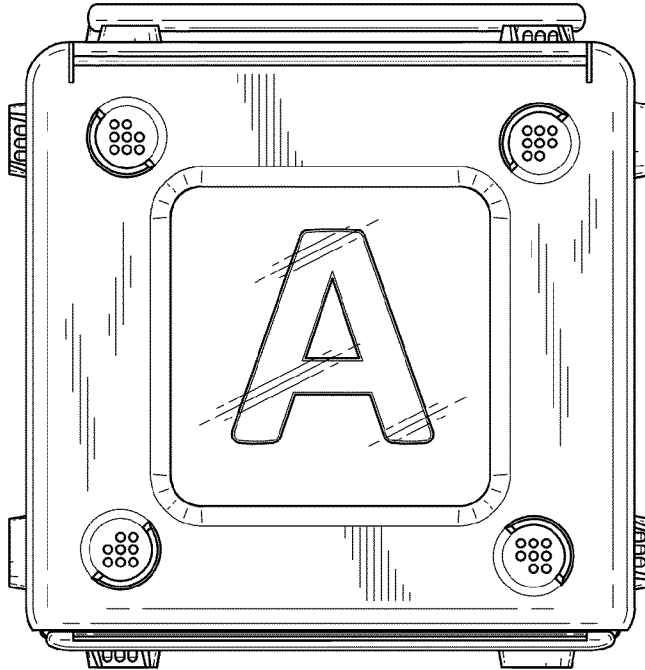

FIG. 3

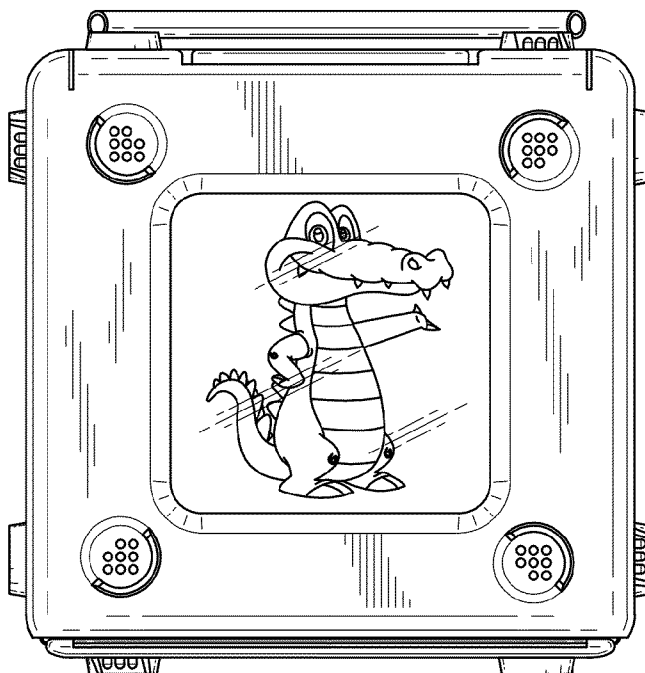

FIG. 4

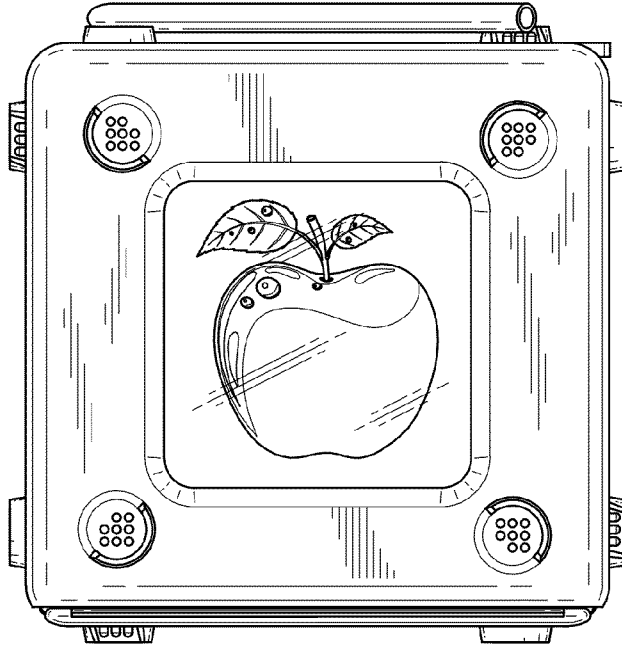

FIG. 5

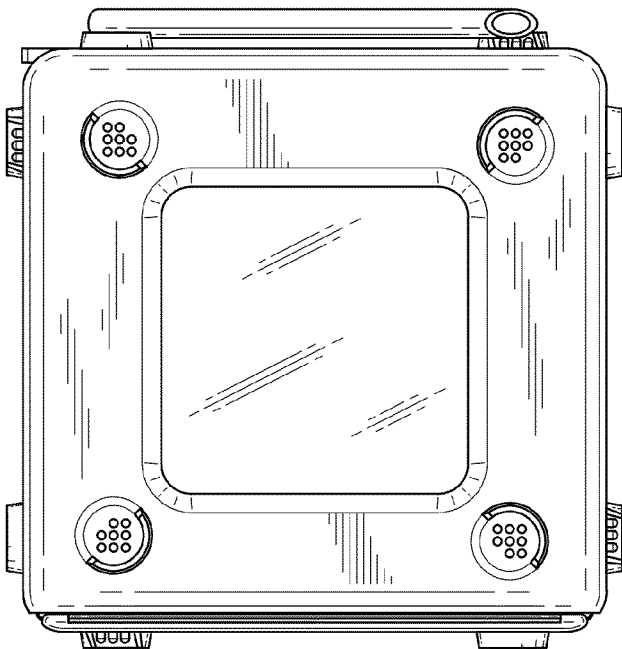

FIG. 6

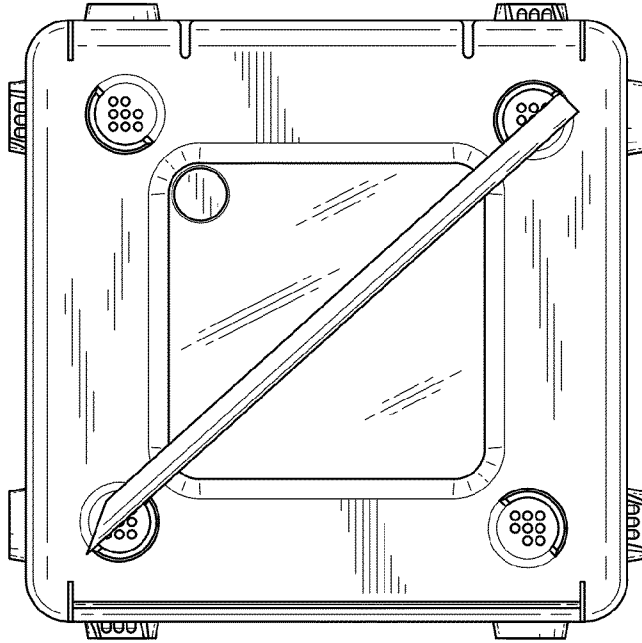

FIG. 7

