



(22) Date de dépôt/Filing Date: 2015/05/21
(41) Mise à la disp. pub./Open to Public Insp.: 2016/07/27
(45) Date de délivrance/Issue Date: 2021/04/27
(62) Demande originale/Original Application: 2 892 107
(30) Priorité/Priority: 2015/01/27 (KR10-2015-0012878)

(51) Cl.Int./Int.Cl. *H04L 27/38* (2006.01),
H03M 13/11 (2006.01), *H03M 13/27* (2006.01),
H04L 1/22 (2006.01)

(72) Inventeurs/Inventors:
PARK, SUNG-IK, KR;
KWON, SUN-HYOUNG, KR;
LIM, BO-MI, KR;
LEE, JAE-YOUNG, KR;
KIM, HEUNG-MOOK, KR;
HUR, NAM-HO, KR

(73) Propriétaire/Owner:
ELECTRONICS AND TELECOMMUNICATIONS
RESEARCH INSTITUTE, KR

(74) Agent: SMART & BIGGAR LLP

(54) Titre : ENTRELACEUR DE BITS POUR MOT CODE A CONTROLE DE PARITE FAIBLE DENSITE AYANT UNE LONGUEUR DE 16200 BITS ET UN TAUX DE CODE DE 2/15 ET UN MAPPAGE A 256 SYMBOLES, ET PROCEDE A ENTRELACEMENT DE BITS UTILISANT CELUI-C

(54) Title: BIT INTERLEAVER FOR LOW-DENSITY PARITY CHECK CODEWORD HAVING LENGTH OF 16200 AND CODE RATE OF 2/15 AND 256-SYMBOL MAPPING, AND BIT INTERLEAVING METHOD USING SAME

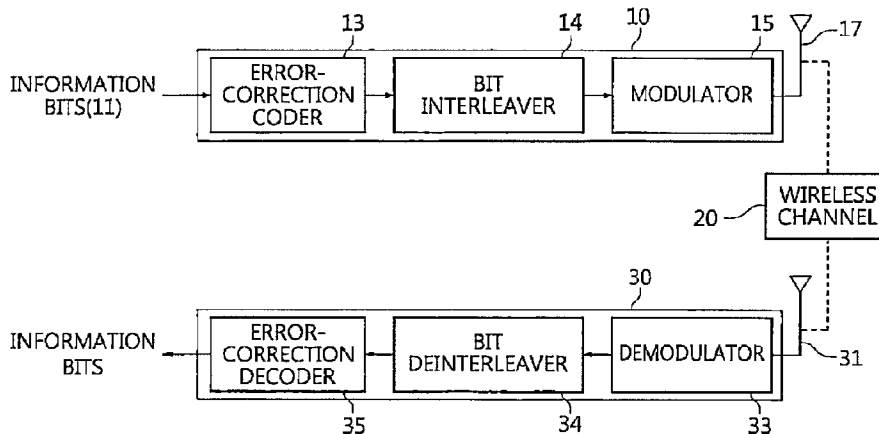

(57) **Abrégé/Abstract:**

A bit interleaver, a bit-interleaved coded modulation (BICM) device and a bit interleaving method are disclosed herein. The bit interleaver includes a first memory, a processor, and a second memory. The first memory stores a low-density parity check (LDPC) codeword having a length of 16200 and a code rate of 2/15. The processor generates an interleaved codeword by interleaving the LDPC codeword on a bit group basis. The size of the bit group corresponds to a parallel factor of the LDPC codeword. The second memory provides the interleaved codeword to a modulator for 256-symbol mapping.

ABSTRACT

A bit interleaver, a bit-interleaved coded modulation (BICM) device and a bit interleaving method are disclosed herein. The bit interleaver includes a first memory, a processor, and a second memory. The first memory stores a low-density parity check (LDPC) codeword having a length of 16200 and a code rate of 2/15. The processor generates an interleaved codeword by interleaving the LDPC codeword on a bit group basis. The size of the bit group corresponds to a parallel factor of the LDPC codeword. The second memory provides the interleaved codeword to a modulator for 256-symbol mapping.

BIT INTERLEAVER FOR LOW-DENSITY PARITY CHECK CODEWORD HAVING
LENGTH OF 16200 AND CODE RATE OF 2/15 AND 256-SYMBOL MAPPING, AND
BIT INTERLEAVING METHOD USING SAME

CROSS-REFERENCE TO RELATED APPLICATIONS

[0001] This application is a divisional of Canadian Patent Application No. 2,892,107 filed on May 21, 2015. This application claims the benefit of Korean Patent Application No. 10-2015-0012878, filed January 27, 2015.

BACKGROUND

1. Technical Field

[0002] The present disclosure relates generally to an interleaver and, more particularly, to a bit interleaver that is capable of distributing burst errors occurring in a digital broadcast channel.

2. Description of the Related Art

[0003] Bit-Interleaved Coded Modulation (BICM) is bandwidth-efficient transmission technology, and is implemented in such a manner that an error-correction coder, a bit-by-bit interleaver and a high-order modulator are combined with one another.

[0004] BICM can provide excellent performance using a simple structure because it uses a low-density parity check (LDPC) coder or a Turbo coder as the error-correction coder. Furthermore, BICM can provide high-level flexibility because it can select modulation order and the length and code rate of an error correction code in various forms. Due to these advantages, BICM has been used in broadcasting standards, such as DVB-T2 and DVB-NGH, and has a strong possibility of being used in other next-generation broadcasting systems.

[0005] However, in spite of those advantages, BICM suffers from the rapid degradation of performance unless burst errors occurring in a channel are appropriately distributed via the bit-by-bit interleaver. Accordingly, the bit-by-bit interleaver used in BICM should be designed to be optimized for the modulation order or the length and code rate of the error correction code.

SUMMARY

[0006] At least one embodiment of the present invention is directed to the provision of an intra-BICM bit interleaver that can effectively distribute burst errors occurring in a broadcasting system channel.

[0007] At least one embodiment of the present invention is directed to the provision of a bit interleaver that is optimized for an LDPC coder having a length of 16200 and a code rate of 2/15 and a modulator performing 256-symbol mapping and, thus, can be applied to next-generation broadcasting systems, such as ATSC 3.0.

[0008] In accordance with an aspect of the present invention, there is provided a bit interleaver, including a first memory configured to store a low-density parity check (LDPC) codeword having a length of 16200 and a code rate of 2/15; a processor configured to generate an interleaved codeword by interleaving the LDPC codeword on a bit group basis, the size of the bit group corresponding to a parallel factor of the LDPC codeword; and a second memory configured to provide the interleaved codeword to a modulator for 256-symbol mapping.

[0009] The 256-symbol mapping may be NUC (Non-Uniform Constellation) symbol mapping corresponding to 256 constellations (symbols).

[0010] The parallel factor may be 360, and each of the bit groups may include 360 bits.

[0011] The LDPC codeword may be represented by $(u_0, u_1, \dots, u_{N_{ldpc}-1})$ (where N_{ldpc} is 16200), and may be divided into 45 bit groups each including 360 bits, as in the following equation:

$$X_j = \{u_k \mid 360 \times j \leq k < 360 \times (j+1), \quad 0 \leq k < N_{ldpc}\} \text{ for } 0 \leq j < N_{group}$$

where X_j is an j -th bit group, N_{ldpc} is 16200, and N_{group} is 45.

[0012] The interleaving may be performed using the following equation using permutation order:

$$Y_j = X_{\pi(j)} \quad 0 \leq j \leq N_{group}$$

where X_j is the j -th bit group, Y_j is an interleaved j -th bit group, and $\pi(j)$ is a permutation order for bit group-based interleaving (bit group-unit interleaving).

[0013] The permutation order may correspond to an interleaving sequence represented by the following equation:

interleaving sequence

= {31 3 38 9 34 6 4 18 15 1 21 19 42 20 12 13 30 26 14 2 10 35 28 44 23 11 22 16 29
40 27 37 25 41 5 43 39 36 7 24 32 17 33 8 0}

[0014] In accordance with another aspect of the present invention, there is provided a bit interleaving method, including storing an LDPC codeword having a length of 16200 and a code rate of 2/15; generating an interleaved codeword by interleaving the LDPC codeword on a bit group basis corresponding to the parallel factor of the LDPC codeword; and outputting the interleaved codeword to a modulator for 256-symbol mapping.

[0015] In accordance with still another aspect of the present invention, there is provided a BICM device, including an error-correction coder configured to output an LDPC codeword having a length of 16200 and a code rate of 2/15; a bit interleaver configured to interleave the LDPC codeword on a bit group basis corresponding to the parallel factor of the LDPC codeword and output the interleaved codeword; and a modulator configured to perform 256-symbol mapping on the interleaved codeword.

[0015a] According to an embodiment, there is provided a Bit-Interleaved Coded Modulation (BICM) reception device, comprising: a demodulator configured to perform demodulation corresponding to 256-symbol mapping; a bit deinterleaver configured to perform group-unit deinterleaving on interleaved values, the interleaved values generated after the demodulation; and a decoder configured to restore information bits by LDPC-decoding deinterleaved values generated based on the group-unit deinterleaving, the deinterleaved values corresponding to a LDPC codeword having a length of 16200 and a code rate of 2/15, the LDPC codeword encoded using a sequence, the sequence being equivalent to a parity check matrix (PCM), the sequence used for calculating parity bit addresses to perform accumulation for generating the LDPC codeword, wherein the sequence is represented by the following Sequence Table:

Sequence Table

1st row: 2889 3122 3208 4324 5968 7241 13215

2nd row: 281 923 1077 5252 6099 10309 11114

84125788

3rd row: 727 2413 2676 6151 6796 8945 12528

4th row: 2252 2322 3093 3329 8443 12170 13748

5th row: 575 2489 2944 6577 8772 11253 11657

6th row: 310 1461 2482 4643 4780 6936 11970

7th row: 8691 9746 10794 13582

8th row: 3717 6535 12470 12752

9th row: 6011 6547 7020 11746

10th row: 5309 6481 10244 13824

11st row: 5327 8773 8824 13343

12nd row: 3506 3575 9915 13609

13rd row: 3393 7089 11048 12816

14th row: 3651 4902 6118 12048

15th row: 4210 10132 13375 13377,

wherein the group-unit deinterleaving is performed on a group basis, the size of the group corresponding to a parallel factor of the LDPC codeword, wherein the group-unit deinterleaving corresponds to a reverse process of interleaving performed by using permutation order, and the permutation order corresponds to an interleaving sequence represented by the following interleaving sequence

= {31 3 38 9 34 6 4 18 15 1 21 19 42 20 12 13 30 26 14 2 10 35 28 44 23 11 22 16 29 40 27 37 25 41 5 43 39 36 7 24 32 17 33 8 0}.

[0015b] According to another embodiment, there is provided a broadcast signal reception method, comprising: performing demodulation corresponding to 256-symbol mapping;

performing group-unit deinterleaving on interleaved values, the interleaved values generated after the demodulation; and restoring information bits by LDPC-decoding deinterleaved values generated based on the group-unit deinterleaving, the deinterleaved values corresponding to a LDPC codeword having a length of 16200 and a code rate of 2/15, the LDPC codeword encoded using a sequence, the sequence being equivalent to a parity check matrix (PCM), the sequence used for calculating parity bit addresses to perform accumulation for generating the LDPC codeword, wherein the sequence is represented by the following Sequence Table:

Sequence Table

1st row: 2889 3122 3208 4324 5968 7241 13215

2nd row: 281 923 1077 5252 6099 10309 11114

3rd row: 727 2413 2676 6151 6796 8945 12528

4th row: 2252 2322 3093 3329 8443 12170 13748

5th row: 575 2489 2944 6577 8772 11253 11657

6th row: 310 1461 2482 4643 4780 6936 11970

7th row: 8691 9746 10794 13582

8th row: 3717 6535 12470 12752

9th row: 6011 6547 7020 11746

10th row: 5309 6481 10244 13824

11st row: 5327 8773 8824 13343

12nd row: 3506 3575 9915 13609

13rd row: 3393 7089 11048 12816

14th row: 3651 4902 6118 12048

15th row: 4210 10132 13375 13377,

wherein the group-unit deinterleaving is performed on a group basis, the size of the group corresponding to a parallel factor of the LDPC codeword, wherein the group-unit deinterleaving corresponds to a reverse process of interleaving performed by using permutation order, and the permutation order corresponds to an interleaving sequence represented by the following interleaving sequence

= {31 3 38 9 34 6 4 18 15 1 21 19 42 20 12 13 30 26 14 2 10 35 28 44 23 11 22 16 29 40 27 37 25 41 5 43 39 36 7 24 32 17 33 8 0}.

BRIEF DESCRIPTION OF THE DRAWINGS

[0016] The above and other objects, features and advantages of the present invention will be more clearly understood from the following detailed description taken in conjunction with the accompanying drawings, in which:

[0017] FIG. 1 is a block diagram illustrating a broadcast signal transmission and reception system according to an embodiment of the present invention;

[0018] FIG. 2 is an operation flowchart illustrating a broadcast signal transmission and reception method according to an embodiment of the present invention;

[0019] FIG. 3 is a diagram illustrating the structure of a parity check matrix (PCM) corresponding to an LDPC code according to an embodiment of the present invention;

[0020] FIG. 4 is a diagram illustrating the bit groups of an LDPC codeword having a length of 64800;

[0021] FIG. 5 is a diagram illustrating the bit groups of an LDPC codeword having a length of 16200;

[0022] FIG. 6 is a diagram illustrating interleaving that is performed on a bit group basis in accordance with an interleaving sequence;

[0023] FIG. 7 is a block diagram illustrating a bit interleaver according to an embodiment of the present invention; and

[0024] FIG. 8 is an operation flowchart illustrating a bit interleaving method according to an embodiment of the present invention.

DETAILED DESCRIPTION

[0025] Embodiments of the present invention will be described in detail below with reference to the accompanying drawings. Repeated descriptions and descriptions of well-known functions and configurations that have been deemed to make the gist of the present invention unnecessarily obscure will be omitted below. The embodiments of the present invention are intended to fully describe the present invention to persons having ordinary knowledge in the art to which the present invention pertains. Accordingly, the shapes, sizes, etc. of components in the drawings may be exaggerated to make the description obvious.

[0026] Embodiments of the present invention will be described in detail below with reference to the accompanying drawings.

[0027] FIG. 1 is a block diagram illustrating a broadcast signal transmission and reception system according to an embodiment of the present invention.

[0028] Referring to FIG. 1, it can be seen that a BICM device 10 and a BICM reception device 30 communicate with each other over a wireless channel 20.

[0029] The BICM device 10 generates an n-bit codeword by encoding k information bits 11 using an error-correction coder 13. In this case, the error-correction coder 13 may be an LDPC coder or a Turbo coder.

[0030] The codeword is interleaved by a bit interleaver 14, and thus the interleaved codeword is generated.

[0031] In this case, the interleaving may be performed on a bit group basis (by a unit of a bit group). In this case, the error-correction coder 13 may be an LDPC coder having a length of 16200 and a code rate of 2/15. A codeword having a length of 16200 may be divided into a total of 45 bit groups. Each of the bit groups may include 360 bits, i.e., the parallel factor of an LDPC codeword.

[0032] In this case, the interleaving may be performed on a bit group basis (by a unit of a bit group) in accordance with an interleaving sequence, which will be described later.

[0033] In this case, the bit interleaver 14 prevents the performance of error correction code from being degraded by effectively distributing burst errors occurring in a channel.

In this case, the bit interleaver 14 may be separately designed in accordance with the length and code rate of the error correction code and the modulation order.

[0034] The interleaved codeword is modulated by a modulator 15, and is then transmitted via an antenna 17.

[0035] In this case, the modulator 15 may be based on a concept including symbol mapper (symbol mapping device). In this case, the modulator 15 may be a symbol mapping device performing 256-symbol mapping which maps codes onto 256 constellations (symbols).

[0036] In this case, the modulator 15 may be a uniform modulator, such as a quadrature amplitude modulation (QAM) modulator, or a non-uniform modulator.

[0037] The modulator 15 may be a symbol mapping device performing NUC (Non-Uniform Constellation) symbol mapping which uses 256 constellations (symbols).

[0038] The signal transmitted via the wireless channel 20 is received via the antenna 31 of the BICM reception device 30, and, in the BICM reception device 30, is subjected to a process reverse to the process in the BICM device 10. That is, the received data is demodulated by a demodulator 33, is deinterleaved by a bit deinterleaver 34, and is then decoded by an error correction decoder 35, thereby finally restoring the information bits.

[0039] It will be apparent to those skilled in the art that the above-described transmission and reception processes have been described within a minimum range required for a description of the features of the present invention and various processes required for data transmission may be added.

[0040] FIG. 2 is an operation flowchart illustrating a broadcast signal transmission and reception method according to an embodiment of the present invention.

[0041] Referring to FIG. 2, in the broadcast signal transmission and reception method according to this embodiment of the present invention, input bits (information bits) are subjected to error-correction coding at step S210.

[0042] That is, at step S210, an n-bit codeword is generated by encoding k information bits using the error-correction coder.

[0043] In this case, step S210 may be performed as in an LDPC encoding method, which will be described later.

[0044] Furthermore, in the broadcast signal transmission and reception method, an interleaved codeword is generated by interleaving the n-bit codeword on a bit group basis at step S220.

[0045] In this case, the n-bit codeword may be an LDPC codeword having a length of 16200 and a code rate of 2/15. The codeword having a length of 16200 may be divided into a total of 45 bit groups. Each of the bit groups may include 360 bits corresponding to the parallel factors of an LDPC codeword.

[0046] In this case, the interleaving may be performed on a bit group basis (by a unit of a bit group) in accordance with an interleaving sequence, which will be described later.

[0047] Furthermore, in the broadcast signal transmission and reception method, the encoded data is modulated at step S230.

[0048] That is, at step S230, the interleaved codeword is modulated using the modulator.

[0049] In this case, the modulator may be based on a concept including symbol mapper (symbol mapping device). In this case, the modulator may be a symbol mapping device performing 256-symbol mapping which maps codes onto 256 constellations (symbols).

[0050] In this case, the modulator may be a uniform modulator, such as a QAM modulator, or a non-uniform modulator.

[0051] The modulator may be a symbol mapping device performing NUC (Non-Uniform Constellation) symbol mapping which uses 256 constellations (symbols).

[0052] Furthermore, in the broadcast signal transmission and reception method, the modulated data is transmitted at step S240.

[0053] That is, at step S240, the modulated codeword is transmitted over the wireless channel via the antenna.

[0054] Furthermore, in the broadcast signal transmission and reception method, the received data is demodulated at step S250.

[0055] That is, at step S250, the signal transmitted over the wireless channel is received via the antenna of the receiver, and the received data is demodulated using the demodulator.

[0056] Furthermore, in the broadcast signal transmission and reception method, the demodulated data is deinterleaved at step S260. In this case, the deinterleaving of step S260 may be reverse to the operation of step S220.

[0057] Furthermore, in the broadcast signal transmission and reception method, the deinterleaved codeword is subjected to error correction decoding at step S270.

[0058] That is, at step S270, the information bits are finally restored by performing error correction decoding using the error correction decoder of the receiver.

[0059] In this case, step S270 corresponds to a process reverse to that of an LDPC encoding method, which will be described later.

[0060] An LDPC code is known as a code very close to the Shannon limit for an additive white Gaussian noise (AWGN) channel, and has the advantages of asymptotically excellent performance and parallelizable decoding compared to a turbo code.

[0061] Generally, an LDPC code is defined by a low-density parity check matrix (PCM) that is randomly generated. However, a randomly generated LDPC code requires a large amount of memory to store a PCM, and requires a lot of time to access memory. In order to overcome these problems, a quasi-cyclic LDPC (QC-LDPC) code has been proposed. A QC-LDPC code that is composed of a zero matrix or a circulant permutation matrix (CPM) is defined by a PCM that is expressed by the following Equation 1:

$$H = \begin{bmatrix} J^{a_{11}} & J^{a_{12}} & \dots & J^{a_{1m}} \\ J^{a_{21}} & J^{a_{22}} & \dots & J^{a_{2n}} \\ \vdots & \vdots & \ddots & \vdots \\ J^{a_{m1}} & J^{a_{m2}} & \dots & J^{a_{mn}} \end{bmatrix}, \text{ for } a_{ij} \in \{0, 1, \dots, L-1, \infty\} \quad (1)$$

[0062] In this equation, J is a CPM having a size of $L \times L$, and is given as the following Equation 2. In the following description, L may be 360.

$$J_{L \times L} = \begin{bmatrix} 0 & 1 & 0 & \dots & 0 \\ 0 & 0 & 1 & \dots & 0 \\ \vdots & \vdots & \vdots & \ddots & \vdots \\ 0 & 0 & 0 & \dots & 1 \\ 1 & 0 & 0 & \dots & 0 \end{bmatrix} \quad (2)$$

[0063] Furthermore, J^i is obtained by shifting an $L \times L$ identity matrix $I (J^0)$ to the right i ($0 \leq i < L$) times, and J^∞ is an $L \times L$ zero matrix. Accordingly, in the case of a QC-LDPC code, it is sufficient if only index exponent i is stored in order to store J^i , and thus the amount of memory required to store a PCM is considerably reduced.

[0064] FIG. 3 is a diagram illustrating the structure of a PCM corresponding to an LDPC code to according to an embodiment of the present invention.

[0065] Referring to FIG. 3, the sizes of matrices A and C are $g \times K$ and $(N - K - g) \times (K + g)$, respectively, and are composed of an $L \times L$ zero matrix and a CPM, respectively. Furthermore, matrix Z is a zero matrix having a size of $g \times (N - K - g)$, matrix D is an identity matrix having a size of

$(N-K-g) \times (N-K-g)$, and matrix B is a dual diagonal matrix having a size of $g \times g$. In this case, the matrix B may be a matrix in which all elements except elements along a diagonal line and neighboring elements below the diagonal line are 0, and may be defined as the following Equation 3:

$$B_{g \times g} = \begin{bmatrix} I_{L \times L} & 0 & 0 & \dots & 0 & 0 & 0 \\ I_{L \times L} & I_{L \times L} & 0 & \dots & 0 & 0 & 0 \\ 0 & I_{L \times L} & I_{L \times L} & \vdots & 0 & 0 & 0 \\ \vdots & \vdots & \vdots & \ddots & \vdots & \vdots & \vdots \\ 0 & 0 & 0 & \dots & I_{L \times L} & I_{L \times L} & 0 \\ 0 & 0 & 0 & \dots & 0 & I_{L \times L} & I_{L \times L} \end{bmatrix} \quad (3)$$

where $I_{L \times L}$ is an identity matrix having a size of $L \times L$.

[0066] That is, the matrix B may be a bit-wise dual diagonal matrix, or may be a block-wise dual diagonal matrix having identity matrices as its blocks, as indicated by Equation 3. The bit-wise dual diagonal matrix is disclosed in detail in Korean Patent Application Publication No. 2007-0058438, etc.

[0067] In particular, it will be apparent to those skilled in the art that when the matrix B is a bit-wise dual diagonal matrix, it is possible to perform conversion into a Quasi-cyclic form by applying row or column permutation to a PCM including the matrix B and having a structure illustrated in FIG. 3.

[0068] In this case, N is the length of a codeword, and K is the length of information.

[0069] The present invention proposes a newly designed QC-LDPC code in which the code rate thereof is 2/15 and the length of a codeword is 16200, as illustrated in the following Table 1. That is, the present invention proposes an LDPC code that is designed to receive information having a length of 2160 and generate an LDPC codeword having a length of 16200.

[0070] Table 1 illustrates the sizes of the matrices A, B, C, D and Z of the QC-LDPC code according to the present invention:

Table 1

Code rate	Length	Sizes				
		A	B	C	D	Z
2/15	16200	3240 × 2160	3240 × 3240	10800 × 5400	10800 × 10800	3240 × 10800

[0071] The newly designed LDPC code may be represented in the form of a sequence (progression), an equivalent relationship is established between the sequence and matrix (parity bit check matrix), and the sequence may be represented, as follows:

Sequence Table

1st row: 2889 3122 3208 4324 5968 7241 13215
 2nd row: 281 923 1077 5252 6099 10309 11114
 3rd row: 727 2413 2676 6151 6796 8945 12528
 4th row: 2252 2322 3093 3329 8443 12170 13748
 5th row: 575 2489 2944 6577 8772 11253 11657
 6th row: 310 1461 2482 4643 4780 6936 11970
 7th row: 8691 9746 10794 13582
 8th row: 3717 6535 12470 12752
 9th row: 6011 6547 7020 11746
 10th row: 5309 6481 10244 13824
 11st row: 5327 8773 8824 13343
 12nd row: 3506 3575 9915 13609
 13rd row: 3393 7089 11048 12816
 14th row: 3651 4902 6118 12048
 15th row: 4210 10132 13375 13377

[0072] An LDPC code that is represented in the form of a sequence is being widely used in the DVB standard.

[0073] According to an embodiment of the present invention, an LDPC code presented in the form of a sequence is encoded, as follows. It is assumed that there is an information block $S = (s_0, s_1, \dots, s_{K-1})$ having an information size K . The LDPC encoder generates a codeword $\Lambda = (\lambda_0, \lambda_1, \lambda_2, \dots, \lambda_{N-1})$ having a size of $N = K + M_1 + M_2$ using the information block S having a size K . In this case, $M_1 = g$, and $M_2 = N - K - g$. Furthermore, M_1 is the size of parity bits corresponding to the dual diagonal matrix B, and M_2 is the size of parity bits corresponding to the identity matrix D. The encoding process is performed, as follows:

[0074] Initialization:

$$\begin{aligned} \lambda_i &= s_i \text{ for } i = 0, 1, \dots, K-1 \\ p_j &= 0 \text{ for } j = 0, 1, \dots, M_1 + M_2 - 1 \end{aligned} \tag{4}$$

[0075] First information bit λ_0 is accumulated at parity bit addresses specified in the 1st row of the sequence of the Sequence Table. For example, in an LDPC code having a length of 16200 and a code rate of 2/15, an accumulation process is as follows:

$$\begin{aligned} P_{2889} &= P_{2889} \oplus \lambda_0 & P_{3122} &= P_{3122} \oplus \lambda_0 & P_{3208} &= P_{3208} \oplus \lambda_0 & P_{4324} &= P_{4324} \oplus \lambda_0 & P_{5968} &= P_{5968} \oplus \lambda_0 \\ P_{7241} &= P_{7241} \oplus \lambda_0 & P_{13215} &= P_{13215} \oplus \lambda_0 \end{aligned}$$

where the addition \oplus occurs in GF(2).

[0076] The subsequent $L-1$ information bits, that is, $\lambda_m, m=1,2,\dots,L-1$, are accumulated at parity bit addresses that are calculated by the following Equation 5:

$$\begin{aligned} (x + m \times Q_1) \bmod M_1 & \text{ if } x < M_1 \\ M_1 + \{(x - M_1 + m \times Q_2) \bmod M_2\} & \text{ if } x \geq M_1 \end{aligned} \quad (5)$$

where x denotes the addresses of parity bits corresponding to the first information bit λ_0 , that is, the addresses of the parity bits specified in the first row of the sequence of the Sequence Table, $Q_1 = M_1/L$, $Q_2 = M_2/L$, and $L = 360$. Furthermore, Q_1 and Q_2 are defined in the following Table 2. For example, for an LDPC code having a length of 16200 and a code rate of 2/15, $M_1 = 3240$, $Q_1 = 9$, $M_2 = 10800$, $Q_2 = 30$ and $L = 360$, and the following operations are performed on the second bit λ_1 using Equation 5:

$$\begin{aligned} P_{2898} &= P_{2898} \oplus \lambda_1 & P_{3131} &= P_{3131} \oplus \lambda_1 & P_{3217} &= P_{3217} \oplus \lambda_1 & P_{4334} &= P_{4334} \oplus \lambda_1 & P_{5998} &= P_{5998} \oplus \lambda_1 \\ P_{7271} &= P_{7271} \oplus \lambda_1 & P_{13245} &= P_{13245} \oplus \lambda_1 \end{aligned}$$

[0077] Table 2 illustrates the sizes of M_1 , Q_1 , M_2 and Q_2 of the designed QC-LDPC code:

Table 2

Code rate	Length	Sizes			
		M_1	M_2	Q_1	Q_2
2/15	16200	3240	10800	9	30

[0078] The addresses of parity bit accumulators for new 360 information bits from λ_L to λ_{2L-1} are calculated and accumulated from Equation 5 using the second row of the sequence.

[0079] In a similar manner, for all groups composed of new L information bits, the addresses of parity bit accumulators are calculated and accumulated from Equation 5 using new rows of the sequence.

[0080] After all the information bits from λ_0 to λ_{K-1} have been exhausted, the operations of the following Equation 6 are sequentially performed from $i = 1$:

$$p_i = p_i \oplus p_{i-1} \text{ for } i = 0, 1, \dots, M_1 - 1 \quad (6)$$

[0081] Thereafter, when a parity interleaving operation, such as that of the following Equation 7, is performed, parity bits corresponding to the dual diagonal matrix B are generated:

$$\lambda_{K+L+i} = p_{Q_1+s+i} \text{ for } 0 \leq s < L, \quad 0 \leq t < Q_1 \quad (7)$$

[0082] When the parity bits corresponding to the dual diagonal matrix B have been generated using K information bits $\lambda_0, \lambda_1, \dots, \lambda_{K-1}$, parity bits corresponding to the identity matrix D are generated using the M_1 generated parity bits $\lambda_K, \lambda_{K+1}, \dots, \lambda_{K+M_1-1}$.

[0083] For all groups composed of L information bits from λ_K to λ_{K+M_1-1} , the addresses of parity bit accumulators are calculated using the new rows (starting with a row immediately subsequent to the last row used when the parity bits corresponding to the dual diagonal matrix B have been generated) of the sequence and Equation 5, and related operations are performed.

[0084] When a parity interleaving operation, such as that of the following Equation 8, is performed after all the information bits from λ_K to λ_{K+M_1-1} have been exhausted, parity bits corresponding to the identity matrix D are generated:

$$\lambda_{K+M_1+L+i} = p_{M_1+Q_2+s+i} \text{ for } 0 \leq s < L, \quad 0 \leq t < Q_2 \quad (8)$$

[0086] FIG. 4 is a diagram illustrating the bit groups of an LDPC codeword having a length of 64800.

[0087] Referring to FIG. 4, it can be seen that an LDPC codeword having a length of 64800 is divided into 180 bit groups (a 0th group to a 179th group).

[0088] In this case, 360 may be the parallel factor (PF) of the LDPC codeword. That is, since the PF is 360, the LDPC codeword having a length of 64800 is divided into 180 bit groups, as illustrated in FIG. 4, and each of the bit groups includes 360 bits.

[0089] FIG. 5 is a diagram illustrating the bit groups of an LDPC codeword having a length of 16200.

[0090] Referring to FIG. 5, it can be seen that an LDPC codeword having a length of 16200 is divided into 45 bit groups (a 0th group to a 44th group).

[0091] In this case, 360 may be the parallel factor (PF) of the LDPC codeword. That is, since the PF is 360, the LDPC codeword having a length of 16200 is divided into 45 bit groups, as illustrated in FIG. 5, and each of the bit groups includes 360 bits.

[0092] FIG. 6 is a diagram illustrating interleaving that is performed on a bit group basis in accordance with an interleaving sequence.

[0093] Referring to FIG. 6, it can be seen that interleaving is performed by changing the order of bit groups by a designed interleaving sequence.

[0094] For example, it is assumed that an interleaving sequence for an LDPC codeword having a length of 16200 is as follows:

interleaving sequence = {24 34 15 11 2 28 17 25 5 38 19 13 6 39 1 14 33 37 29
12 42 31 30 32 36 40 26 35 44 4 16 8 20 43 21 7 0 18 23 3 10 41 9 27 22}

[0095] Then, the order of the bit groups of the LDPC codeword illustrated in FIG. 4 is changed into that illustrated in FIG. 6 by the interleaving sequence.

[0096] That is, it can be seen that each of the LDPC codeword 610 and the interleaved codeword 620 includes 45 bit groups, and it can be also seen that, by the interleaving sequence, the 24th bit group of the LDPC codeword 610 is changed into the 0th bit group of the interleaved LDPC codeword 620, the 34th bit group of the LDPC codeword 610 is changed into the 1st bit group of the interleaved LDPC codeword 620, the 15th bit group of the LDPC codeword 610 is changed into the 2nd bit group of the interleaved LDPC codeword 620, and the 11st bit group of the LDPC codeword 610 is changed into the 3rd bit group of the interleaved LDPC codeword 620, and the 2nd bit group of the LDPC codeword 610 is changed into the 4th bit group of the interleaved LDPC codeword 620.

[0097] An LDPC codeword $(u_0, u_1, \dots, u_{N_{ldpc}-1})$ having a length of N_{ldpc} ($N_{ldpc} = 16200$) is divided into $N_{group} = N_{ldpc} / 360$ bit groups, as in Equation 9 below:

$$X_j = \{u_k \mid 360 \times j \leq k < 360 \times (j+1), \quad 0 \leq k < N_{ldpc}\} \text{ for } 0 \leq j < N_{group} \quad (9)$$

where X_j is an j -th bit group, and each X_j is composed of 360 bits.

[0098] The LDPC codeword divided into the bit groups is interleaved, as in Equation 10 below:

$$Y_j = X_{\pi(j)} \quad 0 \leq j \leq N_{group} \quad (10)$$

where Y_j is an interleaved j -th bit group, and $\pi(j)$ is a permutation order for bit group-based interleaving (bit group-unit interleaving). The permutation order corresponds to the interleaving sequence of Equation 11 below:

$$\begin{aligned} &\text{interleaving sequence} \\ &= \{31 \ 3 \ 38 \ 9 \ 34 \ 6 \ 4 \ 18 \ 15 \ 1 \ 21 \ 19 \ 42 \ 20 \ 12 \ 13 \ 30 \ 26 \ 14 \ 2 \ 10 \ 35 \ 28 \ 44 \ 23 \ 11 \ 22 \\ &16 \ 29 \ 40 \ 27 \ 37 \ 25 \ 41 \ 5 \ 43 \ 39 \ 36 \ 7 \ 24 \ 32 \ 17 \ 33 \ 8 \ 0\} \end{aligned} \quad (11)$$

[0099] That is, when each of the codeword and the interleaved codeword includes 45 bit groups ranging from a 0th bit group to a 44th bit group, the interleaving sequence of Equation 11 means that the 31th bit group of the codeword becomes the 0th bit group of the interleaved codeword, the 3th bit group of the codeword becomes the 1st bit group of the interleaved codeword, the 38th bit group of the codeword becomes the 2nd bit group of the interleaved codeword, the 9th bit group of the codeword becomes the 3rd bit group of the interleaved codeword, ..., the 8th bit group of the codeword becomes the 43th bit group of the interleaved codeword, and the 0th bit group of the codeword becomes the 44th bit group of the interleaved codeword.

[00100] In particular, the interleaving sequence of Equation 11 has been optimized for a case where 256-symbol mapping (NUC symbol mapping) is employed and an LDPC coder having a length of 16200 and a code rate of 2/15 is used.

[00101] FIG. 7 is a block diagram illustrating a bit interleaver according to an embodiment of the present invention.

[00102] Referring to FIG. 7, the bit interleaver according to the present embodiment includes memories 710 and 730 and a processor 720.

[00103] The memory 710 stores an LDPC codeword having a length of 16200 and a code rate of 2/15.

[00104] The processor 720 generates an interleaved codeword by interleaving the LDPC codeword on a bit group basis corresponding to the parallel factor of the LDPC codeword.

[00105] In this case, the parallel factor may be 360. In this case, each of the bit groups may include 360 bits.

[00106] In this case, the LDPC codeword may be divided into 45 bit groups, as in Equation 9.

[00107] In this case, the interleaving may be performed using Equation 10 using permutation order.

[00108] In this case, the permutation order may correspond to the interleaving sequence represented by Equation 11.

[00109] The memory 730 provides the interleaved codeword to a modulator for 256-symbol mapping.

[00110] In this case, the modulator may be a symbol mapping device performing NUC (Non-Uniform Constellation) symbol mapping.

[00111] The memories 710 and 730 may correspond to various types of hardware for storing a set of bits, and may correspond to a data structure, such as an array, a list, a stack, a queue or the like.

[00112] In this case, the memories 710 and 730 may not be physically separate devices, but may correspond to different addresses of a physically single device. That is, the memories 710 and 730 are not physically distinguished from each other, but are merely logically distinguished from each other.

[00113] The error-correction coder 13 illustrated in FIG. 1 may be implemented in the same structure as in FIG. 7.

[00114] That is, the error-correction coder may include memories and a processor. In this case, the first memory is a memory that stores an LDPC codeword having a length of 16200 and a code rate of 2/15, and a second memory is a memory that is initialized to 0.

[00115] The memories may correspond to $\lambda_i (i = 0, 1, \dots, N-1)$ and $P_j (j = 0, 1, \dots, M_1 + M_2 - 1)$, respectively.

[00116] The processor may generate an LDPC codeword corresponding to information bits by performing accumulation with respect to the memory using a sequence corresponding to a parity check matrix (PCM).

[00117] In this case, the accumulation may be performed at parity bit addresses that are updated using the sequence of the above Sequence Table.

[00118] In this case, the LDPC codeword may include a systematic part $\lambda_0, \lambda_1, \dots, \lambda_{K-1}$ corresponding to the information bits and having a length of 2160 ($= K$), a first parity part $\lambda_K, \lambda_{K+1}, \dots, \lambda_{K+M_1-1}$ corresponding to a dual diagonal matrix included in the PCM and having a length of 3240 ($= M_1 = g$), and a second parity part $\lambda_{K+M_1}, \lambda_{K+M_1+1}, \dots, \lambda_{K+M_1+M_2-1}$ corresponding to an identity matrix included in the PCM and having a length of 10800 ($= M_2$).

[00119] In this case, the sequence may have a number of rows equal to the sum $(2160/360+3240/360=15)$ of a value obtained by dividing the length of the systematic part, that is, 2160, by a CPM size L corresponding to the PCM, that is, 360, and a value obtained by dividing the length M_1 of the first parity part, that is, 3240, by 360.

[00120] As described above, the sequence may be represented by the above Sequence Table.

[00121] In this case, the second memory may have a size corresponding to the sum $M_1 + M_2$ of the length M_1 of the first parity part and the length M_2 of the second parity part.

[00122] In this case, the parity bit addresses may be updated based on the results of comparing each x of the previous parity bit addresses, specified in respective rows of the sequence, with the length M_1 of the first parity part.

[00123] That is, the parity bit addresses may be updated using Equation 5. In this case, x may be the previous parity bit addresses, m may be an information bit index that is an integer larger than 0 and smaller than L , L may be the CPM size of the PCM, Q_1 may be M_1/L , M_1 may be the size of the first parity part, Q_2 may be M_2/L , and M_2 may be the size of the second parity part.

[00124] In this case, it may be possible to perform the accumulation while repeatedly changing the rows of the sequence by the CPM size L (=360) of the PCM, as described above.

[00125] In this case, the first parity part $\lambda_K, \lambda_{K+1}, \dots, \lambda_{K+M_1-1}$ may be generated by performing parity interleaving using the first memory and the second memory, as described in conjunction with Equation 7.

[00126] In this case, the second parity part $\lambda_{K+M_1}, \lambda_{K+M_1+1}, \dots, \lambda_{K+M_1+M_2-1}$ may be generated by performing parity interleaving using the first memory and the second memory after generating the first parity part $\lambda_K, \lambda_{K+1}, \dots, \lambda_{K+M_1-1}$ and then performing the accumulation using the first parity part $\lambda_K, \lambda_{K+1}, \dots, \lambda_{K+M_1-1}$ and the sequence, as described in conjunction with Equation 8.

[00127] FIG. 8 is an operation flowchart illustrating a bit interleaving method according to an embodiment of the present invention.

[00128] Referring to FIG. 8, in the bit interleaving method according to the present embodiment, an LDPC codeword having a length of 16200 and a code rate of 2/15 is stored at step S810.

[00129] In this case, the LDPC codeword may be represented by $(u_0, u_1, \dots, u_{N_{ldpc}-1})$ (where N_{ldpc} is 16200), and may be divided into 45 bit groups each composed of 360 bits, as in Equation 9.

[00130] Furthermore, in the bit interleaving method according to the present embodiment, an interleaved codeword is generated by interleaving the LDPC codeword on a bit group basis at step S820.

[00131] In this case, the size of the bit group may correspond to the parallel factor of the LDPC codeword.

[00132] In this case, the interleaving may be performed using Equation 10 using permutation order.

[00133] In this case, the permutation order may correspond to the interleaving sequence represented by Equation 11.

[00134] In this case, the parallel factor may be 360, and each of the bit groups may include 360 bits.

[00135] In this case, the LDPC codeword may be divided into 45 bit groups, as in Equation 9.

[00136] Moreover, in the bit interleaving method according to the present embodiment, the interleaved codeword is output to a modulator for 256-symbol mapping at step 830.

[00137] In accordance with at least one embodiment of the present invention, there is provided an intra-BICM bit interleaver that can effectively distribute burst errors occurring in a broadcasting system channel.

[00138] In accordance with at least one embodiment of the present invention, there is provided a bit interleaver that is optimized for an LDPC coder having a length of 16200 and a code rate of 2/15 and a modulator performing 256-symbol mapping and, thus, can be applied to next-generation broadcasting systems, such as ATSC 3.0.

[00139] Although the specific embodiments of the present invention have been disclosed for illustrative purposes, those skilled in the art will appreciate that various modifications, additions and substitutions are possible without departing from the scope and spirit of the invention as disclosed in the accompanying claims.

CLAIMS:

1. A Bit-Interleaved Coded Modulation (BICM) reception device, comprising:

a demodulator configured to perform demodulation corresponding to 256-symbol mapping;

a bit deinterleaver configured to perform group-unit deinterleaving on interleaved values, the interleaved values generated after the demodulation; and

a decoder configured to restore information bits by LDPC-decoding deinterleaved values generated based on the group-unit deinterleaving, the deinterleaved values corresponding to a LDPC codeword having a length of 16200 and a code rate of 2/15, the LDPC codeword encoded using a sequence, the sequence being equivalent to a parity check matrix (PCM), the sequence used for calculating parity bit addresses to perform accumulation for generating the LDPC codeword,

wherein the sequence is represented by the following Sequence Table:

Sequence Table

1st row: 2889 3122 3208 4324 5968 7241 13215

2nd row: 281 923 1077 5252 6099 10309 11114

3rd row: 727 2413 2676 6151 6796 8945 12528

4th row: 2252 2322 3093 3329 8443 12170 13748

5th row: 575 2489 2944 6577 8772 11253 11657

6th row: 310 1461 2482 4643 4780 6936 11970

7th row: 8691 9746 10794 13582

8th row: 3717 6535 12470 12752

9th row: 6011 6547 7020 11746

10th row: 5309 6481 10244 13824

11st row: 5327 8773 8824 13343

12nd row: 3506 3575 9915 13609

13rd row: 3393 7089 11048 12816

14th row: 3651 4902 6118 12048

15th row: 4210 10132 13375 13377,

wherein the group-unit deinterleaving is performed on a group basis, the size of the group corresponding to a parallel factor of the LDPC codeword,

wherein the group-unit deinterleaving corresponds to a reverse process of interleaving performed by using permutation order, and

the permutation order corresponds to an interleaving sequence represented by the following

interleaving sequence

= {31 3 38 9 34 6 4 18 15 1 21 19 42 20 12 13 30 26 14 2 10 35 28 44 23 11 22 16 29 40 27 37 25 41 5 43 39 36 7 24 32 17 33 8 0}.

2. The BICM reception device of claim 1, wherein the 256-symbol mapping is a Non-Uniform Constellation (NUC) symbol mapping which corresponds to 256 constellations.
3. The BICM reception device of claim 1, wherein the parallel factor is 360, and the group includes 360 values.
4. The BICM reception device of claim 3, wherein the group corresponds to a bit group of the LDPC codeword in the following equation, the LDPC codeword is represented by

$(u_0, u_1, \dots, u_{N_{ldpc}-1})$ (where N_{ldpc} is 16200):

$$X_j = \{u_k \mid 360 \times j \leq k < 360 \times (j+1), \quad 0 \leq k < N_{ldpc}\} \text{ for } 0 \leq j < N_{group}$$

where X_j is an j -th bit group, N_{ldpc} is 16200, and N_{group} is 45.

5. A broadcast signal reception method, comprising:

performing demodulation corresponding to 256-symbol mapping;

performing group-unit deinterleaving on interleaved values, the interleaved values generated after the demodulation; and

restoring information bits by LDPC-decoding deinterleaved values generated based on the group-unit deinterleaving, the deinterleaved values corresponding to a LDPC codeword having a length of 16200 and a code rate of 2/15, the LDPC codeword encoded using a sequence, the sequence being equivalent to a parity check matrix (PCM), the sequence used for calculating parity bit addresses to perform accumulation for generating the LDPC codeword,

wherein the sequence is represented by the following Sequence Table:

Sequence Table

1st row: 2889 3122 3208 4324 5968 7241 13215

2nd row: 281 923 1077 5252 6099 10309 11114

3rd row: 727 2413 2676 6151 6796 8945 12528

4th row: 2252 2322 3093 3329 8443 12170 13748

5th row: 575 2489 2944 6577 8772 11253 11657

6th row: 310 1461 2482 4643 4780 6936 11970

7th row: 8691 9746 10794 13582

8th row: 3717 6535 12470 12752

9th row: 6011 6547 7020 11746

10th row: 5309 6481 10244 13824

11st row: 5327 8773 8824 13343

12nd row: 3506 3575 9915 13609

13rd row: 3393 7089 11048 12816

14th row: 3651 4902 6118 12048

15th row: 4210 10132 13375 13377,

wherein the group-unit deinterleaving is performed on a group basis, the size of the group corresponding to a parallel factor of the LDPC codeword,

wherein the group-unit deinterleaving corresponds to a reverse process of interleaving performed by using permutation order, and

the permutation order corresponds to an interleaving sequence represented by the following

interleaving sequence

= {31 3 38 9 34 6 4 18 15 1 21 19 42 20 12 13 30 26 14 2 10 35 28 44 23 11 22 16 29 40 27 37 25 41 5 43 39 36 7 24 32 17 33 8 0}.

6. The broadcast signal reception method of claim 5, wherein the 256-symbol mapping is a Non-Uniform Constellation (NUC) symbol mapping which corresponds to 256 constellations.

7. The broadcast signal reception method of claim 5, wherein the parallel factor is 360, and the group includes 360 values.

8. The broadcast signal reception method of claim 7, wherein the group corresponds to a bit group of the LDPC codeword in the following equation, the LDPC codeword is represented by $(u_0, u_1, \dots, u_{N_{ldpc}-1})$ (where N_{ldpc} is 16200):

$$X_j = \{u_k \mid 360 \times j \leq k < 360 \times (j+1), \quad 0 \leq k < N_{ldpc}\} \text{ for } 0 \leq j < N_{group}$$

where X_j is an j -th bit group, N_{ldpc} is 16200, and N_{group} is 45.

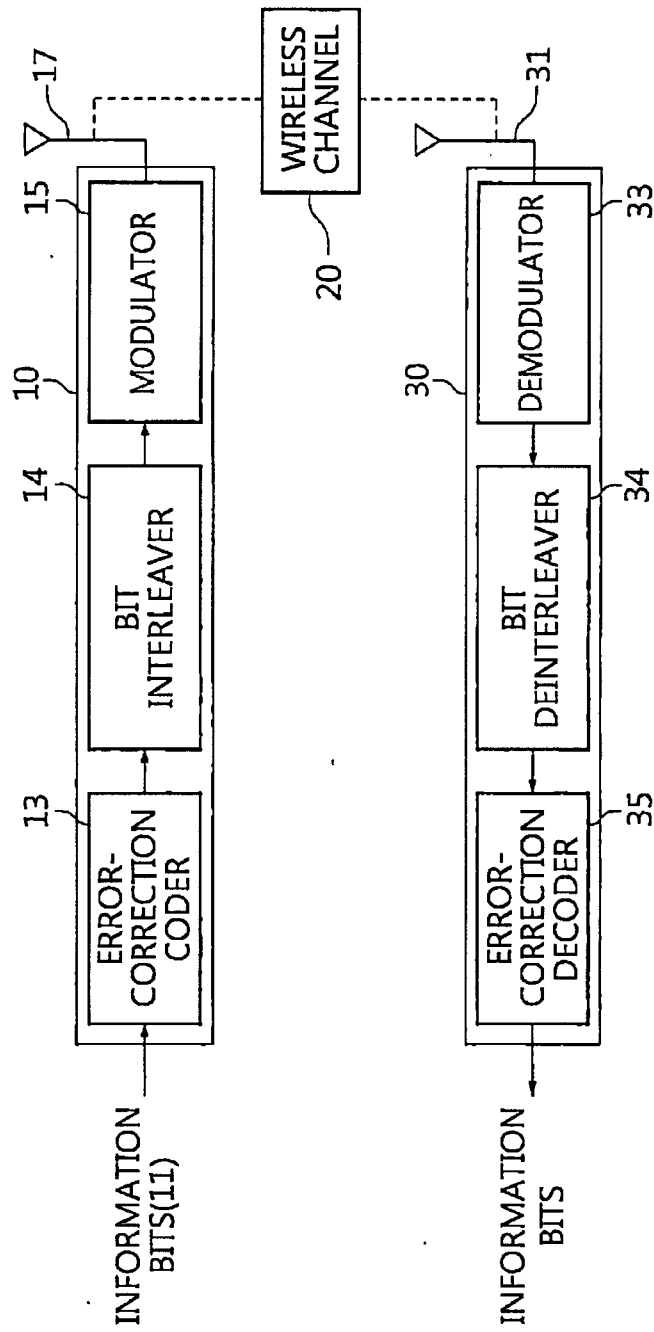

FIG. 1

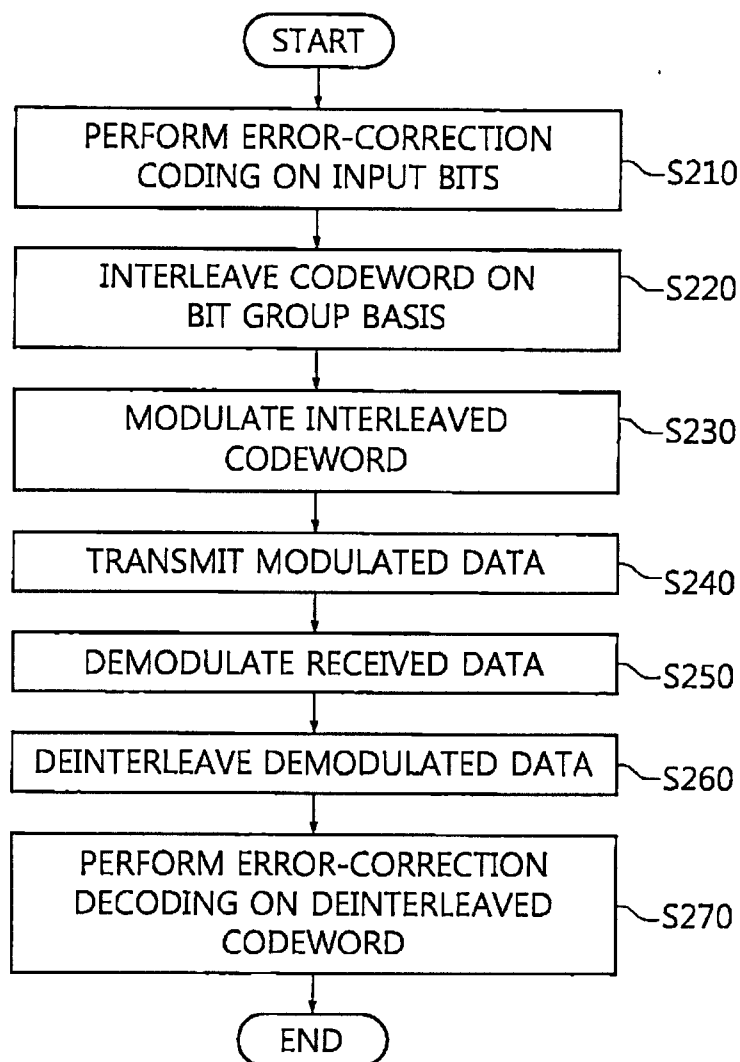

FIG. 2

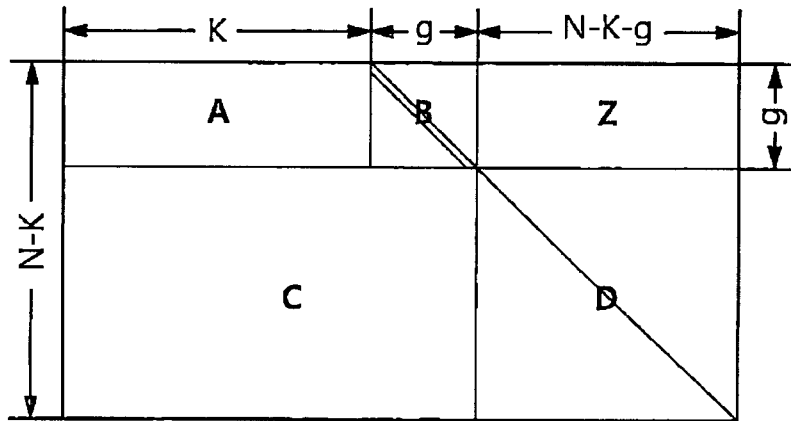

FIG. 3

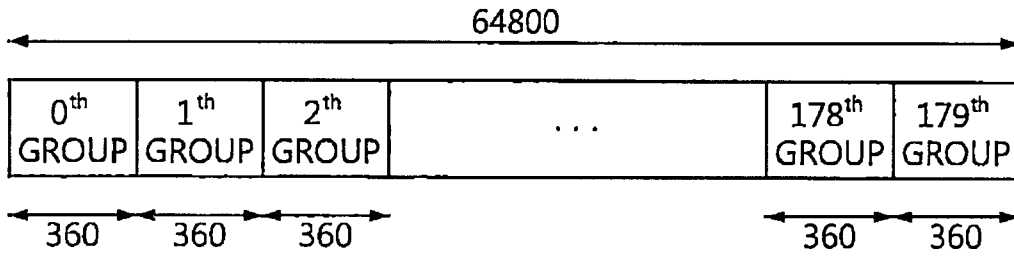

FIG. 4

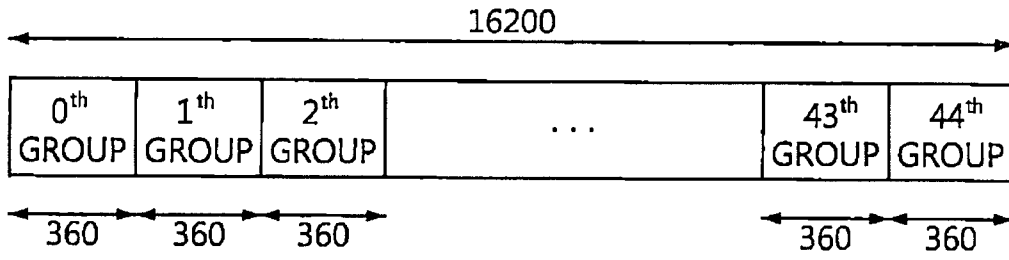

FIG. 5

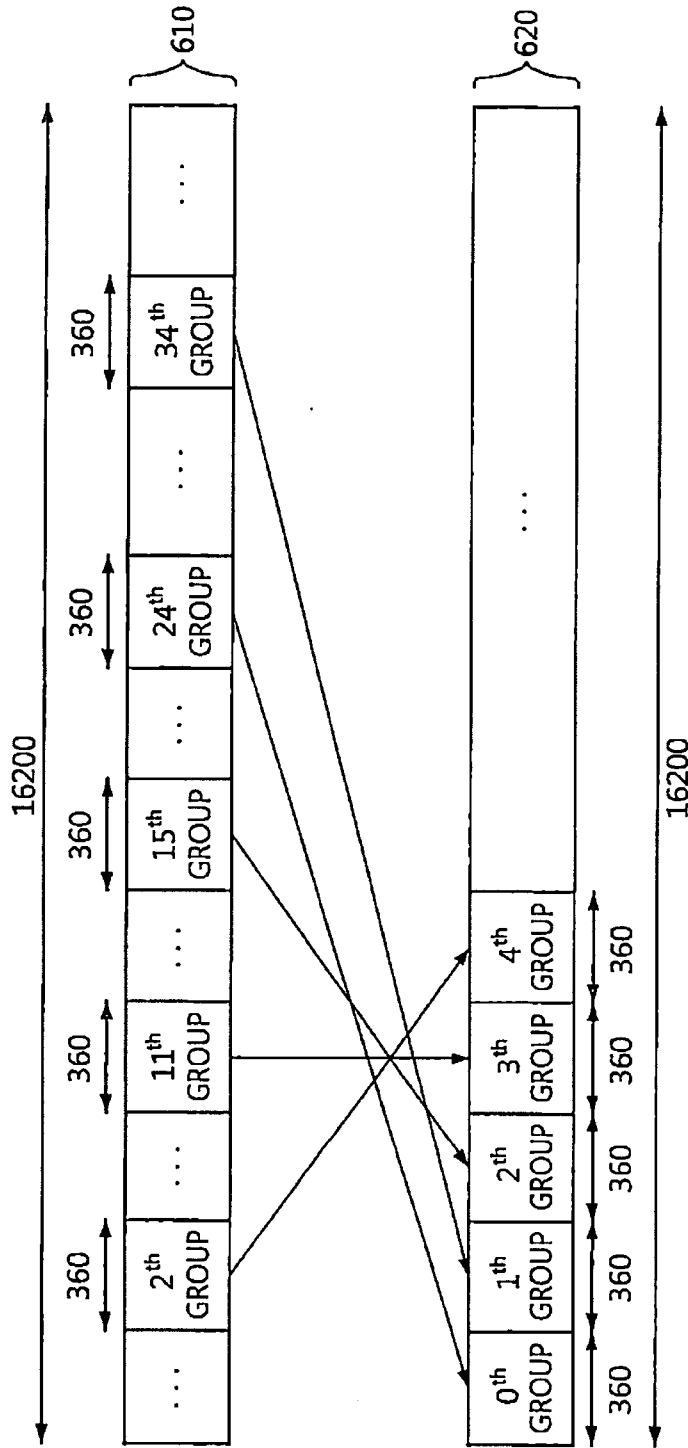

FIG. 6

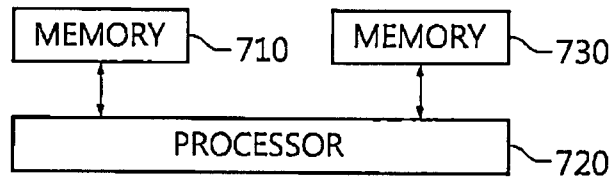

FIG. 7

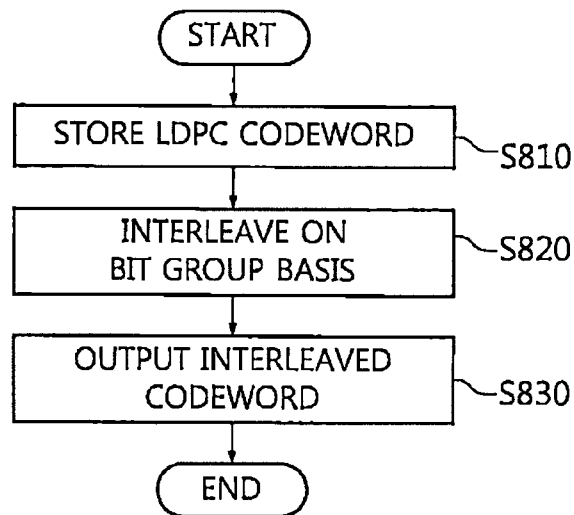

FIG. 8

