



US00D888473S

(12) **United States Design Patent**  
**Li**

(10) **Patent No.:** **US D888,473 S**

(45) **Date of Patent:** **\*\* Jun. 30, 2020**

(54) **JEWELRY ORGANIZER**

(71) Applicant: **SHENZHENSHI HONGYUE KEJI**  
**YOUXIANGONGSI, Shenzhen (CN)**

(72) Inventor: **Hongchao Li, Shenzhen (CN)**

(73) Assignee: **SHENZHENSHI HONGYUE KEJI**  
**YOUXIANGONGSI, Shenzhen (CN)**

(\*\*) Term: **15 Years**

(21) Appl. No.: **29/727,610**

(22) Filed: **Mar. 12, 2020**

(51) **LOC (12) Cl.** ..... **06-06**

(52) **U.S. Cl.**  
USPC ..... **D6/682.6**

(58) **Field of Classification Search**  
USPC ..... D6/672, 675, 675.1, 678, 678.1, 680.2,  
D6/681, 681.1, 682, 682.5, 682.6  
CPC .. A47F 5/04; A47F 5/0876; A47F 7/02; A47F  
5/10  
See application file for complete search history.

(56) **References Cited**

**U.S. PATENT DOCUMENTS**

3,424,313	A *	1/1969	Feibelman	.....	A47F 5/04
					211/85.2
D332,881	S *	2/1993	Blackburn	.....	D19/82
D333,559	S *	3/1993	Rowley	.....	D3/25
D336,574	S *	6/1993	Rhodes	.....	D6/681.3
5,568,872	A *	10/1996	Hinnant, Sr.	.....	A47F 7/021
					211/85.1
D396,363	S *	7/1998	Skrum	.....	D6/682.2
D458,770	S *	6/2002	Walter	.....	D6/681.1
D459,106	S *	6/2002	Walter	.....	D6/681.1
D467,094	S *	12/2002	Bodzioch	.....	D6/682
D474,352	S *	5/2003	Shepard	.....	
D496,191	S *	9/2004	Johnson	.....	D6/681.3

D563,694	S *	3/2008	Mitchell	.....	D6/682.6
D610,367	S *	2/2010	Mandel	.....	D19/77
D655,530	S *	3/2012	Denby	.....	D6/681.1
9,107,514	B1 *	8/2015	Morieras	.....	A47F 7/02
D761,601	S *	7/2016	Simmons	.....	D6/681
D762,403	S *	8/2016	Williams	.....	D6/681.1
D807,037	S *	1/2018	O'Malley	.....	
10,092,116	B1 *	10/2018	Johns	.....	A47F 7/022
D848,187	S *	5/2019	Lee	.....	D6/681.1

\* cited by examiner

*Primary Examiner* — Kelley A Donnelly

(57) **CLAIM**

The ornamental design for a jewelry organizer, as shown and described.

**DESCRIPTION**

FIG. 1 is a perspective view of a first embodiment of a jewelry organizer showing my new design;  
 FIG. 2 is another perspective view thereof;  
 FIG. 3 is a front elevational view thereof;  
 FIG. 4 is a rear elevational view thereof;  
 FIG. 5 is a left side elevational view thereof;  
 FIG. 6 is a right side elevational view thereof;  
 FIG. 7 is a top plan view thereof;  
 FIG. 8 is a bottom plan view thereof;  
 FIG. 9 is a perspective view of a second embodiment of the jewelry organizer showing my new design;  
 FIG. 10 is another perspective view thereof;  
 FIG. 11 is a front elevational view thereof;  
 FIG. 12 is a rear elevational view thereof;  
 FIG. 13 is a left side elevational view thereof;  
 FIG. 14 is a right side elevational view thereof;  
 FIG. 15 is a top plan view thereof; and,  
 FIG. 16 is a bottom plan view thereof.  
 The broken lines in the drawings depict boundaries of the jewelry organizer that form no part of the claimed design.

**1 Claim, 16 Drawing Sheets**

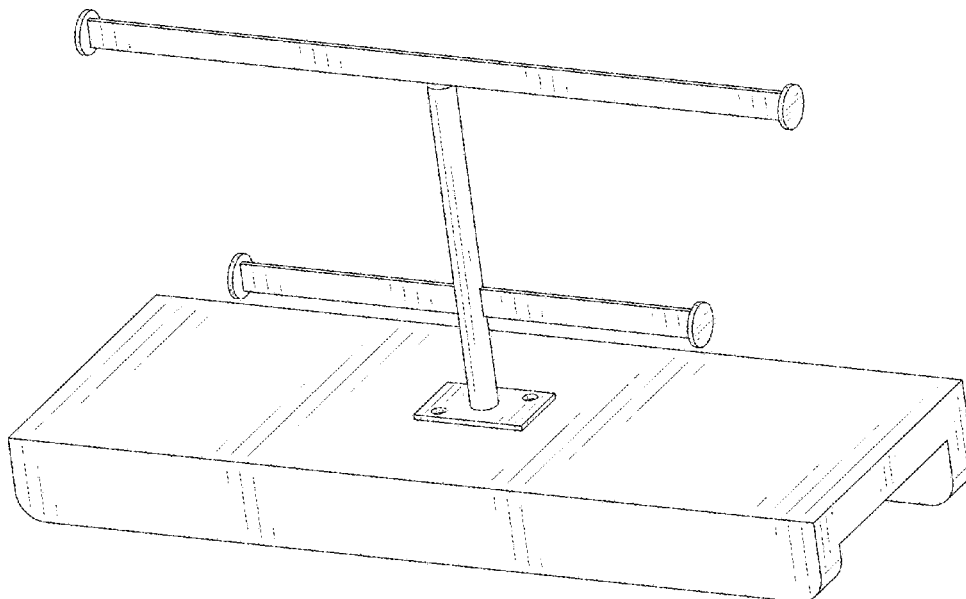

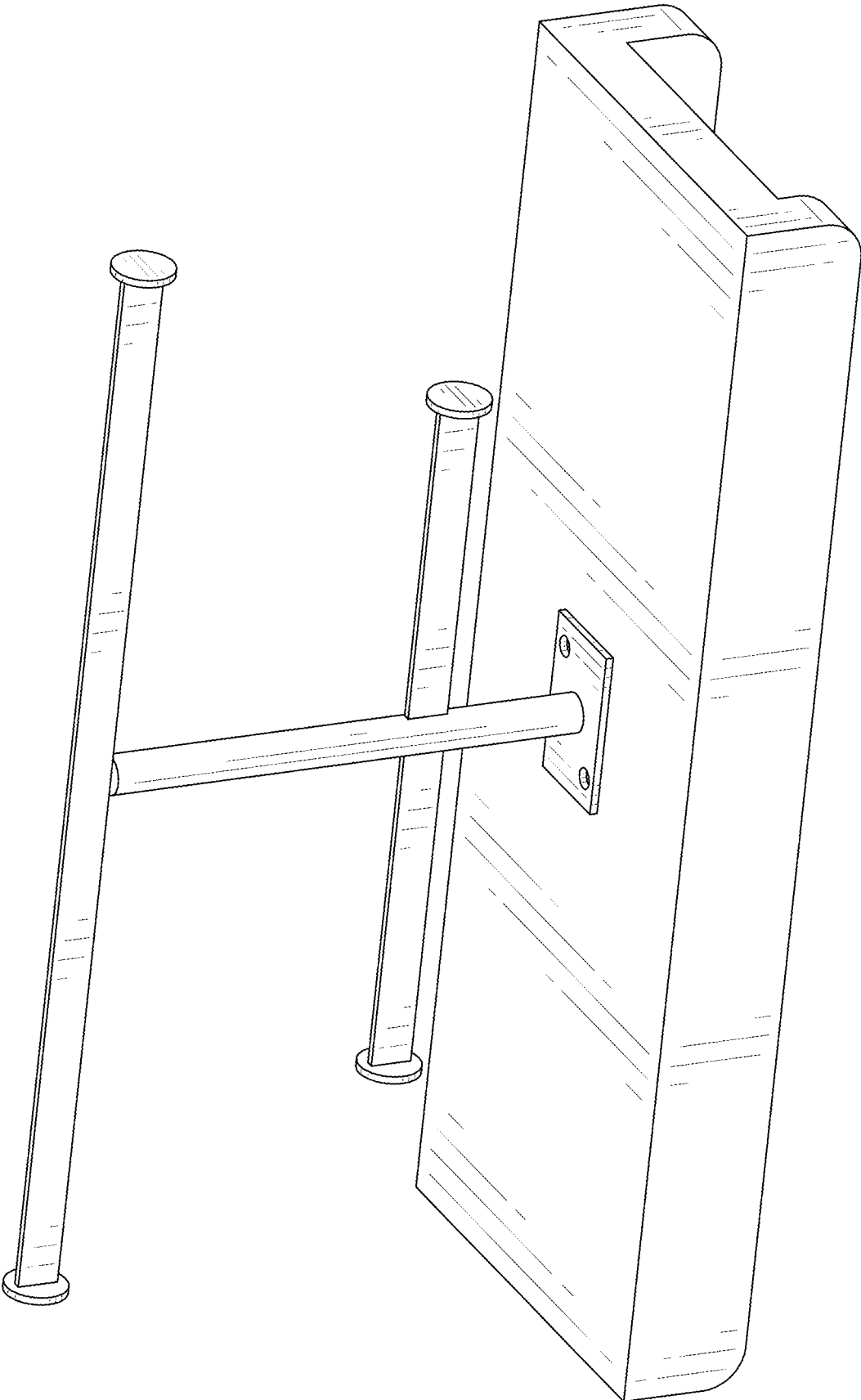

FIG. 1

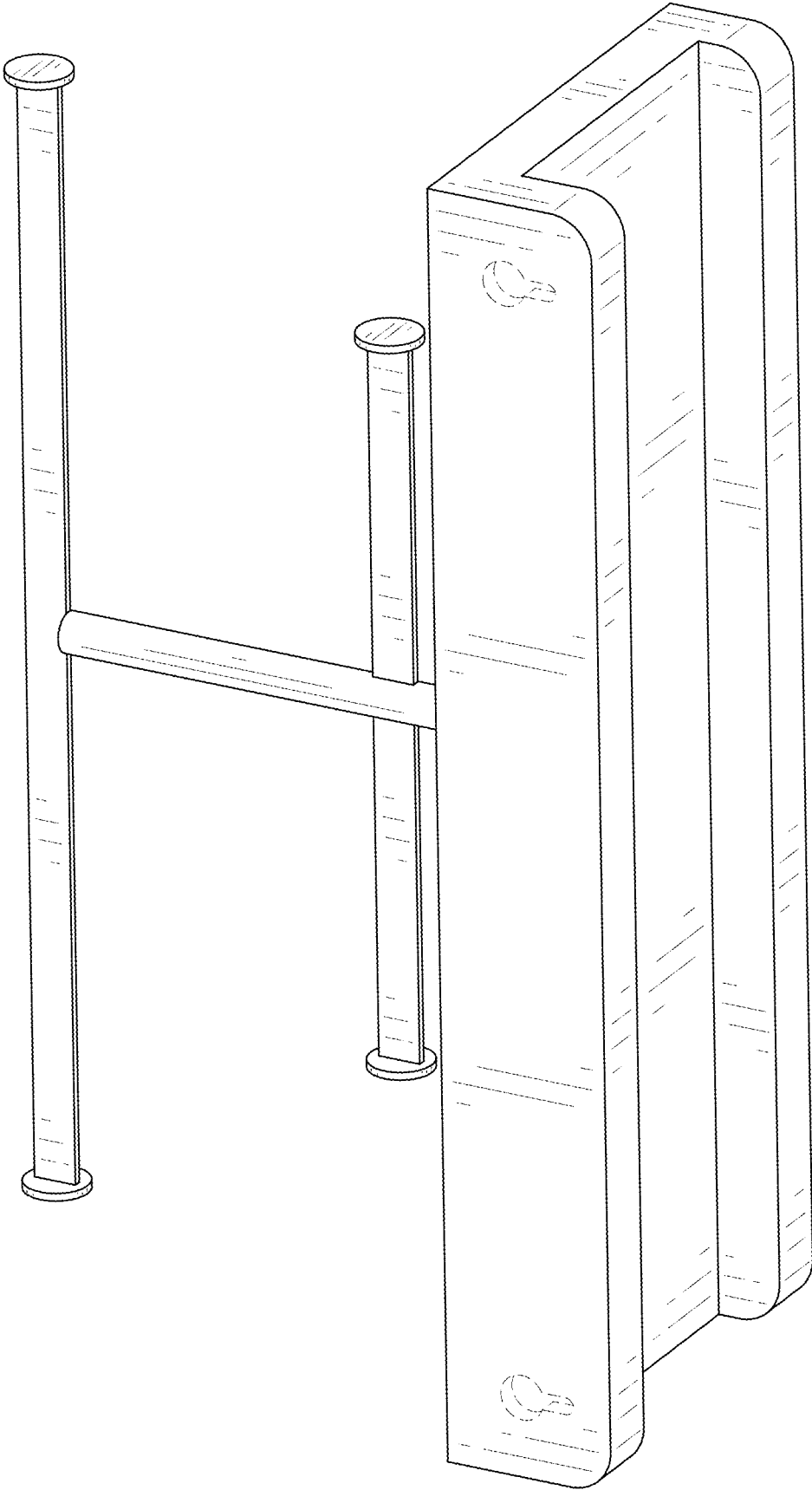

FIG. 2

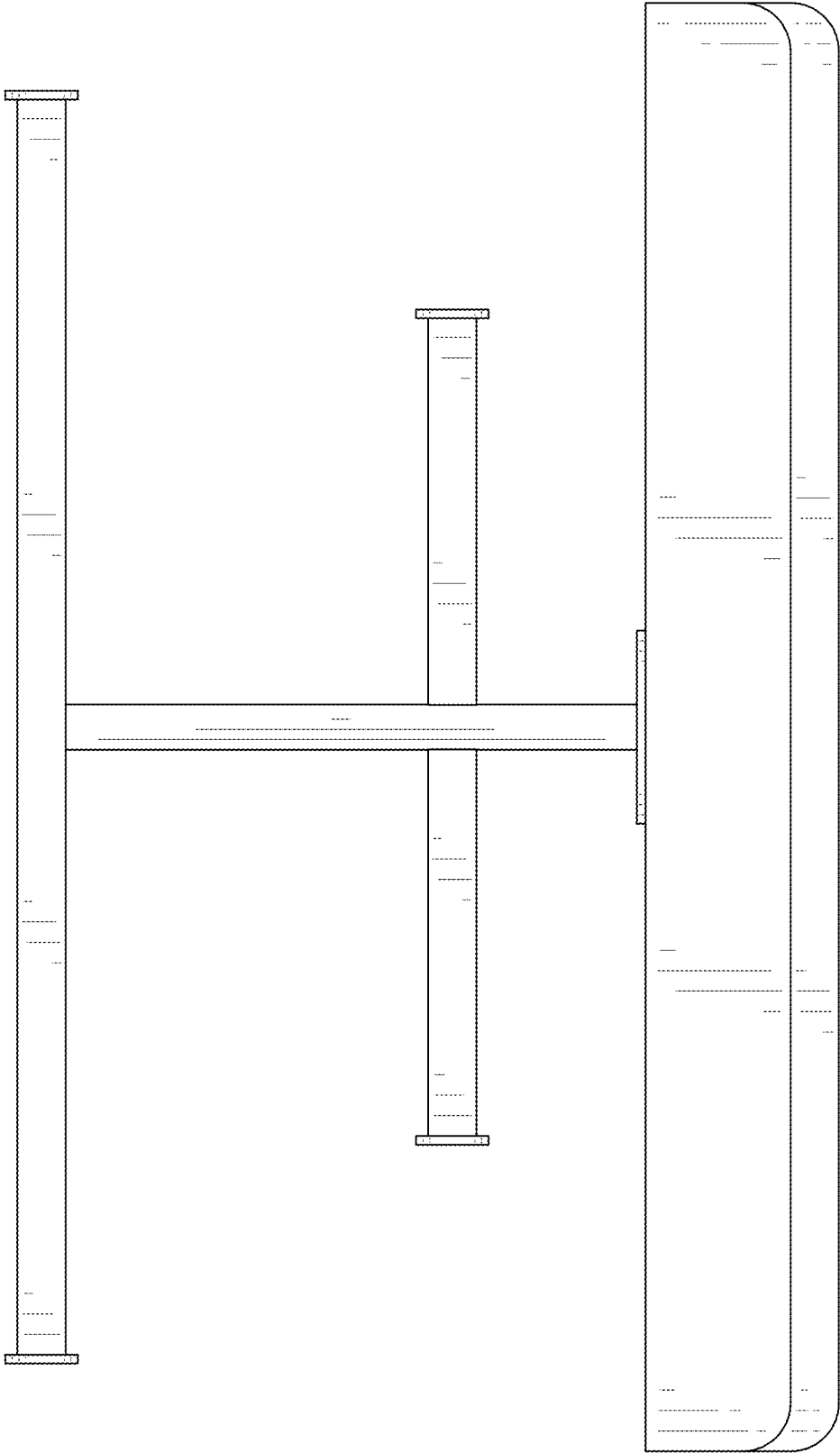

FIG. 3

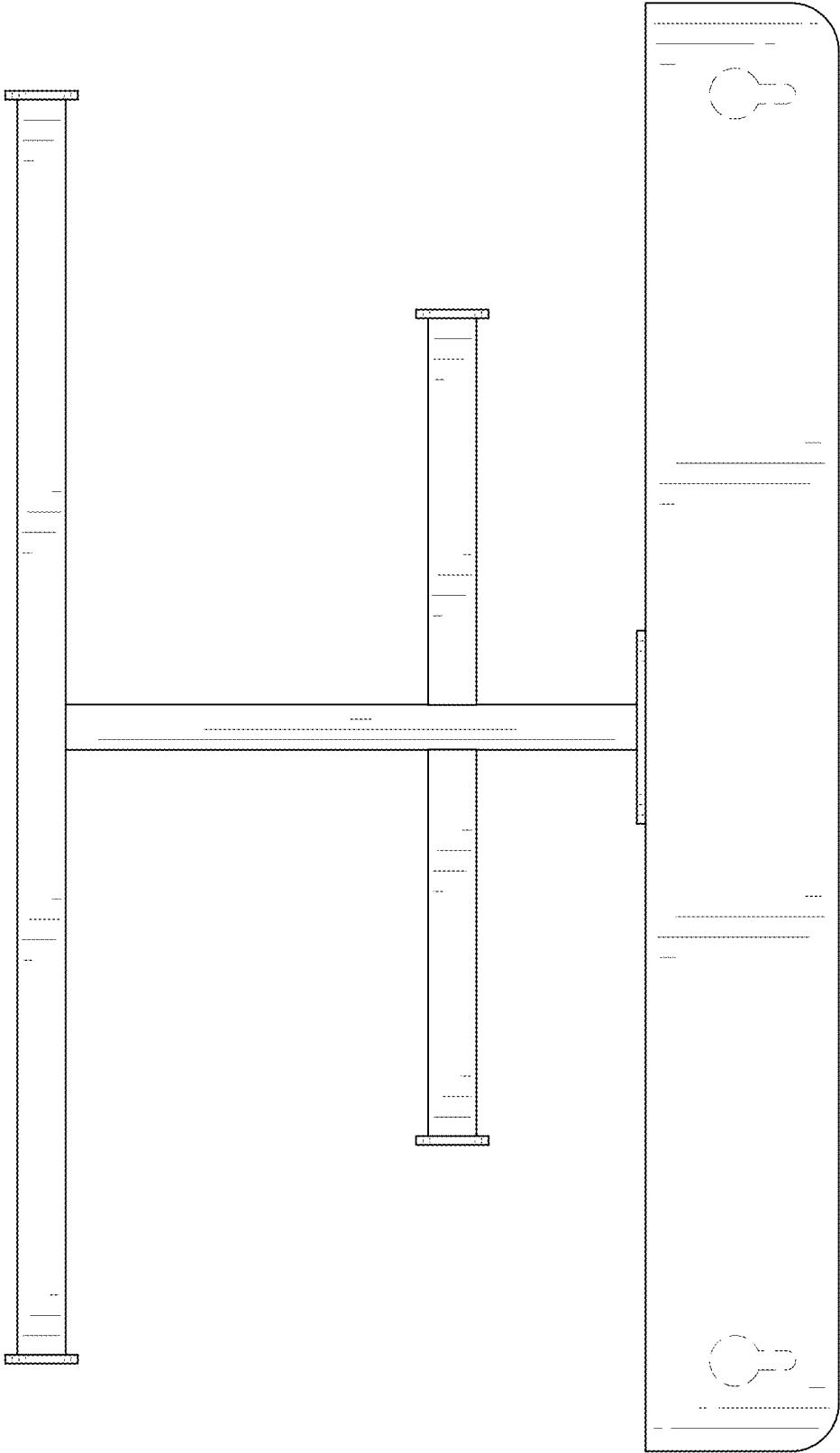

FIG. 4

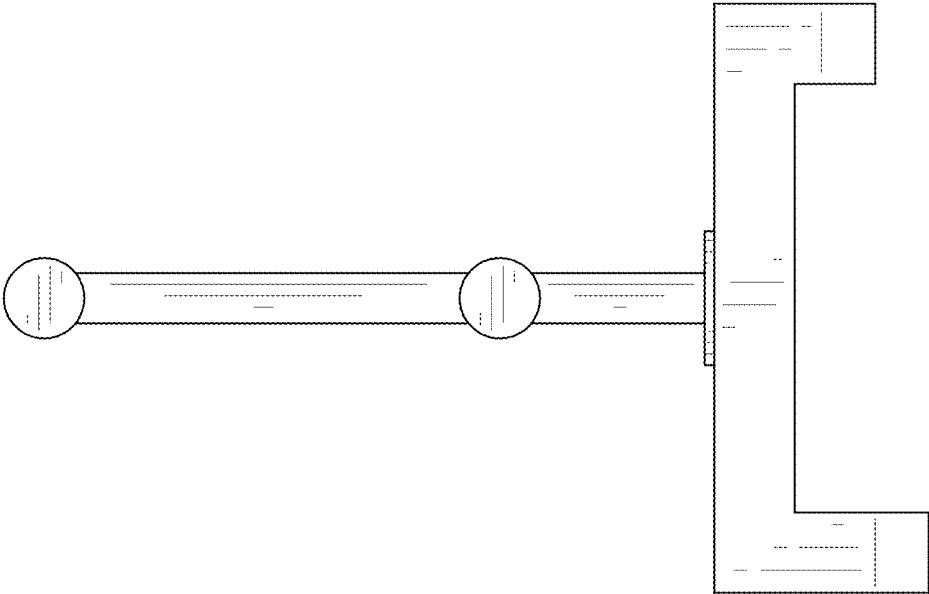

FIG. 5

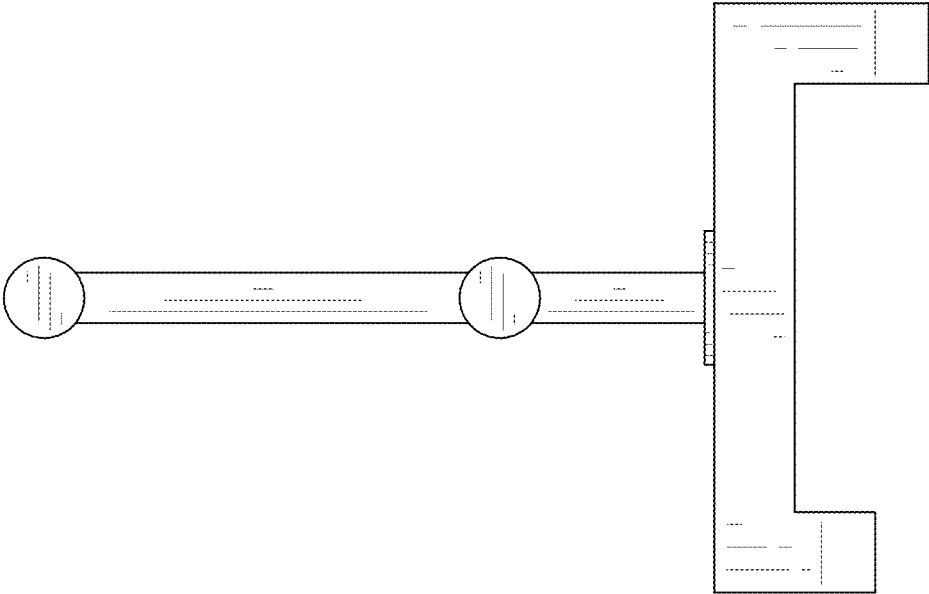

FIG. 6

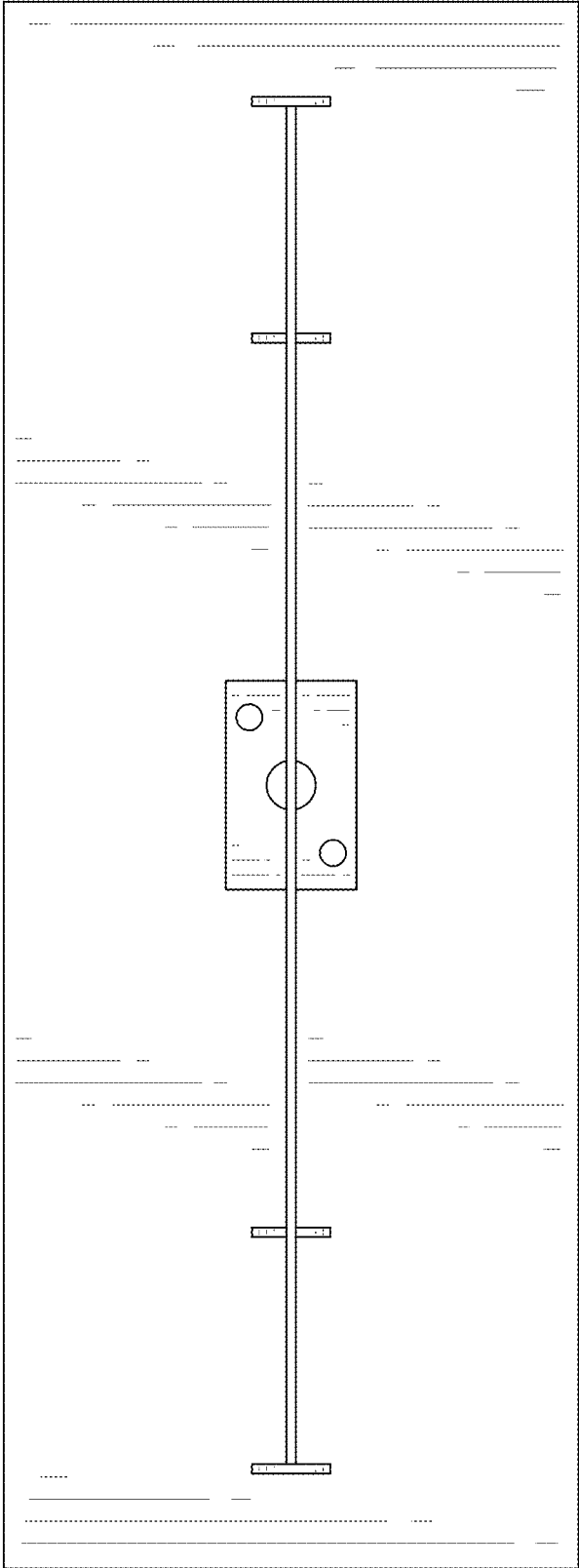

FIG. 7

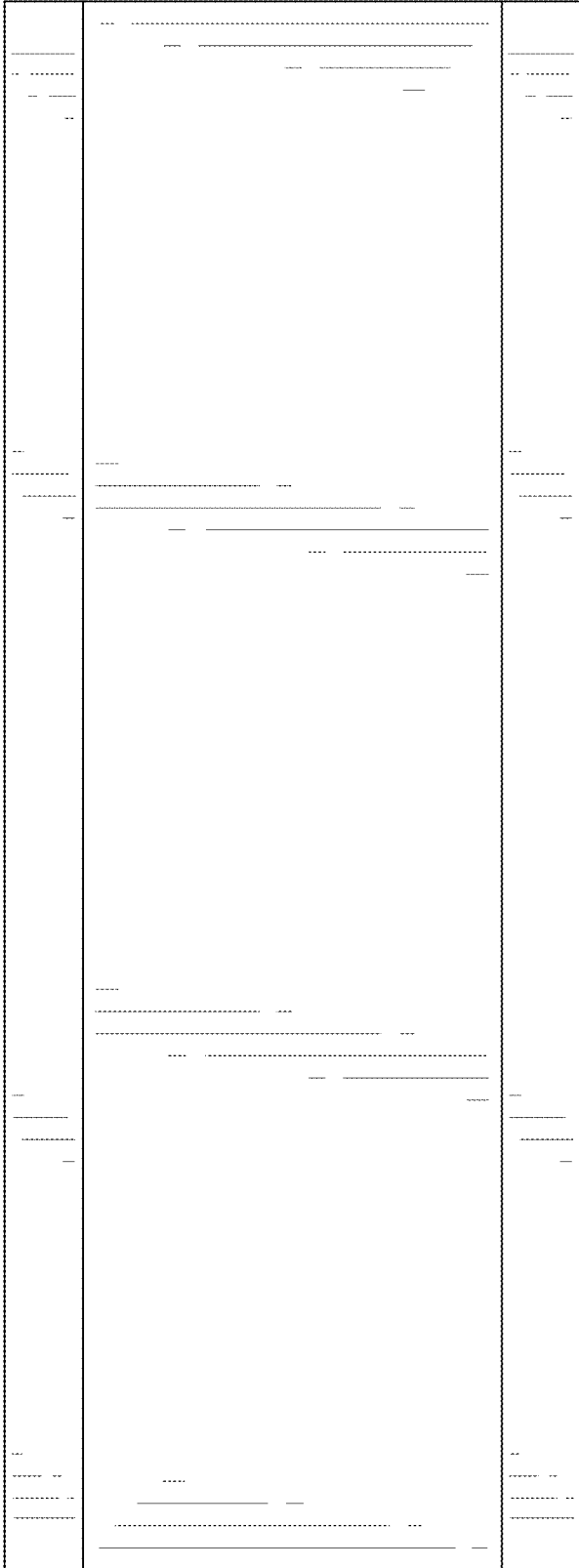

FIG. 8

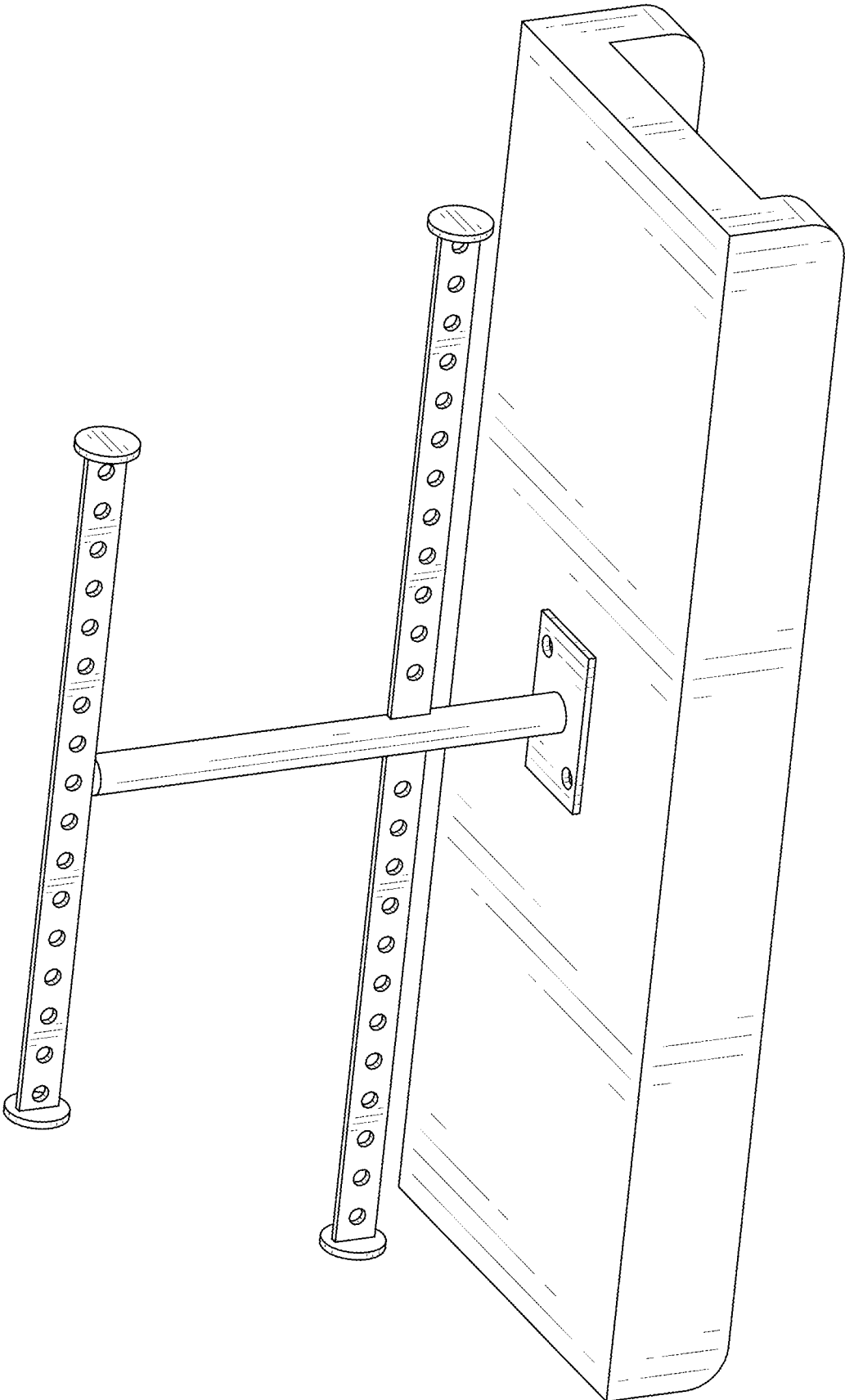

FIG. 9

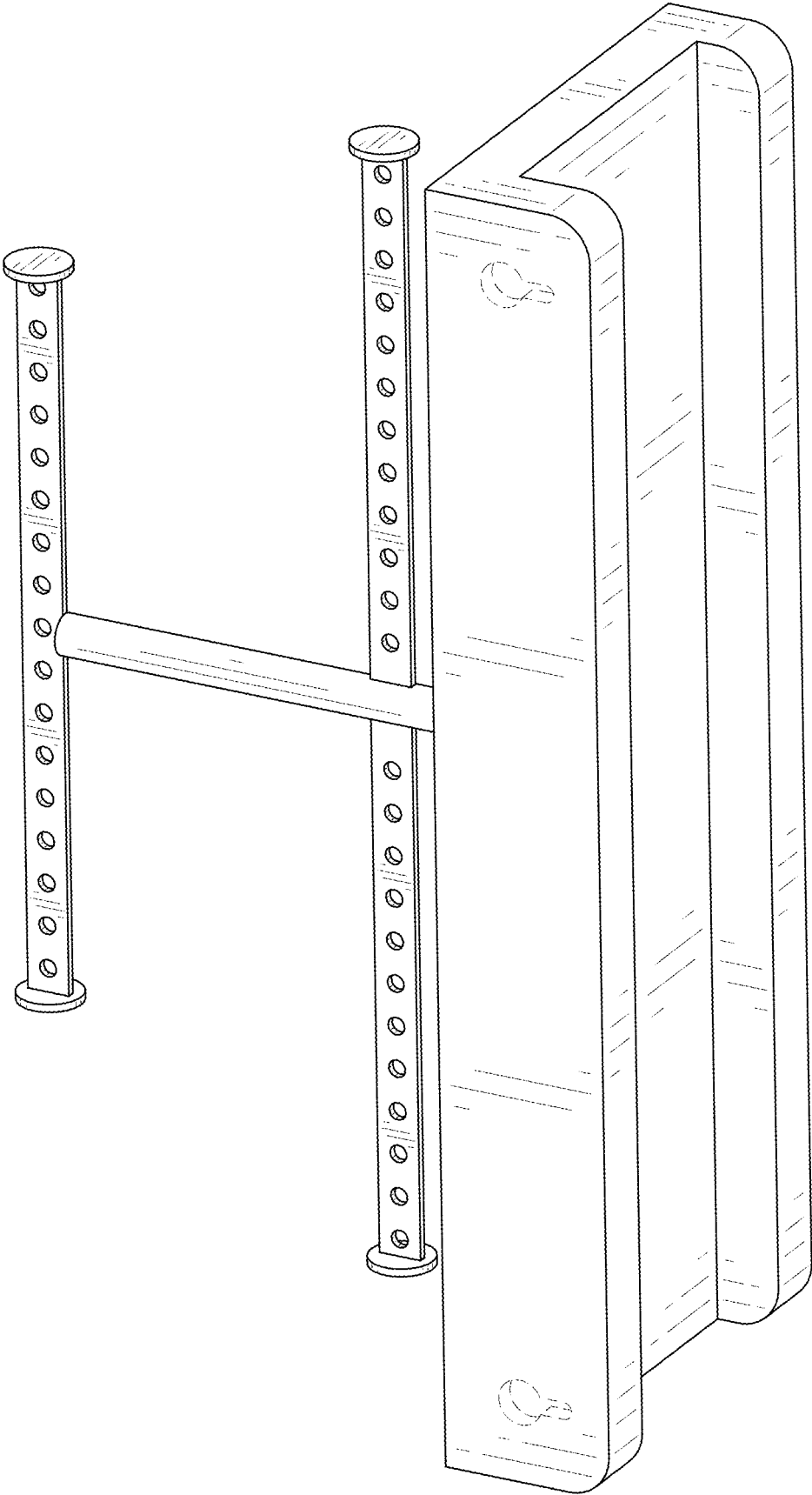

FIG. 10

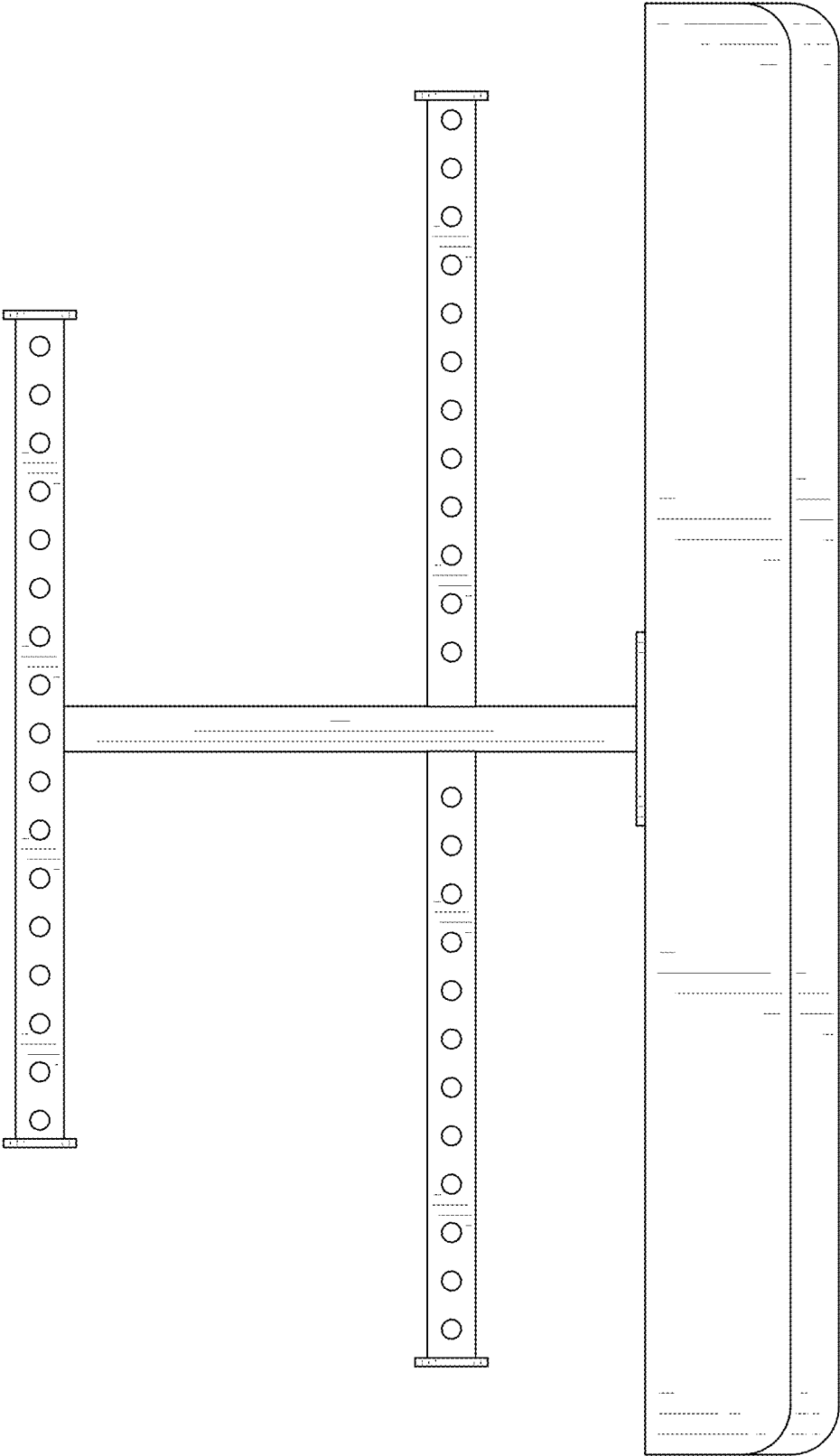

FIG. 11

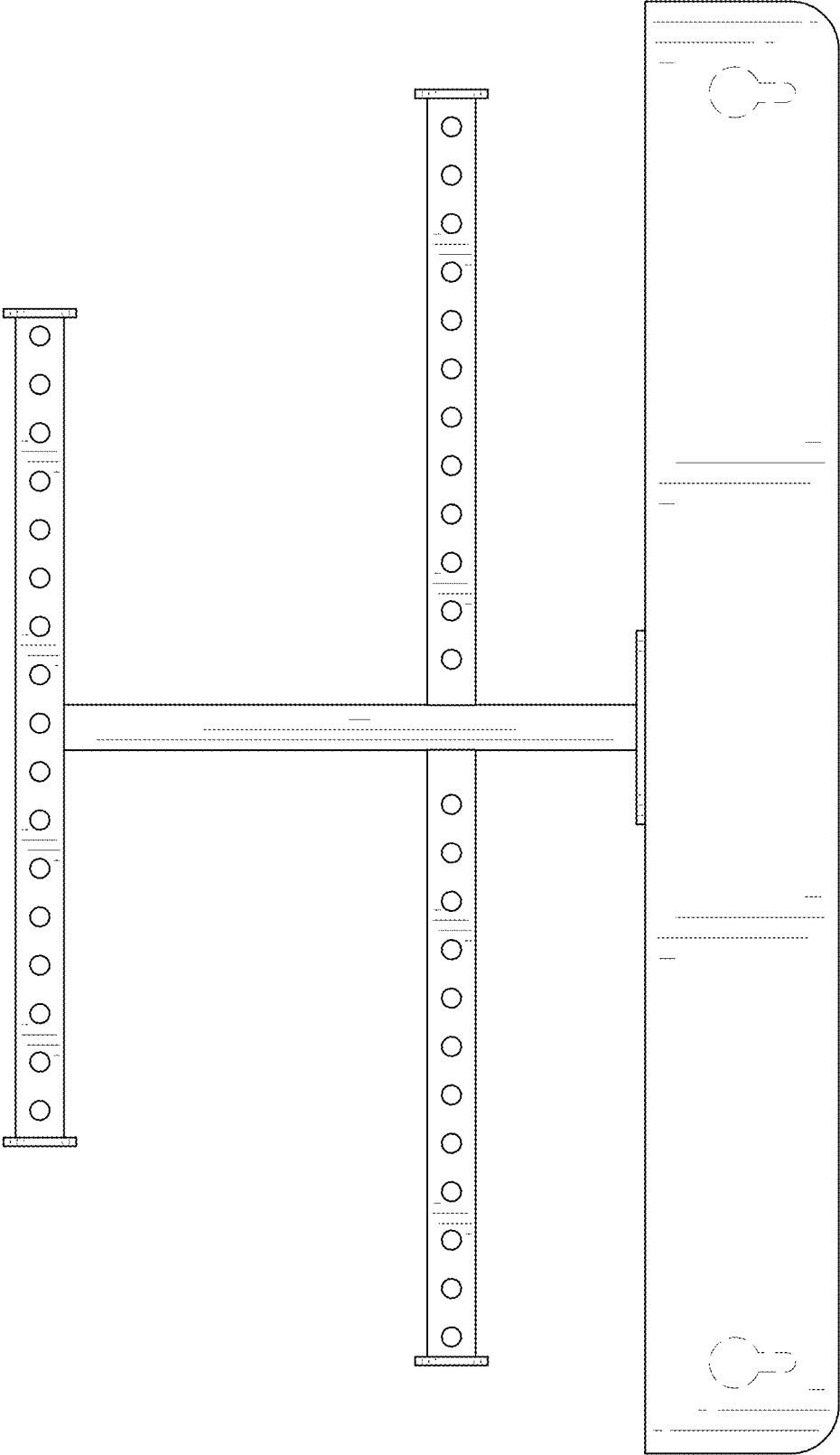

FIG. 12

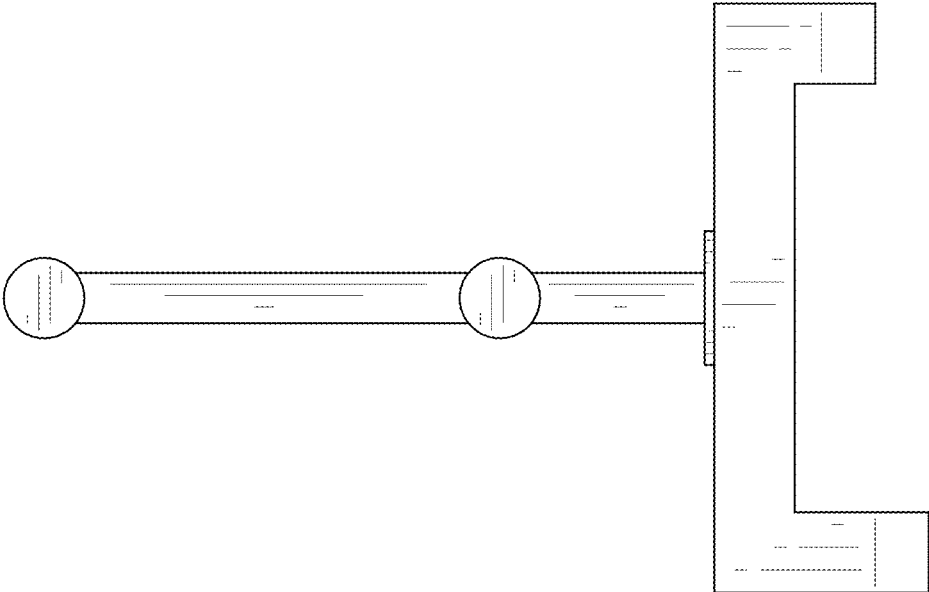

FIG. 13

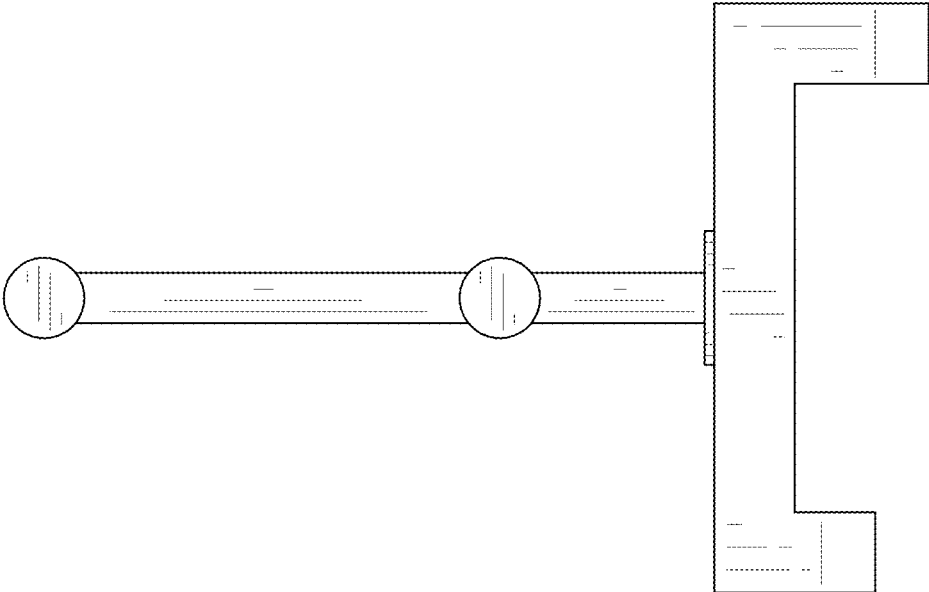

FIG. 14

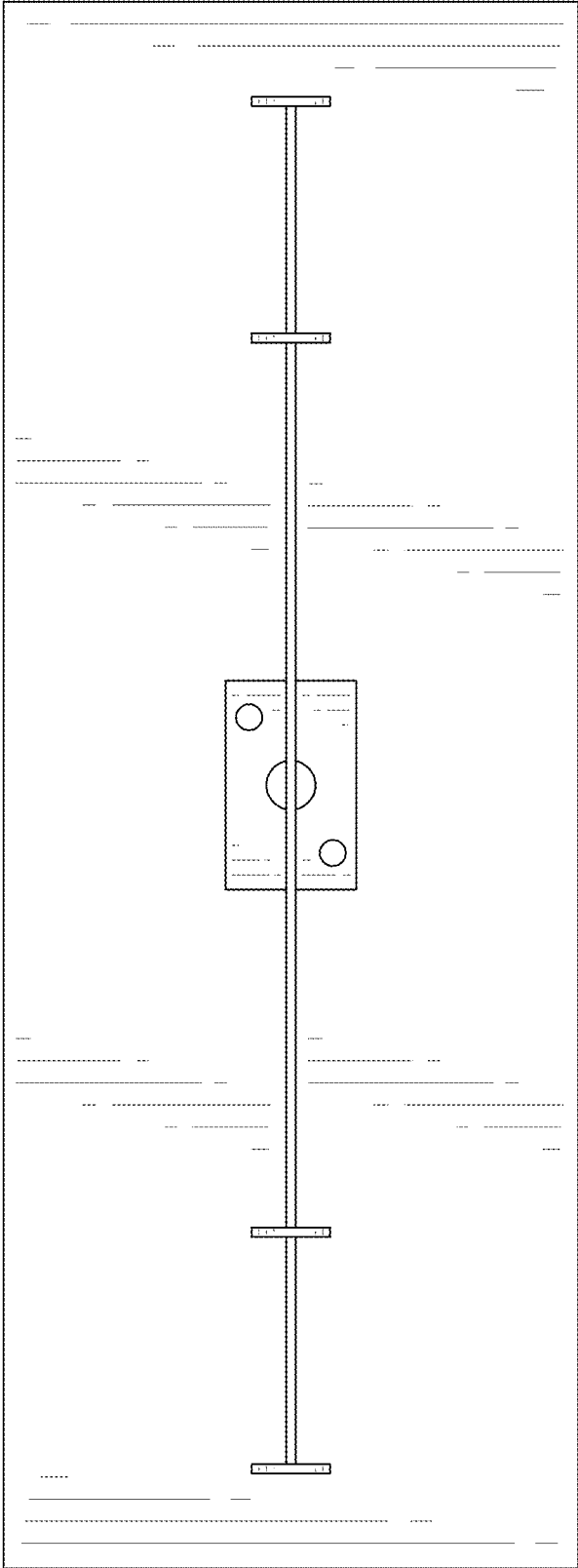

FIG. 15

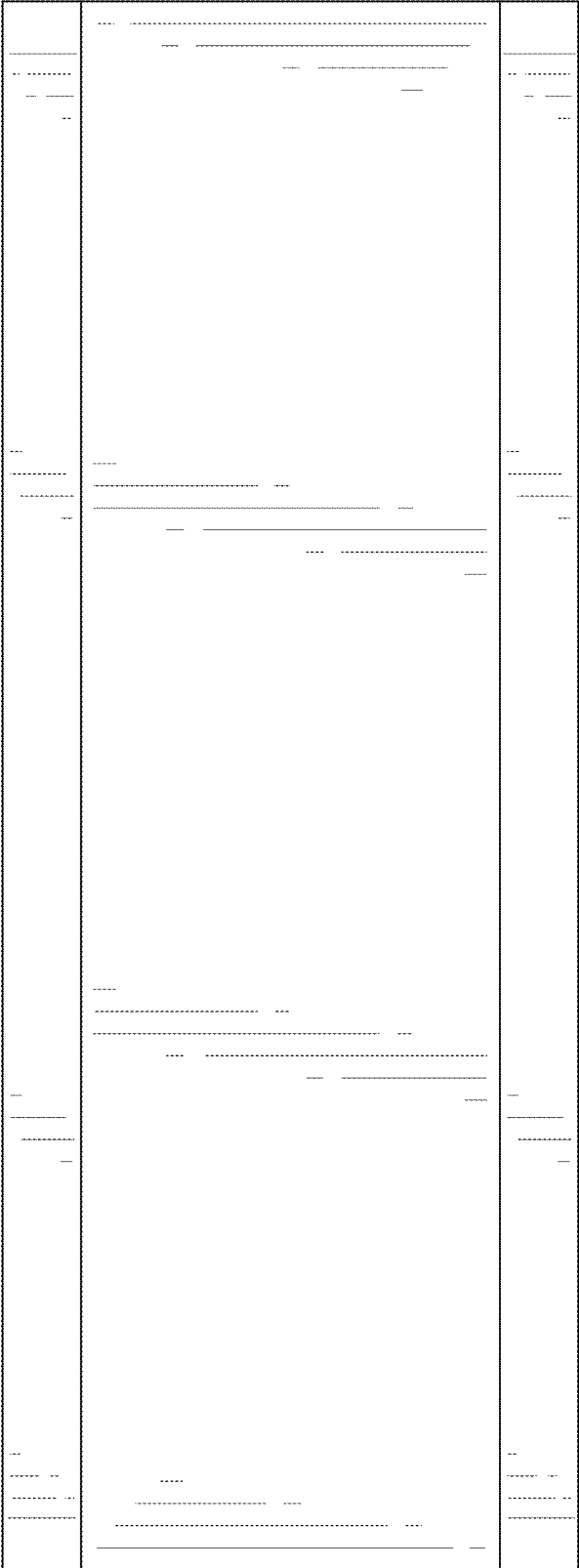

FIG. 16