



US00D862836S

(12) **United States Design Patent**  
**Bauer et al.**

(10) **Patent No.:** **US D862,836 S**

(45) **Date of Patent:** **\*\* Oct. 15, 2019**

(54) **TEXTURED CONFECTIONARY**

**DESCRIPTION**

- (71) Applicant: **WM. WRIGLEY JR. COMPANY**,  
Chicago, IL (US)
- (72) Inventors: **Kari Bauer**, Chicago, IL (US); **Dennis W. Rybolt**, Beecher, IL (US)
- (73) Assignee: **WM. WRIGLEY JR. COMPANY**,  
Chicago, IL (US)
- (\*\*) Term: **15 Years**
- (21) Appl. No.: **29/548,921**
- (22) Filed: **Dec. 17, 2015**
- (51) **LOC (12) Cl.** ..... **01-01**
- (52) **U.S. Cl.** ..... **D1/127**  
USPC ..... **D1/127**
- (58) **Field of Classification Search**  
USPC ..... D1/100–130, 199; 426/5, 76, 87, 92, 94,  
426/95, 99, 101, 103, 108, 138–139, 143,  
(Continued)

FIG. 1 is a front elevation view of a first embodiment of a textured confectionary in accordance with the present design, the rear elevation view being identical thereto;  
 FIG. 2 is a left side elevation view thereof, the right side elevation view, top plan view and bottom plan view being identical thereto;  
 FIG. 3 is a perspective view thereof;  
 FIG. 4 is a front elevational view of a second embodiment of a textured confectionary, the rear elevation view being identical thereto;  
 FIG. 5 is a left side elevation view thereof, the right side elevation view being identical thereto;  
 FIG. 6 is a top plan view thereof, the bottom plan view being identical thereto;  
 FIG. 7 is a perspective view thereof;  
 FIG. 8 is a front elevation view of a third embodiment of a textured confectionary, the rear elevation view being identical thereto;  
 FIG. 9 is a left side elevation view thereof, the right side elevation being identical thereto;  
 FIG. 10 is a top plan view thereof, the bottom plan view being identical thereto;  
 FIG. 11 is a perspective view thereof;  
 FIG. 12 is a front elevation view of a fourth embodiment of a textured confectionary, the rear elevation view being identical thereto;  
 FIG. 13 is a left side elevation view thereof, the right side elevation view being identical thereto;  
 FIG. 14 is a top view thereof, the bottom plan view being identical thereto;  
 FIG. 15 is a perspective view thereof;  
 FIG. 16 is a front elevation view of a fifth embodiment of a textured confectionary, the rear side being identical thereto;  
 FIG. 17 is a left side elevation view thereof, the right side elevational view being identical thereto;  
 FIG. 18 is a top plan view thereof, the bottom plan view being identical thereto; and,  
 FIG. 19 is a perspective view thereof.  
 The shading in the Figures indicates that the surfaces have a glossy surface texture.

(56) **References Cited**

**U.S. PATENT DOCUMENTS**

- D22,882 S \* 11/1893 Roes ..... D1/129
- 787,887 A \* 4/1905 Baker ..... A23G 3/54  
426/103

(Continued)

**OTHER PUBLICATIONS**

“Starburst Minis (Original).” Candyblog. Jun. 21, 2013. Web. May 28, 2019. <[http://www.candyblog.net/blog/item/starburst\\_minis](http://www.candyblog.net/blog/item/starburst_minis)>.\*

*Primary Examiner* — Katie Jane Stofko

(57) **CLAIM**

We claim the ornamental design for a textured confectionary, as substantially shown and described.

**1 Claim, 5 Drawing Sheets**

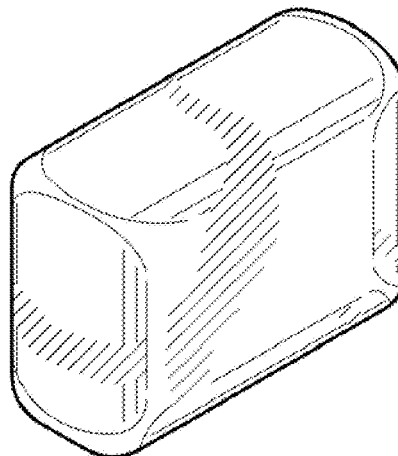
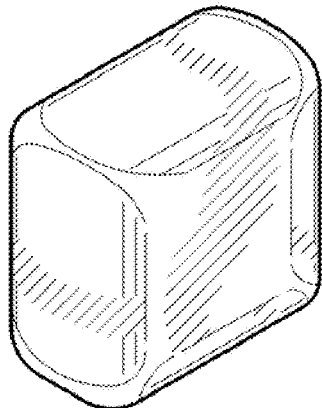

(58) **Field of Classification Search**

USPC ..... 426/144, 279, 282, 283, 391, 514, 549,  
 426/660, 72, 582, 73, 93, 104; D13/100;  
 D24/101-104; D28/8.1; 424/438, 440,  
 424/464, 470-472, 48, 401, 469;  
 425/195; 34/296; D6/601; D10/108;  
 D8/8.1, 8.2; D21/373, 499; D27/100  
 CPC .. A61K 9/2072; A61K 9/0004; A61K 9/2095;  
 A61K 9/209; A23G 4/02; A23G 4/06;  
 A23G 4/08; A23G 4/10; A23G 4/20;  
 A23G 4/00; A23G 3/38; A23G 3/42;  
 A23G 3/54; A23G 3/50; A23G 9/48;  
 A23K 1/164; A23V 2002/00

See application file for complete search history.

(56) **References Cited**

U.S. PATENT DOCUMENTS

1,901,394 A \* 3/1933 Hassell ..... A23G 9/245  
 426/101  
 2,987,445 A \* 6/1961 Levesque ..... A61K 9/2027  
 106/122  
 3,044,938 A \* 7/1962 Halley ..... A61K 9/2077  
 424/470  
 D266,030 S \* 9/1982 Madonia ..... 426/144  
 4,362,751 A \* 12/1982 Dogliotti ..... A23G 3/2015  
 426/94  
 4,563,345 A \* 1/1986 Arrick ..... A23G 4/064  
 424/48  
 4,738,817 A \* 4/1988 Wittwer ..... A61J 3/07  
 106/138.1  
 D295,570 S \* 5/1988 Muello ..... D1/116  
 5,603,219 A \* 2/1997 Kolb ..... F25D 3/08  
 62/1

D425,286 S \* 5/2000 Smoak ..... D1/106  
 6,060,078 A \* 5/2000 Lee ..... A61K 9/0056  
 424/439  
 D478,513 S \* 8/2003 Canamasas Puigbo ..... D9/529  
 D485,421 S \* 1/2004 Norton ..... D1/127  
 6,807,284 B2 \* 10/2004 Nakamura ..... H04R 1/021  
 181/148  
 D509,858 S \* 9/2005 May ..... D21/499  
 D535,741 S \* 1/2007 Stawski ..... D24/101  
 D583,526 S \* 12/2008 Roach ..... D1/128  
 D608,840 S \* 1/2010 Crutchfield ..... D21/373  
 7,968,130 B2 \* 6/2011 Walter ..... A21D 2/02  
 426/496  
 D658,823 S \* 5/2012 Viola ..... D30/160  
 8,455,025 B2 \* 6/2013 Stern ..... A01K 15/026  
 426/516  
 8,557,323 B2 \* 10/2013 Stawski ..... A23G 3/34  
 424/440  
 D723,766 S \* 3/2015 Kamakura ..... D1/127  
 D724,778 S \* 3/2015 Hulan ..... D24/100  
 9,498,435 B2 \* 11/2016 Allio ..... A61K 36/9066  
 D778,525 S \* 2/2017 Gao ..... D1/127  
 D838,930 S \* 1/2019 Kamper ..... D1/128  
 2003/0163149 A1 \* 8/2003 Heisinger, Jr. .... A23G 1/30  
 606/161  
 2007/0160713 A1 \* 7/2007 Walter ..... A21D 2/02  
 426/73  
 2007/0231426 A1 \* 10/2007 Acar ..... A23G 4/20  
 426/5  
 2009/0202673 A1 \* 8/2009 Phillips ..... A23G 1/54  
 426/5  
 2011/0045726 A1 \* 2/2011 Donovan ..... C08L 33/26  
 442/86  
 2013/0071454 A1 \* 3/2013 Stawski ..... A23G 3/34  
 424/401

\* cited by examiner

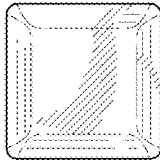

FIG. 1



FIG. 2

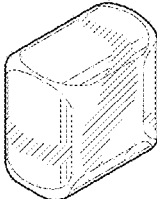

FIG. 3

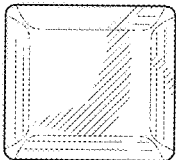

FIG. 4



FIG. 5



FIG. 6

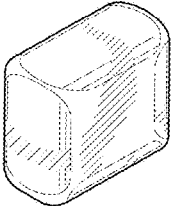

FIG. 7

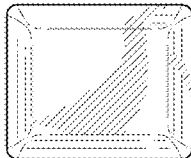

FIG. 8



FIG. 9

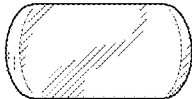

FIG. 10

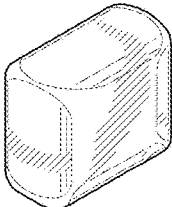

FIG. 11

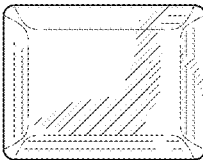

FIG. 12



FIG. 13



FIG. 14

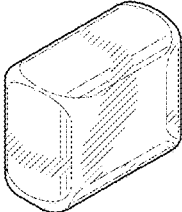

FIG. 15

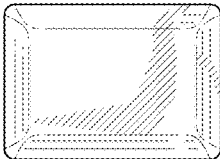

FIG. 16



FIG. 17



FIG. 18

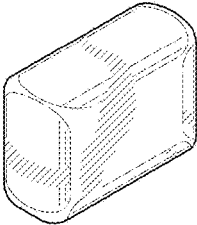

FIG. 19