



US0D1028518S

(12) **United States Design Patent**
Hsu

(10) **Patent No.:** **US D1,028,518 S**

(45) **Date of Patent:** **** May 28, 2024**

- (54) **CONTAINER**
- (71) Applicant: **L&F PLASTICS, CO., LTD.**, Miaoli County (TW)
- (72) Inventor: **Mu-Chuan Hsu**, Miaoli County (TW)
- (73) Assignee: **L&F Plastics, Co., Ltd.**, Miaoli County (TW)
- (**) Term: **15 Years**
- (21) Appl. No.: **29/783,314**
- (22) Filed: **May 12, 2021**
- (30) **Foreign Application Priority Data**

D785,326 S *	5/2017	Yamamoto	D3/297
D785,329 S *	5/2017	Yamamoto	D3/297
D855,321 S *	8/2019	Yamamoto	D3/297
D977,837 S *	2/2023	Dai	A47B 88/9418 D3/298

- Nov. 18, 2020 (TW) 109306432
- (51) **LOC (14) Cl.** **03-01**
- (52) **U.S. Cl.**
USPC **D3/297**
- (58) **Field of Classification Search**
USPC D3/271.6, 271.11, 273, 274, 276, 282,
D3/289, 294, 296, 305, 302, 287, 900,
D3/203.1, 203.2, 902, 279, 297
CPC B65D 21/0209; B65D 21/0215; B65D
21/023; B65D 50/04; B65D 2251/1083;
B65D 11/18; A45C 3/02; A63H 33/425;
A63H 27/005
See application file for complete search history.

OTHER PUBLICATIONS

Amazon, "Iris USA 6 Quart Compact Stacking Storage Drawer", First review Oct. 3, 2020. (<https://www.amazon.com/IRIS-USA-Inc-Compact-Stacking/dp/B083JXHCR3?th=1>) (Year: 2020).*

* cited by examiner

Primary Examiner — April Rivas
(74) *Attorney, Agent, or Firm* — Millen, White, Zelano & Branigan P.C.; Wan-Ching Montfort

- (56) **References Cited**
U.S. PATENT DOCUMENTS
D243,900 S * 4/1977 Boyd D3/297
D518,708 S * 4/2006 Ohayon D6/705

(57) **CLAIM**
The ornamental design for a container, as shown and described.

DESCRIPTION

FIG. 1 is a top front perspective view of a container showing our new design;
FIG. 2 is a front view thereof;
FIG. 3 is a rear view thereof;
FIG. 4 is a right side view thereof and the left side view being a mirror image;
FIG. 5 is a top view thereof;
FIG. 6 is a bottom view thereof; and,
FIG. 7 is a bottom rear perspective view thereof.
The broken lines illustrate portions of the container and form no part of the claimed design.

1 Claim, 6 Drawing Sheets

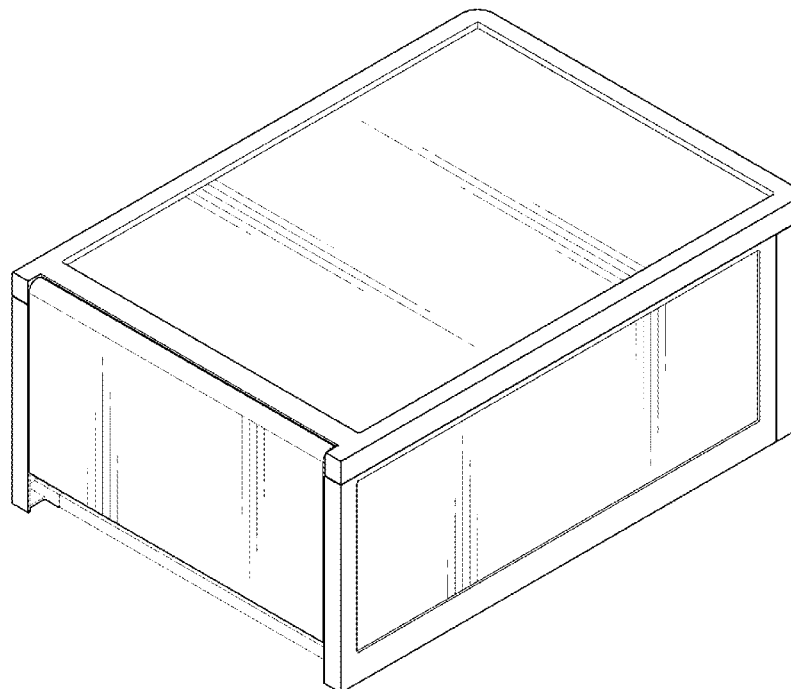

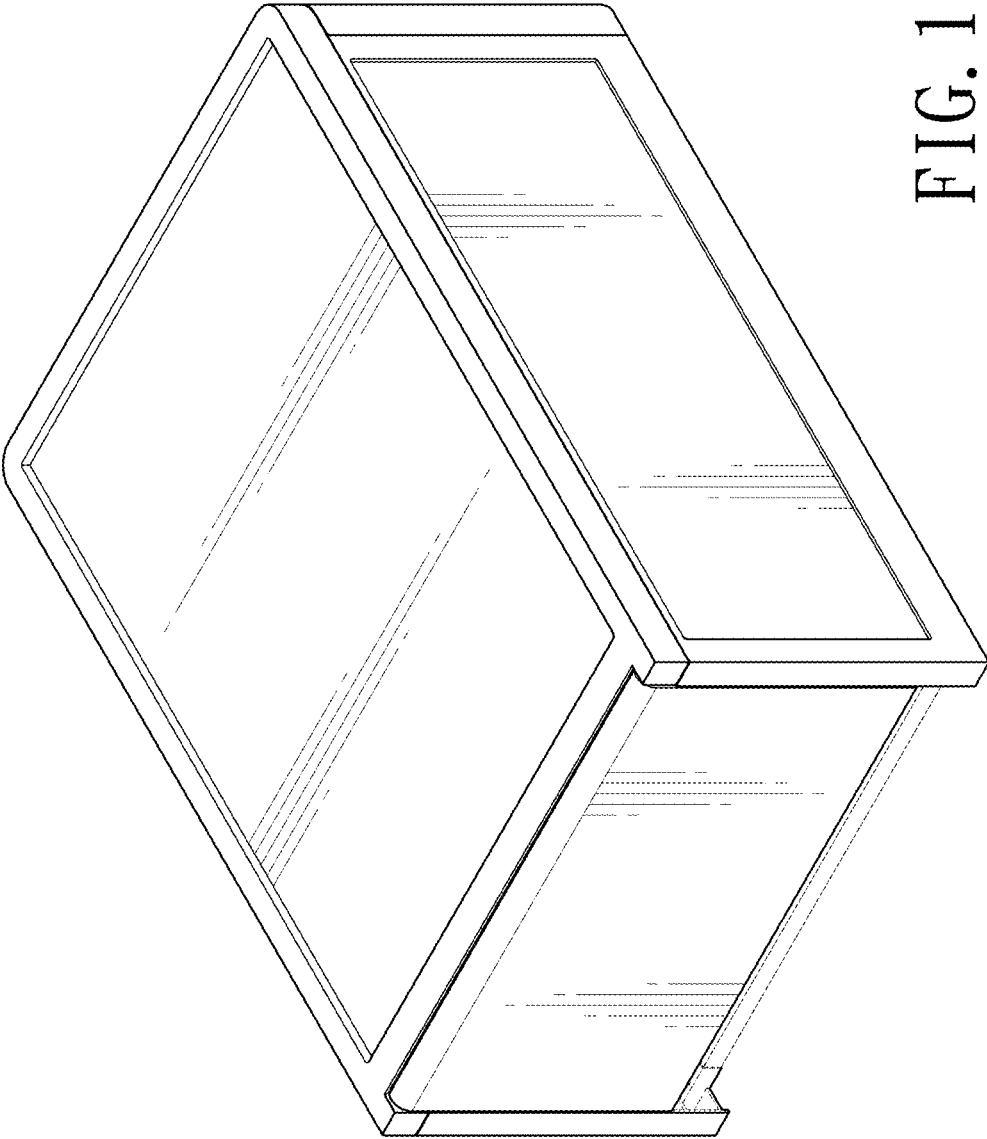

FIG. 1

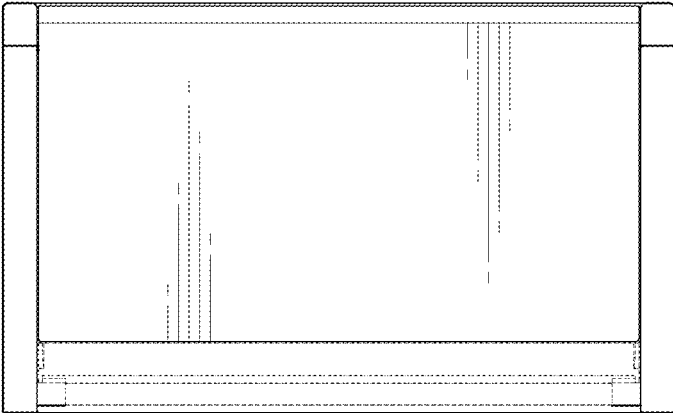

FIG. 2

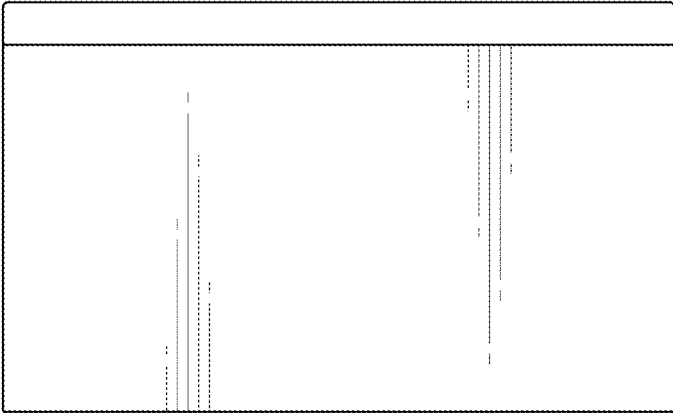

FIG. 3

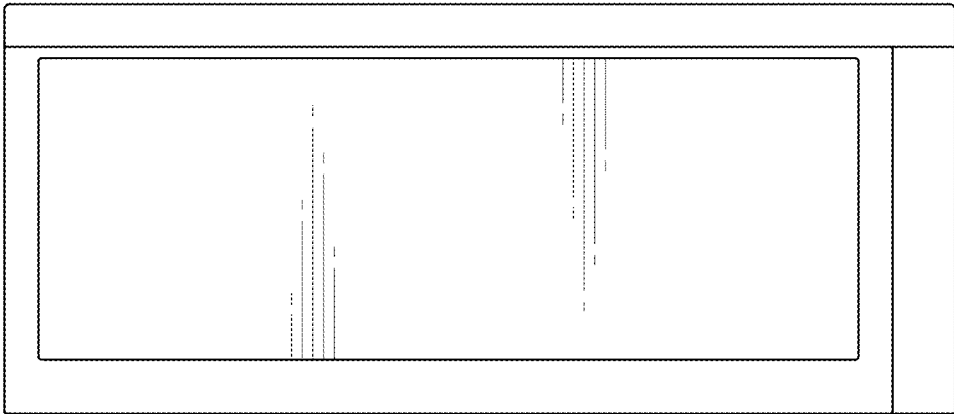

FIG. 4

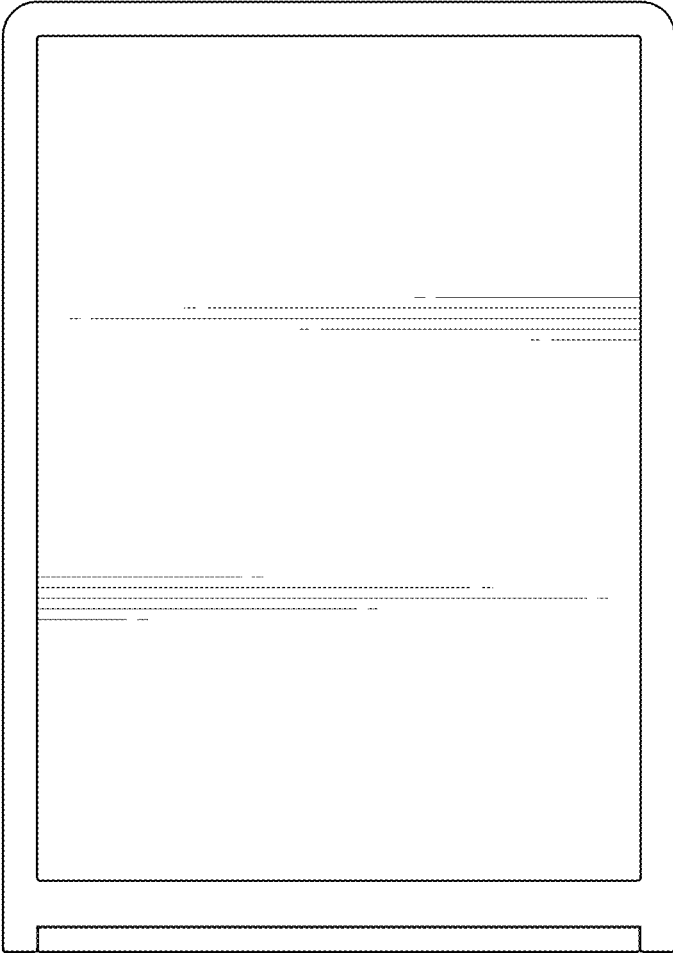

FIG. 5

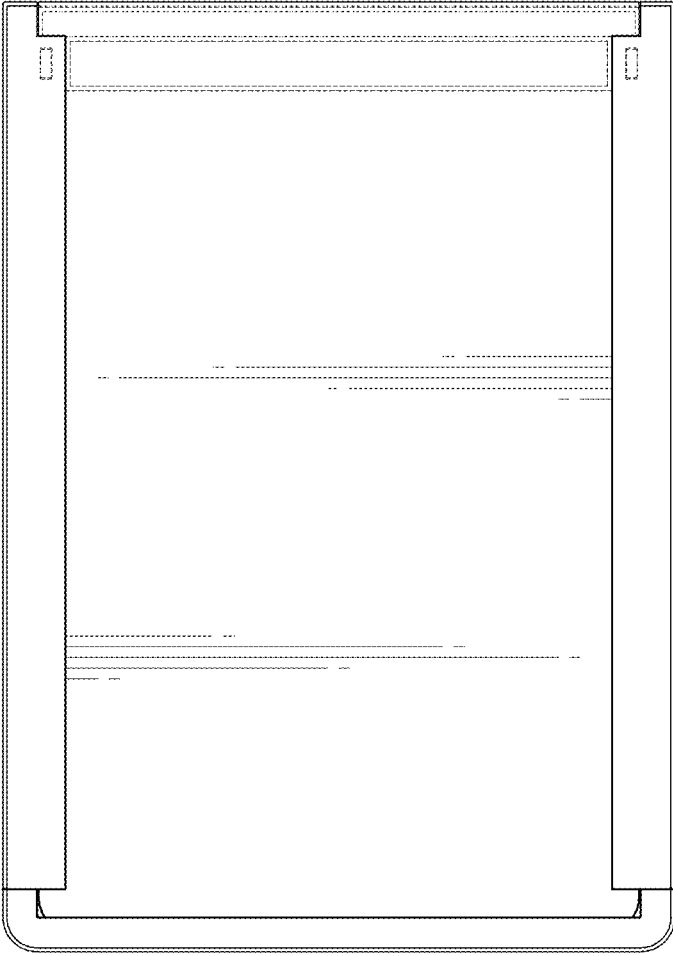

FIG. 6

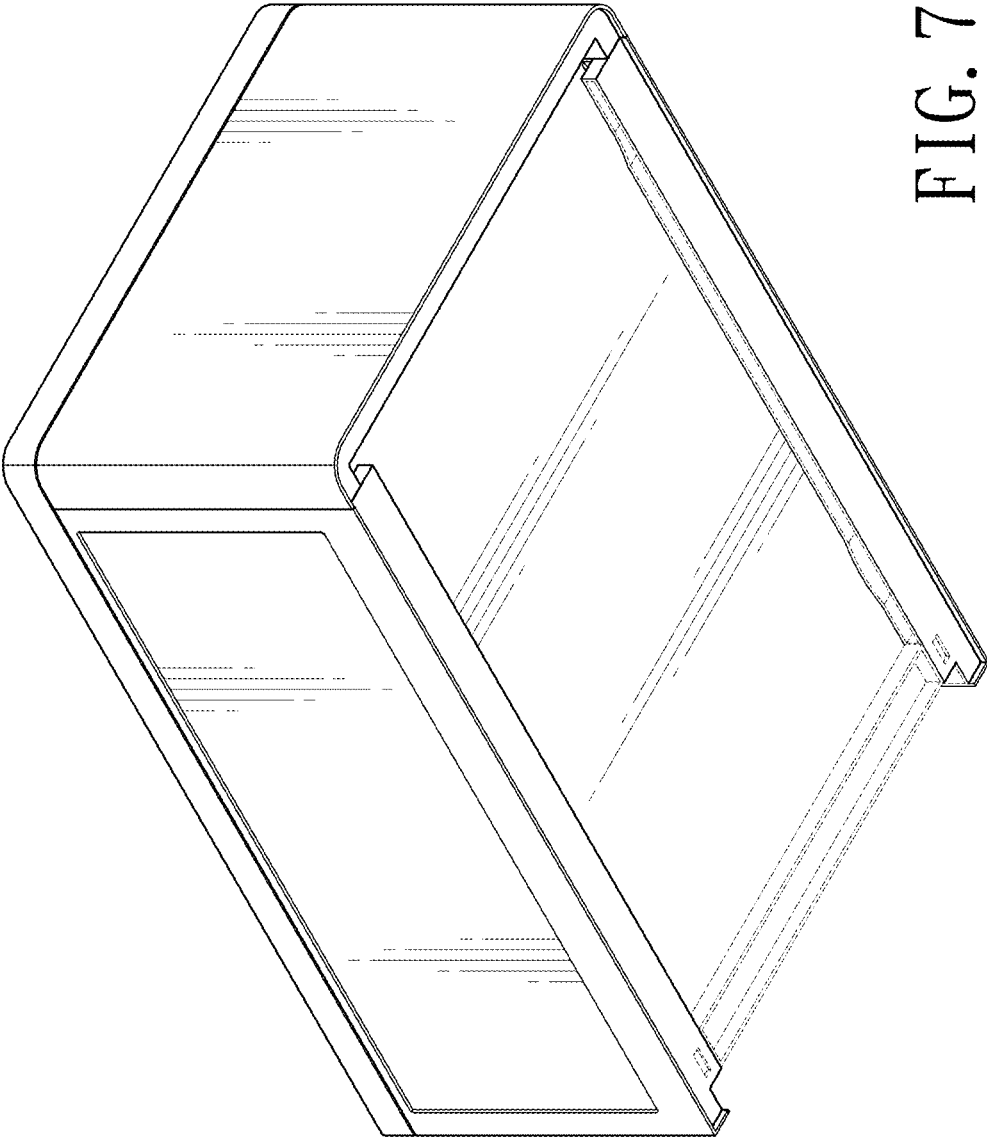

FIG. 7